



Chipsmall Limited consists of a professional team with an average of over 10 year of expertise in the distribution of electronic components. Based in Hongkong, we have already established firm and mutual-benefit business relationships with customers from,Europe,America and south Asia,supplying obsolete and hard-to-find components to meet their specific needs.

With the principle of "Quality Parts,Customers Priority,Honest Operation,and Considerate Service",our business mainly focus on the distribution of electronic components. Line cards we deal with include Microchip,ALPS,ROHM,Xilinx,Pulse,ON,Everlight and Freescale. Main products comprise IC,Modules,Potentiometer,IC Socket,Relay,Connector.Our parts cover such applications as commercial,industrial, and automotives areas.

We are looking forward to setting up business relationship with you and hope to provide you with the best service and solution. Let us make a better world for our industry!



## Contact us

Tel: +86-755-8981 8866 Fax: +86-755-8427 6832

Email & Skype: info@chipsmall.com Web: www.chipsmall.com

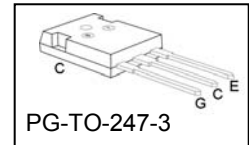
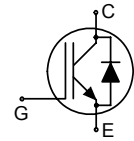
Address: A1208, Overseas Decoration Building, #122 Zhenhua RD., Futian, Shenzhen, China



## Reverse Conducting IGBT with monolithic body diode

**Features:**

- Powerful monolithic Body Diode with very low forward voltage
- Body diode clamps negative voltages
- Trench and Fieldstop technology for 1200 V applications offers :
  - very tight parameter distribution
  - high ruggedness, temperature stable behavior
- Low EMI
- Qualified according to JEDEC<sup>1</sup> for target applications
- Pb-free lead plating; RoHS compliant
- Complete product spectrum and PSpice Models :  
<http://www.infineon.com/igbt/>


**Applications:**

- Inductive Cooking
- Soft Switching Applications

Type	$V_{CE}$	$I_C$	$V_{CE(sat), T_j=25^\circ C}$	$T_{j,max}$	Marking	Package
IHW15N120R2	1200V	15A	1.5V	175°C	H15R1202	PG-TO-247-3

**Maximum Ratings**

Parameter	Symbol	Value	Unit
Collector-emitter voltage	$V_{CE}$	1200	V
DC collector current $T_C = 25^\circ C$ $T_C = 100^\circ C$	$I_C$	30 15	A
Pulsed collector current, $t_p$ limited by $T_{j,max}$	$I_{C,puls}$	45	
Turn off safe operating area ( $V_{CE} \leq 1200V$ , $T_j \leq 175^\circ C$ )	-	45	
Diode forward current $T_C = 25^\circ C$ $T_C = 100^\circ C$	$I_F$	30 15	
Diode pulsed current, $t_p$ limited by $T_{j,max}$	$I_{F,puls}$	45	
Diode surge non repetitive current, $t_p$ limited by $T_{j,max}$ $T_C = 25^\circ C$ , $t_p = 10ms$ , sine halfwave $T_C = 25^\circ C$ , $t_p \leq 2.5\mu s$ , sine halfwave $T_C = 100^\circ C$ , $t_p \leq 2.5\mu s$ , sine halfwave	$I_{FSM}$	50 130 120	
Gate-emitter voltage	$V_{GE}$	$\pm 20$	V
Transient Gate-emitter voltage ( $t_p < 5 ms$ )		$\pm 25$	
Power dissipation $T_C = 25^\circ C$	$P_{tot}$	357	W
Operating junction temperature	$T_j$	-40...+175	°C
Storage temperature	$T_{stg}$	-55...+175	
Soldering temperature, 1.6mm (0.063 in.) from case for 10s	-	260	
Mounting Torque	$M_s$	0.6	Nm

<sup>1</sup> J-STD-020 and JESD-022

### Thermal Resistance

Parameter	Symbol	Conditions	Max. Value	Unit
<b>Characteristic</b>				
IGBT thermal resistance, junction – case	$R_{thJC}$		0.52	K/W
Diode thermal resistance, junction – case	$R_{thJCD}$		0.47	
Thermal resistance, junction – ambient	$R_{thJA}$		40	

### Electrical Characteristic, at $T_j = 25^\circ\text{C}$ , unless otherwise specified

Parameter	Symbol	Conditions	Value			Unit
			min.	typ.	max.	
<b>Static Characteristic</b>						
Collector-emitter breakdown voltage	$V_{(BR)CES}$	$V_{GE}=0V, I_C=500\mu A$	1200	-	-	V
Collector-emitter saturation voltage	$V_{CE(sat)}$	$V_{GE} = 15V, I_C=15A$ $T_j=25^\circ\text{C}$ $T_j=125^\circ\text{C}$ $T_j=175^\circ\text{C}$	- - -	1.5 1.7 1.8	1.75 - -	
Diode forward voltage	$V_F$	$V_{GE}=0V, I_F=15A$ $T_j=25^\circ\text{C}$ $T_j=125^\circ\text{C}$ $T_j=175^\circ\text{C}$	- - -	1.45 1.55 1.6	1.65 - -	
Gate-emitter threshold voltage	$V_{GE(th)}$	$I_C=0.4mA,$ $V_{CE}=V_{GE}$	5.1	5.8	6.4	
Zero gate voltage collector current	$I_{CES}$	$V_{CE}=1200V,$ $V_{GE}=0V$ $T_j=25^\circ\text{C}$ $T_j=175^\circ\text{C}$	- -	- -	5 2500	$\mu A$
Gate-emitter leakage current	$I_{GES}$	$V_{CE}=0V, V_{GE}=20V$	-	-	100	nA
Transconductance	$g_{fs}$	$V_{CE}=20V, I_C=15A$	-	11.7	-	S
Integrated gate resistor	$R_{Gint}$			none		$\Omega$

### Dynamic Characteristic

Input capacitance	$C_{iss}$	$V_{CE}=25V,$ $V_{GE}=0V,$ $f=1MHz$	-	1530	-	pF
Output capacitance	$C_{oss}$		-	49	-	
Reverse transfer capacitance	$C_{rss}$		-	39	-	
Gate charge	$Q_{Gate}$	$V_{CC}=960V, I_C=15A$ $V_{GE}=15V$	-	133	-	nC
Internal emitter inductance measured 5mm (0.197 in.) from case	$L_E$		-	13	-	nH

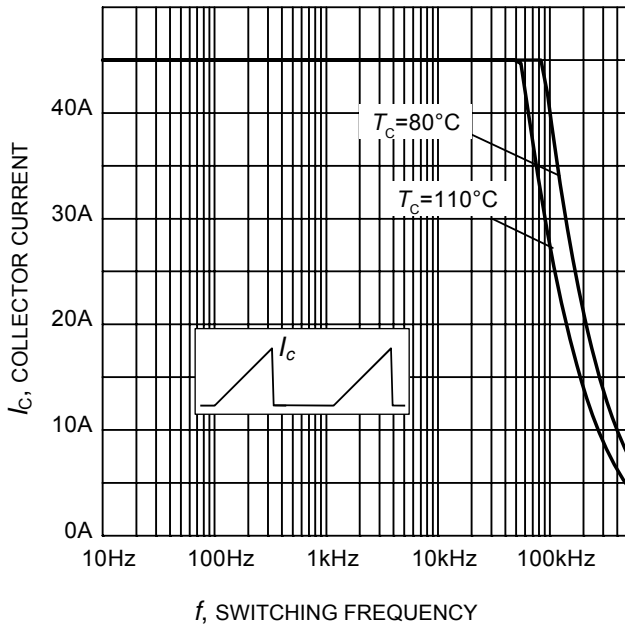
### Switching Characteristic, Inductive Load, at $T_j=25^\circ C$

Parameter	Symbol	Conditions	Value			Unit
			min.	typ.	max.	
<b>IGBT Characteristic</b>						
Turn-off delay time	$t_{d(off)}$	$T_j=25^\circ C,$ $V_{CC}=600V, I_C=15A$ $V_{GE}=0 / 15V,$ $R_G=14.8\Omega,$ $L_\sigma^{(2)}=230nH,$ $C_\sigma^{(2)}=39pF$	-	282	-	
Fall time	$t_f$		-	62	-	
Turn-off energy	$E_{off}$		-	0.9	-	
Total switching energy	$E_{ts}$		-	0.9	-	

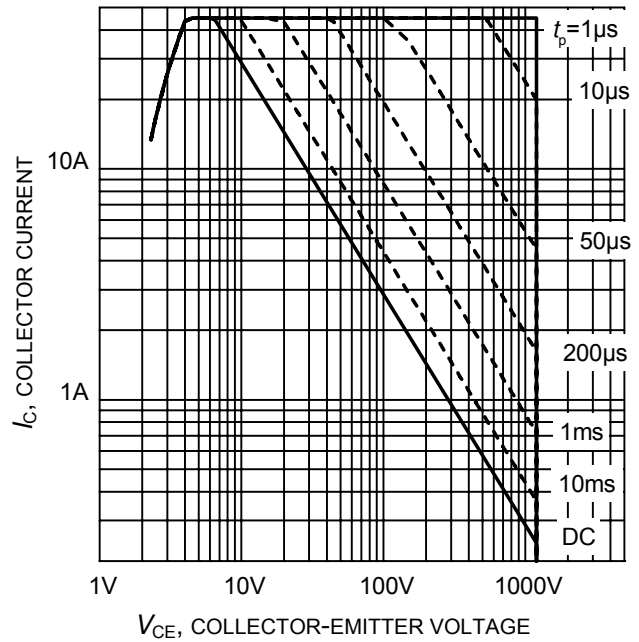
### Switching Characteristic, Inductive Load, at $T_j=175^\circ C$

Parameter	Symbol	Conditions	Value			Unit
			min.	typ.	max.	
<b>IGBT Characteristic</b>						
Turn-off delay time	$t_{d(off)}$	$T_j=175^\circ C$ $V_{CC}=600V, I_C=15A,$ $V_{GE}=0 / 15V,$ $R_G=14.8\Omega,$ $L_\sigma=230nH^{(2)},$ $C_\sigma=39pF^{(2)}$	-	342	-	
Fall time	$t_f$		-	90	-	
Turn-off energy	$E_{off}$		-	1.3	-	
Total switching energy	$E_{ts}$		-	1.3	-	

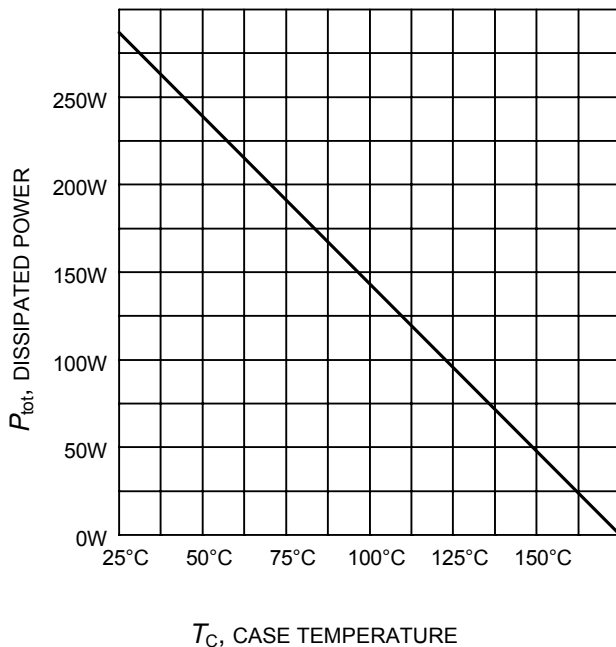
<sup>2)</sup> Leakage inductance  $L_\sigma$  and Stray capacity  $C_\sigma$  due to dynamic test circuit in Figure E.



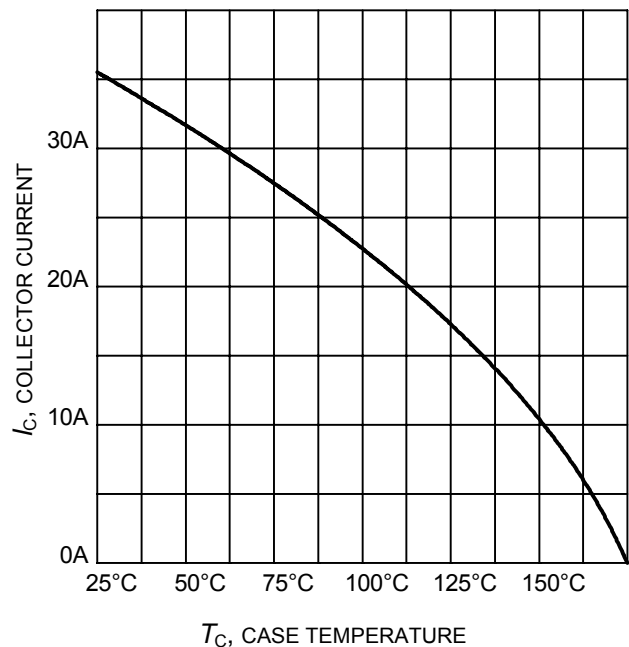
**Figure 1. Collector current as a function of switching frequency for hard switching (turn-off)**  
 ( $T_j \leq 175^\circ\text{C}$ ,  $D = 0.5$ ,  $V_{CE} = 600\text{V}$ ,  $V_{GE} = 0/+15\text{V}$ ,  $R_G = 14.8\Omega$ )



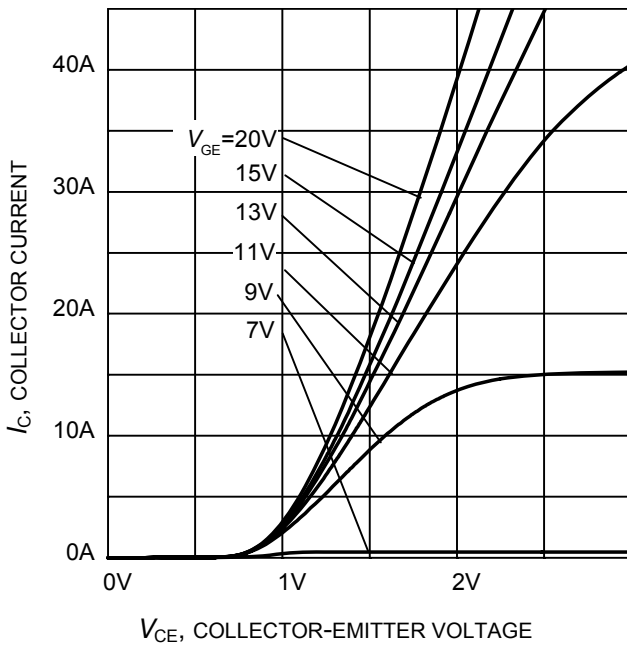
**Figure 2. IGBT Safe operating area**  
 ( $D = 0$ ,  $T_C = 25^\circ\text{C}$ ,  $T_j \leq 175^\circ\text{C}$ ;  $V_{GE} = 15\text{V}$ )



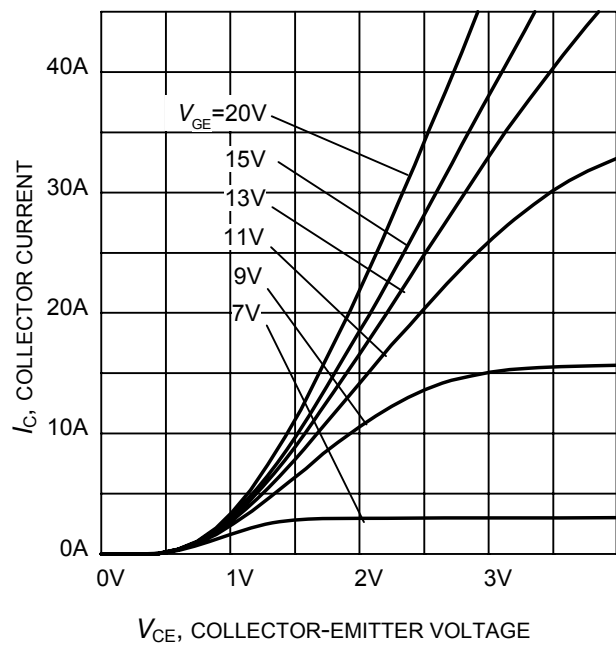
**Figure 3. Power dissipation as a function of case temperature**  
 ( $T_j \leq 175^\circ\text{C}$ )



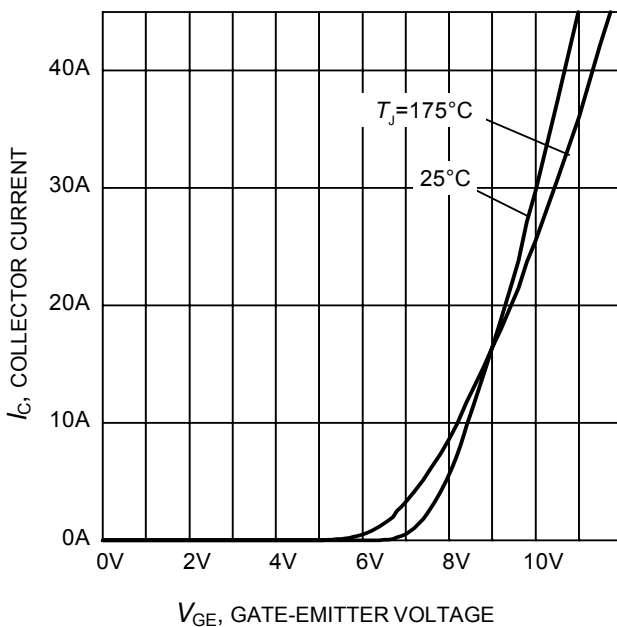
**Figure 4. DC Collector current as a function of case temperature**  
 ( $V_{GE} \geq 15\text{V}$ ,  $T_j \leq 175^\circ\text{C}$ )



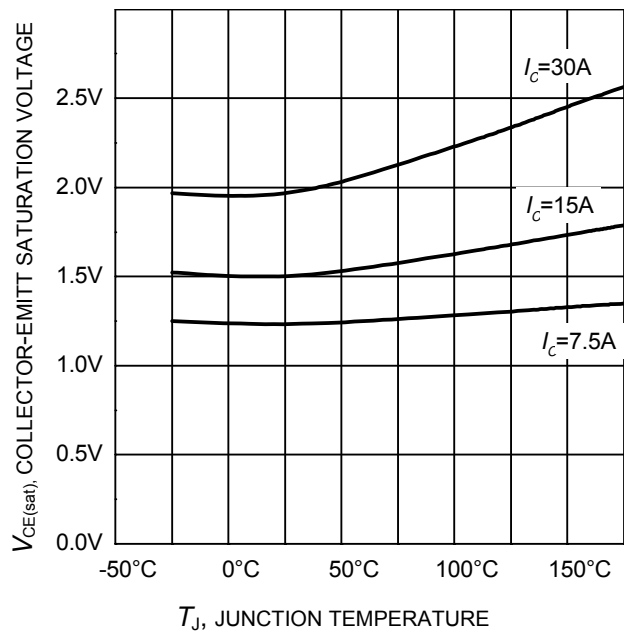
**Figure 5. Typical output characteristic**  
( $T_j = 25^\circ\text{C}$ )



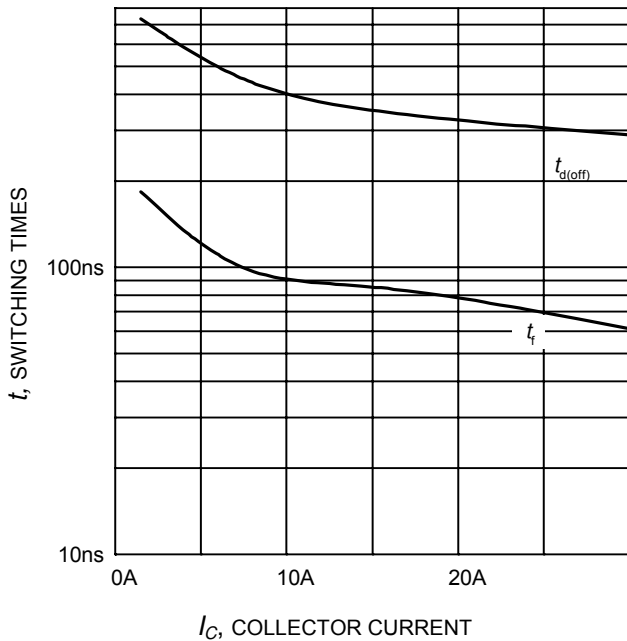
**Figure 6. Typical output characteristic**  
( $T_j = 175^\circ\text{C}$ )



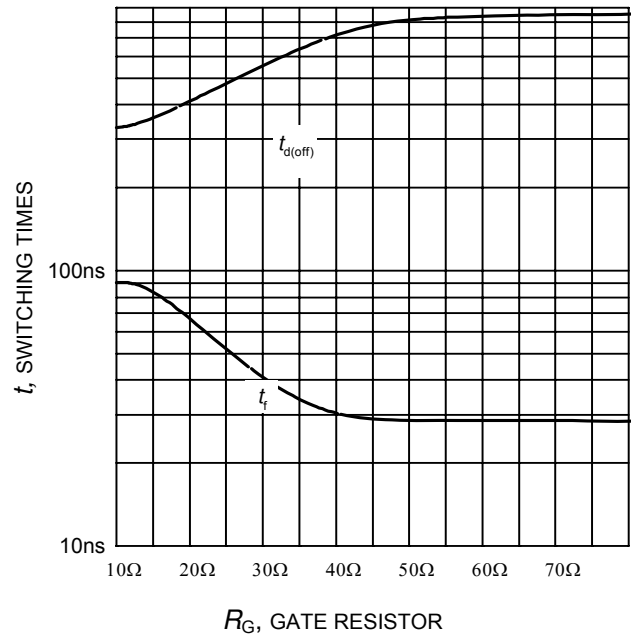
**Figure 7. Typical transfer characteristic**  
( $V_{CE} = 20\text{V}$ )



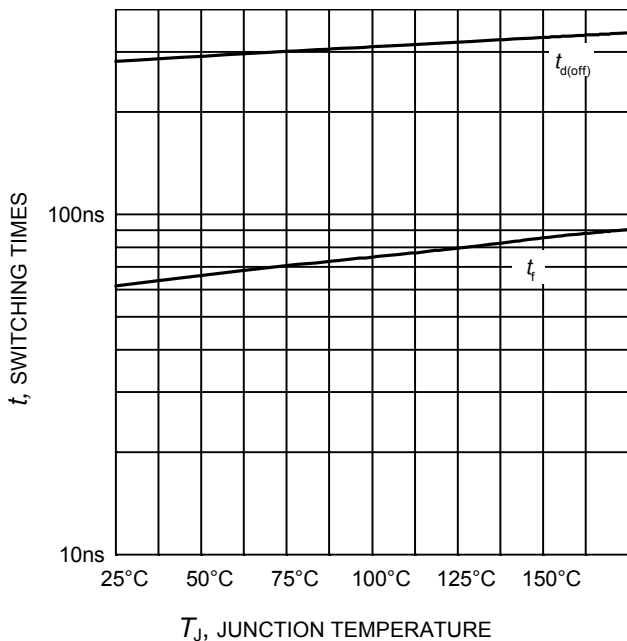
**Figure 8. Typical collector-emitter saturation voltage as a function of junction temperature**  
( $V_{GE} = 15\text{V}$ )



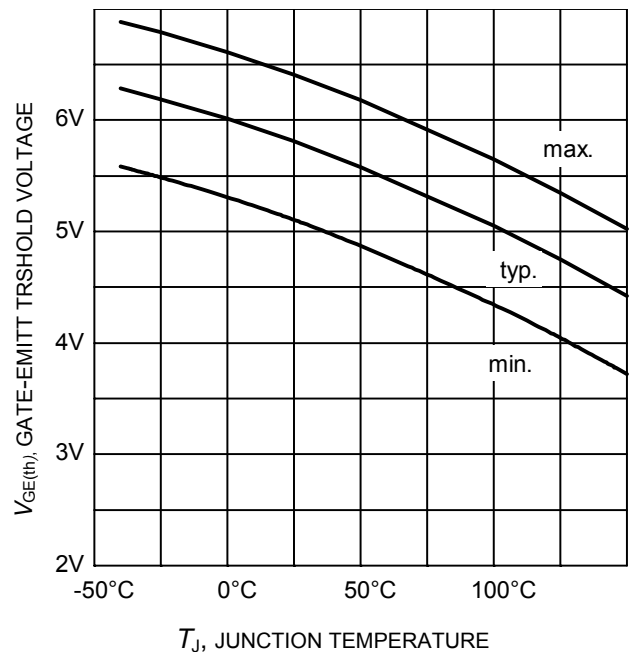
**Figure 9. Typical switching times as a function of collector current**  
 (inductive load,  $T_J=175^\circ\text{C}$ ,  $V_{CE}=600\text{V}$ ,  $V_{GE}=0/15\text{V}$ ,  $R_G=14.8\Omega$ , Dynamic test circuit in Figure E)



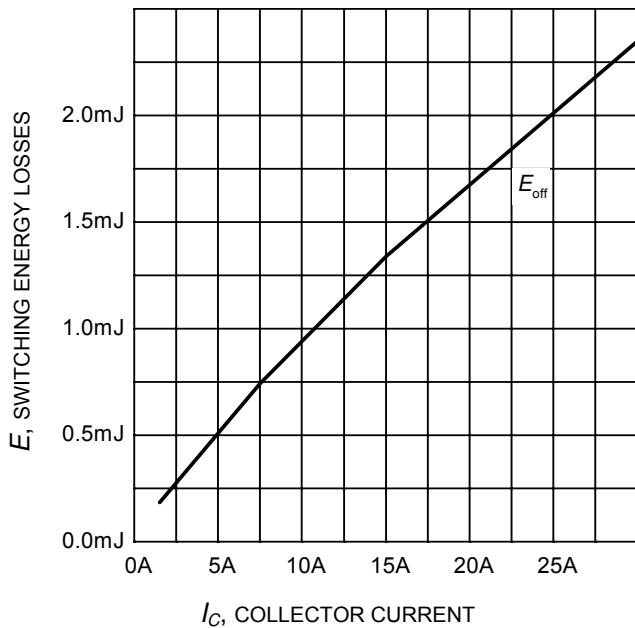
**Figure 10. Typical switching times as a function of gate resistor**  
 (inductive load,  $T_J=175^\circ\text{C}$ ,  $V_{CE}=600\text{V}$ ,  $V_{GE}=0/15\text{V}$ ,  $I_C=15\text{A}$ , Dynamic test circuit in Figure E)



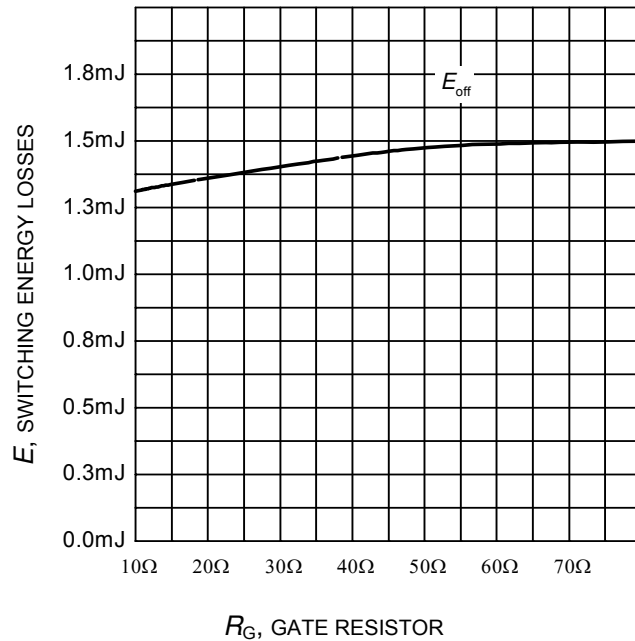
**Figure 11. Typical switching times as a function of junction temperature**  
 (inductive load,  $V_{CE}=600\text{V}$ ,  $V_{GE}=0/15\text{V}$ ,  $I_C=15\text{A}$ ,  $R_G=14.8\Omega$ , Dynamic test circuit in Figure E)



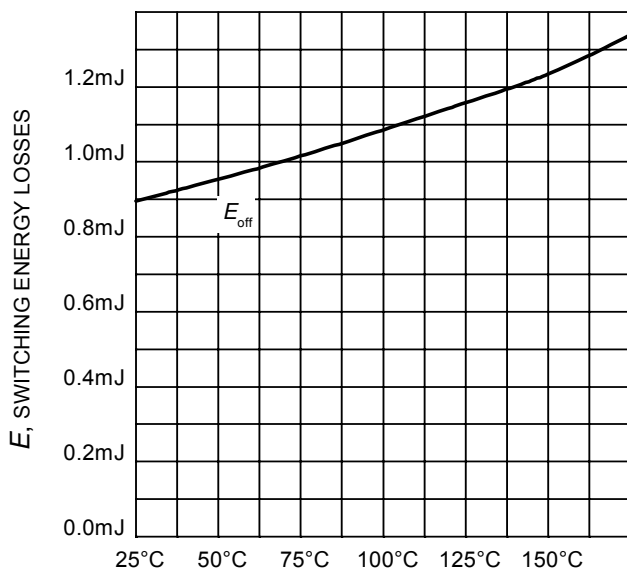
**Figure 12. Gate-emitter threshold voltage as a function of junction temperature**  
 ( $I_C = 0.4\text{mA}$ )



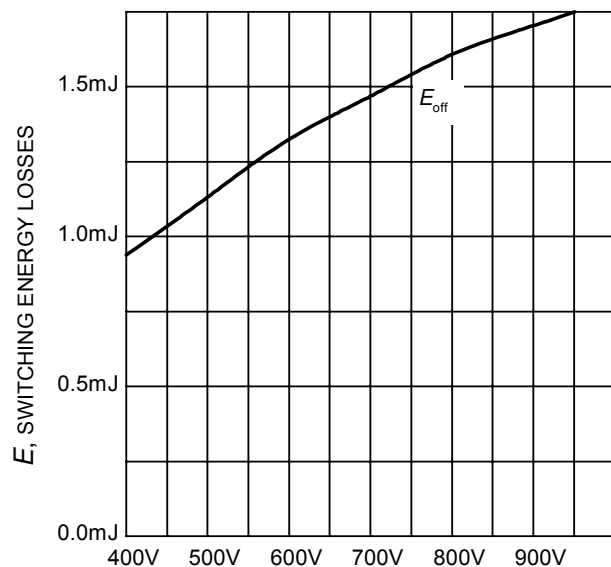
**Figure 13. Typical turn-off energy as a function of collector current**  
 (inductive load,  $T_J=175^\circ\text{C}$ ,  
 $V_{CE}=600\text{V}$ ,  $V_{GE}=0/15\text{V}$ ,  $R_G=14.8\Omega$ ,  
 Dynamic test circuit in Figure E)



**Figure 14. Typical turn-off energy as a function of gate resistor**  
 (inductive load,  $T_J=175^\circ\text{C}$ ,  
 $V_{CE}=600\text{V}$ ,  $V_{GE}=0/15\text{V}$ ,  $I_C=15\text{A}$ ,  
 Dynamic test circuit in Figure E)

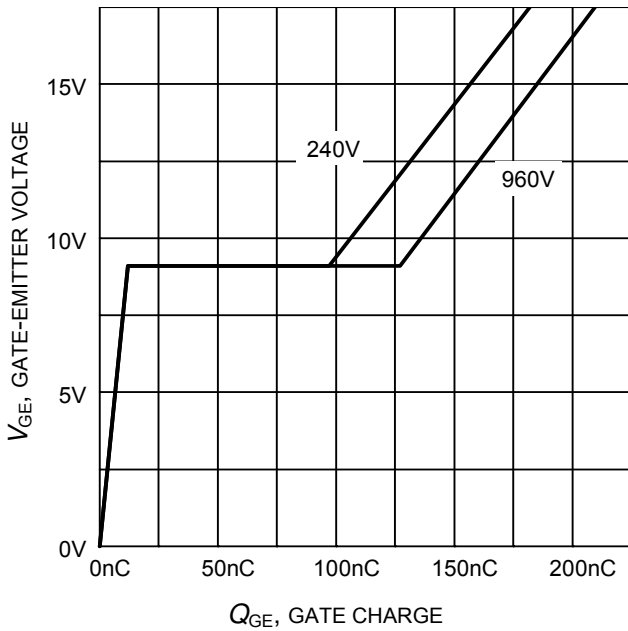


**Figure 15. Typical turn-off energy as a function of junction temperature**  
 (inductive load,  $V_{CE}=600\text{V}$ ,  
 $V_{GE}=0/15\text{V}$ ,  $I_C=15\text{A}$ ,  $R_G=14.8\Omega$ ,  
 Dynamic test circuit in Figure E)

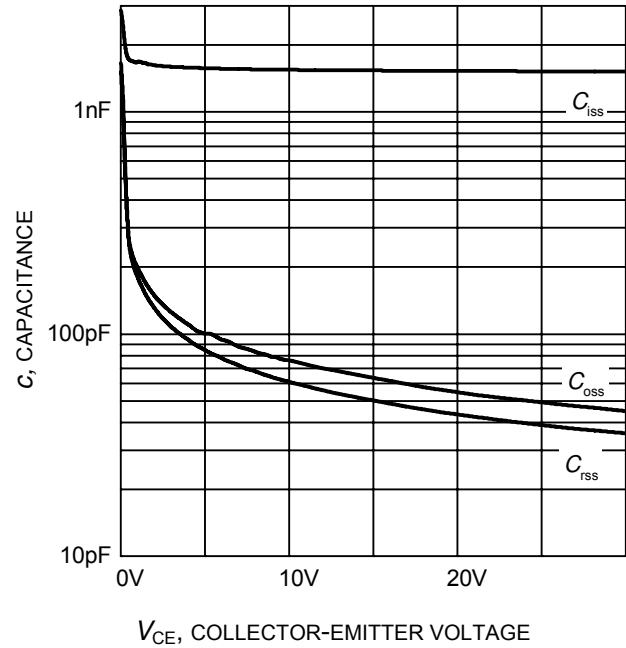


**Figure 16. Typical turn-off energy as a function of collector emitter voltage**  
 (inductive load,  $T_J=175^\circ\text{C}$ ,  
 $V_{GE}=0/15\text{V}$ ,  $I_C=15\text{A}$ ,  $R_G=14.8\Omega$ ,  
 Dynamic test circuit in Figure E)

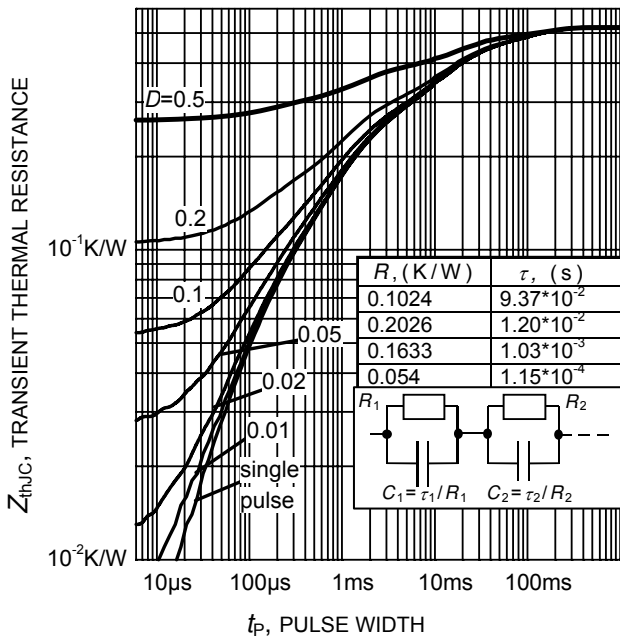




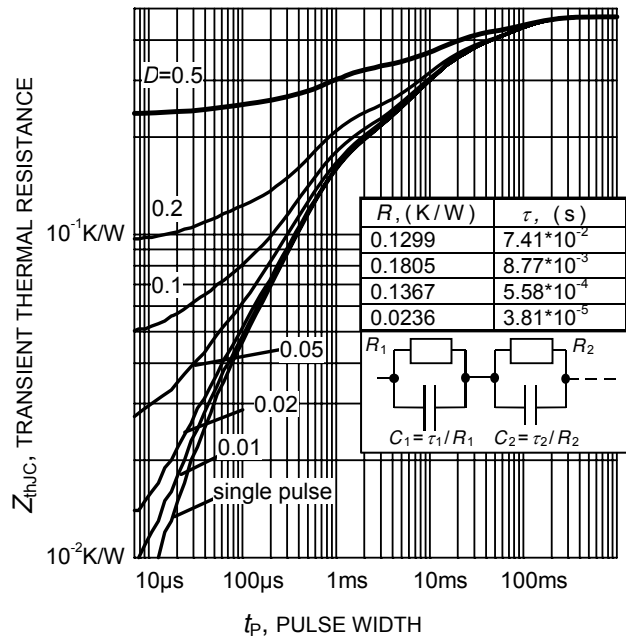
**Figure 17. Typical gate charge**  
( $I_C=15\text{ A}$ )



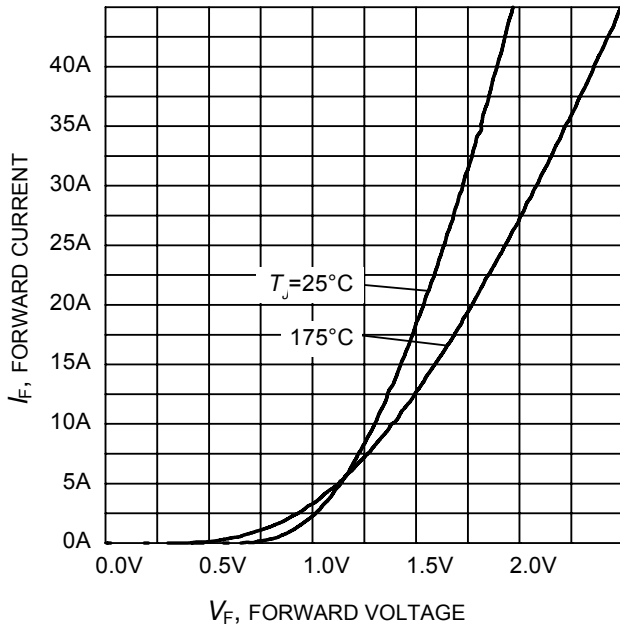
**Figure 18. Typical capacitance as a function of collector-emitter voltage**  
( $V_{GE}=0\text{V}$ ,  $f = 1\text{ MHz}$ )



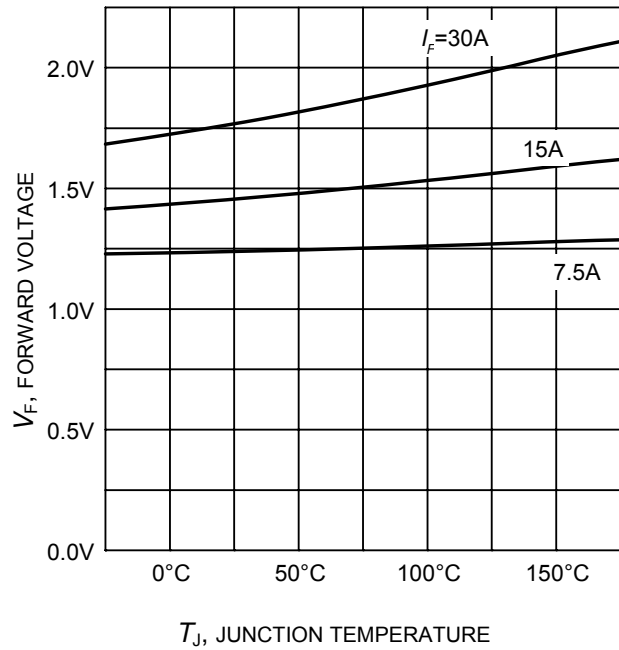
**Figure 19. IGBT transient thermal resistance**  
( $D = t_p / T$ )



**Figure 20. Typical Diode transient thermal impedance as a function of pulse width**  
( $D=t_p/T$ )

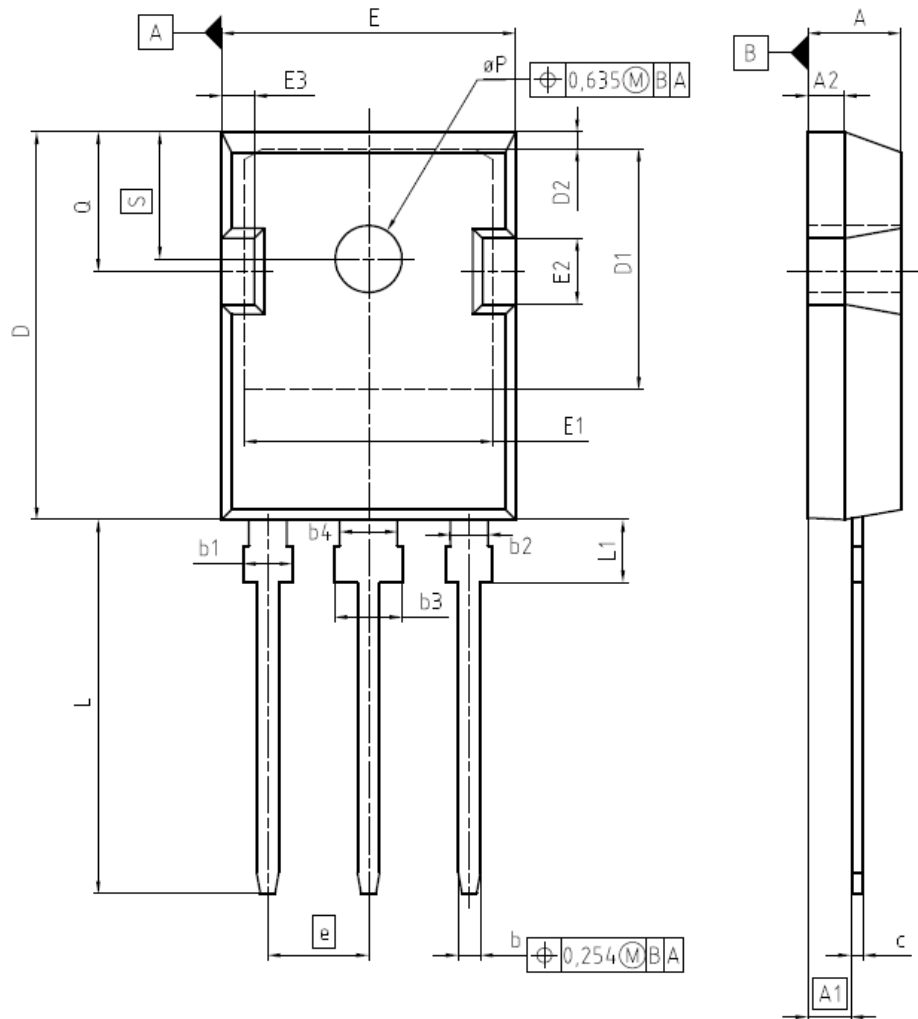


**Figure 21. Typical diode forward current as a function of forward voltage**



**Figure 22. Typical diode forward voltage as a function of junction temperature**

PG-TO247-3



DIM	MILLIMETERS		INCHES	
	MIN	MAX	MIN	MAX
A	4,90	5,16	0,193	0,203
A1	2,27	2,53	0,089	0,099
A2	1,85	2,11	0,073	0,083
b	1,07	1,33	0,042	0,052
b1	1,90	2,41	0,075	0,095
b2	1,90	2,16	0,075	0,085
b3	2,87	3,38	0,113	0,133
b4	2,87	3,13	0,113	0,123
c	0,55	0,68	0,022	0,027
D	20,82	21,10	0,820	0,831
D1	16,25	17,65	0,640	0,695
D2	1,05	1,35	0,041	0,053
E	15,70	16,03	0,618	0,631
E1	13,10	14,15	0,516	0,557
E2	3,68	5,10	0,145	0,201
E3	1,68	2,60	0,066	0,102
e	5,44		0,214	
N	3		3	
L	19,80	20,31	0,780	0,799
L1	4,17	4,47	0,164	0,176
øP	3,50	3,70	0,138	0,146
Q	5,49	6,00	0,216	0,236
S	6,04	6,30	0,238	0,248

<b>DOCUMENT NO.</b> Z8B00003327
<b>SCALE</b> 0 5 5 7,5mm
<b>EUROPEAN PROJECTION</b> 
<b>ISSUE DATE</b> 17-12-2007
<b>REVISION</b> 03

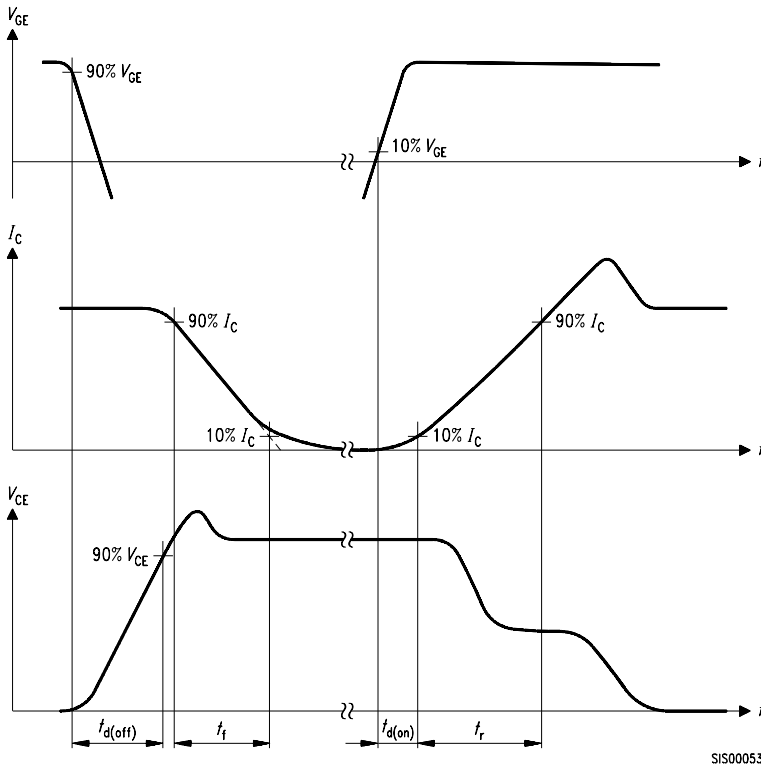


Figure A. Definition of switching times

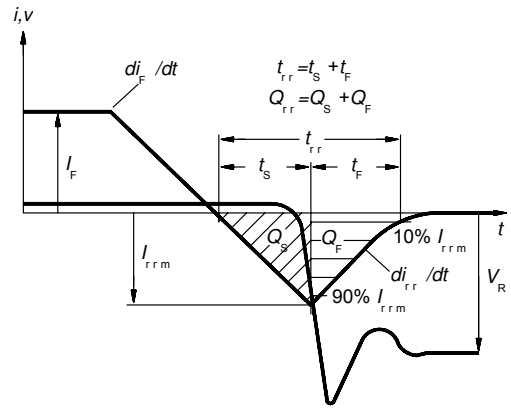


Figure C. Definition of diodes switching characteristics

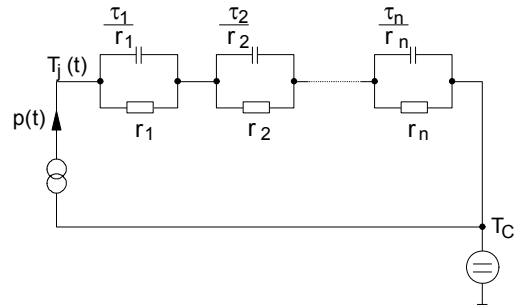


Figure D. Thermal equivalent circuit

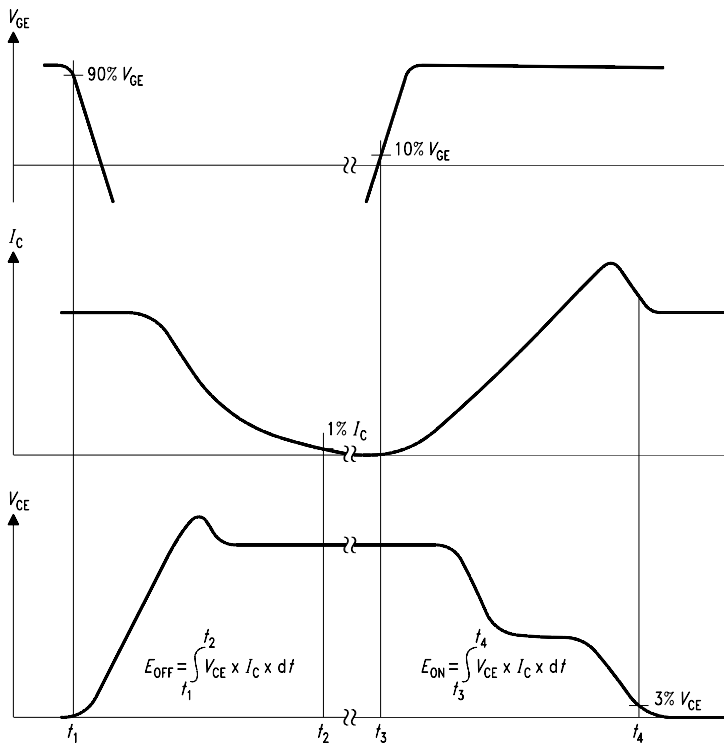


Figure B. Definition of switching losses

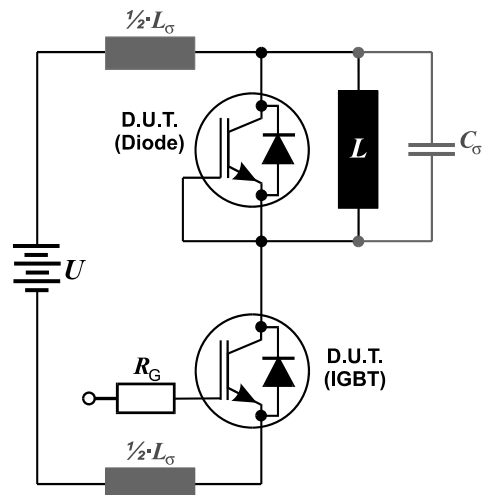


Figure E. Dynamic test circuit  
Leakage inductance  $L_{\sigma} = 180\text{nH}$   
and Stray capacity  $C_{\sigma} = 39\text{pF}$ .

**Edition 2006-01**

**Published by  
Infineon Technologies AG  
81726 München, Germany**

**© Infineon Technologies AG 2/14/08.  
All Rights Reserved.**

**Attention please!**

The information given in this data sheet shall in no event be regarded as a guarantee of conditions or characteristics ("Beschaffenheitsgarantie"). With respect to any examples or hints given herein, any typical values stated herein and/or any information regarding the application of the device, Infineon Technologies hereby disclaims any and all warranties and liabilities of any kind, including without limitation warranties of non-infringement of intellectual property rights of any third party.

**Information**

For further information on technology, delivery terms and conditions and prices please contact your nearest Infineon Technologies Office ([www.infineon.com](http://www.infineon.com)).

**Warnings**

Due to technical requirements components may contain dangerous substances. For information on the types in question please contact your nearest Infineon Technologies Office.

Infineon Technologies Components may only be used in life-support devices or systems with the express written approval of Infineon Technologies, if a failure of such components can reasonably be expected to cause the failure of that life-support device or system, or to affect the safety or effectiveness of that device or system. Life support devices or systems are intended to be implanted in the human body, or to support and/or maintain and sustain and/or protect human life. If they fail, it is reasonable to assume that the health of the user or other persons may be endangered.