



Chipsmall Limited consists of a professional team with an average of over 10 year of expertise in the distribution of electronic components. Based in Hongkong, we have already established firm and mutual-benefit business relationships with customers from,Europe,America and south Asia,supplying obsolete and hard-to-find components to meet their specific needs.

With the principle of "Quality Parts,Customers Priority,Honest Operation,and Considerate Service",our business mainly focus on the distribution of electronic components. Line cards we deal with include Microchip,ALPS,ROHM,Xilinx,Pulse,ON,Everlight and Freescale. Main products comprise IC,Modules,Potentiometer,IC Socket,Relay,Connector.Our parts cover such applications as commercial,industrial, and automotives areas.

We are looking forward to setting up business relationship with you and hope to provide you with the best service and solution. Let us make a better world for our industry!



## Contact us

Tel: +86-755-8981 8866 Fax: +86-755-8427 6832

Email & Skype: info@chipsmall.com Web: www.chipsmall.com

Address: A1208, Overseas Decoration Building, #122 Zhenhua RD., Futian, Shenzhen, China



High speed switching series 5<sup>th</sup> generation

## TRENCHSTOP™ 5 high speed switching IGBT copacked with full rated current RAPID 1 anti parallel diode

### Features and Benefits:

- High speed H5 technology offering
- Best-in-Class efficiency in hard switching and resonant topologies
  - 650V breakdown voltage
  - Low  $Q_G$
  - IGBT copacked with full rated current RAPID 1 fast antiparallel diode
  - Maximum junction temperature 175°C
  - Pb-free lead plating; RoHS compliant
  - Complete product spectrum and PSpice Models:  
<http://www.infineon.com/igbt/>

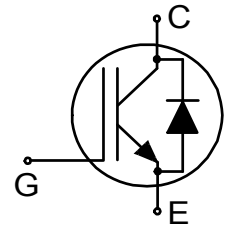

### Potential Applications:

- Energy Generation
  - Solar String Inverter
  - Solar Micro Inverter
- Industrial Power Supplies
  - Industrial SMPS
  - Industrial UPS
- Metal Treatment
  - Welding
- Energy Distribution
  - Energy Storage
- Infrastructure – Charge
  - Charger

### Product Validation:

Qualified for industrial applications according to the relevant tests of JEDEC47/20/22



### Key Performance and Package Parameters

| Type        | $V_{CE}$ | $I_C$ | $V_{CEsat}, T_{vj}=25^{\circ}C$ | $T_{vjmax}$ | Marking | Package    |
|-------------|----------|-------|---------------------------------|-------------|---------|------------|
| IKB40N65EH5 | 650V     | 40A   | 1.65V                           | 175°C       | K40EEH5 | PG-TO263-3 |

## Table of Contents

|   |    |
|---|----|
| Description .....                         | 1  |
| Table of Contents .....                   | 2  |
| Maximum Ratings .....                     | 3  |
| Thermal Resistance .....                  | 3  |
| Electrical Characteristics .....          | 4  |
| Electrical Characteristics Diagrams ..... | 7  |
| Package Drawing .....                     | 13 |
| Testing Conditions .....                  | 14 |
| Revision History .....                    | 15 |
| Disclaimer .....                          | 16 |

## High speed switching series 5<sup>th</sup> generation

### Maximum Ratings

For optimum lifetime and reliability, Infineon recommends operating conditions that do not exceed 80% of the maximum ratings stated in this datasheet.

| Parameter  | Symbol      | Value                | Unit               |
|--|-------------|----------------------|--------------------|
| Collector-emitter voltage, $T_{vj} \geq 25^{\circ}\text{C}$  | $V_{CE}$    | 650                  | V                  |
| DC collector current, limited by $T_{vjmax}$<br>$T_c = 25^{\circ}\text{C}$<br>$T_c = 100^{\circ}\text{C}$                | $I_C$       | 74.0<br>46.0         | A                  |
| Pulsed collector current, $t_p$ limited by $T_{vjmax}$   | $I_{Cpuls}$ | 160.0                | A                  |
| Turn off safe operating area<br>$V_{CE} \leq 650\text{V}$ , $T_{vj} \leq 175^{\circ}\text{C}$ , $t_p = 1\mu\text{s}$     | -           | 160.0                | A                  |
| Diode forward current, limited by $T_{vjmax}$ <sup>1)</sup><br>$T_c = 25^{\circ}\text{C}$<br>$T_c = 100^{\circ}\text{C}$ | $I_F$       | 40.0<br>40.0         | A                  |
| Diode pulsed current, $t_p$ limited by $T_{vjmax}$   | $I_{Fpuls}$ | 160.0                | A                  |
| Gate-emitter voltage<br>Transient Gate-emitter voltage ( $t_p \leq 10\mu\text{s}$ , $D < 0.010$ )                        | $V_{GE}$    | $\pm 20$<br>$\pm 30$ | V                  |
| Power dissipation $T_c = 25^{\circ}\text{C}$<br>Power dissipation $T_c = 100^{\circ}\text{C}$                            | $P_{tot}$   | 250.0<br>125.0       | W                  |
| Operating junction temperature   | $T_{vj}$    | -40...+175           | $^{\circ}\text{C}$ |
| Storage temperature  | $T_{stg}$   | -55...+150           | $^{\circ}\text{C}$ |
| Soldering temperature,<br>reflow soldering (MSL1 according to JEDEC J-STA-020)   |             | 260                  | $^{\circ}\text{C}$ |

### Thermal Resistance

| Parameter   | Symbol        | Conditions | Value |      |      | Unit |
|---|---------------|------------|-------|------|------|------|
|   |               |            | min.  | typ. | max. |      |
| <b>R<sub>th</sub> Characteristics</b>                                   |               |            |       |      |      |      |
| IGBT thermal resistance,<br>junction - case                             | $R_{th(j-c)}$ |            | -     | -    | 0.60 | K/W  |
| Diode thermal resistance,<br>junction - case                            | $R_{th(j-c)}$ |            | -     | -    | 0.75 | K/W  |
| Thermal resistance, min. footprint<br>junction - ambient                | $R_{th(j-a)}$ |            | -     | -    | 65   | K/W  |
| Thermal resistance, 6cm <sup>2</sup> Cu on<br>PCB<br>junction - ambient | $R_{th(j-a)}$ |            | -     | -    | 40   | K/W  |

<sup>1)</sup> value limited by bondwire

## High speed switching series 5<sup>th</sup> generation

### Electrical Characteristic, at $T_{vj} = 25^{\circ}\text{C}$ , unless otherwise specified

| Parameter                            | Symbol        | Conditions   | Value |      |      | Unit          |
|--------------------------------------|---------------|--|-------|------|------|---------------|
|                                      |               |  | min.  | typ. | max. |               |
| <b>Static Characteristic</b>         |               |  |       |      |      |               |
| Collector-emitter breakdown voltage  | $V_{(BR)CES}$ | $V_{GE} = 0\text{V}, I_C = 0.20\text{mA}$  | 650   | -    | -    | V             |
| Collector-emitter saturation voltage | $V_{CESat}$   | $V_{GE} = 15.0\text{V}, I_C = 40.0\text{A}$<br>$T_{vj} = 25^{\circ}\text{C}$<br>$T_{vj} = 125^{\circ}\text{C}$<br>$T_{vj} = 175^{\circ}\text{C}$ | -     | 1.65 | 2.10 | V             |
|                                      |               |  | -     | 1.85 | -    |               |
|                                      |               |  | -     | 1.95 | -    |               |
| Diode forward voltage                | $V_F$         | $V_{GE} = 0\text{V}, I_F = 40.0\text{A}$<br>$T_{vj} = 25^{\circ}\text{C}$<br>$T_{vj} = 125^{\circ}\text{C}$<br>$T_{vj} = 175^{\circ}\text{C}$    | -     | 1.45 | 1.70 | V             |
|                                      |               |  | -     | 1.42 | -    |               |
|                                      |               |  | -     | 1.39 | -    |               |
| Gate-emitter threshold voltage       | $V_{GE(th)}$  | $I_C = 0.40\text{mA}, V_{CE} = V_{GE}$   | 3.2   | 4.0  | 4.8  | V             |
| Zero gate voltage collector current  | $I_{CES}$     | $V_{CE} = 650\text{V}, V_{GE} = 0\text{V}$<br>$T_{vj} = 25^{\circ}\text{C}$<br>$T_{vj} = 175^{\circ}\text{C}$                                    | -     | -    | 50   | $\mu\text{A}$ |
|                                      |               |  | -     | 2000 | -    |               |
| Gate-emitter leakage current         | $I_{GES}$     | $V_{CE} = 0\text{V}, V_{GE} = 20\text{V}$  | -     | -    | 100  | nA            |
| Transconductance                     | $g_{fs}$      | $V_{CE} = 20\text{V}, I_C = 40.0\text{A}$  | -     | 50.0 | -    | S             |

### Electrical Characteristic, at $T_{vj} = 25^{\circ}\text{C}$ , unless otherwise specified

| Parameter  | Symbol    | Conditions   | Value |      |      | Unit |
|--|-----------|--|-------|------|------|------|
|  |           |  | min.  | typ. | max. |      |
| <b>Dynamic Characteristic</b>                                  |           |  |       |      |      |      |
| Input capacitance  | $C_{ies}$ | $V_{CE} = 25\text{V}, V_{GE} = 0\text{V}, f = 1\text{MHz}$           | -     | 2500 | -    | pF   |
| Output capacitance   | $C_{oes}$ |  | -     | 71   | -    |      |
| Reverse transfer capacitance                                   | $C_{res}$ |  | -     | 9    | -    |      |
| Gate charge  | $Q_G$     | $V_{CC} = 520\text{V}, I_C = 40.0\text{A},$<br>$V_{GE} = 15\text{V}$ | -     | 95.0 | -    | nC   |
| Internal emitter inductance measured 5mm (0.197 in.) from case | $L_E$     |  | -     | 7.0  | -    | nH   |

### Switching Characteristic, Inductive Load

| Parameter | Symbol | Conditions | Value |      |      | Unit |
|-----------|--------|------------|-------|------|------|------|
|           |        |            | min.  | typ. | max. |      |

### IGBT Characteristic, at $T_{vj} = 25^{\circ}\text{C}$

|                        |              |   |   |      |   |    |
|------------------------|--------------|---|---|------|---|----|
| Turn-on delay time     | $t_{d(on)}$  | $T_{vj} = 25^{\circ}\text{C},$<br>$V_{CC} = 400\text{V}, I_C = 40.0\text{A},$<br>$V_{GE} = 0.0/15.0\text{V},$<br>$R_{G(on)} = 15.0\Omega, R_{G(off)} = 15.0\Omega,$<br>$L_{\sigma} = 30\text{nH}, C_{\sigma} = 31\text{pF}$<br>$L_{\sigma}, C_{\sigma}$ from Fig. E<br>Energy losses include "tail" and diode reverse recovery. | - | 20   | - | ns |
| Rise time              | $t_r$        |   | - | 30   | - | ns |
| Turn-off delay time    | $t_{d(off)}$ |   | - | 157  | - | ns |
| Fall time              | $t_f$        |   | - | 30   | - | ns |
| Turn-on energy         | $E_{on}$     |   | - | 1.10 | - | mJ |
| Turn-off energy        | $E_{off}$    |   | - | 0.40 | - | mJ |
| Total switching energy | $E_{ts}$     |   | - | 1.50 | - | mJ |

High speed switching series 5<sup>th</sup> generation

|                        |              |   |   |      |   |    |
|------------------------|--------------|---|---|------|---|----|
| Turn-on delay time     | $t_{d(on)}$  | $T_{vj} = 25^{\circ}C,$<br>$V_{CC} = 400V, I_C = 20.0A,$<br>$V_{GE} = 0.0/15.0V,$<br>$R_{G(on)} = 15.0\Omega, R_{G(off)} = 15.0\Omega,$<br>$L\sigma = 30nH, C\sigma = 31pF$<br>$L\sigma, C\sigma$ from Fig. E<br>Energy losses include "tail" and diode reverse recovery. | - | 18   | - | ns |
| Rise time              | $t_r$        |   | - | 16   | - | ns |
| Turn-off delay time    | $t_{d(off)}$ |   | - | 160  | - | ns |
| Fall time              | $t_f$        |   | - | 30   | - | ns |
| Turn-on energy         | $E_{on}$     |   | - | 0.38 | - | mJ |
| Turn-off energy        | $E_{off}$    |   | - | 0.11 | - | mJ |
| Total switching energy | $E_{ts}$     |   | - | 0.49 | - | mJ |

**Diode Characteristic, at  $T_{vj} = 25^{\circ}C$**

|  |              |   |   |       |   |           |
|--|--------------|---|---|-------|---|-----------|
| Diode reverse recovery time                                      | $t_{rr}$     | $T_{vj} = 25^{\circ}C,$<br>$V_R = 400V,$<br>$I_F = 40.0A,$<br>$di_F/dt = 1400A/\mu s$ | - | 78    | - | ns        |
| Diode reverse recovery charge                                    | $Q_{rr}$     |   | - | 1.00  | - | $\mu C$   |
| Diode peak reverse recovery current                              | $I_{rrm}$    |   | - | 16.5  | - | A         |
| Diode peak rate of fall of reverse recovery current during $t_b$ | $di_{rr}/dt$ |   | - | -1500 | - | $A/\mu s$ |

|  |              |   |   |       |   |           |
|--|--------------|---|---|-------|---|-----------|
| Diode reverse recovery time                                      | $t_{rr}$     | $T_{vj} = 25^{\circ}C,$<br>$V_R = 400V,$<br>$I_F = 20.0A,$<br>$di_F/dt = 1400A/\mu s$ | - | 56    | - | ns        |
| Diode reverse recovery charge                                    | $Q_{rr}$     |   | - | 0.67  | - | $\mu C$   |
| Diode peak reverse recovery current                              | $I_{rrm}$    |   | - | 16.2  | - | A         |
| Diode peak rate of fall of reverse recovery current during $t_b$ | $di_{rr}/dt$ |   | - | -1324 | - | $A/\mu s$ |

**Switching Characteristic, Inductive Load**

| Parameter | Symbol | Conditions | Value |      |      | Unit |
|-----------|--------|------------|-------|------|------|------|
|           |        |            | min.  | typ. | max. |      |

**IGBT Characteristic, at  $T_{vj} = 150^{\circ}C$**

|                        |              |  |   |      |   |    |
|------------------------|--------------|--|---|------|---|----|
| Turn-on delay time     | $t_{d(on)}$  | $T_{vj} = 150^{\circ}C,$<br>$V_{CC} = 400V, I_C = 40.0A,$<br>$V_{GE} = 0.0/15.0V,$<br>$R_{G(on)} = 15.0\Omega, R_{G(off)} = 15.0\Omega,$<br>$L\sigma = 30nH, C\sigma = 31pF$<br>$L\sigma, C\sigma$ from Fig. E<br>Energy losses include "tail" and diode reverse recovery. | - | 20   | - | ns |
| Rise time              | $t_r$        |  | - | 28   | - | ns |
| Turn-off delay time    | $t_{d(off)}$ |  | - | 175  | - | ns |
| Fall time              | $t_f$        |  | - | 30   | - | ns |
| Turn-on energy         | $E_{on}$     |  | - | 1.40 | - | mJ |
| Turn-off energy        | $E_{off}$    |  | - | 0.42 | - | mJ |
| Total switching energy | $E_{ts}$     |  | - | 1.82 | - | mJ |

|                        |              |  |   |      |   |    |
|------------------------|--------------|--|---|------|---|----|
| Turn-on delay time     | $t_{d(on)}$  | $T_{vj} = 150^{\circ}C,$<br>$V_{CC} = 400V, I_C = 20.0A,$<br>$V_{GE} = 0.0/15.0V,$<br>$R_{G(on)} = 15.0\Omega, R_{G(off)} = 15.0\Omega,$<br>$L\sigma = 30nH, C\sigma = 31pF$<br>$L\sigma, C\sigma$ from Fig. E<br>Energy losses include "tail" and diode reverse recovery. | - | 17   | - | ns |
| Rise time              | $t_r$        |  | - | 16   | - | ns |
| Turn-off delay time    | $t_{d(off)}$ |  | - | 180  | - | ns |
| Fall time              | $t_f$        |  | - | 26   | - | ns |
| Turn-on energy         | $E_{on}$     |  | - | 0.64 | - | mJ |
| Turn-off energy        | $E_{off}$    |  | - | 0.12 | - | mJ |
| Total switching energy | $E_{ts}$     |  | - | 0.76 | - | mJ |

High speed switching series 5<sup>th</sup> generation

**Diode Characteristic, at  $T_{vj} = 150^{\circ}\text{C}$**

|  |              |  |   |       |   |                        |
|--|--------------|--|---|-------|---|------------------------|
| Diode reverse recovery time                                      | $t_{rr}$     | $T_{vj} = 150^{\circ}\text{C},$<br>$V_R = 400\text{V},$<br>$I_F = 40.0\text{A},$<br>$di_F/dt = 1400\text{A}/\mu\text{s}$ | - | 105   | - | ns                     |
| Diode reverse recovery charge                                    | $Q_{rr}$     |  | - | 2.15  | - | $\mu\text{C}$          |
| Diode peak reverse recovery current                              | $I_{rrm}$    |  | - | 28.0  | - | A                      |
| Diode peak rate of fall of reverse recovery current during $t_b$ | $di_{rr}/dt$ |  | - | -1950 | - | $\text{A}/\mu\text{s}$ |
| Diode reverse recovery time                                      | $t_{rr}$     | $T_{vj} = 150^{\circ}\text{C},$<br>$V_R = 400\text{V},$<br>$I_F = 20.0\text{A},$<br>$di_F/dt = 1400\text{A}/\mu\text{s}$ | - | 85    | - | ns                     |
| Diode reverse recovery charge                                    | $Q_{rr}$     |  | - | 1.50  | - | $\mu\text{C}$          |
| Diode peak reverse recovery current                              | $I_{rrm}$    |  | - | 24.0  | - | A                      |
| Diode peak rate of fall of reverse recovery current during $t_b$ | $di_{rr}/dt$ |  | - | -1830 | - | $\text{A}/\mu\text{s}$ |

High speed switching series 5<sup>th</sup> generation

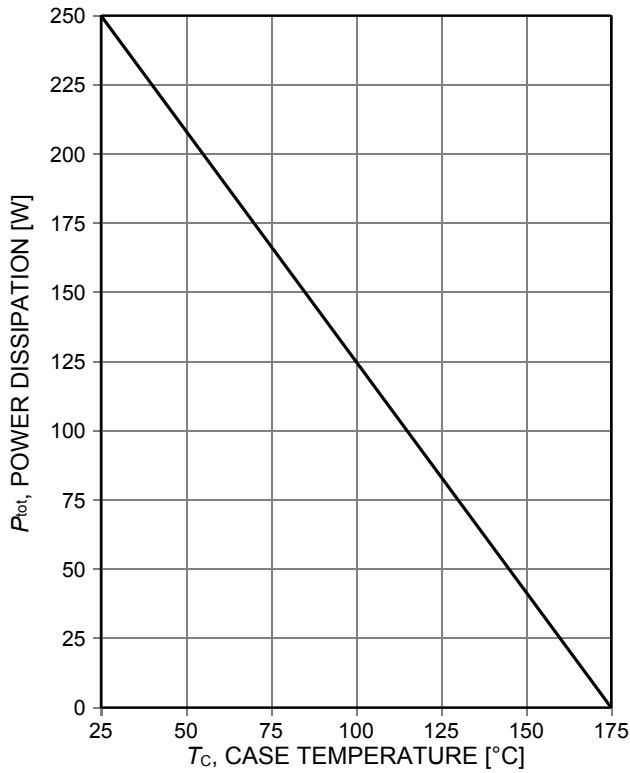

Figure 1. Power dissipation as a function of case temperature ( $T_{vj} \leq 175^\circ\text{C}$ )

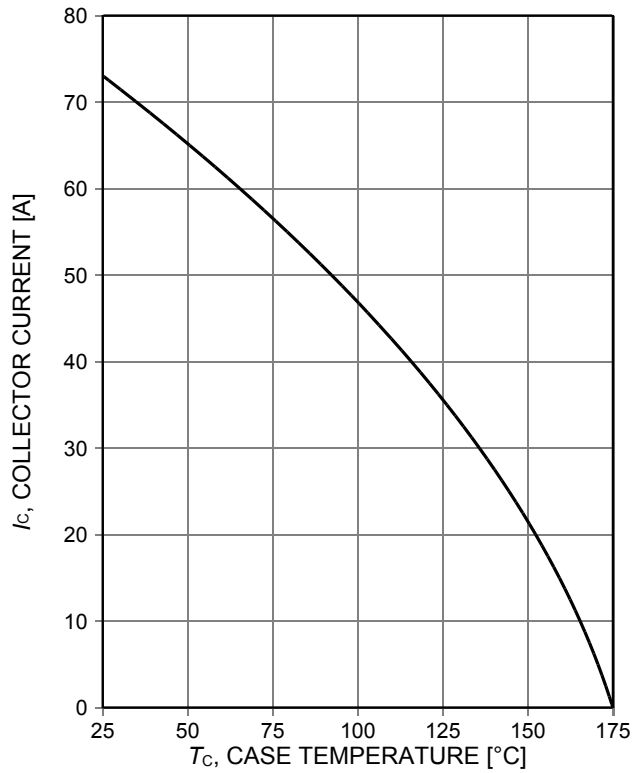

Figure 2. Collector current as a function of case temperature ( $V_{GE} \geq 15\text{V}$ ,  $T_{vj} \leq 175^\circ\text{C}$ )

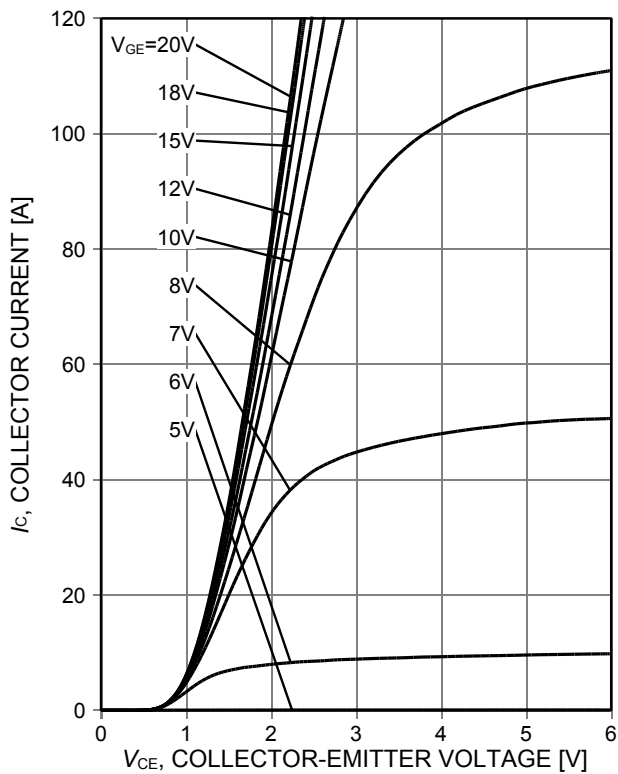

Figure 3. Typical output characteristic ( $T_{vj} = 25^\circ\text{C}$ )

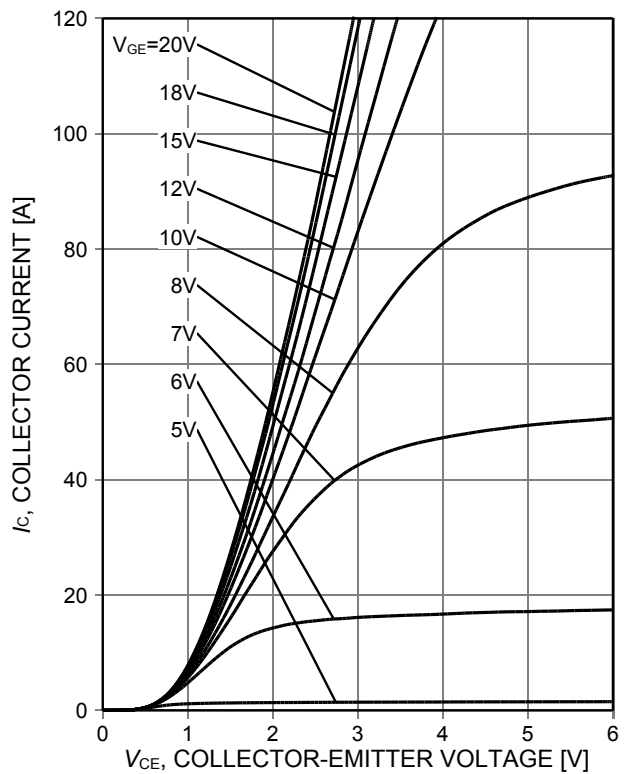

Figure 4. Typical output characteristic ( $T_{vj} = 150^\circ\text{C}$ )



High speed switching series 5<sup>th</sup> generation

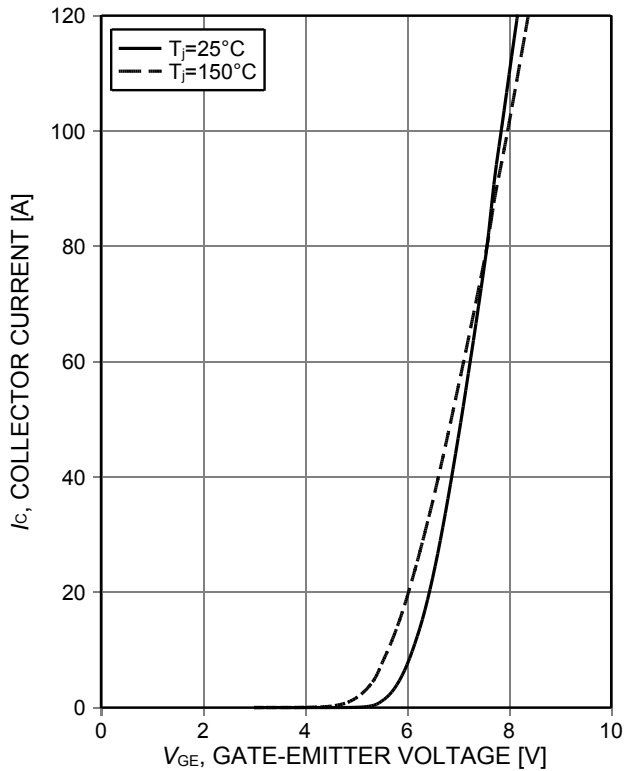

Figure 5. Typical transfer characteristic ( $V_{CE}=20\text{V}$ )

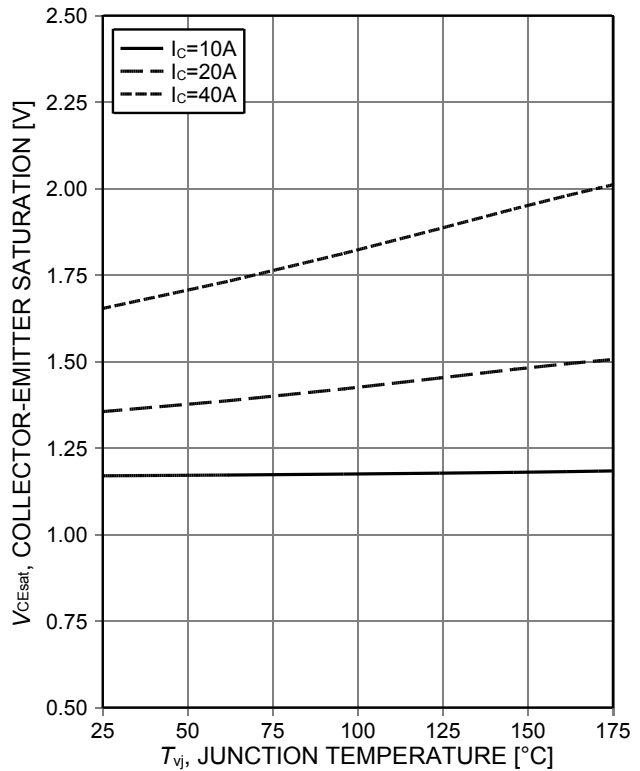

Figure 6. Typical collector-emitter saturation voltage as a function of junction temperature ( $V_{GE}=15\text{V}$ )

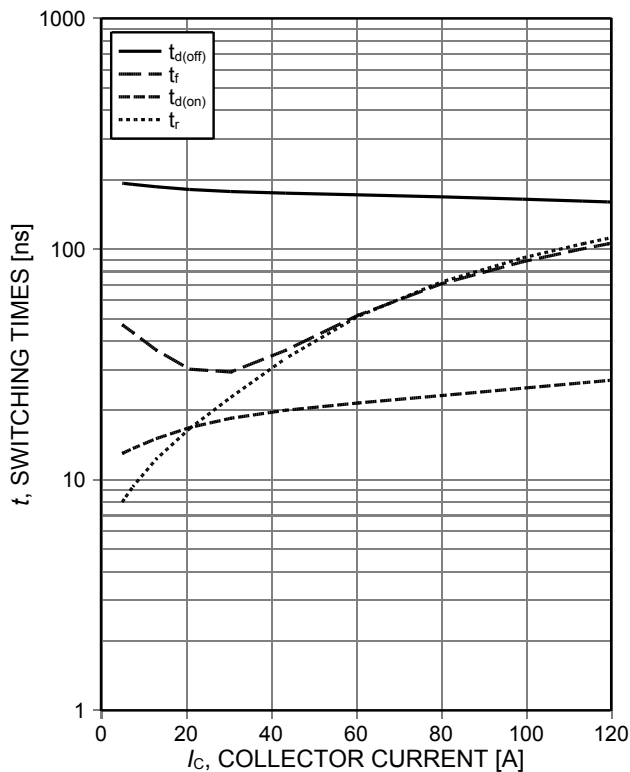

Figure 7. Typical switching times as a function of collector current (inductive load,  $T_{vj}=150^\circ\text{C}$ ,  $V_{CE}=400\text{V}$ ,  $V_{GE}=15/0\text{V}$ ,  $R_G=15\Omega$ , Dynamic test circuit in Figure E)

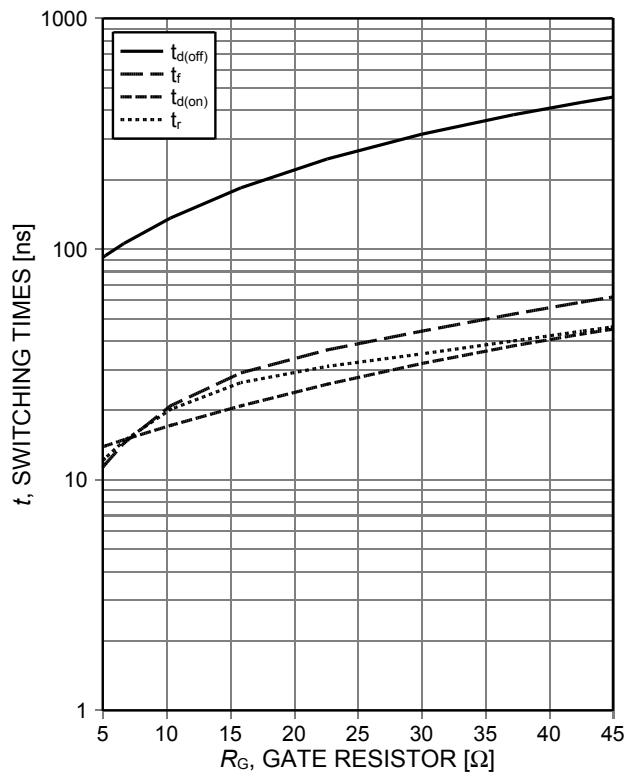

Figure 8. Typical switching times as a function of gate resistor (inductive load,  $T_{vj}=150^\circ\text{C}$ ,  $V_{CE}=400\text{V}$ ,  $V_{GE}=15/0\text{V}$ ,  $I_c=40\text{A}$ , Dynamic test circuit in Figure E)

High speed switching series 5<sup>th</sup> generation

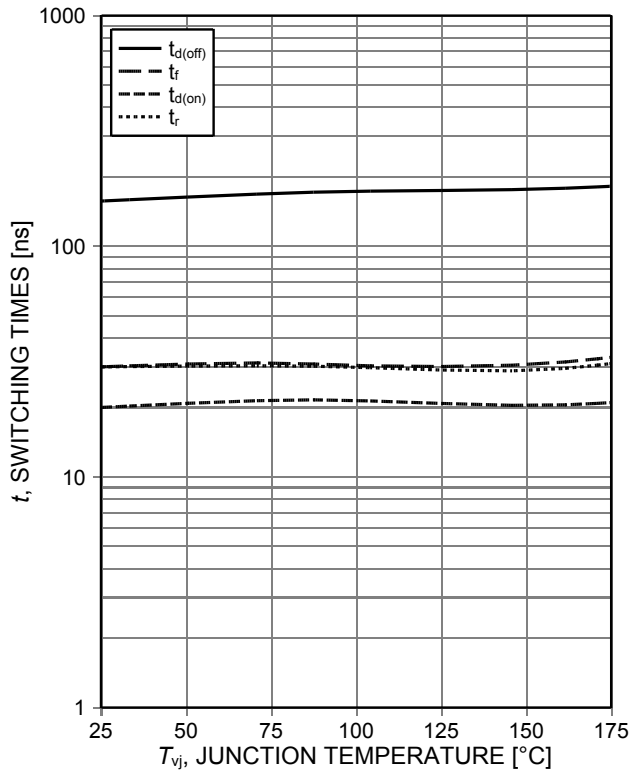

Figure 9. **Typical switching times as a function of junction temperature**  
 (inductive load,  $V_{CE}=400V$ ,  $V_{GE}=15/0V$ ,  $I_C=40A$ ,  $R_G=15\Omega$ , Dynamic test circuit in Figure E)

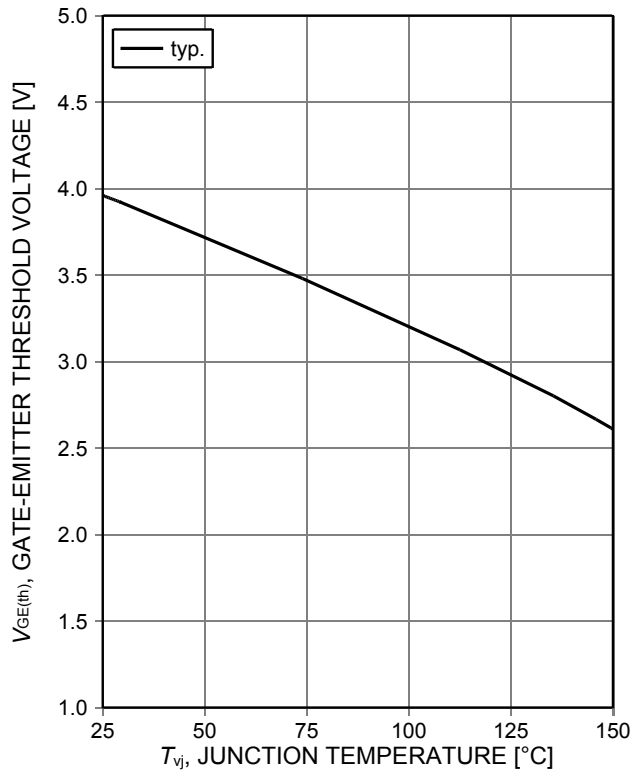

Figure 10. **Gate-emitter threshold voltage as a function of junction temperature**  
 ( $I_C=0.4mA$ )

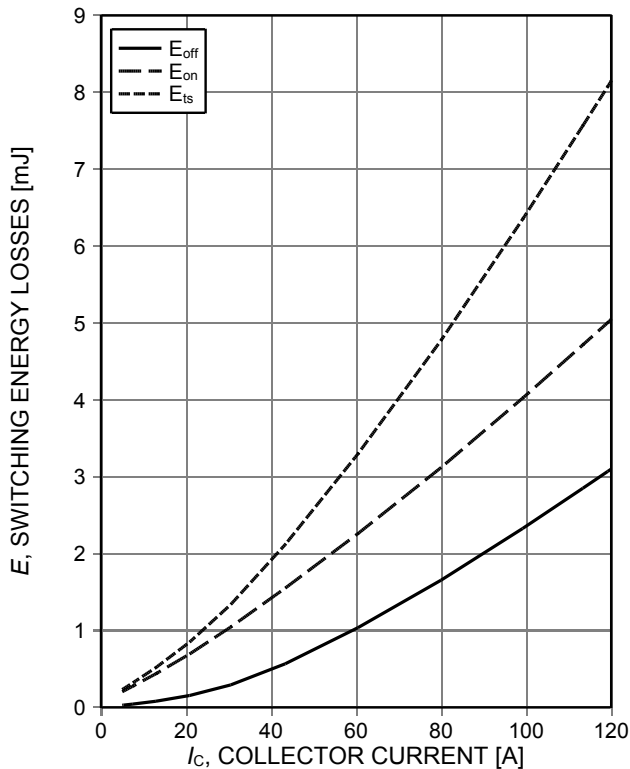

Figure 11. **Typical switching energy losses as a function of collector current**  
 (inductive load,  $T_{vj}=150^\circ C$ ,  $V_{CE}=400V$ ,  $V_{GE}=15/0V$ ,  $R_G=15\Omega$ , Dynamic test circuit in Figure E)

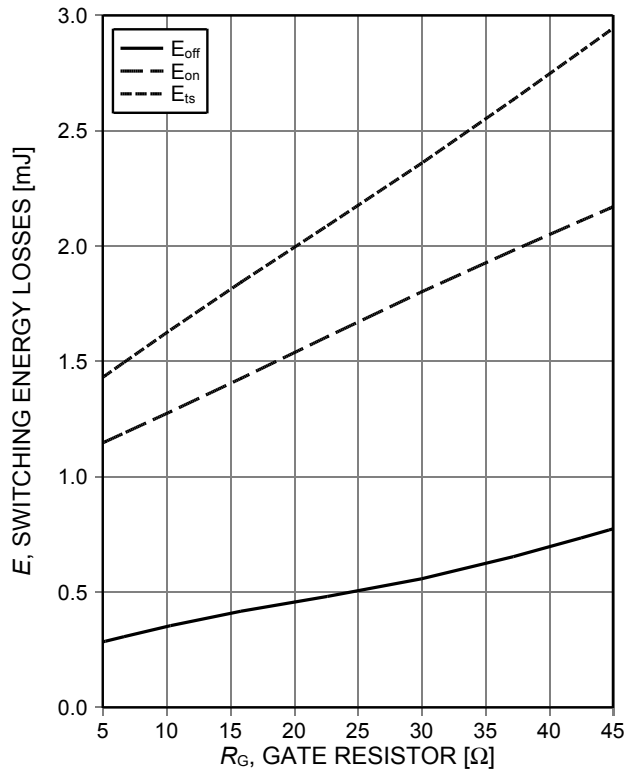

Figure 12. **Typical switching energy losses as a function of gate resistor**  
 (inductive load,  $T_{vj}=150^\circ C$ ,  $V_{CE}=400V$ ,  $V_{GE}=15/0V$ ,  $I_C=40A$ , Dynamic test circuit in Figure E)

High speed switching series 5<sup>th</sup> generation

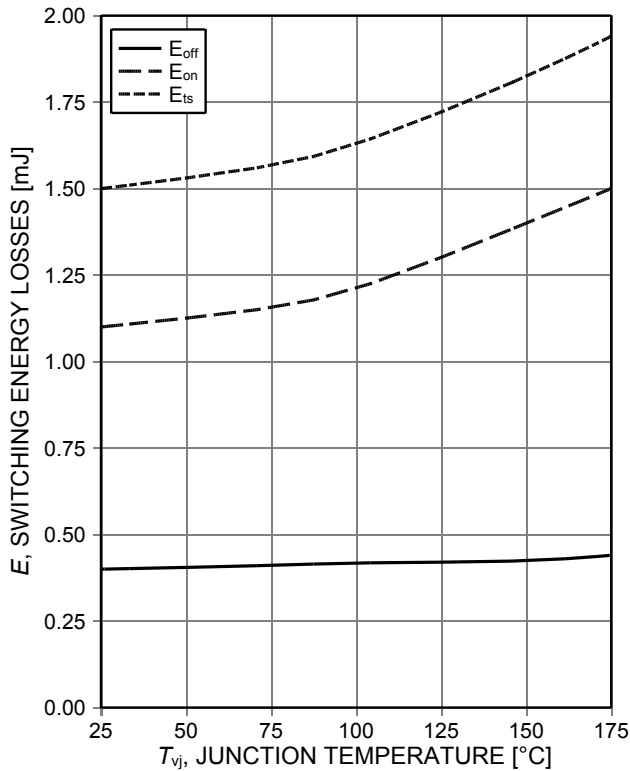

Figure 13. **Typical switching energy losses as a function of junction temperature**  
 (inductive load,  $V_{CE}=400V$ ,  $V_{GE}=15/0V$ ,  $I_C=40A$ ,  $R_G=15\Omega$ , Dynamic test circuit in Figure E)

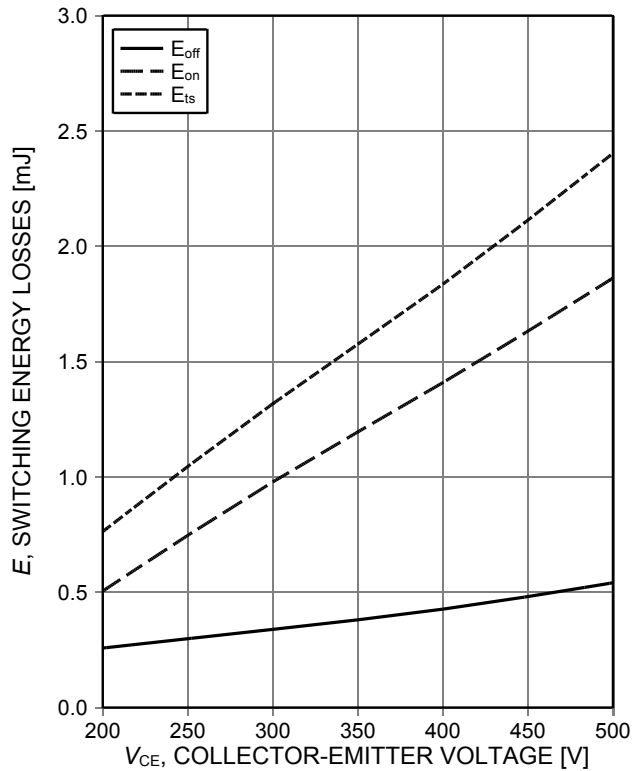

Figure 14. **Typical switching energy losses as a function of collector emitter voltage**  
 (inductive load,  $T_{vj}=150^\circ C$ ,  $V_{GE}=15/0V$ ,  $I_C=40A$ ,  $R_G=15\Omega$ , Dynamic test circuit in Figure E)

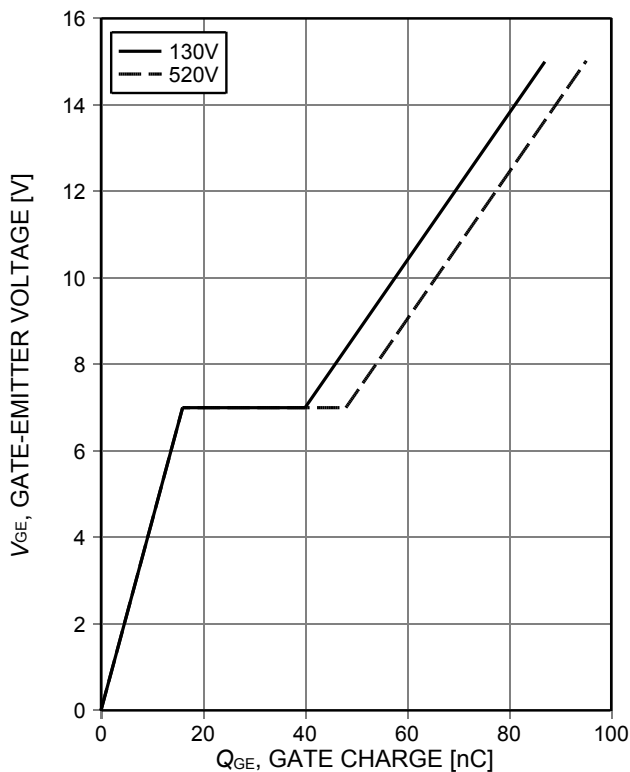

Figure 15. **Typical gate charge**  
 ( $I_C=40A$ )

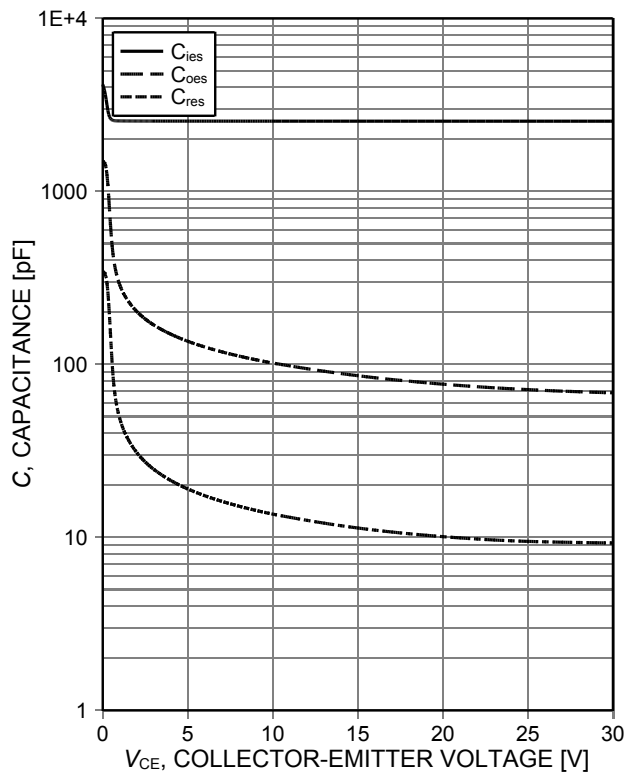

Figure 16. **Typical capacitance as a function of collector-emitter voltage**  
 ( $V_{GE}=0V$ ,  $f=1MHz$ )

High speed switching series 5<sup>th</sup> generation

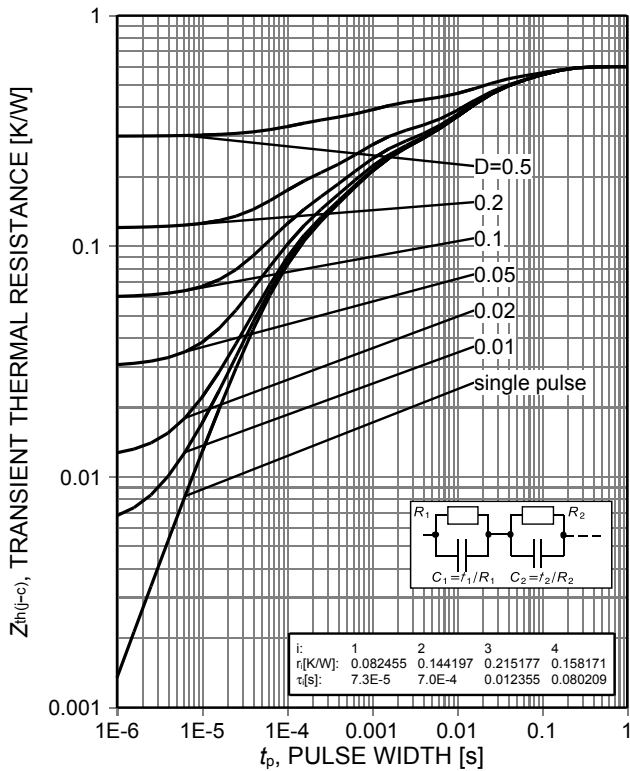

Figure 17. IGBT transient thermal resistance ( $D=t_p/T$ )

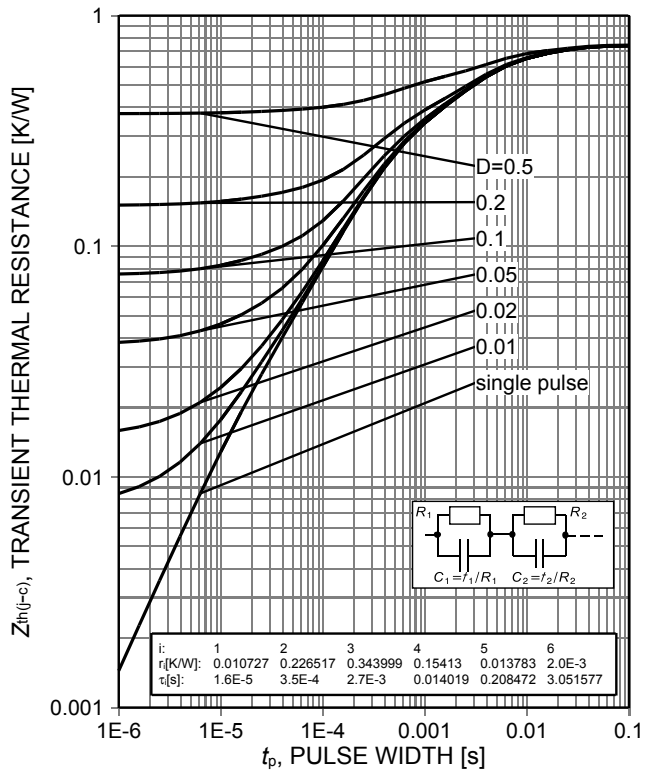

Figure 18. Diode transient thermal impedance as a function of pulse width ( $D=t_p/T$ )

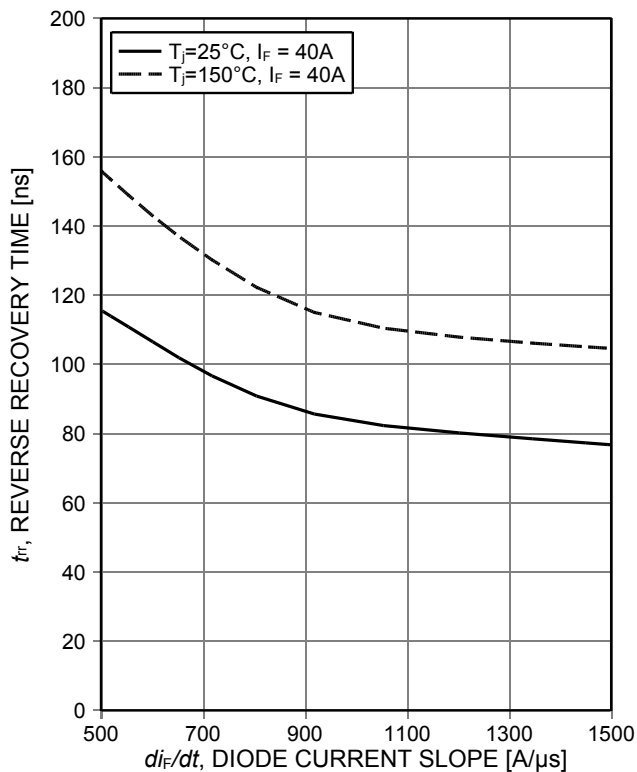

Figure 19. Typical reverse recovery time as a function of diode current slope ( $V_R=400V$ )

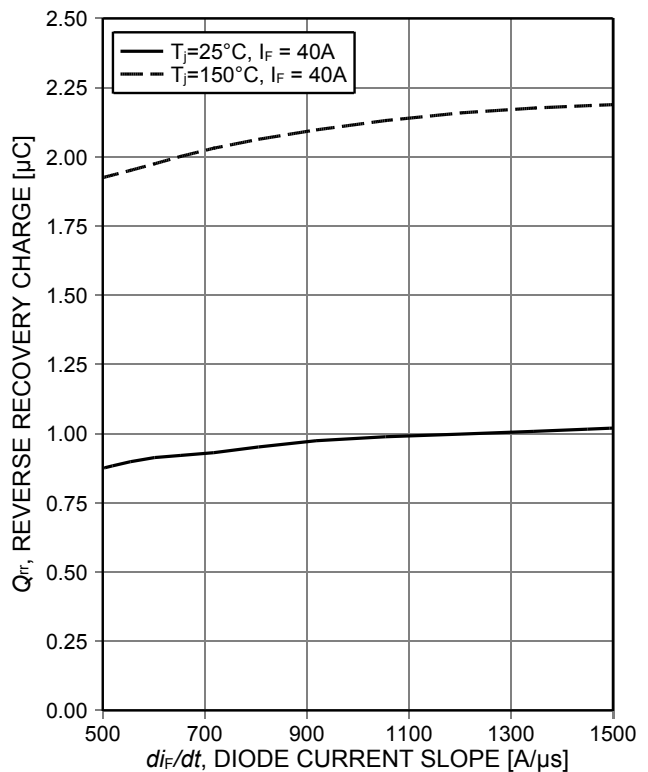

Figure 20. Typical reverse recovery charge as a function of diode current slope ( $V_R=400V$ )

High speed switching series 5<sup>th</sup> generation

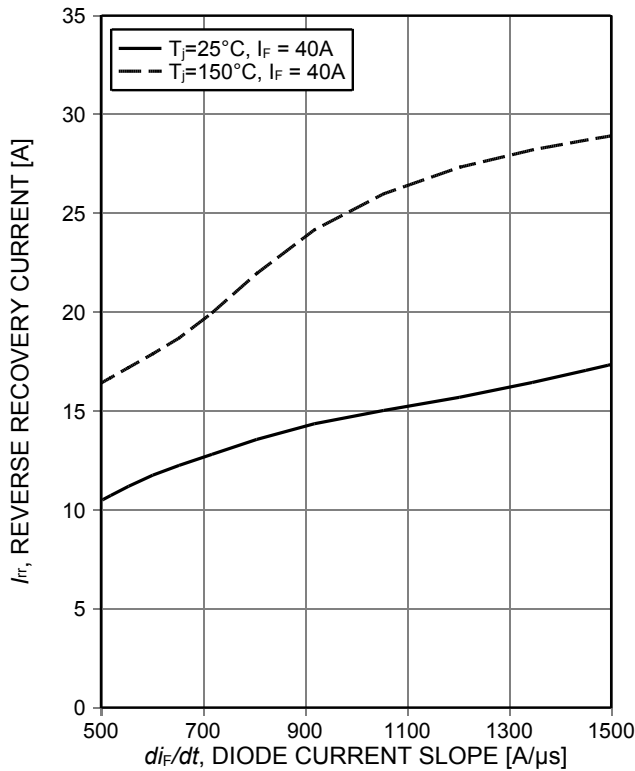

Figure 21. Typical reverse recovery current as a function of diode current slope (V<sub>R</sub>=400V)

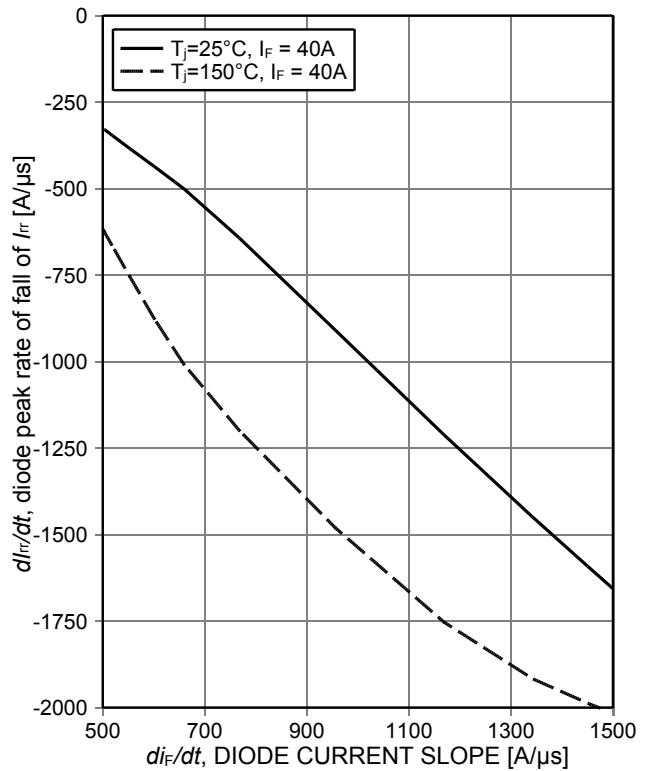

Figure 22. Typical diode peak rate of fall of reverse recovery current as a function of diode current slope (V<sub>R</sub>=400V)

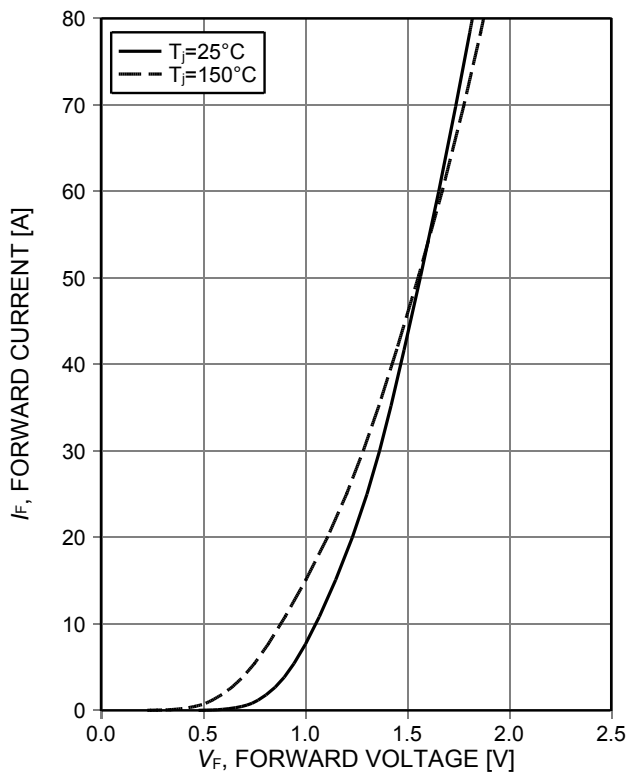

Figure 23. Typical diode forward current as a function of forward voltage

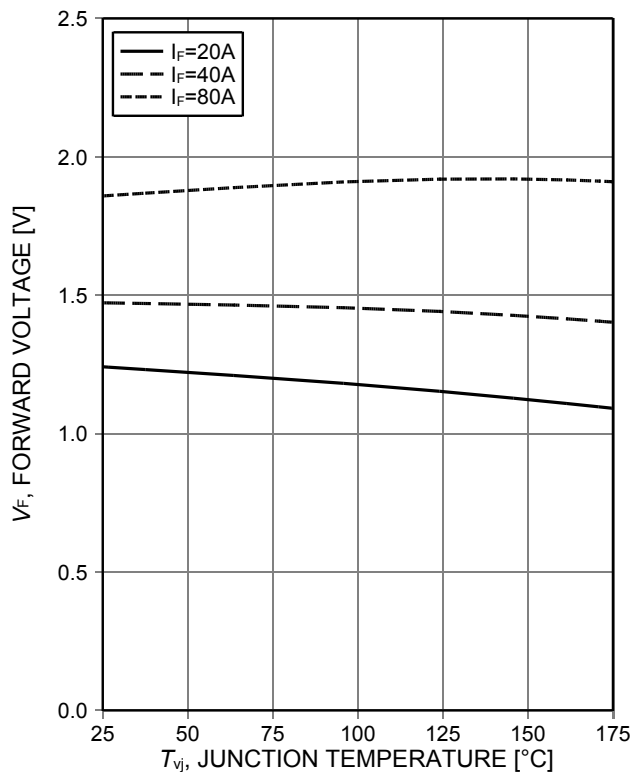
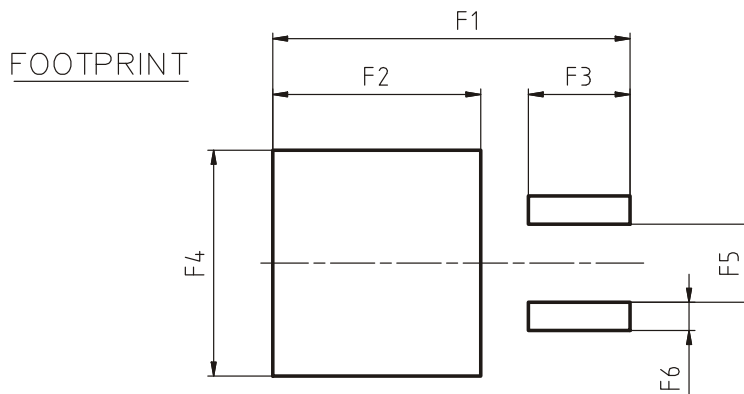
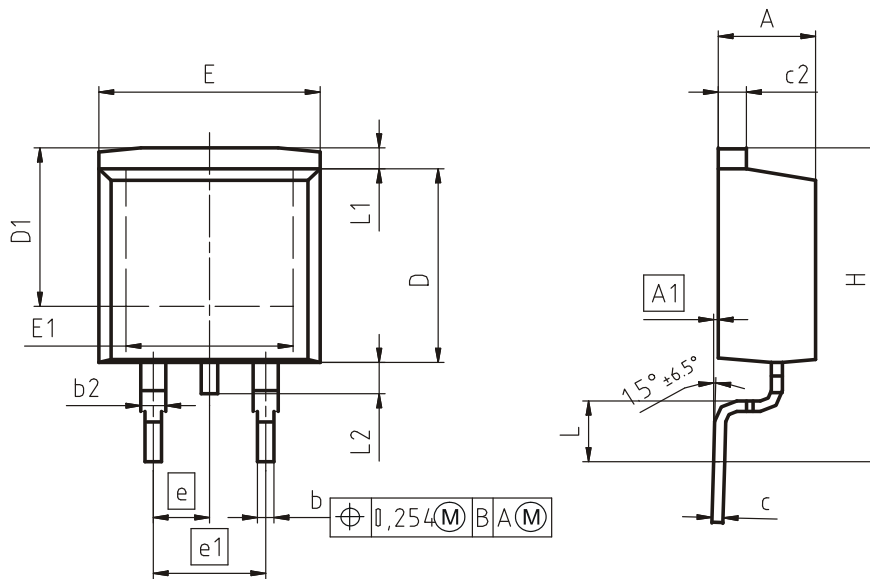

Figure 24. Typical diode forward voltage as a function of junction temperature

Package Drawing PG-TO263-3



| DIM | MILLIMETERS |       | INCHES |       |
|-----|-------------|-------|--------|-------|
|     | MIN         | MAX   | MIN    | MAX   |
| A   | 4.30        | 4.57  | 0.169  | 0.180 |
| A1  | 0.00        | 0.25  | 0.000  | 0.010 |
| b   | 0.65        | 0.85  | 0.026  | 0.033 |
| b2  | 0.95        | 1.15  | 0.037  | 0.045 |
| c   | 0.33        | 0.65  | 0.013  | 0.026 |
| c2  | 1.17        | 1.40  | 0.046  | 0.055 |
| D   | 8.51        | 9.45  | 0.335  | 0.372 |
| D1  | 7.10        | 7.90  | 0.280  | 0.311 |
| E   | 9.80        | 10.31 | 0.386  | 0.406 |
| E1  | 6.50        | 8.60  | 0.256  | 0.339 |
| e   | 2.54        |       | 0.100  |       |
| e1  | 5.08        |       | 0.200  |       |
| N   | 2           |       | 2      |       |
| H   | 14.61       | 15.88 | 0.575  | 0.625 |
| L   | 2.29        | 3.00  | 0.090  | 0.118 |
| L1  | 0.70        | 1.60  | 0.028  | 0.063 |
| L2  | 1.00        | 1.78  | 0.039  | 0.070 |
| F1  | 16.05       | 16.25 | 0.632  | 0.640 |
| F2  | 9.30        | 9.50  | 0.366  | 0.374 |
| F3  | 4.50        | 4.70  | 0.177  | 0.185 |
| F4  | 10.70       | 10.90 | 0.421  | 0.429 |
| F5  | 3.65        | 3.85  | 0.144  | 0.152 |
| F6  | 1.25        | 1.45  | 0.049  | 0.057 |

DOCUMENT NO.  
Z8B00003324

SCALE

7.5mm

EUROPEAN PROJECTION

ISSUE DATE  
30-08-2007

REVISION  
01

Testing Conditions

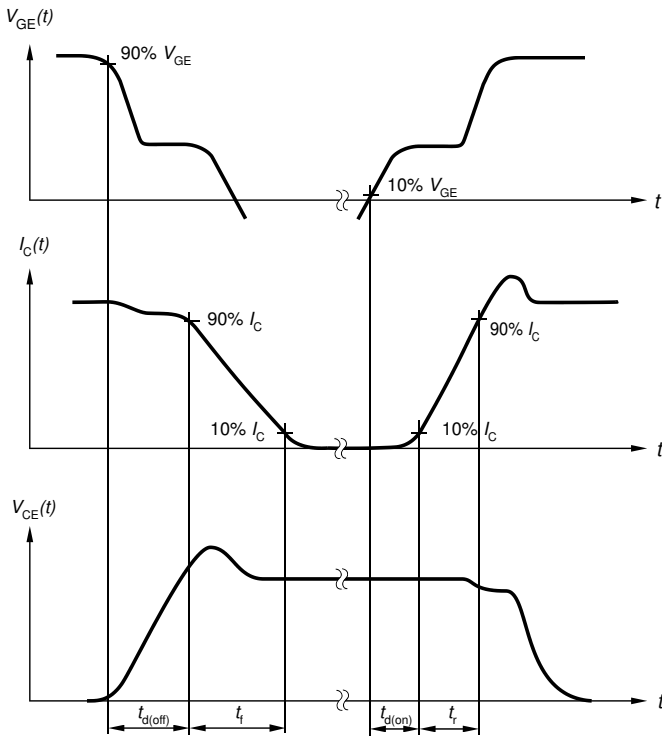

Figure A. Definition of switching times

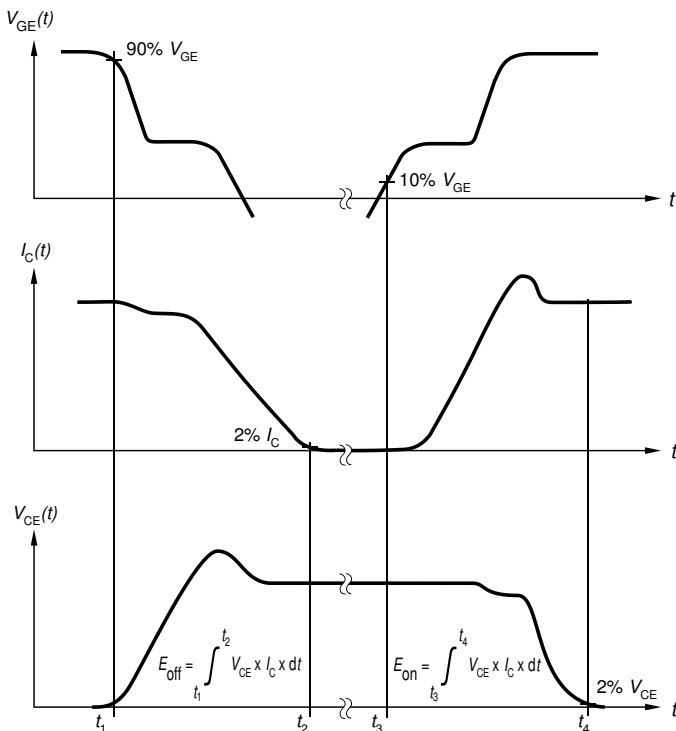

Figure B. Definition of switching losses

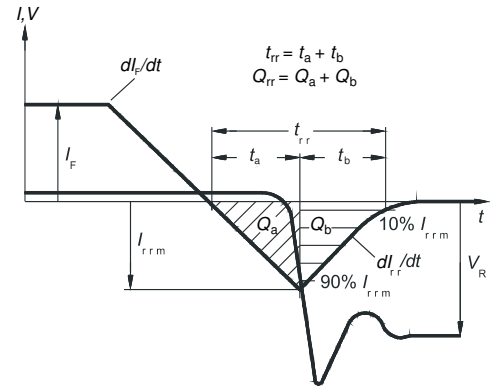

Figure C. Definition of diode switching characteristics

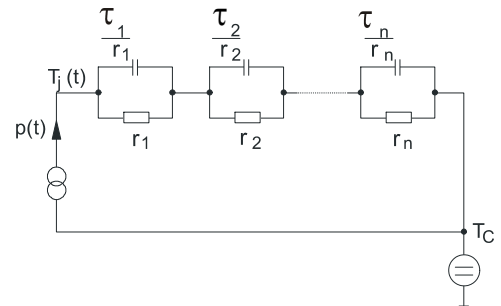

Figure D. Thermal equivalent circuit

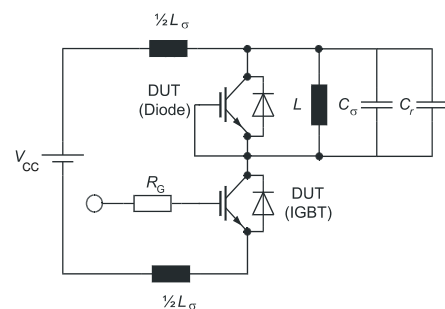

Figure E. Dynamic test circuit  
Parasitic inductance  $L_{\sigma}$ ,  
parasitic capacitor  $C_{\sigma}$ ,  
relief capacitor  $C_r$ ,  
(only for ZVT switching)

---

High speed switching series 5<sup>th</sup> generation

## Revision History

---

IKB40N65EH5

**Revision: 2018-04-04, Rev. 2.1**

---

Previous Revision

---

| Revision | Date       | Subjects (major changes since last revision) |
|----------|------------|--|
| 2.1      | 2018-04-04 | Final data sheet                             |



## Trademarks

All referenced product or service names and trademarks are the property of their respective owners.

**Published by**  
**Infineon Technologies AG**  
**81726 München, Germany**  
**© Infineon Technologies AG 2018.**  
**All Rights Reserved.**

## Important Notice

The information given in this document shall in no event be regarded as a guarantee of conditions or characteristics ("Beschaffenheitsgarantie"). With respect to any examples, hints or any typical values stated herein and/or any information regarding the application of the product, Infineon Technologies hereby disclaims any and all warranties and liabilities of any kind, including without limitation warranties of non-infringement of intellectual property rights of any third party.

In addition, any information given in this document is subject to customer's compliance with its obligations stated in this document and any applicable legal requirements, norms and standards concerning customer's products and any use of the product of Infineon Technologies in customer's applications.

The data contained in this document is exclusively intended for technically trained staff. It is the responsibility of customer's technical departments to evaluate the suitability of the product for the intended application and the completeness of the product information given in this document with respect to such application.

For further information on the product, technology, delivery terms and conditions and prices please contact your nearest Infineon Technologies office ([www.infineon.com](http://www.infineon.com)).

Please note that this product is not qualified according to the AEC Q100 or AEC Q101 documents of the Automotive Electronics Council.

## Warnings

Due to technical requirements products may contain dangerous substances. For information on the types in question please contact your nearest Infineon Technologies office.

Except as otherwise explicitly approved by Infineon Technologies in a written document signed by authorized representatives of Infineon Technologies, Infineon Technologies' products may not be used in any applications where a failure of the product or any consequences of the use thereof can reasonably be expected to result in personal injury.