



Chipsmall Limited consists of a professional team with an average of over 10 year of expertise in the distribution of electronic components. Based in Hongkong, we have already established firm and mutual-benefit business relationships with customers from,Europe,America and south Asia,supplying obsolete and hard-to-find components to meet their specific needs.

With the principle of “Quality Parts,Customers Priority,Honest Operation,and Considerate Service”,our business mainly focus on the distribution of electronic components. Line cards we deal with include Microchip,ALPS,ROHM,Xilinx,Pulse,ON,Everlight and Freescale. Main products comprise IC,Modules,Potentiometer,IC Socket,Relay,Connector.Our parts cover such applications as commercial,industrial, and automotives areas.

We are looking forward to setting up business relationship with you and hope to provide you with the best service and solution. Let us make a better world for our industry!



Contact us

Tel: +86-755-8981 8866 Fax: +86-755-8427 6832

Email & Skype: info@chipsmall.com Web: www.chipsmall.com

Address: A1208, Overseas Decoration Building, #122 Zhenhua RD., Futian, Shenzhen, China



IGBT

Low Loss DuoPack : IGBT in TRENCHSTOP™ and Fieldstop technology with soft, fast recovery antiparallel Emitter Controlled diode

IKQ100N60TA

600V low loss switching series third generation

Data sheet

Low Loss DuoPack : IGBT in TRENCHSTOP™ and Fieldstop technology with soft, fast recovery antiparallel Emitter Controlled diode

Features:

- Automotive AEC-Q101 qualified
- Designed for DC/AC converters for Automotive Application
- Very low $V_{CE(sat)}$ 1.5 V (typ.)
- Maximum junction temperature 175°C
- Short circuit withstand time 5µs
- 100% short circuit tested
- 100% of the parts are dynamically tested
- TRENCHSTOP™ and Fieldstop technology for 600V

applications offers:

- very tight parameter distribution
- high ruggedness, temperature stable behavior
- very high switching speed
- Positive temperature coefficient in $V_{CE(sat)}$
- Low EMI
- Low gate charge Q_G
- Green package
- Very soft, fast recovery antiparallel Emitter Controlled HE diode

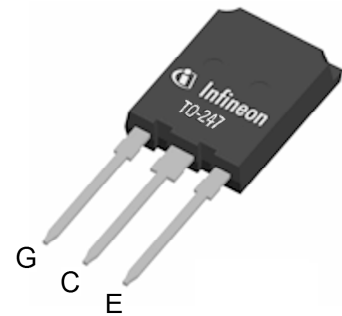
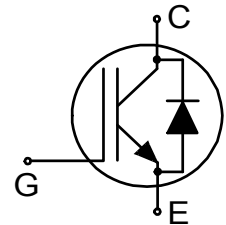

Applications:

- Main inverter
- Air-Con compressor
- PTC heater
- Motor drives



Key Performance and Package Parameters

Type	V_{CE}	I_C	$V_{CEsat}, T_{vj}=25^{\circ}C$	T_{vjmax}	Marking	Package
IKQ100N60TA	600V	100A	1.5V	175°C	K100T60A	PG-TO247-3



Table of Contents

Description 2

Table of Contents 3

Maximum Ratings 4

Thermal Resistance 4

Electrical Characteristics 5

Electrical Characteristics Diagrams 8

Package Drawing15

Testing Conditions16

Revision History17

Disclaimer17

Maximum Ratings

For optimum lifetime and reliability, Infineon recommends operating conditions that do not exceed 80% of the maximum ratings stated in this datasheet.

Parameter	Symbol	Value	Unit
Collector-emitter voltage, $T_{vj} \geq 25^{\circ}\text{C}$	V_{CE}	600	V
DC collector current, limited by T_{vjmax} $T_C = 25^{\circ}\text{C}$ value limited by bondwire $T_C = 130^{\circ}\text{C}$	I_C	160.0 100.0	A
Pulsed collector current, t_p limited by T_{vjmax}	I_{Cpuls}	400.0	A
Turn off safe operating area $V_{CE} \leq 600\text{V}$, $T_{vj} \leq 175^{\circ}\text{C}$, $t_p = 1\mu\text{s}$	-	400.0	A
Diode forward current, limited by T_{vjmax} $T_C = 25^{\circ}\text{C}$ value limited by bondwire $T_C = 117^{\circ}\text{C}$	I_F	160.0 100.0	A
Diode pulsed current, t_p limited by T_{vjmax}	I_{Fpuls}	400.0	A
Gate-emitter voltage	V_{GE}	± 20	V
Short circuit withstand time $V_{GE} = 15.0\text{V}$, $V_{CC} \leq 400\text{V}$ Allowed number of short circuits < 1000 Time between short circuits: $\geq 1.0\text{s}$ $T_{vj} = 150^{\circ}\text{C}$	t_{SC}	5	μs
Power dissipation $T_C = 25^{\circ}\text{C}$	P_{tot}	714.0	W
Operating junction temperature	T_{vj}	-40...+175	$^{\circ}\text{C}$
Storage temperature	T_{stg}	-55...+150	$^{\circ}\text{C}$
Soldering temperature, ¹⁾ wave soldering 1.6mm (0.063in.) from case for 10s		260	$^{\circ}\text{C}$
Mounting torque, M3 screw Maximum of mounting processes: 3	M	0.6	Nm

Thermal Resistance

Parameter	Symbol	Conditions	Max. Value	Unit
Characteristic				
IGBT thermal resistance, ²⁾ junction - case	$R_{th(j-c)}$		0.21	K/W
Diode thermal resistance, ²⁾ junction - case	$R_{th(j-c)}$		0.35	K/W
Thermal resistance junction - ambient	$R_{th(j-a)}$		40	K/W

¹⁾ Package not recommended for surface mount application

²⁾ Thermal resistance of thermal grease $R_{th(c-s)}$ (case to heat sink) of more than 0.1K/W not included.

Electrical Characteristic, at $T_{vj} = 25^{\circ}\text{C}$, unless otherwise specified

Parameter	Symbol	Conditions	Value			Unit
			min.	typ.	max.	
Static Characteristic						
Collector-emitter breakdown voltage	$V_{(BR)CES}$	$V_{GE} = 0\text{V}, I_C = 0.20\text{mA}$	600	-	-	V
Collector-emitter saturation voltage	V_{CESat}	$V_{GE} = 15.0\text{V}, I_C = 100.0\text{A}$ $T_{vj} = 25^{\circ}\text{C}$ $T_{vj} = 175^{\circ}\text{C}$	- -	1.50 1.90	2.00 -	V
Diode forward voltage	V_F	$V_{GE} = 0\text{V}, I_F = 100.0\text{A}$ $T_{vj} = 25^{\circ}\text{C}$ $T_{vj} = 175^{\circ}\text{C}$	- -	1.65 1.60	2.05 -	V
Gate-emitter threshold voltage	$V_{GE(th)}$	$I_C = 1.60\text{mA}, V_{CE} = V_{GE}$	4.1	4.9	5.7	V
Zero gate voltage collector current	I_{CES}	$V_{CE} = 600\text{V}, V_{GE} = 0\text{V}$ $T_{vj} = 25^{\circ}\text{C}$ $T_{vj} = 175^{\circ}\text{C}$	- -	- 2500.0	40.0 -	μA
Gate-emitter leakage current	I_{GES}	$V_{CE} = 0\text{V}, V_{GE} = 20\text{V}$	-	-	100	nA
Transconductance	g_{fs}	$V_{CE} = 20\text{V}, I_C = 100.0\text{A}$	-	63.0	-	S
Integrated gate resistor	r_G			none		Ω

Electrical Characteristic, at $T_{vj} = 25^{\circ}\text{C}$, unless otherwise specified

Parameter	Symbol	Conditions	Value			Unit
			min.	typ.	max.	
Dynamic Characteristic						
Input capacitance	C_{ies}	$V_{CE} = 25\text{V}, V_{GE} = 0\text{V}, f = 1\text{MHz}$	-	6230	-	pF
Output capacitance	C_{oes}		-	360	-	
Reverse transfer capacitance	C_{res}		-	175	-	
Gate charge	Q_G	$V_{CC} = 480\text{V}, I_C = 100.0\text{A},$ $V_{GE} = 15\text{V}$	-	610.0	-	nC
Internal emitter inductance measured 5mm (0.197 in.) from case	L_E		-	13.0	-	nH
Short circuit collector current Max. 1000 short circuits Time between short circuits: $\geq 1.0\text{s}$	$I_{C(SC)}$	$V_{GE} = 15.0\text{V}, V_{CC} \leq 400\text{V},$ $t_{SC} \leq 5\mu\text{s}$ $T_{vj} = 150^{\circ}\text{C}$	-	802	-	A

Switching Characteristic, Inductive Load

Parameter	Symbol	Conditions	Value			Unit
			min.	typ.	max.	
IGBT Characteristic, at $T_{vj} = 25^{\circ}\text{C}$						
Turn-on delay time	$t_{d(on)}$	$T_{vj} = 25^{\circ}\text{C}$, $V_{CC} = 400\text{V}$, $I_C = 100.0\text{A}$, $V_{GE} = 0.0/15.0\text{V}$, $R_{G(on)} = 3.6\Omega$, $R_{G(off)} = 3.6\Omega$, $L\sigma = 63\text{nH}$, $C\sigma = 31\text{pF}$ $L\sigma$, $C\sigma$ from Fig. E Energy losses include "tail" and diode reverse recovery.	-	30	-	ns
Rise time	t_r		-	38	-	ns
Turn-off delay time	$t_{d(off)}$		-	290	-	ns
Fall time	t_f		-	31	-	ns
Turn-on energy	E_{on}		-	3.10	-	mJ
Turn-off energy	E_{off}		-	2.50	-	mJ
Total switching energy	E_{ts}		-	5.60	-	mJ

Diode Characteristic, at $T_{vj} = 25^{\circ}\text{C}$

Diode reverse recovery time	t_{rr}	$T_{vj} = 25^{\circ}\text{C}$, $V_R = 400\text{V}$, $I_F = 100.0\text{A}$, $di_F/dt = 1100\text{A}/\mu\text{s}$	-	225	-	ns
Diode reverse recovery charge	Q_{rr}		-	2.80	-	μC
Diode peak reverse recovery current	I_{rrm}		-	23.0	-	A
Diode peak rate of fall of reverse recovery current during t_b	di_{rr}/dt		-	-393	-	$\text{A}/\mu\text{s}$

Switching Characteristic, Inductive Load

Parameter	Symbol	Conditions	Value			Unit
			min.	typ.	max.	
IGBT Characteristic, at $T_{vj} = 175^{\circ}\text{C}$						
Turn-on delay time	$t_{d(on)}$	$T_{vj} = 175^{\circ}\text{C}$, $V_{CC} = 400\text{V}$, $I_C = 100.0\text{A}$, $V_{GE} = 0.0/15.0\text{V}$, $R_{G(on)} = 3.6\Omega$, $R_{G(off)} = 3.6\Omega$, $L\sigma = 63\text{nH}$, $C\sigma = 31\text{pF}$ $L\sigma$, $C\sigma$ from Fig. E Energy losses include "tail" and diode reverse recovery.	-	31	-	ns
Rise time	t_r		-	52	-	ns
Turn-off delay time	$t_{d(off)}$		-	351	-	ns
Fall time	t_f		-	42	-	ns
Turn-on energy	E_{on}		-	6.00	-	mJ
Turn-off energy	E_{off}		-	3.70	-	mJ
Total switching energy	E_{ts}		-	9.70	-	mJ

Diode Characteristic, at $T_{vj} = 175^{\circ}\text{C}$

Diode reverse recovery time	t_{rr}	$T_{vj} = 175^{\circ}\text{C}$, $V_R = 400\text{V}$, $I_F = 100.0\text{A}$, $di_F/dt = 1050\text{A}/\mu\text{s}$	-	300	-	ns
Diode reverse recovery charge	Q_{rr}		-	8.70	-	μC
Diode peak reverse recovery current	I_{rrm}		-	50.0	-	A
Diode peak rate of fall of reverse recovery current during t_b	di_{rr}/dt		-	-847	-	$\text{A}/\mu\text{s}$

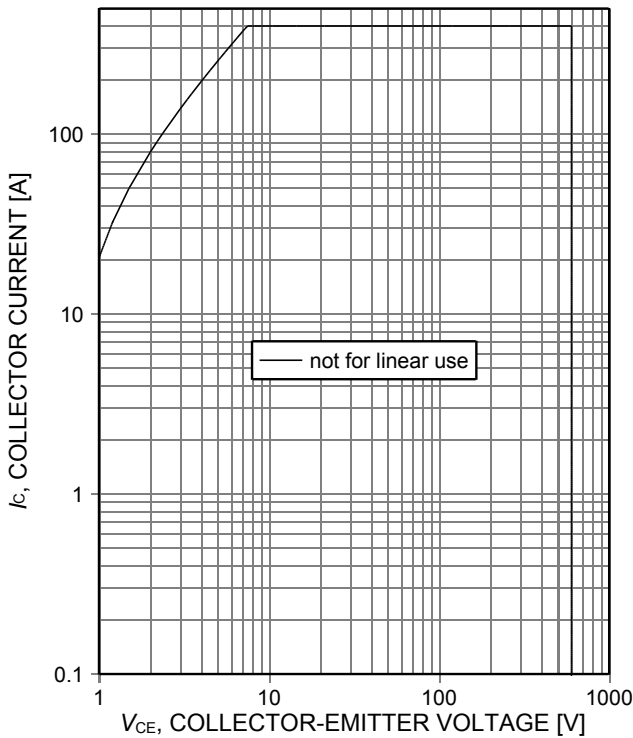

Figure 1. **Safe operating area**
 ($D=0$, $T_C=25^\circ\text{C}$, $T_J\leq 175^\circ\text{C}$, $V_{GE}=0/15\text{V}$,
 $t_p=1\mu\text{s}$. Proven by production test.)

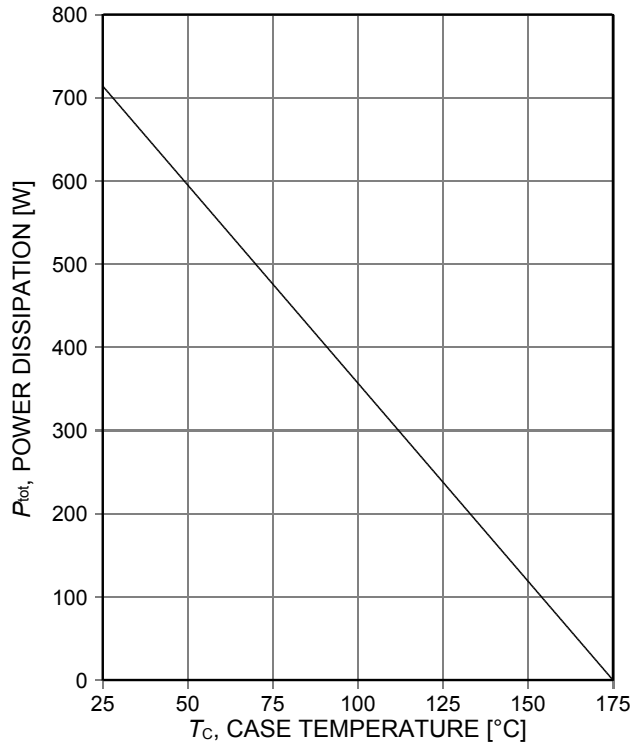

Figure 2. **Power dissipation as a function of case temperature**
 ($T_J\leq 175^\circ\text{C}$)

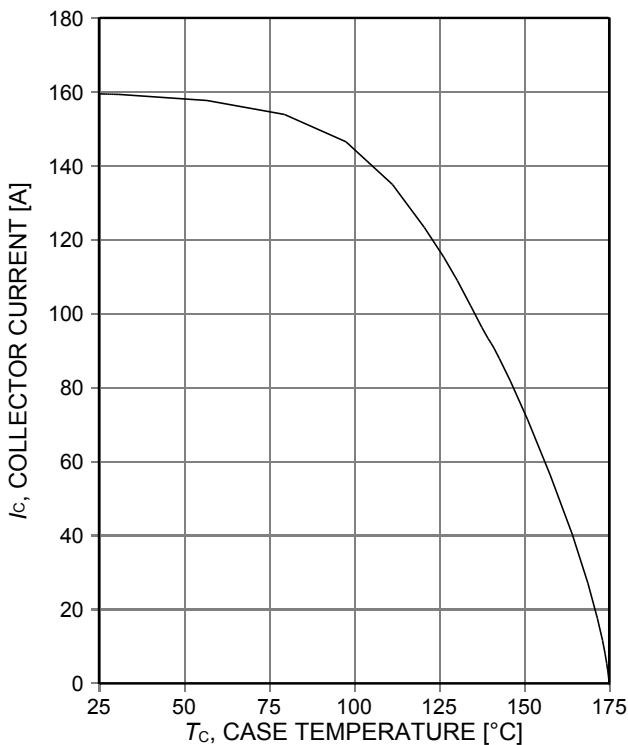

Figure 3. **Collector current as a function of case temperature**
 ($V_{GE}\geq 15\text{V}$, $T_J\leq 175^\circ\text{C}$)

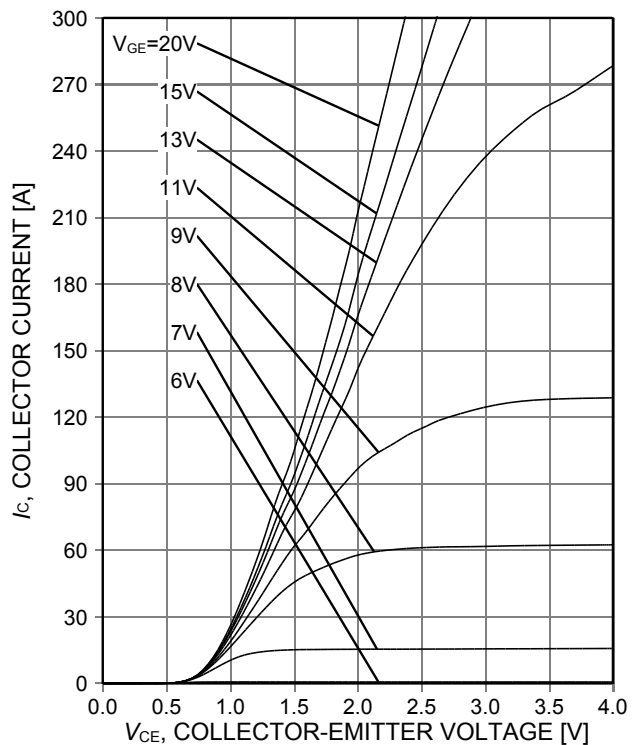

Figure 4. **Typical output characteristic**
 ($T_J=25^\circ\text{C}$)

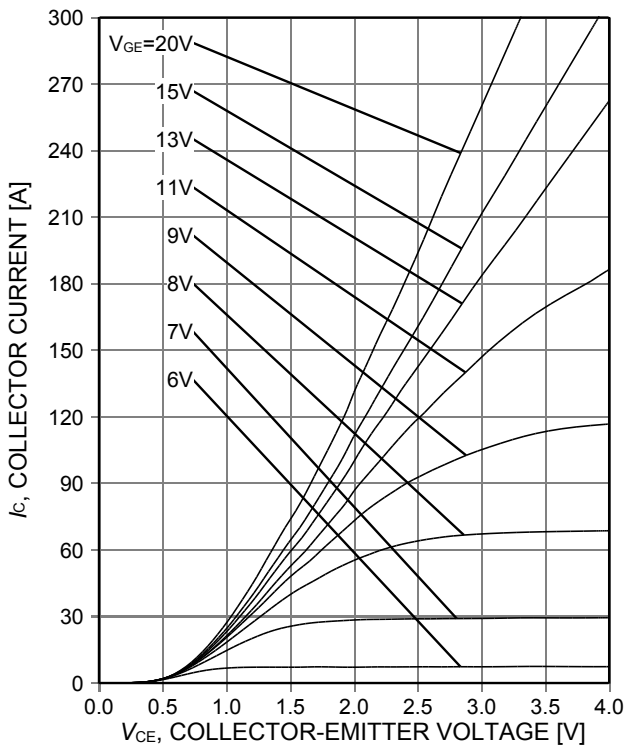

Figure 5. **Typical output characteristic**
($T_j=175^\circ\text{C}$)

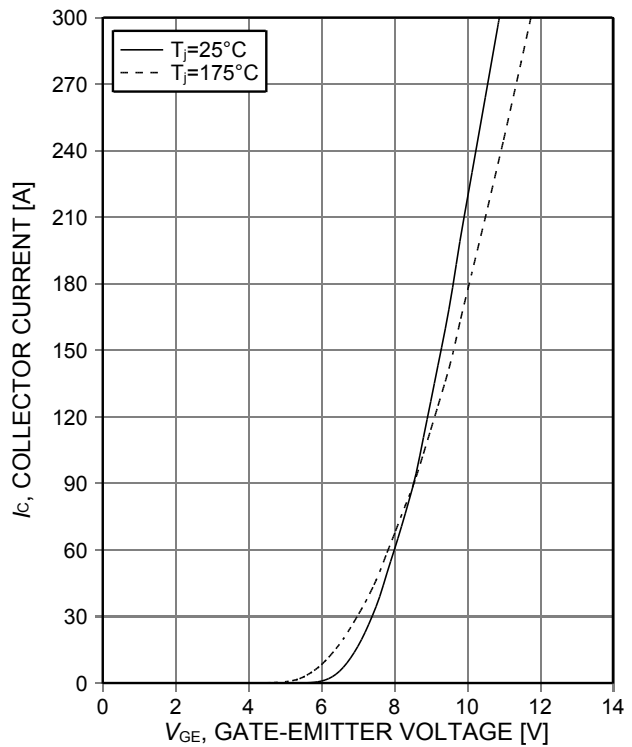

Figure 6. **Typical transfer characteristic**
($V_{CE}=20\text{V}$)

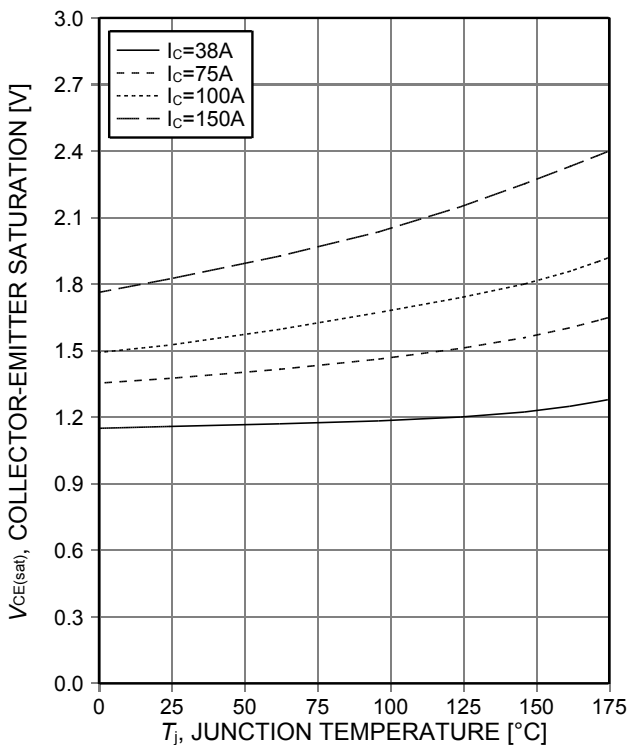

Figure 7. **Typical collector-emitter saturation voltage as a function of junction temperature**
($V_{GE}=15\text{V}$)

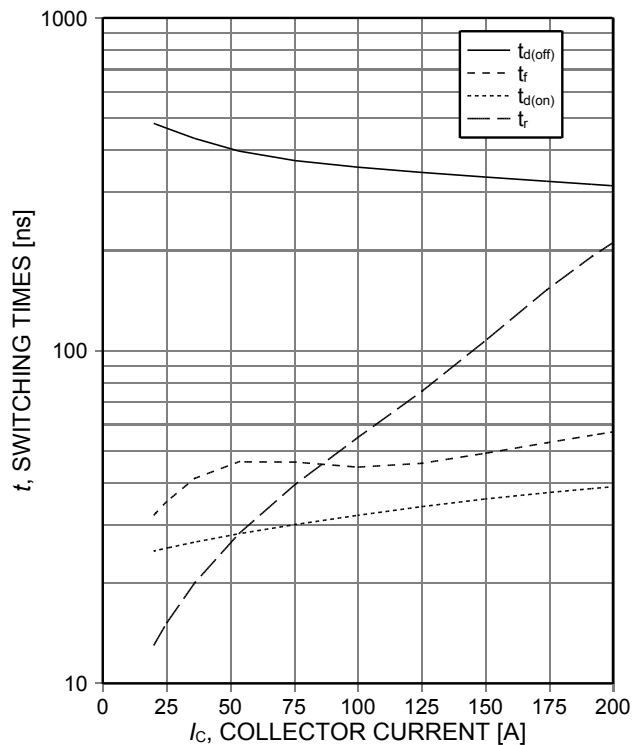

Figure 8. **Typical switching times as a function of collector current**
(inductive load, $T_j=175^\circ\text{C}$, $V_{CE}=400\text{V}$, $V_{GE}=15/0\text{V}$, $r_G=3,6\Omega$, Dynamic test circuit in Figure E)

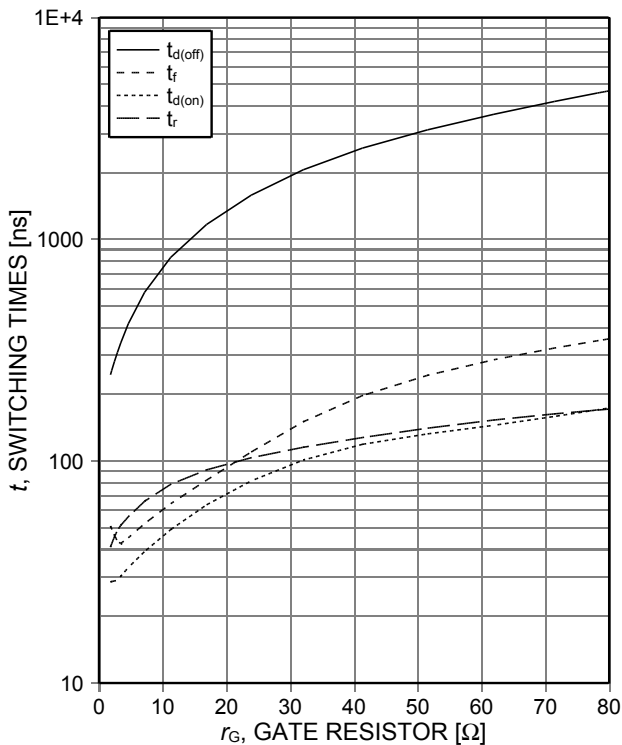

Figure 9. **Typical switching times as a function of gate resistor**
(inductive load, $T_j=175^\circ\text{C}$, $V_{CE}=400\text{V}$, $V_{GE}=15/0\text{V}$, $I_C=100\text{A}$, Dynamic test circuit in Figure E)

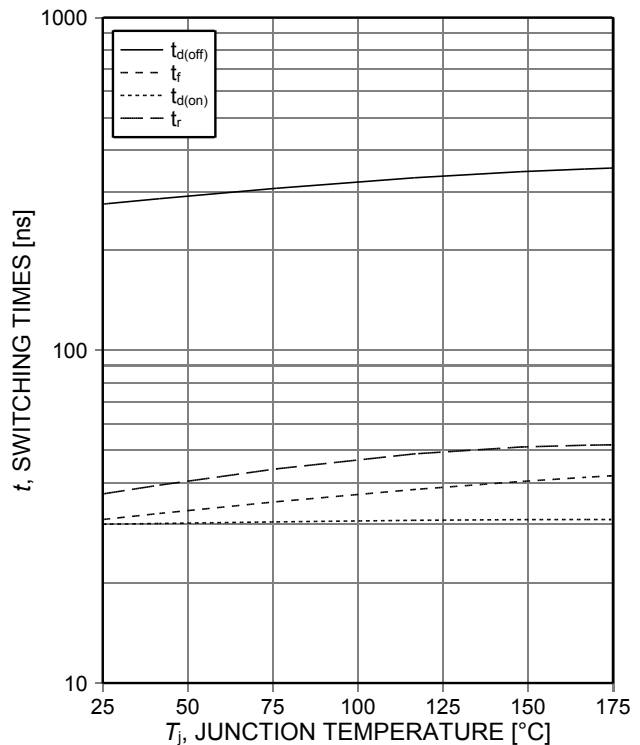

Figure 10. **Typical switching times as a function of junction temperature**
(inductive load, $V_{CE}=400\text{V}$, $V_{GE}=15/0\text{V}$, $I_C=100\text{A}$, $r_G=3,6\Omega$, Dynamic test circuit in Figure E)

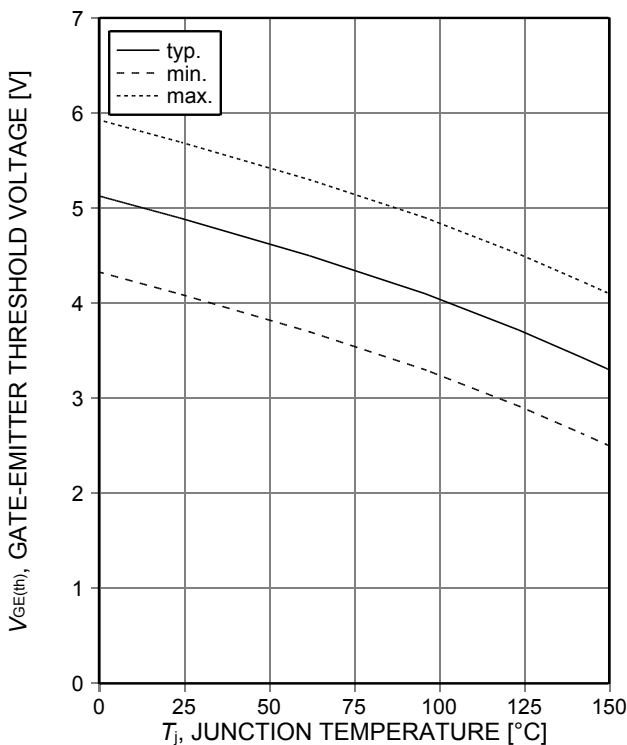

Figure 11. **Gate-emitter threshold voltage as a function of junction temperature**
($I_C=1.6\text{mA}$)

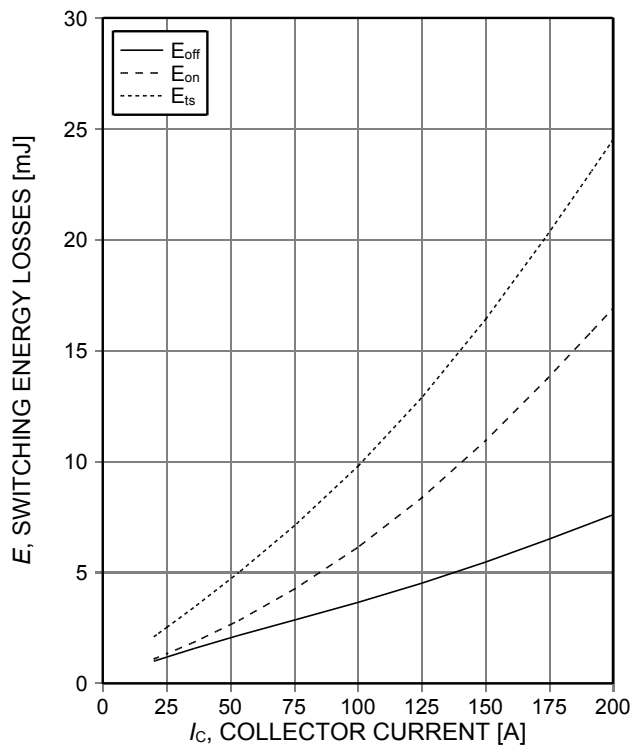

Figure 12. **Typical switching energy losses as a function of collector current**
(inductive load, $T_j=175^\circ\text{C}$, $V_{CE}=400\text{V}$, $V_{GE}=15/0\text{V}$, $r_G=3,6\Omega$, Dynamic test circuit in Figure E)

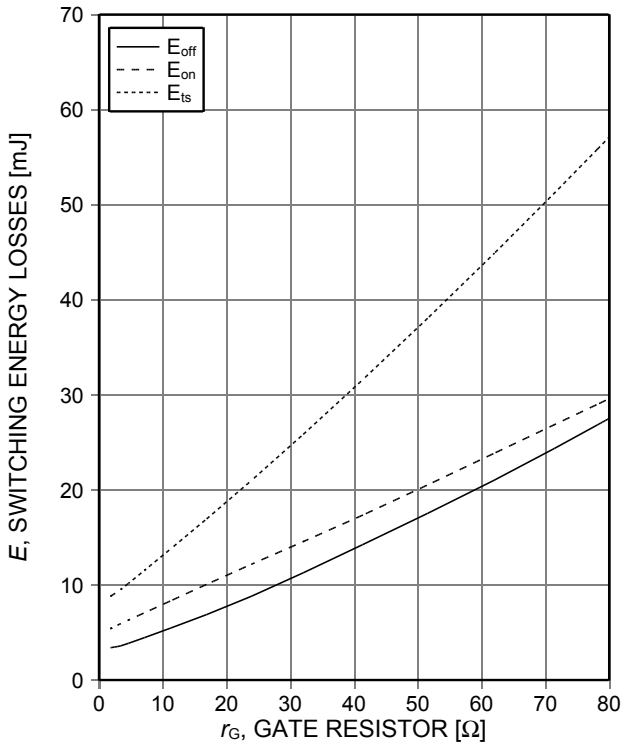

Figure 13. **Typical switching energy losses as a function of gate resistor**
 (inductive load, $T_j=175^\circ\text{C}$, $V_{CE}=400\text{V}$, $V_{GE}=15/0\text{V}$, $I_C=100\text{A}$, Dynamic test circuit in Figure E)

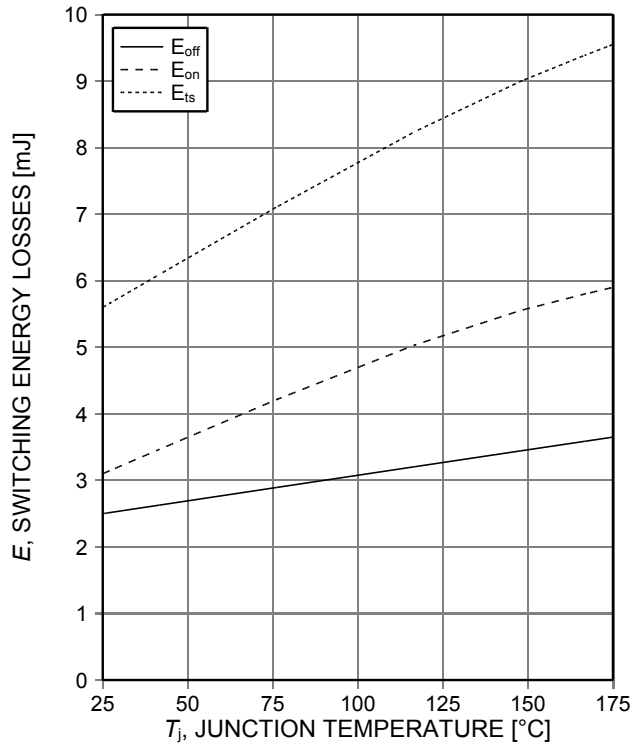

Figure 14. **Typical switching energy losses as a function of junction temperature**
 (inductive load, $V_{CE}=400\text{V}$, $V_{GE}=15/0\text{V}$, $I_C=100\text{A}$, $r_G=3,6\Omega$, Dynamic test circuit in Figure E)

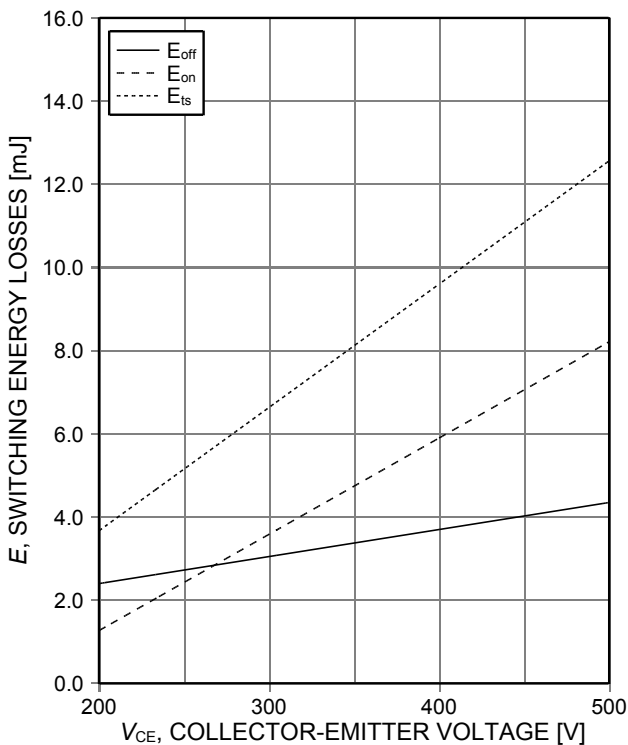

Figure 15. **Typical switching energy losses as a function of collector emitter voltage**
 (inductive load, $T_j=175^\circ\text{C}$, $V_{GE}=15/0\text{V}$, $I_C=100\text{A}$, $R_G=3,6\Omega$, Dynamic test circuit in Figure E)

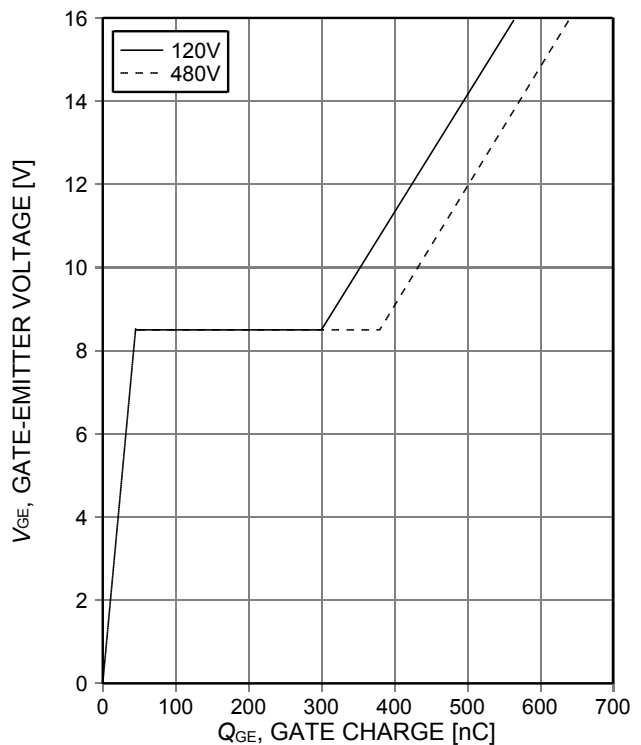

Figure 16. **Typical gate charge**
 ($I_C=100\text{A}$)

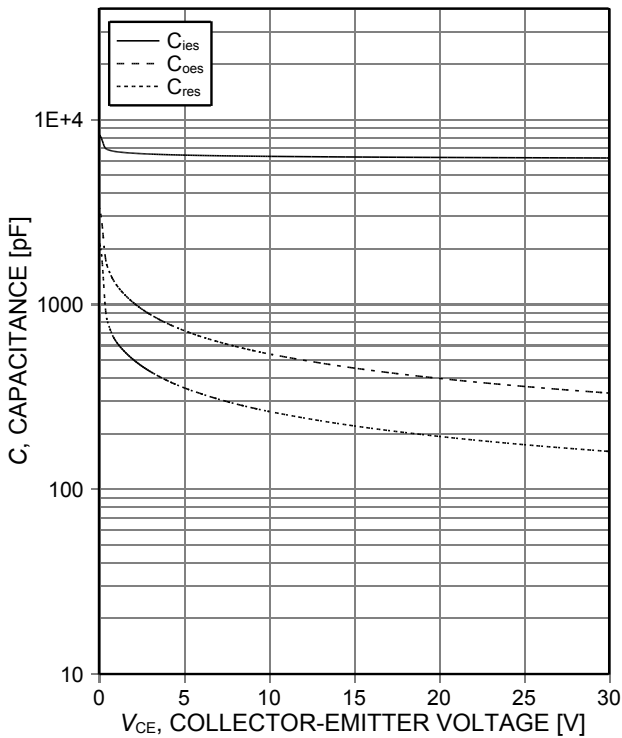

Figure 17. Typical capacitance as a function of collector-emitter voltage ($V_{GE}=0V$, $f=1MHz$)

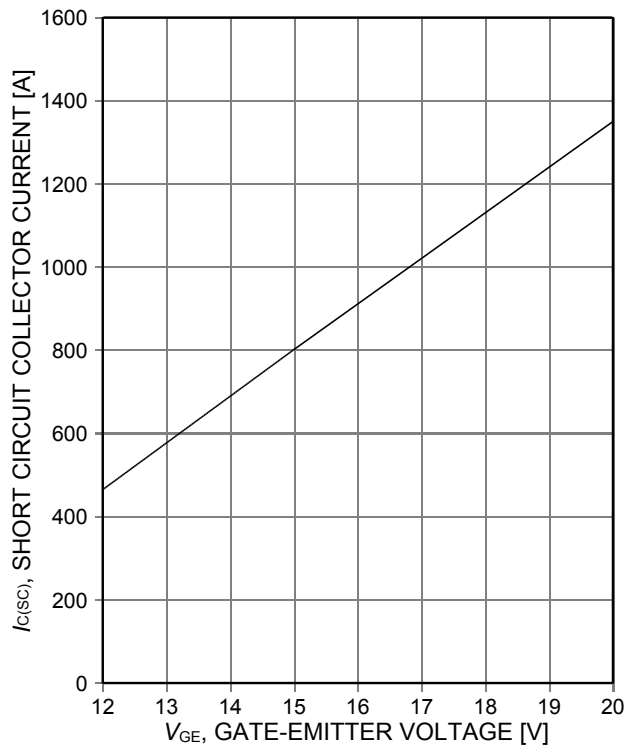

Figure 18. Typical short circuit collector current as a function of gate-emitter voltage ($V_{CE}\leq 400V$, start at $T_J\leq 150^\circ C$)

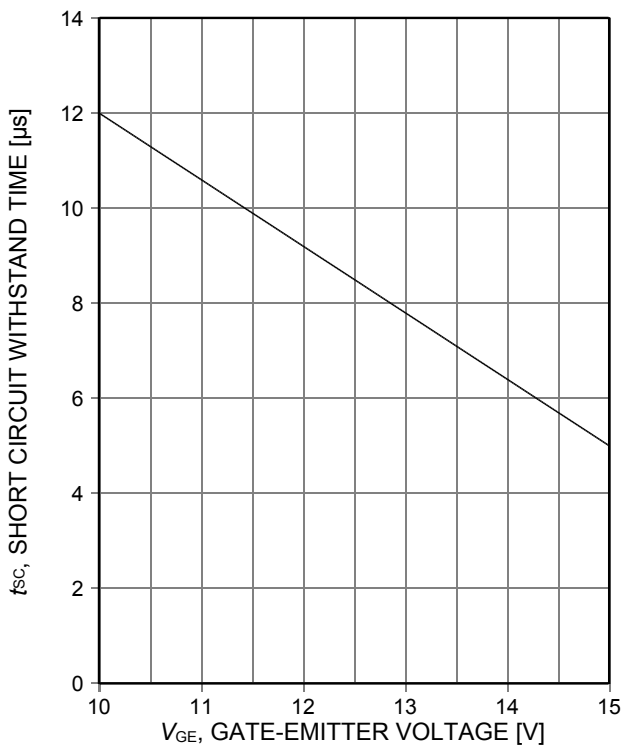

Figure 19. Short circuit withstand time as a function of gate-emitter voltage ($V_{CE}=400V$, start at $T_J=25^\circ C$, $T_{Jmax}\leq 150^\circ C$)

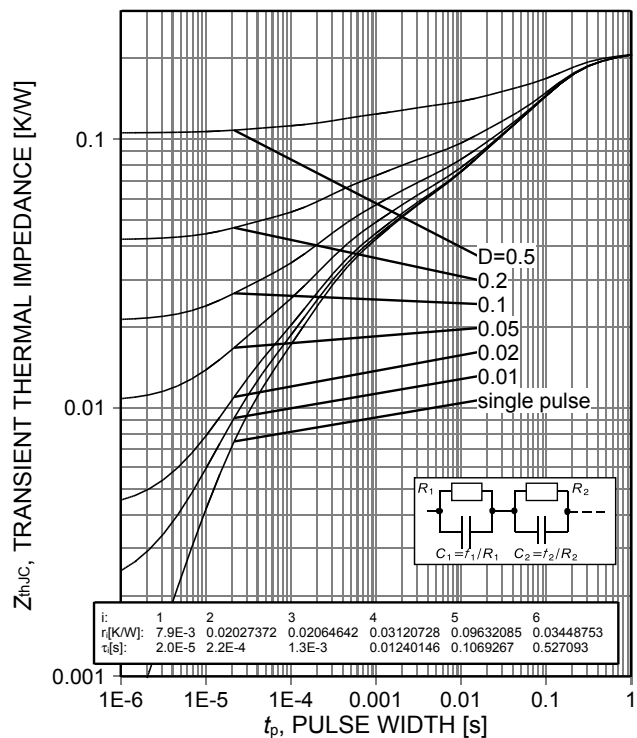

Figure 20. IGBT transient thermal impedance as a function of pulse width for different duty cycles D ($D=t_p/T$)

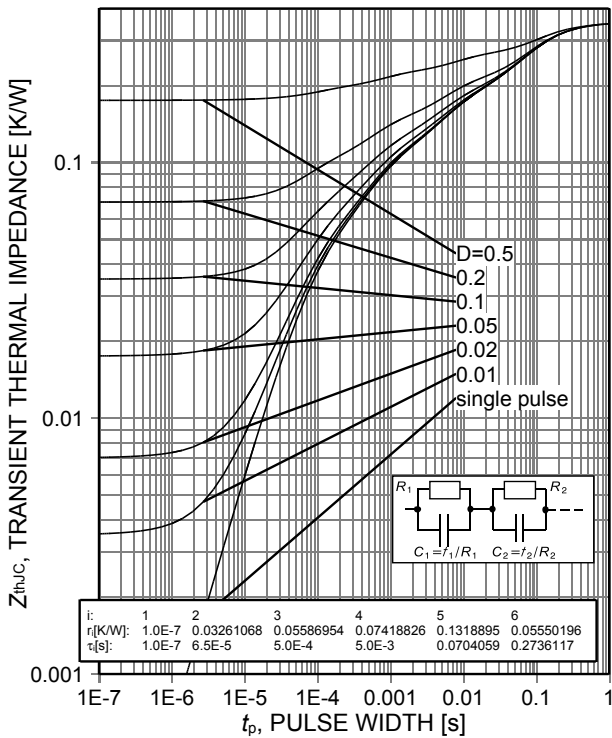

Figure 21. Diode transient thermal impedance as a function of pulse width for different duty cycles D ($D=t_p/T$)

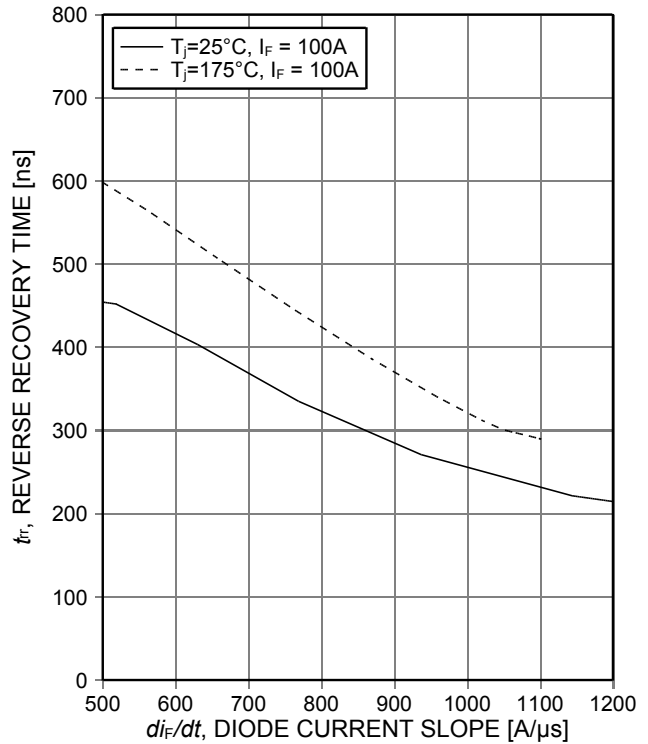

Figure 22. Typical reverse recovery time as a function of diode current slope ($V_R=400V$, Dynamic test circuit in Figure E)

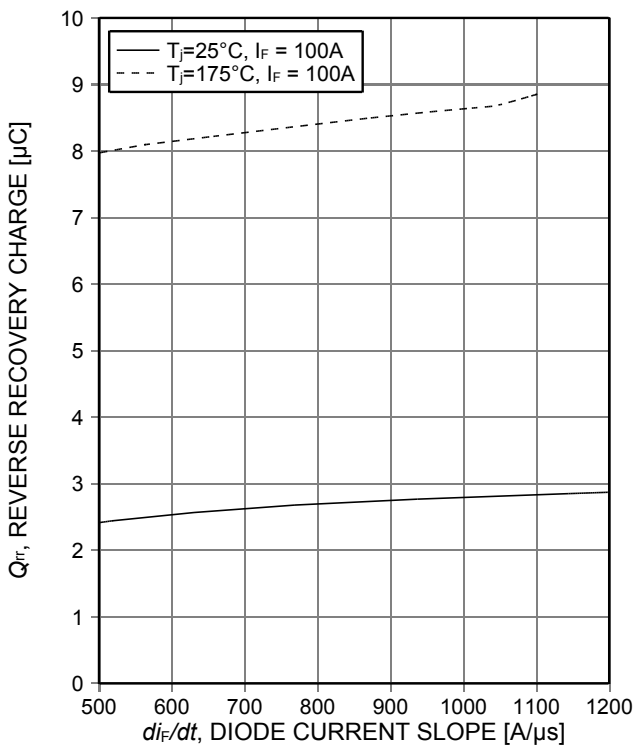

Figure 23. Typical reverse recovery charge as a function of diode current slope ($V_R=400V$, Dynamic test circuit in Figure E)

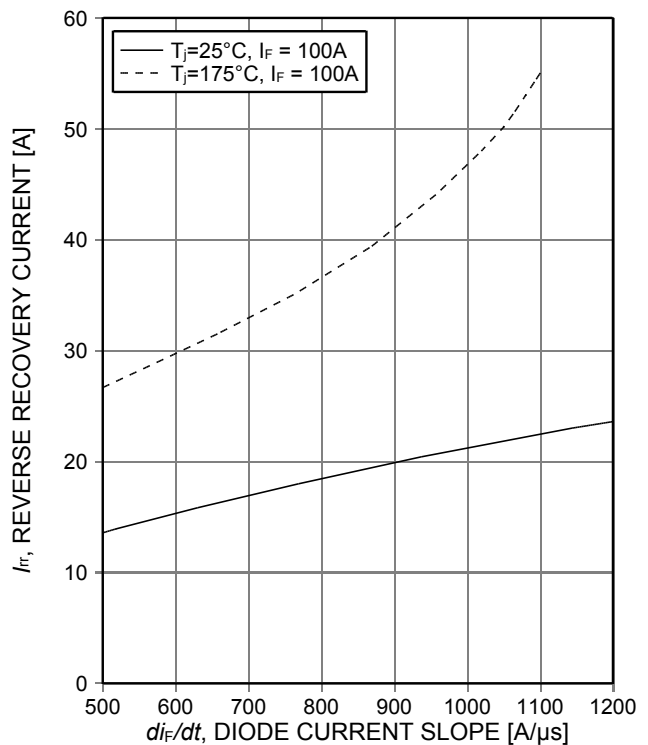

Figure 24. Typical reverse recovery current as a function of diode current slope ($V_R=400V$, Dynamic test circuit in Figure E)

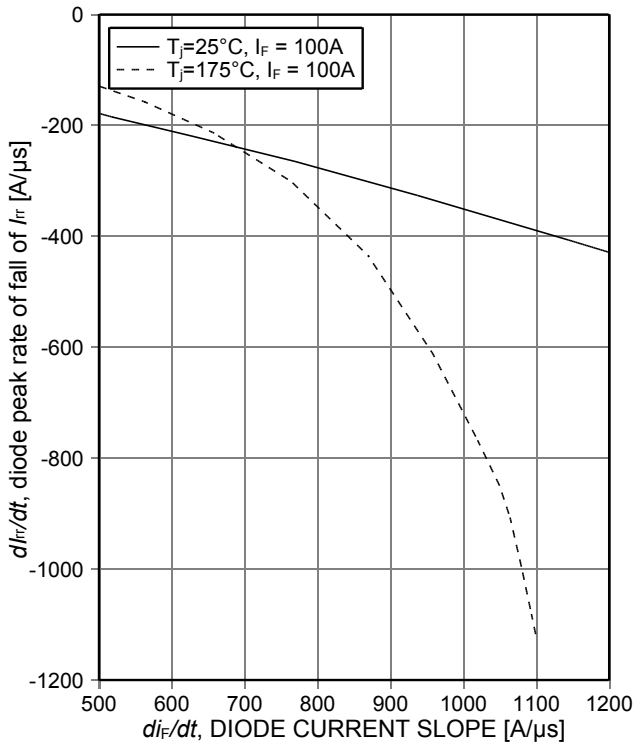

Figure 25. **Typical diode peak rate of fall of reverse recovery current as a function of diode current slope**
($V_R=400V$, Dynamic test circuit in Figure E)

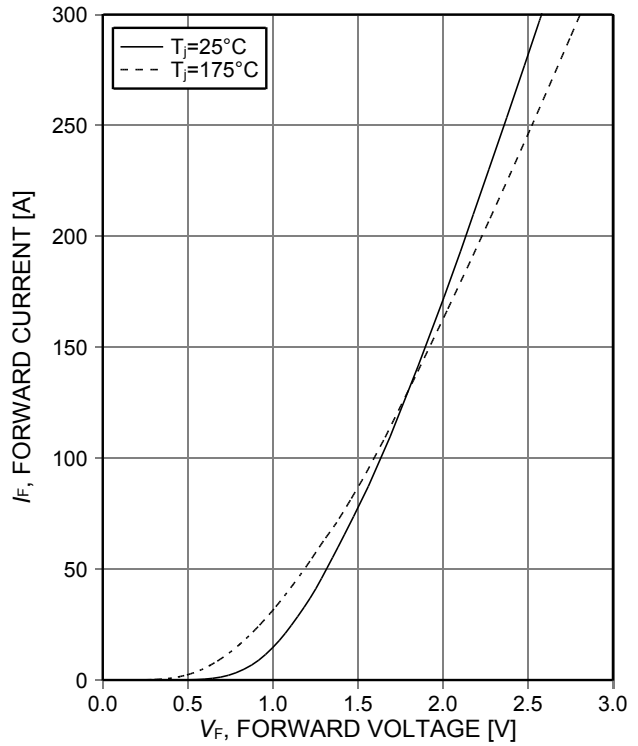

Figure 26. **Typical diode forward current as a function of forward voltage**

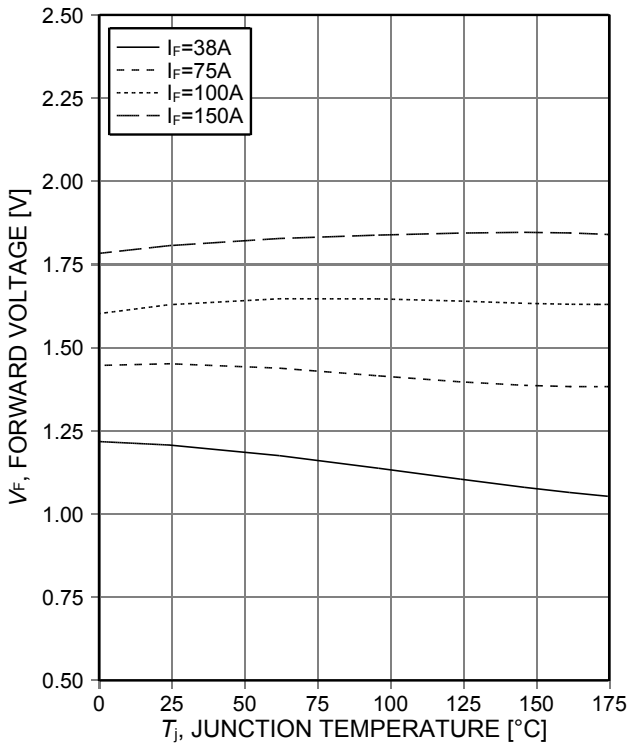
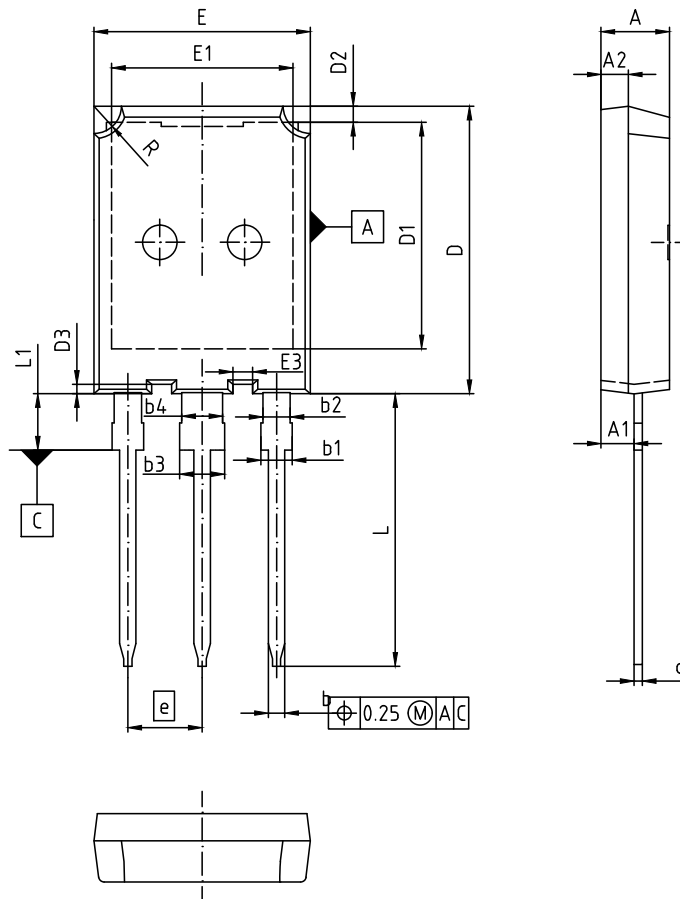

Figure 27. **Typical diode forward voltage as a function of junction temperature**

PG-TO247-3-46



Mold Flash or Protrusions not included

DIM	MILLIMETERS		INCHES	
	MIN	MAX	MIN	MAX
A	4.90	5.10	0.193	0.201
A1	2.31	2.51	0.091	0.099
A2	1.90	2.10	0.075	0.083
b	1.16	1.26	0.046	0.050
b1	1.96	2.25	0.077	0.089
b2	1.96	2.06	0.077	0.081
b3	2.96	3.25	0.117	0.128
b4	2.96	3.06	0.117	0.120
c	0.59	0.66	0.023	0.026
D	20.90	21.10	0.823	0.831
D1	16.25	16.85	0.640	0.663
D2	1.05	1.35	0.041	0.053
D3	0.58	0.78	0.023	0.031
E	15.70	15.90	0.618	0.626
E1	13.10	13.50	0.516	0.531
E3	1.35	1.55	0.053	0.061
e	5.44 (BSC)		0.214 (BSC)	
N	3		3	
L	19.80	20.10	0.780	0.791
L1	-	4.30	-	0.169
R	1.90	2.10	0.075	0.083

DOCUMENT NO.
Z8B00174295

SCALE

EUROPEAN PROJECTION

ISSUE DATE
13-08-2014

REVISION
01

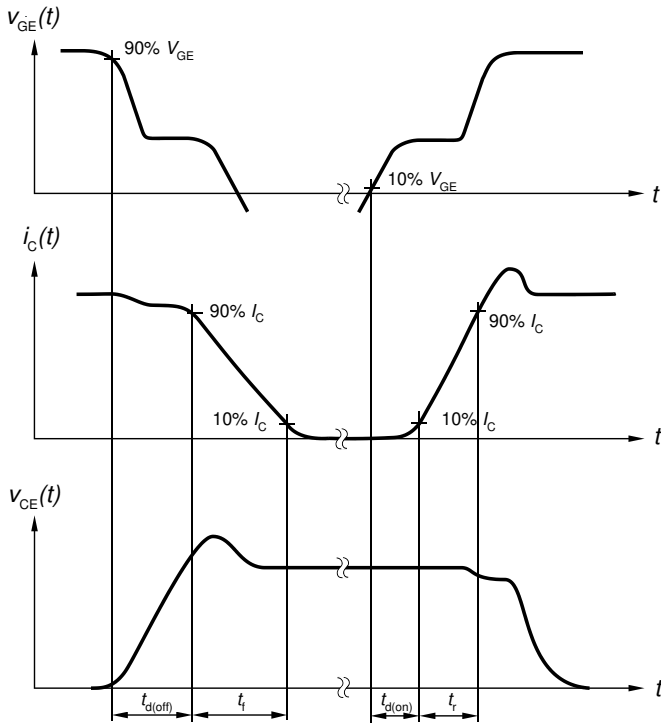

Figure A. Definition of switching times

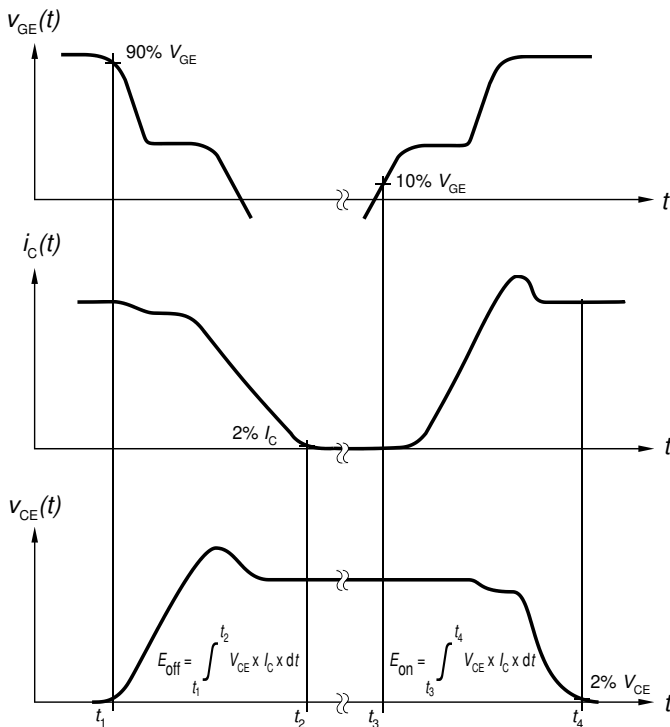

Figure B. Definition of switching losses

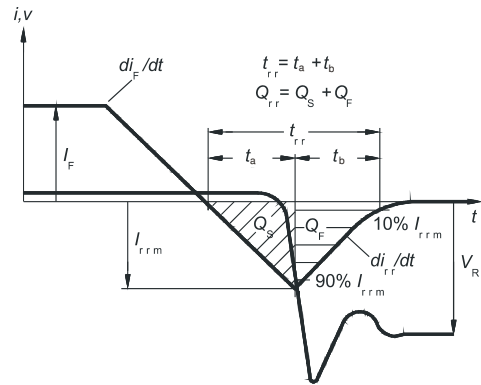

Figure C. Definition of diodes switching characteristics

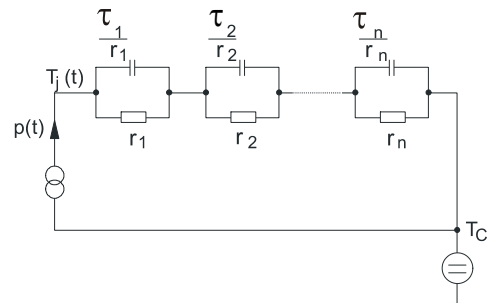

Figure D. Thermal equivalent circuit

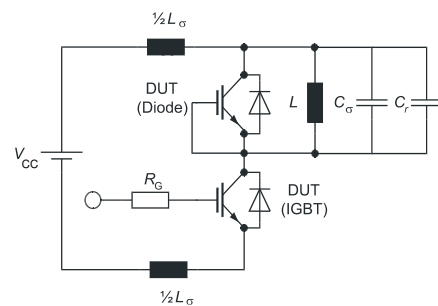

Figure E. Dynamic test circuit
Parasitic inductance L_σ ,
parasitic capacitor C_σ ,
relief capacitor C_r
(only for ZVT switching)

Revision History

IKQ100N60TA

Revision: 2014-11-21, Rev. 2.2

Previous Revision

Revision	Date	Subjects (major changes since last revision)
1.1	2014-07-31	Preliminary data sheet
2.1	2014-10-17	Final data sheet
2.2	2014-11-21	Update of Transconduction gfs

We Listen to Your Comments

Any information within this document that you feel is wrong, unclear or missing at all ?

Your feedback will help us to continuously improve the quality of this document.

Please send your proposal (including a reference to this document) to: erratum@infineon.com

Published by

Infineon Technologies AG

81726 Munich, Germany

81726 München, Germany

© 2014 Infineon Technologies AG

All Rights Reserved.

Legal Disclaimer

The information given in this document shall in no event be regarded as a guarantee of conditions or characteristics.

With respect to any examples or hints given herein, any typical values stated herein and/or any information regarding the application of the device, Infineon Technologies hereby disclaims any and all warranties and liabilities of any kind, including without limitation, warranties of non-infringement of intellectual property rights of any third party.

Information

For further information on technology, delivery terms and conditions and prices, please contact the nearest Infineon Technologies Office (www.infineon.com).

Warnings

Due to technical requirements, components may contain dangerous substances. For information on the types in question, please contact the nearest Infineon Technologies Office.

The Infineon Technologies component described in this Data Sheet may be used in life-support devices or systems and/or automotive, aviation and aerospace applications or systems only with the express written approval of Infineon Technologies, if a failure of such components can reasonably be expected to cause the failure of that life-support, automotive, aviation and aerospace device or system or to affect the safety or effectiveness of that device or system. Life support devices or systems are intended to be implanted in the human body or to support and/or maintain and sustain and/or protect human life. If they fail, it is reasonable to assume that the health of the user or other persons may be endangered.