



Chipsmall Limited consists of a professional team with an average of over 10 year of expertise in the distribution of electronic components. Based in Hongkong, we have already established firm and mutual-benefit business relationships with customers from,Europe,America and south Asia,supplying obsolete and hard-to-find components to meet their specific needs.

With the principle of “Quality Parts,Customers Priority,Honest Operation,and Considerate Service”,our business mainly focus on the distribution of electronic components. Line cards we deal with include Microchip,ALPS,ROHM,Xilinx,Pulse,ON,Everlight and Freescale. Main products comprise IC,Modules,Potentiometer,IC Socket,Relay,Connector.Our parts cover such applications as commercial,industrial, and automotives areas.

We are looking forward to setting up business relationship with you and hope to provide you with the best service and solution. Let us make a better world for our industry!



## Contact us

Tel: +86-755-8981 8866 Fax: +86-755-8427 6832

Email & Skype: info@chipsmall.com Web: www.chipsmall.com

Address: A1208, Overseas Decoration Building, #122 Zhenhua RD., Futian, Shenzhen, China



Sixth generation, high speed soft switching series

High speed soft switching TRENCHSTOP™ IGBT 6 in Trench and Fieldstop technology copacked with soft and fast recovery anti-parallel diode

#### Features:

- 1200V TRENCHSTOP™ IGBT6 technology offering:
- High efficiency in hard switching and resonant topologies
  - Easy paralleling capability due to positive temperature coefficient in  $V_{CEsat}$
  - Low EMI
  - Low Gate Charge  $Q_g$
  - Very soft, fast recovery full current anti-parallel diode
  - Maximum junction temperature 175°C
  - Pb-free lead plating; RoHS compliant
  - Complete product spectrum and PSpice Models:  
<http://www.infineon.com/igbt/>

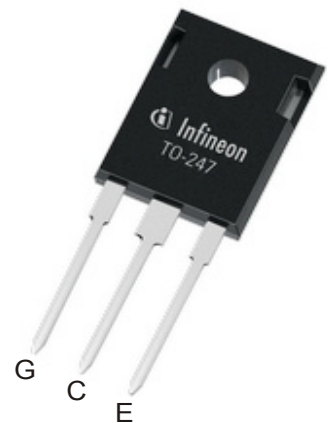
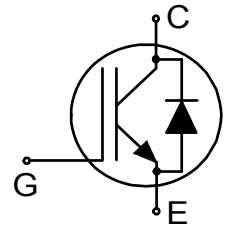

#### Applications:

- Industrial UPS
- Charger
- Energy storage
- Three-level Solar String Inverter
- Welding

#### Product Validation:

Qualified for industrial applications according to the relevant tests of JEDEC47/20/22



#### Key Performance and Package Parameters

| Type         | $V_{CE}$ | $I_C$ | $V_{CEsat}, T_{vj}=25^\circ\text{C}$ | $T_{vjmax}$ | Marking | Package    |
|--------------|----------|-------|--------------------------------------|-------------|---------|------------|
| IKW40N120CS6 | 1200V    | 40A   | 1.85V                                | 175°C       | K40MCS6 | PG-TO247-3 |

---

Sixth generation, high speed soft switching series

## Table of Contents

|   |    |
|---|----|
| Description .....                         | 1  |
| Table of Contents .....                   | 2  |
| Maximum Ratings .....                     | 3  |
| Thermal Resistance .....                  | 3  |
| Electrical Characteristics .....          | 4  |
| Electrical Characteristics Diagrams ..... | 6  |
| Package Drawing .....                     | 13 |
| Testing Conditions .....                  | 14 |
| Revision History .....                    | 15 |
| Disclaimer .....                          | 16 |

## Sixth generation, high speed soft switching series

**Maximum Ratings**

For optimum lifetime and reliability, Infineon recommends operating conditions that do not exceed 80% of the maximum ratings stated in this datasheet.

| Parameter   | Symbol      | Value          | Unit               |
|---|-------------|----------------|--------------------|
| Collector-emitter voltage, $T_{vj} \geq 25^{\circ}\text{C}$   | $V_{CE}$    | 1200           | V                  |
| DC collector current, limited by $T_{vjmax}$<br>$T_c = 25^{\circ}\text{C}$<br>$T_c = 100^{\circ}\text{C}$   | $I_C$       | 80.0<br>40.0   | A                  |
| Pulsed collector current, $t_p$ limited by $T_{vjmax}$  | $I_{Cpuls}$ | 160.0          | A                  |
| Turn off safe operating area $V_{CE} \leq 1200\text{V}$ , $T_{vj} \leq 175^{\circ}\text{C}$   | -           | 160.0          | A                  |
| Diode forward current, limited by $T_{vjmax}$<br>$T_c = 25^{\circ}\text{C}$<br>$T_c = 100^{\circ}\text{C}$  | $I_F$       | 80.0<br>40.0   | A                  |
| Diode pulsed current, $t_p$ limited by $T_{vjmax}$  | $I_{Fpuls}$ | 160.0          | A                  |
| Gate-emitter voltage<br>Transient Gate-emitter voltage ( $t_p \leq 0.5\mu\text{s}$ , $D < 0.001$ )  | $V_{GE}$    | $\pm 20$<br>25 | V                  |
| Short circuit withstand time<br>$V_{GE} = 15.0\text{V}$ , $V_{CC} \leq 500\text{V}$<br>Allowed number of short circuits < 1000<br>Time between short circuits: $\geq 1.0\text{s}$<br>$T_{vj} = 150^{\circ}\text{C}$ | $t_{SC}$    | 3              | $\mu\text{s}$      |
| Power dissipation $T_c = 25^{\circ}\text{C}$<br>Power dissipation $T_c = 100^{\circ}\text{C}$   | $P_{tot}$   | 500.0<br>250.0 | W                  |
| Operating junction temperature  | $T_{vj}$    | -40...+175     | $^{\circ}\text{C}$ |
| Storage temperature   | $T_{stg}$   | -55...+150     | $^{\circ}\text{C}$ |
| Soldering temperature,<br>wave soldering 1.6mm (0.063in.) from case for 10s   |             | 260            | $^{\circ}\text{C}$ |
| Mounting torque, M3 screw<br>Maximum of mounting processes: 3   | $M$         | 0.6            | Nm                 |

**Thermal Resistance**

| Parameter                                    | Symbol        | Conditions | Value |      |      | Unit |
|--|---------------|------------|-------|------|------|------|
|  |               |            | min.  | typ. | max. |      |
| <b><math>R_{th}</math> Characteristics</b>   |               |            |       |      |      |      |
| IGBT thermal resistance,<br>junction - case  | $R_{th(j-c)}$ |            | -     | -    | 0.30 | K/W  |
| Diode thermal resistance,<br>junction - case | $R_{th(j-c)}$ |            | -     | -    | 0.78 | K/W  |
| Thermal resistance<br>junction - ambient     | $R_{th(j-a)}$ |            | -     | -    | 40   | K/W  |



Sixth generation, high speed soft switching series

**Electrical Characteristic, at  $T_{vj} = 25^{\circ}\text{C}$ , unless otherwise specified**

| Parameter                            | Symbol       | Conditions  | Value       |                      |                | Unit          |
|--------------------------------------|--------------|---|-------------|----------------------|----------------|---------------|
|                                      |              |   | min.        | typ.                 | max.           |               |
| <b>Static Characteristic</b>         |              |   |             |                      |                |               |
| Collector-emitter saturation voltage | $V_{CEsat}$  | $V_{GE} = 15.0\text{V}$ , $I_C = 40.0\text{A}$<br>$T_{vj} = 25^{\circ}\text{C}$<br>$T_{vj} = 125^{\circ}\text{C}$<br>$T_{vj} = 175^{\circ}\text{C}$ | -<br>-<br>- | 1.85<br>2.15<br>2.25 | 2.15<br>-<br>- | V             |
| Diode forward voltage                | $V_F$        | $V_{GE} = 0\text{V}$ , $I_F = 40.0\text{A}$<br>$T_{vj} = 25^{\circ}\text{C}$<br>$T_{vj} = 175^{\circ}\text{C}$                                      | -<br>-      | 2.20<br>2.25         | 2.55<br>-      | V             |
| Gate-emitter threshold voltage       | $V_{GE(th)}$ | $I_C = 1.90\text{mA}$ , $V_{CE} = V_{GE}$   | 5.1         | 5.7                  | 6.3            | V             |
| Zero gate voltage collector current  | $I_{CES}$    | $V_{CE} = 1200\text{V}$ , $V_{GE} = 0\text{V}$<br>$T_{vj} = 25^{\circ}\text{C}$<br>$T_{vj} = 175^{\circ}\text{C}$                                   | -<br>-      | -<br>1600            | 850<br>-       | $\mu\text{A}$ |
| Gate-emitter leakage current         | $I_{GES}$    | $V_{CE} = 0\text{V}$ , $V_{GE} = 20\text{V}$  | -           | -                    | 600            | nA            |
| Transconductance                     | $g_{fs}$     | $V_{CE} = 20\text{V}$ , $I_C = 40.0\text{A}$  | -           | 32.0                 | -              | S             |

**Electrical Characteristic, at  $T_{vj} = 25^{\circ}\text{C}$ , unless otherwise specified**

| Parameter  | Symbol    | Conditions   | Value |       |      | Unit |
|--|-----------|--|-------|-------|------|------|
|  |           |  | min.  | typ.  | max. |      |
| <b>Dynamic Characteristic</b>  |           |  |       |       |      |      |
| Input capacitance  | $C_{ies}$ | $V_{CE} = 25\text{V}$ , $V_{GE} = 0\text{V}$ , $f = 1\text{MHz}$         | -     | 2700  | -    | pF   |
| Output capacitance   | $C_{oes}$ |  | -     | 185   | -    |      |
| Reverse transfer capacitance   | $C_{res}$ |  | -     | 120   | -    |      |
| Gate charge  | $Q_G$     | $V_{CC} = 960\text{V}$ , $I_C = 40.0\text{A}$ ,<br>$V_{GE} = 15\text{V}$ | -     | 285.0 | -    | nC   |
| Internal emitter inductance<br>measured 5mm (0.197 in.) from<br>case | $L_E$     |  | -     | 13.0  | -    | nH   |

**Switching Characteristic, Inductive Load**

| Parameter | Symbol | Conditions | Value |      |      | Unit |
|-----------|--------|------------|-------|------|------|------|
|           |        |            | min.  | typ. | max. |      |

**IGBT Characteristic, at  $T_{vj} = 25^{\circ}\text{C}$** 

|                        |              |  |   |      |   |    |
|------------------------|--------------|--|---|------|---|----|
| Turn-on delay time     | $t_{d(on)}$  | $T_{vj} = 25^{\circ}\text{C}$ ,<br>$V_{CC} = 600\text{V}$ , $I_C = 40.0\text{A}$ ,<br>$V_{GE} = 0.0/15.0\text{V}$ ,<br>$R_{G(on)} = 9.0\Omega$ , $R_{G(off)} = 9.0\Omega$ ,<br>$L_{\sigma} = 70\text{nH}$ , $C_{\sigma} = 67\text{pF}$<br>$L_{\sigma}$ , $C_{\sigma}$ from Fig. E<br>Energy losses include "tail" and<br>diode reverse recovery. | - | 27   | - | ns |
| Rise time              | $t_r$        |  | - | 39   | - | ns |
| Turn-off delay time    | $t_{d(off)}$ |  | - | 315  | - | ns |
| Fall time              | $t_f$        |  | - | 27   | - | ns |
| Turn-on energy         | $E_{on}$     |  | - | 2.55 | - | mJ |
| Turn-off energy        | $E_{off}$    |  | - | 1.55 | - | mJ |
| Total switching energy | $E_{ts}$     |  | - | 4.10 | - | mJ |

Sixth generation, high speed soft switching series

#### Diode Characteristic, at $T_{vj} = 25^{\circ}\text{C}$

|  |              |   |   |      |   |                        |
|--|--------------|---|---|------|---|------------------------|
| Diode reverse recovery time                                      | $t_{rr}$     | $T_{vj} = 25^{\circ}\text{C}$ ,<br>$V_R = 600\text{V}$ ,<br>$I_F = 40.0\text{A}$ ,<br>$di_F/dt = 700\text{A}/\mu\text{s}$ ,<br>$L\sigma = 70\text{nH}$ ,<br>$C\sigma = 67\text{pF}$ | - | 400  | - | ns                     |
| Diode reverse recovery charge                                    | $Q_{rr}$     |   | - | 2.65 | - | $\mu\text{C}$          |
| Diode peak reverse recovery current                              | $I_{rrm}$    |   | - | 18.0 | - | A                      |
| Diode peak rate of fall of reverse recovery current during $t_b$ | $di_{rr}/dt$ |   | - | -65  | - | $\text{A}/\mu\text{s}$ |

#### Switching Characteristic, Inductive Load

| Parameter | Symbol | Conditions | Value |      |      | Unit |
|-----------|--------|------------|-------|------|------|------|
|           |        |            | min.  | typ. | max. |      |

#### IGBT Characteristic, at $T_{vj} = 175^{\circ}\text{C}$

|                        |              |  |   |      |   |    |
|------------------------|--------------|--|---|------|---|----|
| Turn-on delay time     | $t_{d(on)}$  | $T_{vj} = 175^{\circ}\text{C}$ ,<br>$V_{CC} = 600\text{V}$ , $I_C = 40.0\text{A}$ ,<br>$V_{GE} = 0.0/15.0\text{V}$ ,<br>$R_{G(on)} = 9.0\Omega$ , $R_{G(off)} = 9.0\Omega$ ,<br>$L\sigma = 70\text{nH}$ , $C\sigma = 67\text{pF}$<br>$L\sigma$ , $C\sigma$ from Fig. E<br>Energy losses include "tail" and diode reverse recovery. | - | 27   | - | ns |
| Rise time              | $t_r$        |  | - | 38   | - | ns |
| Turn-off delay time    | $t_{d(off)}$ |  | - | 390  | - | ns |
| Fall time              | $t_f$        |  | - | 55   | - | ns |
| Turn-on energy         | $E_{on}$     |  | - | 3.50 | - | mJ |
| Turn-off energy        | $E_{off}$    |  | - | 2.95 | - | mJ |
| Total switching energy | $E_{ts}$     |  | - | 6.45 | - | mJ |

#### Diode Characteristic, at $T_{vj} = 175^{\circ}\text{C}$

|  |              |  |   |      |   |                        |
|--|--------------|--|---|------|---|------------------------|
| Diode reverse recovery time                                      | $t_{rr}$     | $T_{vj} = 175^{\circ}\text{C}$ ,<br>$V_R = 600\text{V}$ ,<br>$I_F = 40.0\text{A}$ ,<br>$di_F/dt = 800\text{A}/\mu\text{s}$ ,<br>$L\sigma = 70\text{nH}$ ,<br>$C\sigma = 67\text{pF}$ | - | 720  | - | ns                     |
| Diode reverse recovery charge                                    | $Q_{rr}$     |  | - | 6.40 | - | $\mu\text{C}$          |
| Diode peak reverse recovery current                              | $I_{rrm}$    |  | - | 27.0 | - | A                      |
| Diode peak rate of fall of reverse recovery current during $t_b$ | $di_{rr}/dt$ |  | - | -70  | - | $\text{A}/\mu\text{s}$ |

Sixth generation, high speed soft switching series

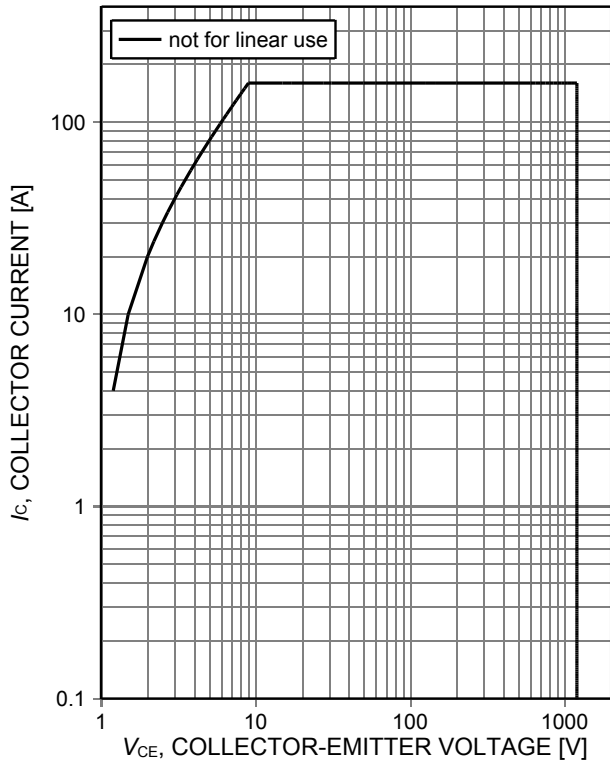

Figure 1. **Forward bias safe operating area**  
 ( $D=0$ ,  $T_{vj} \leq 175^{\circ}\text{C}$ ;  $V_{GE}=15\text{V}$ , pulse width limited by  $T_{vjmax}$ )

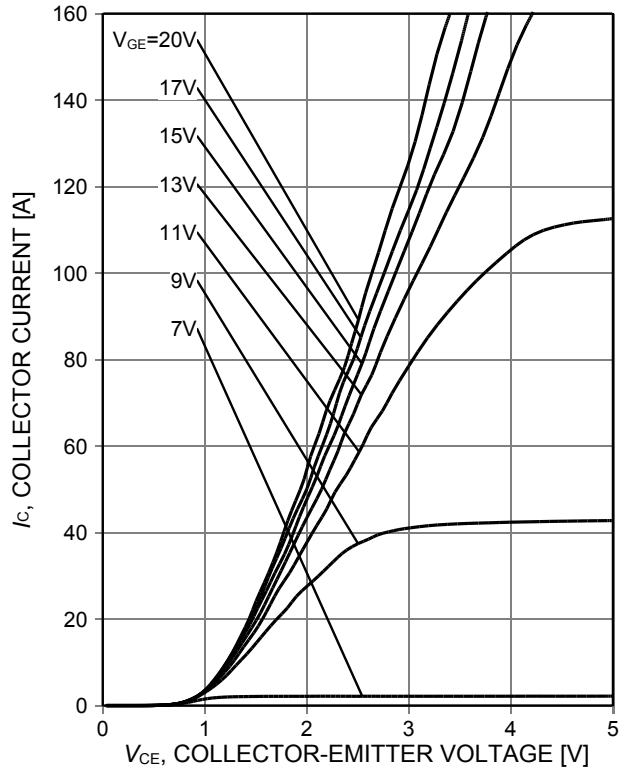

Figure 2. **Typical output characteristic**  
 ( $T_{vj}=25^{\circ}\text{C}$ )

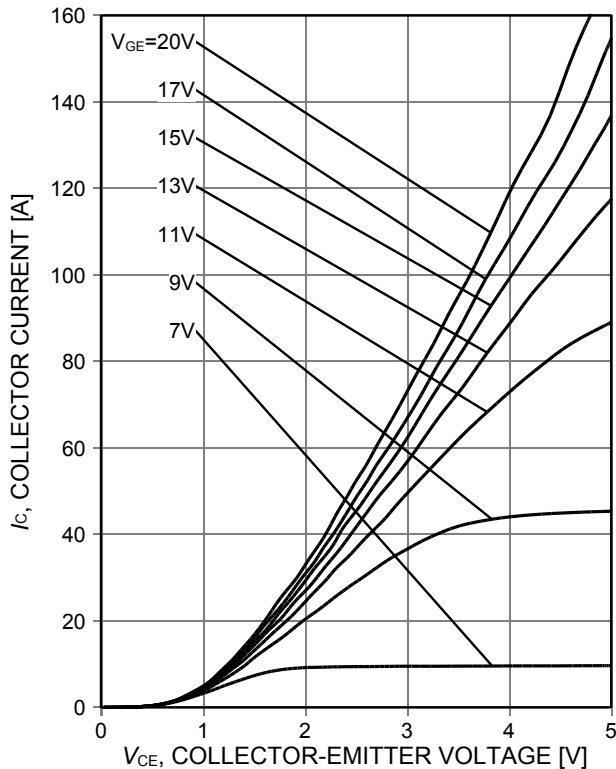

Figure 3. **Typical output characteristic**  
 ( $T_{vj}=175^{\circ}\text{C}$ )

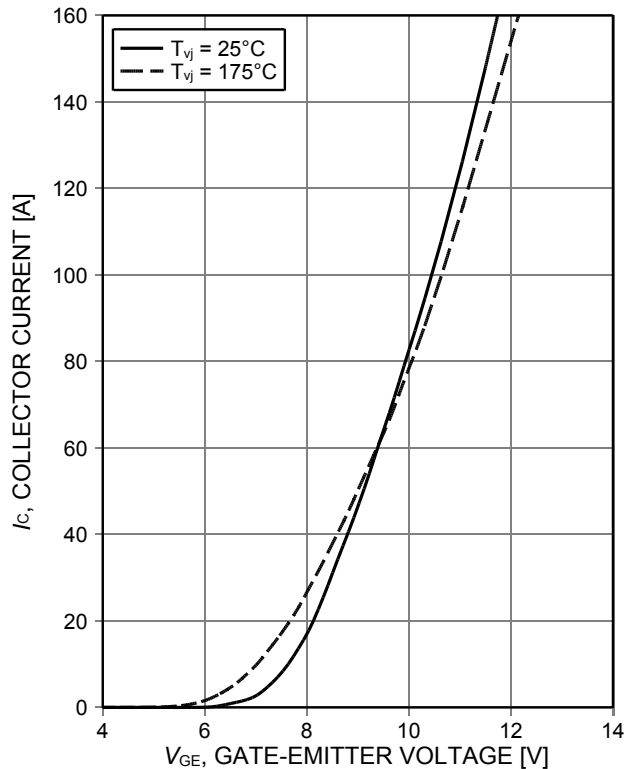

Figure 4. **Typical transfer characteristic**  
 ( $V_{CE}=20\text{V}$ )

Sixth generation, high speed soft switching series

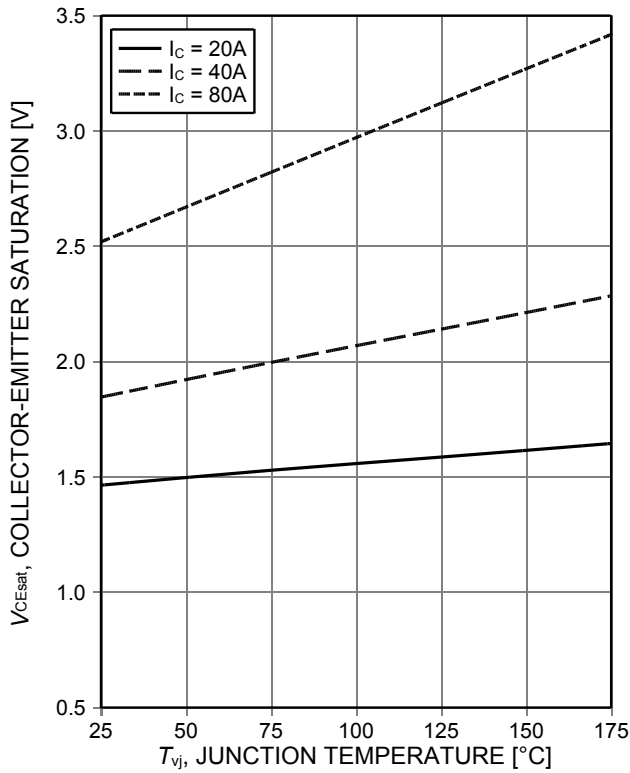

Figure 5. **Typical collector-emitter saturation voltage as a function of junction temperature** ( $V_{GE}=15V$ )

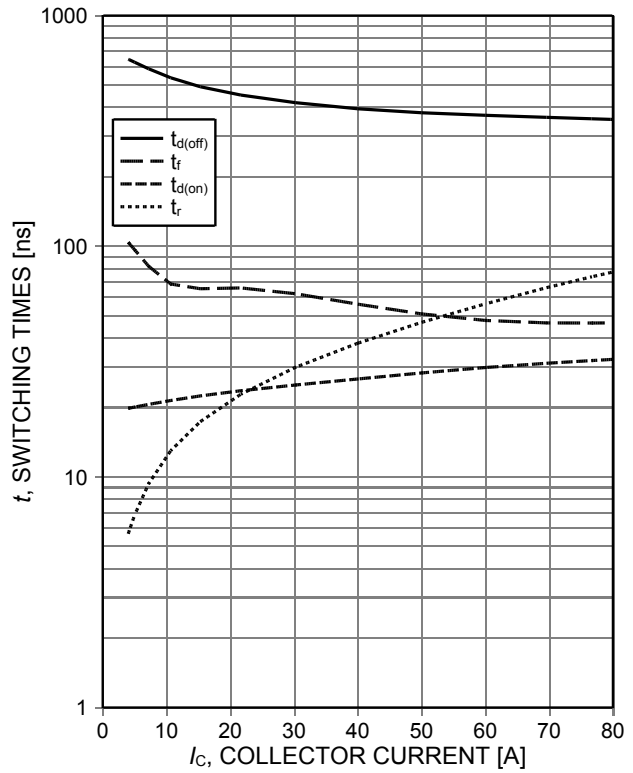

Figure 6. **Typical switching times as a function of collector current** (inductive load,  $T_{vj}=175^{\circ}C$ ,  $V_{CE}=600V$ ,  $V_{GE}=0/15V$ ,  $R_G=9\Omega$ , Dynamic test circuit in Figure E)

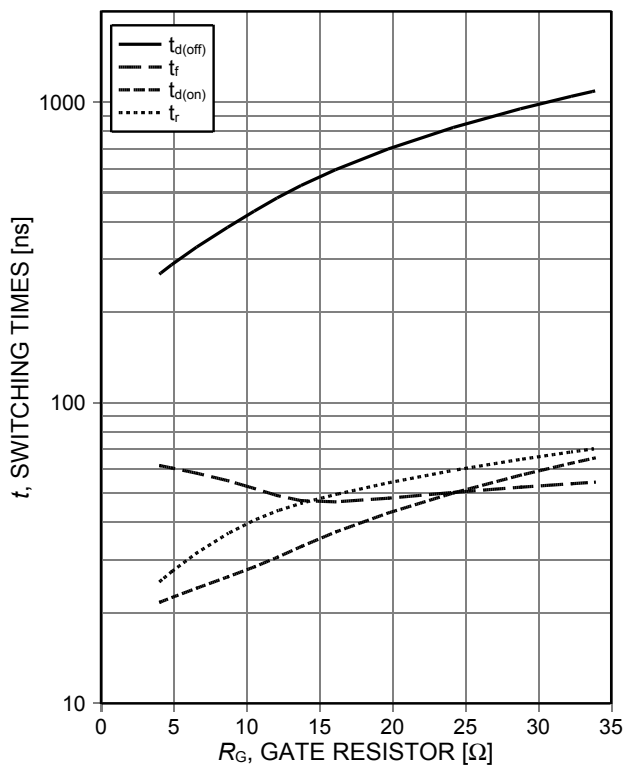

Figure 7. **Typical switching times as a function of gate resistor** (inductive load,  $T_{vj}=175^{\circ}C$ ,  $V_{CE}=600V$ ,  $V_{GE}=0/15V$ ,  $I_C=40A$ , Dynamic test circuit in Figure E)

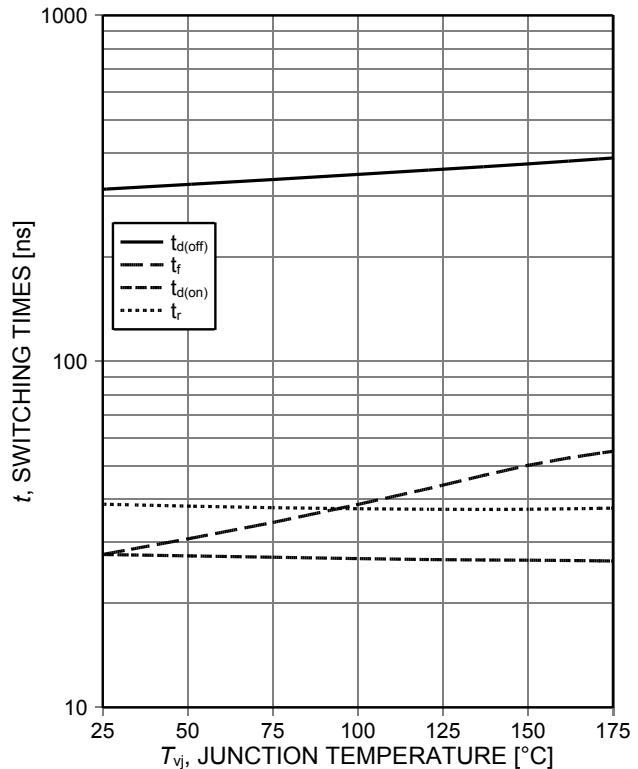

Figure 8. **Typical switching times as a function of junction temperature** (inductive load,  $V_{CE}=600V$ ,  $V_{GE}=0/15V$ ,  $I_C=40A$ ,  $R_G=9\Omega$ , Dynamic test circuit in Figure E)



Sixth generation, high speed soft switching series

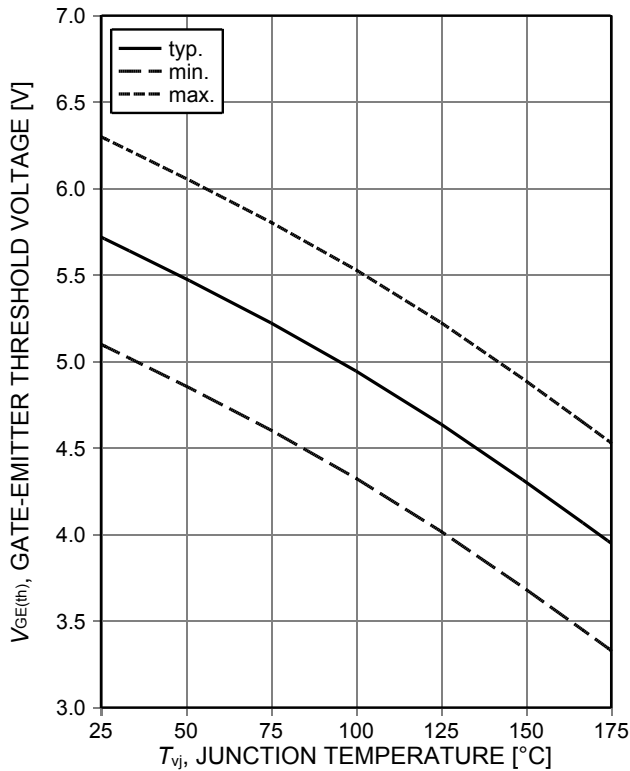

Figure 9. Gate-emitter threshold voltage as a function of junction temperature ( $I_C=1.9\text{mA}$ )

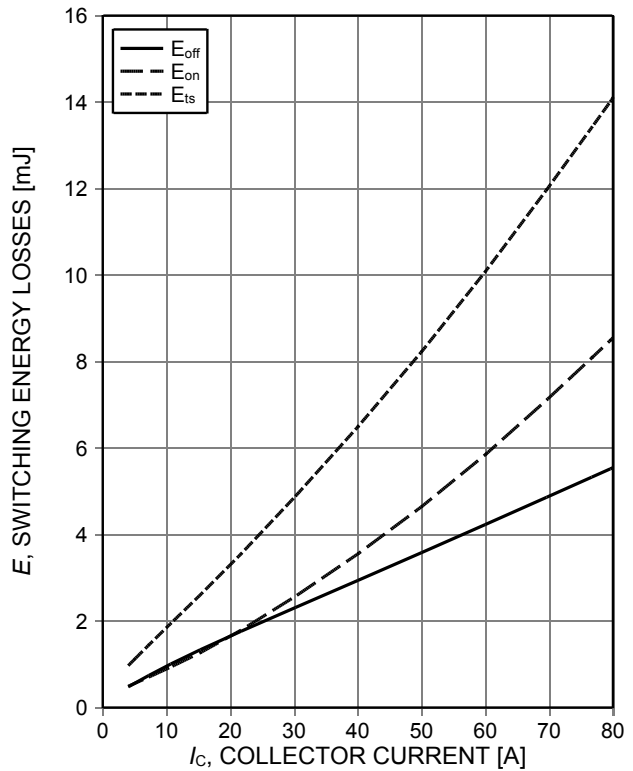

Figure 10. Typical switching energy losses as a function of collector current (inductive load,  $T_{vj}=175^\circ\text{C}$ ,  $V_{CE}=600\text{V}$ ,  $V_{GE}=0/15\text{V}$ ,  $R_G=9\Omega$ , Dynamic test circuit in Figure E)

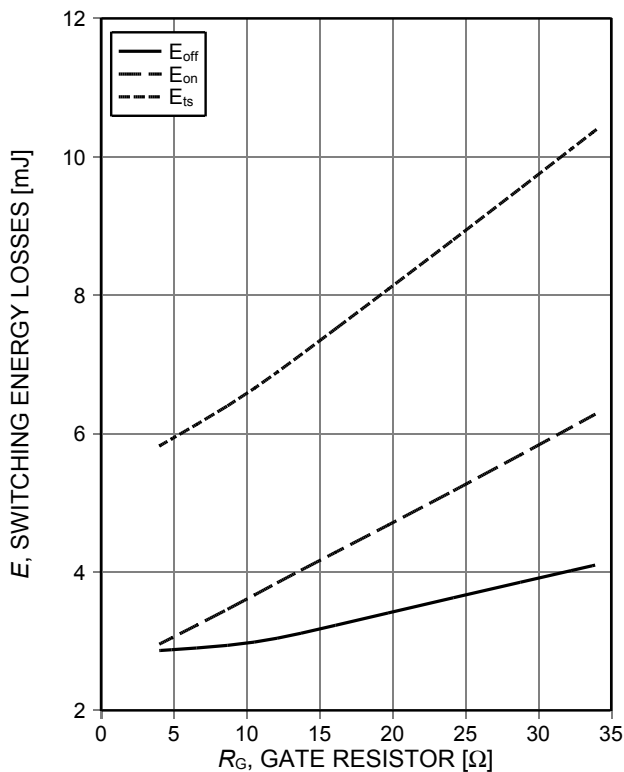

Figure 11. Typical switching energy losses as a function of gate resistor (inductive load,  $T_{vj}=175^\circ\text{C}$ ,  $V_{CE}=600\text{V}$ ,  $V_{GE}=0/15\text{V}$ ,  $I_C=40\text{A}$ , Dynamic test circuit in Figure E)

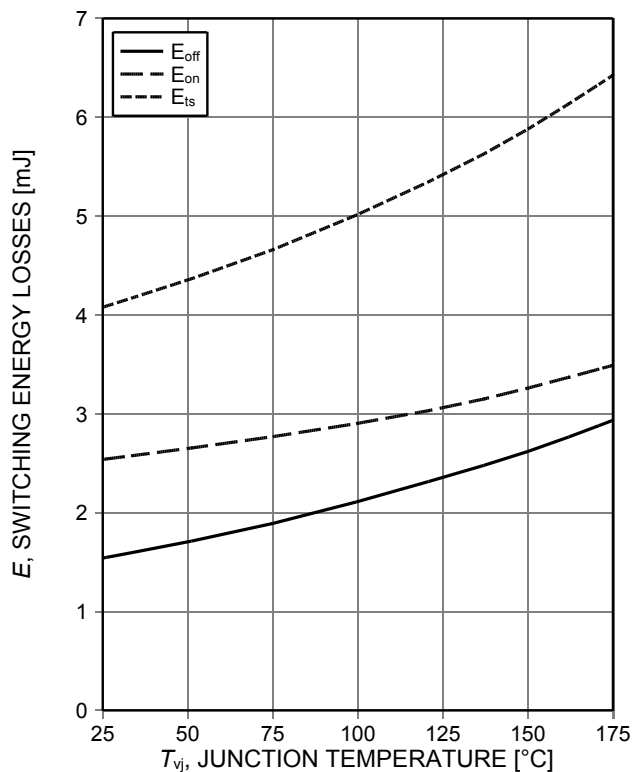

Figure 12. Typical switching energy losses as a function of junction temperature (inductive load,  $V_{CE}=600\text{V}$ ,  $V_{GE}=0/15\text{V}$ ,  $I_C=40\text{A}$ ,  $R_G=9\Omega$ , Dynamic test circuit in Figure E)

Sixth generation, high speed soft switching series

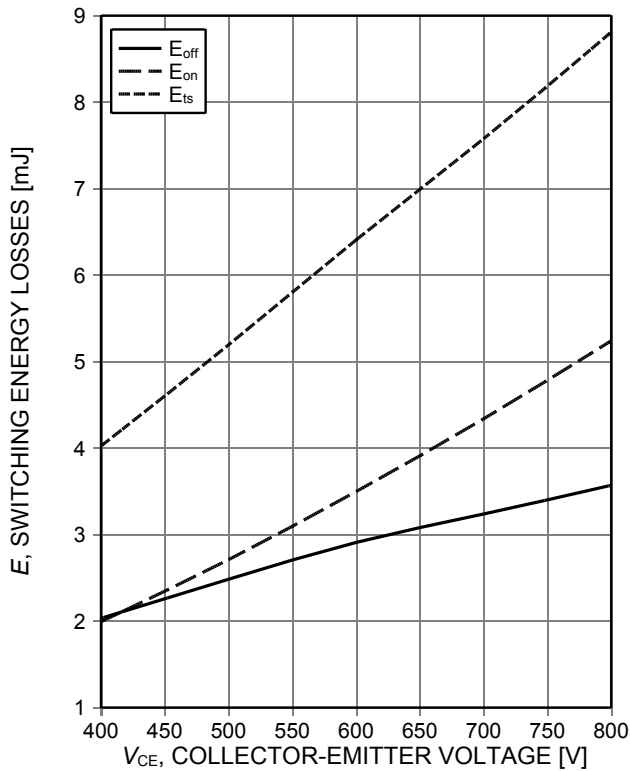

Figure 13. **Typical switching energy losses as a function of collector emitter voltage** (inductive load,  $T_{vj}=175^{\circ}\text{C}$ ,  $V_{GE}=0/15\text{V}$ ,  $I_C=40\text{A}$ ,  $R_G=9\Omega$ , Dynamic test circuit in Figure E)

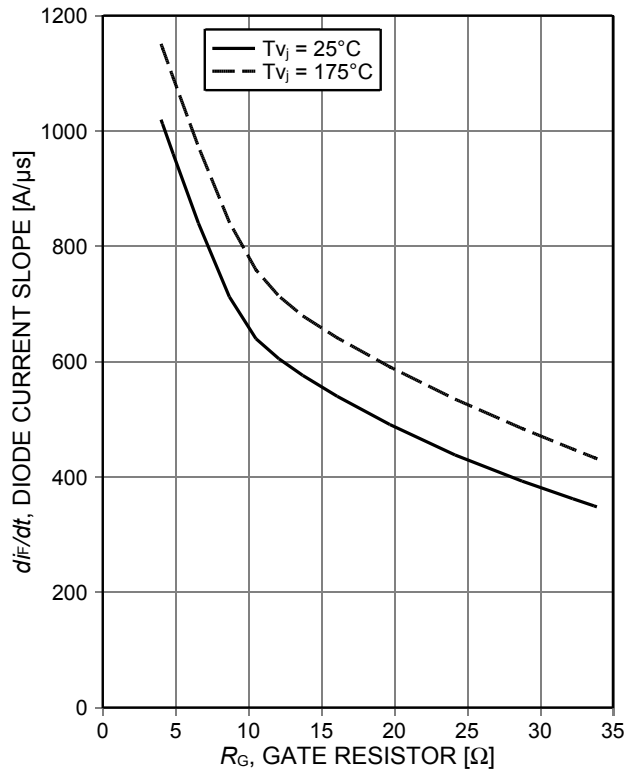

Figure 14. **Typical diode current slope as a function of gate resistor** (inductive load,  $V_{CE}=600\text{V}$ ,  $V_{GE}=0/15\text{V}$ ,  $I_C=40\text{A}$ , Dynamic test circuit in Figure E)

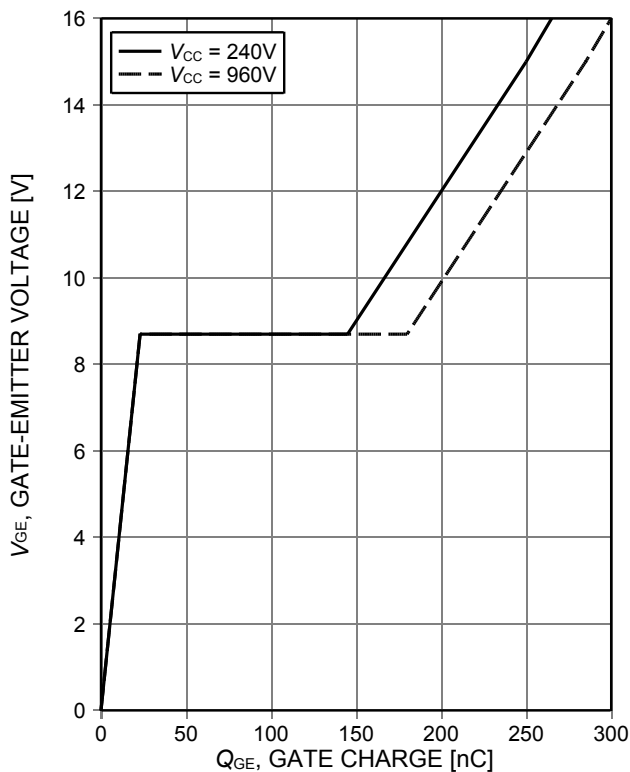

Figure 15. **Typical gate charge** ( $I_C=40\text{A}$ )

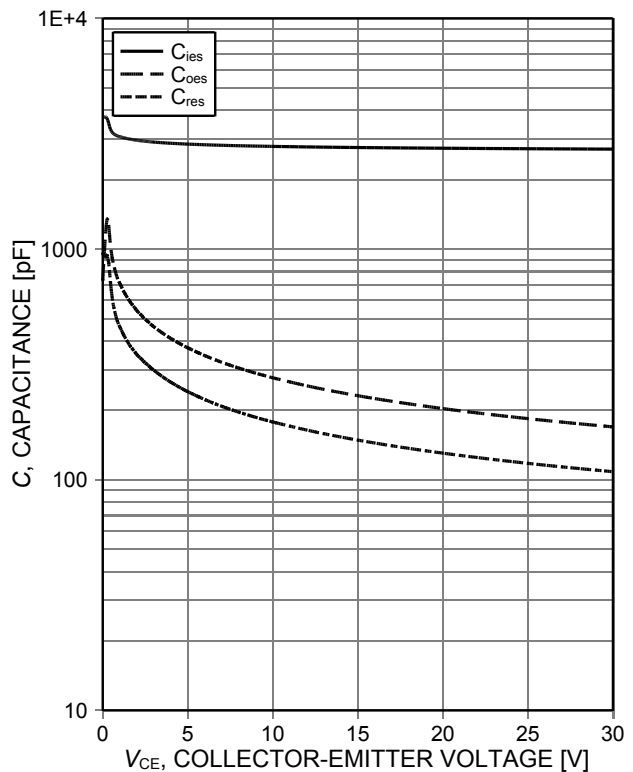

Figure 16. **Typical capacitance as a function of collector-emitter voltage** ( $V_{GE}=0\text{V}$ ,  $f=1\text{MHz}$ )

Sixth generation, high speed soft switching series

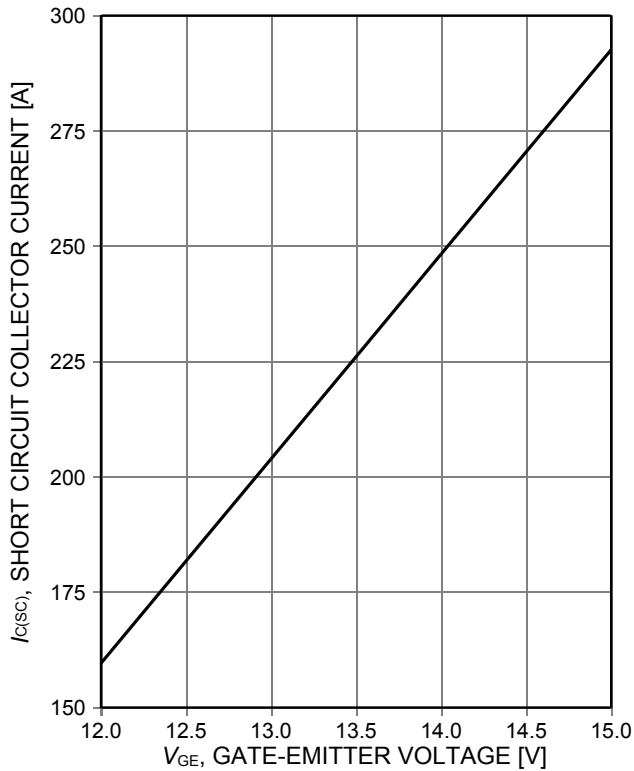

Figure 17. Typical short circuit collector current as a function of gate-emitter voltage ( $V_{CE} \leq 500V$ ,  $T_{vj} \leq 175^\circ C$ )

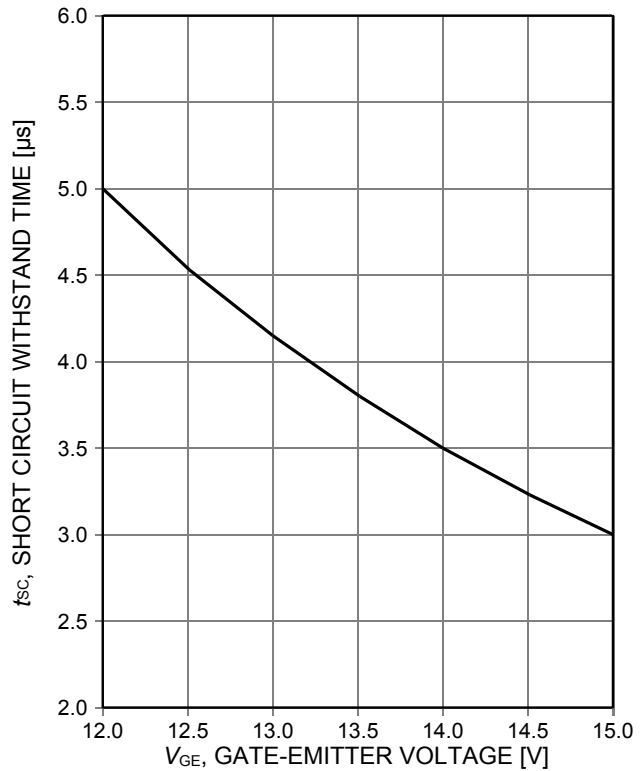

Figure 18. Short circuit withstand time as a function of gate-emitter voltage ( $V_{CE} \leq 500V$ , start at  $T_{vj} \leq 175^\circ C$ )

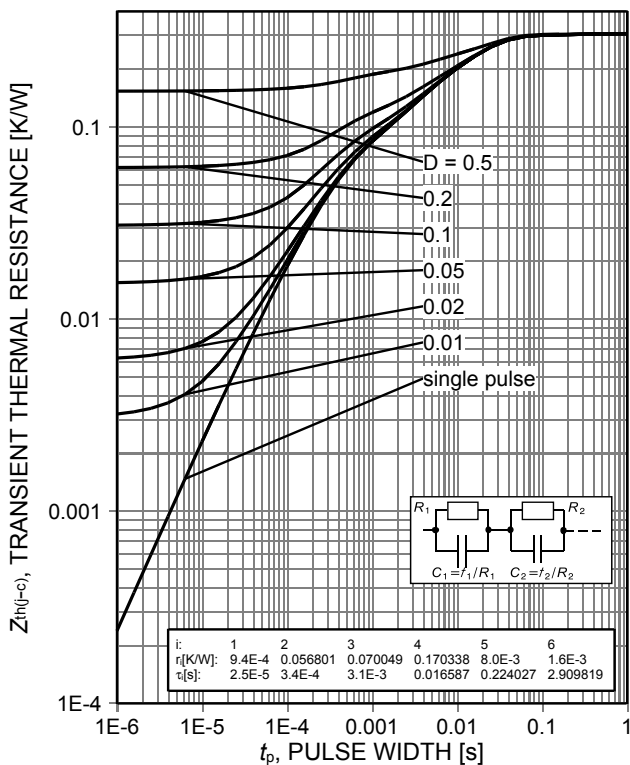

Figure 19. IGBT transient thermal resistance ( $D = t_p/T$ )

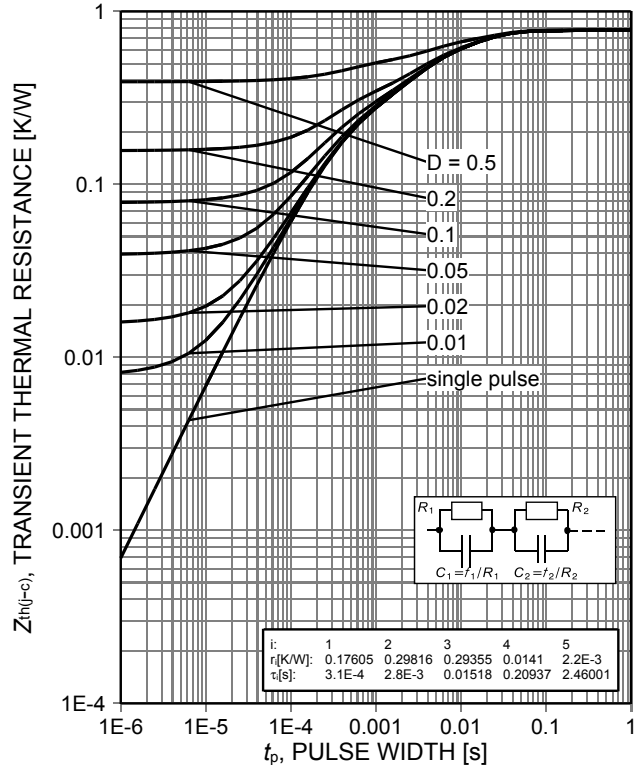

Figure 20. Diode transient thermal impedance as a function of pulse width ( $D = t_p/T$ )

Sixth generation, high speed soft switching series

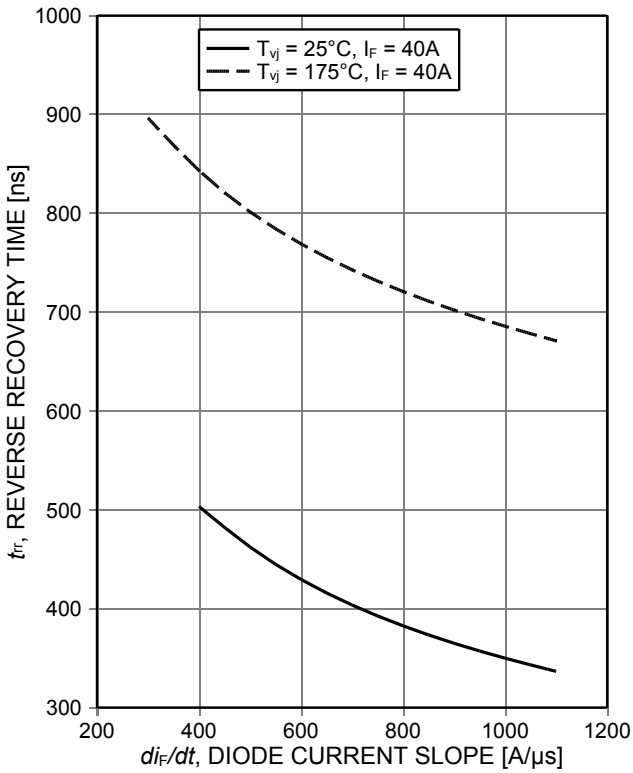

Figure 21. Typical reverse recovery time as a function of diode current slope (VR=600V)

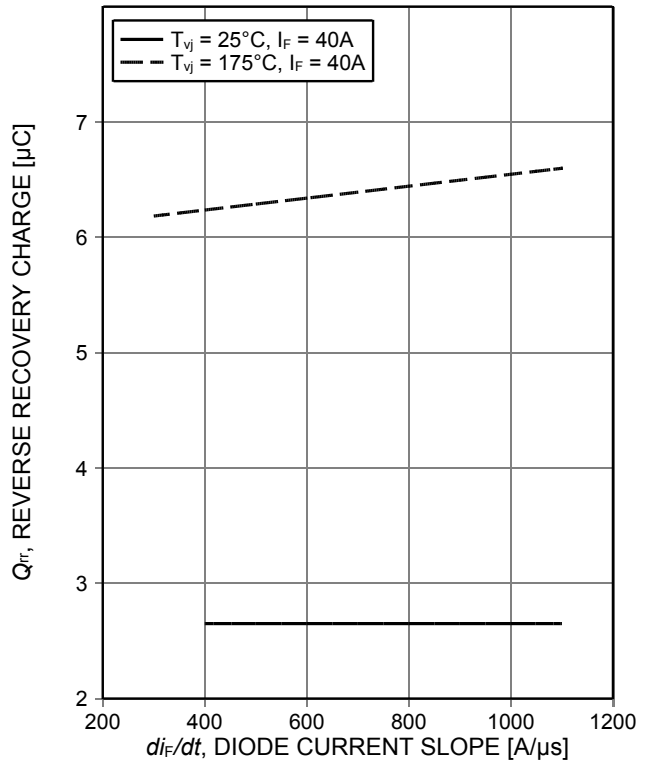

Figure 22. Typical reverse recovery charge as a function of diode current slope (VR=600V)

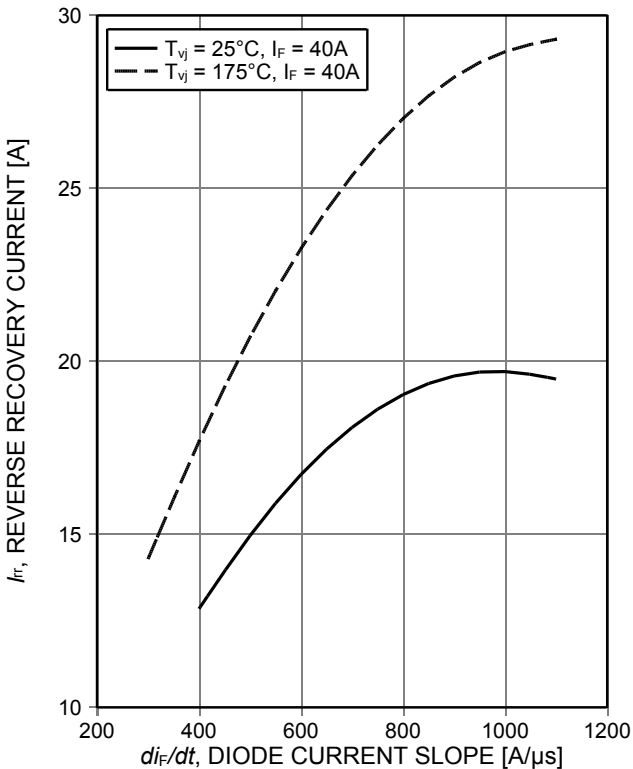

Figure 23. Typical reverse recovery current as a function of diode current slope (VR=600V)

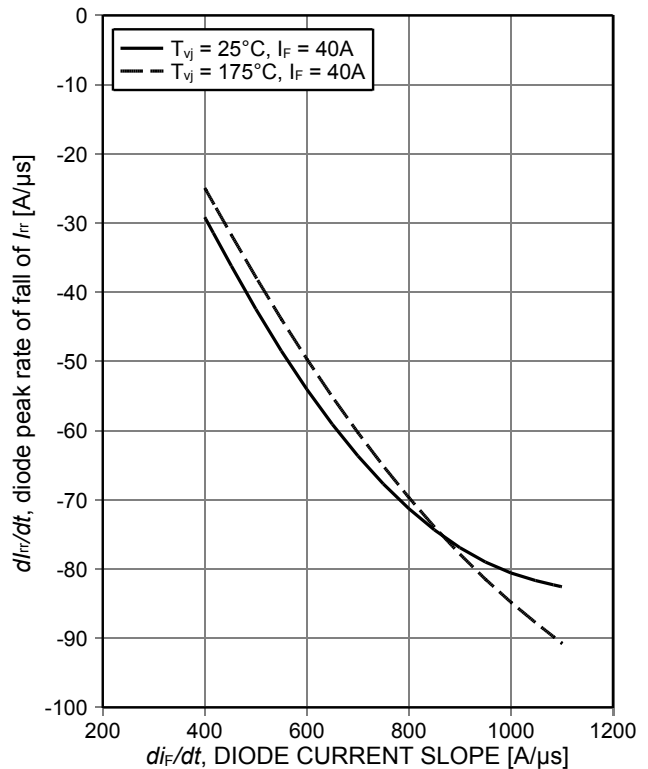

Figure 24. Typical diode peak rate of fall of reverse recovery current as a function of diode current slope (VR=600V)

Sixth generation, high speed soft switching series

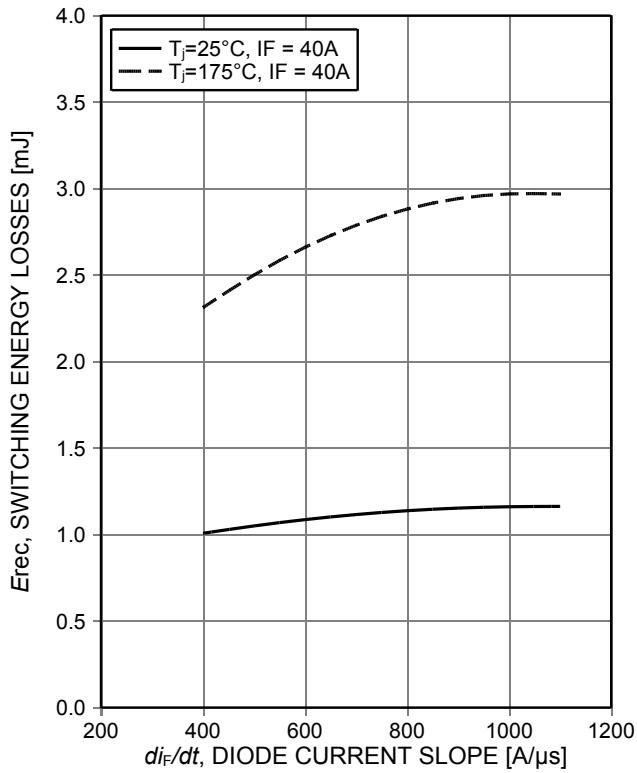

Figure 25. **Typical reverse energy losses as a function of diode current slope** ( $V_R=600V$ )

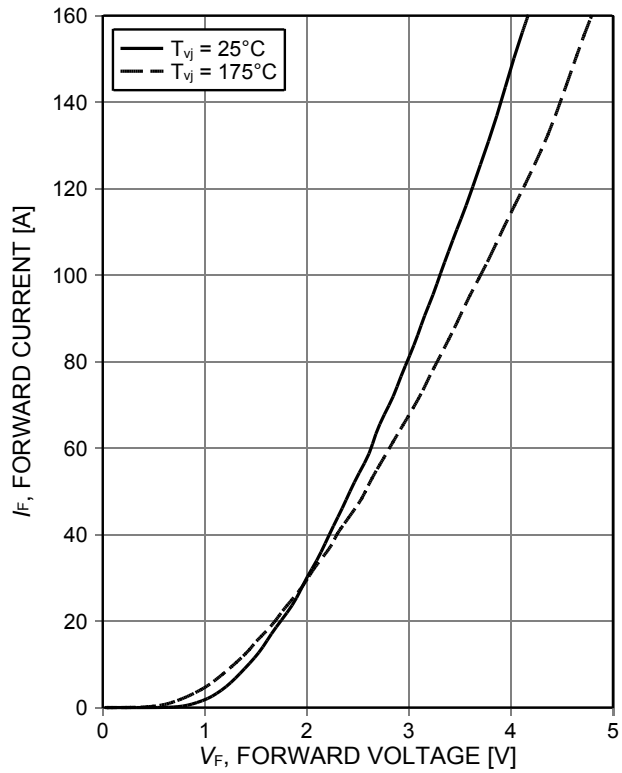

Figure 26. **Typical diode forward current as a function of forward voltage**

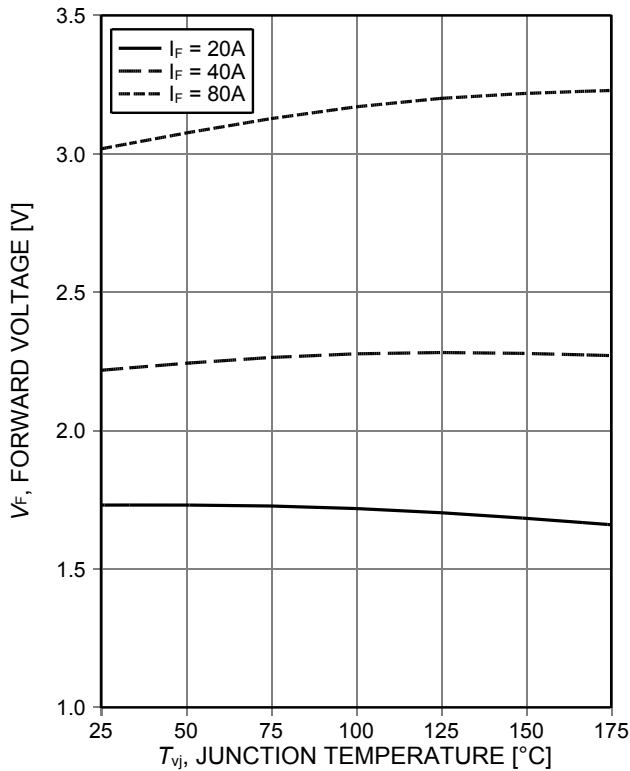
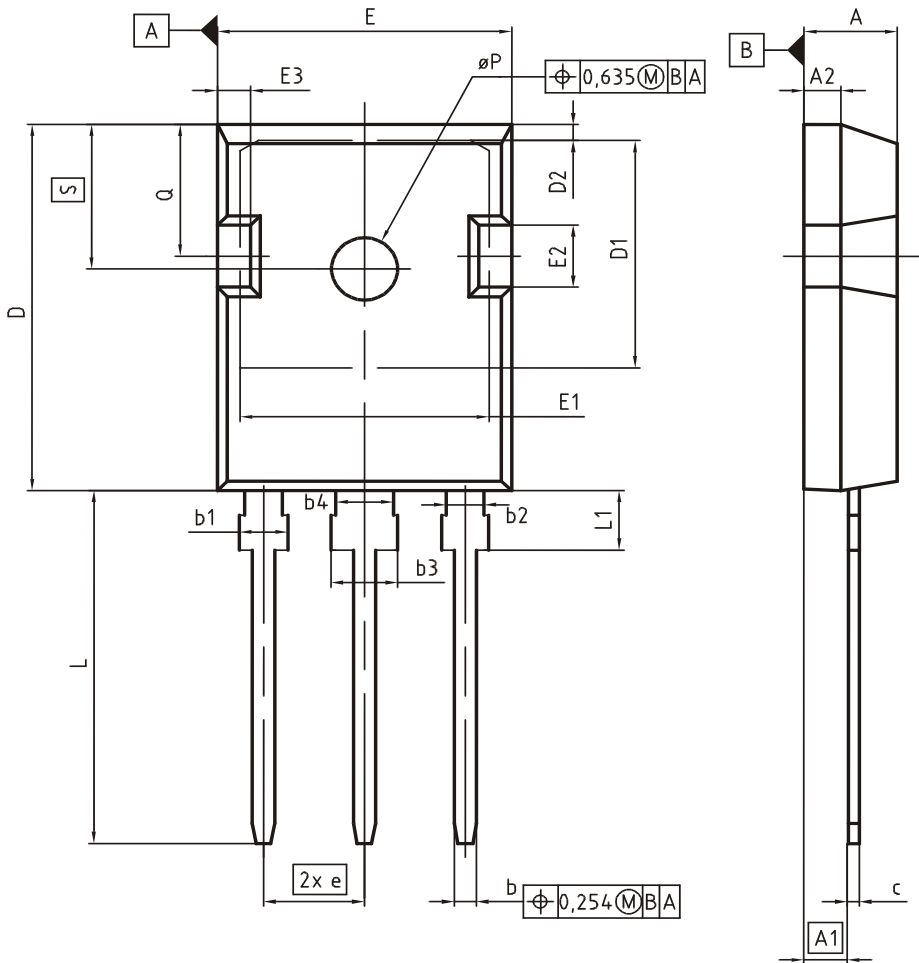

Figure 27. **Typical diode forward voltage as a function of junction temperature**

Sixth generation, high speed soft switching series

Package Drawing PG-TO247-3



| DIM | MILLIMETERS |       | INCHES      |       |
|-----|-------------|-------|-------------|-------|
|     | MIN         | MAX   | MIN         | MAX   |
| A   | 4.83        | 5.21  | 0.190       | 0.205 |
| A1  | 2.27        | 2.54  | 0.089       | 0.100 |
| A2  | 1.85        | 2.16  | 0.073       | 0.085 |
| b   | 1.07        | 1.33  | 0.042       | 0.052 |
| b1  | 1.90        | 2.41  | 0.075       | 0.095 |
| b2  | 1.90        | 2.16  | 0.075       | 0.085 |
| b3  | 2.87        | 3.38  | 0.113       | 0.133 |
| b4  | 2.87        | 3.13  | 0.113       | 0.123 |
| c   | 0.55        | 0.68  | 0.022       | 0.027 |
| D   | 20.80       | 21.10 | 0.819       | 0.831 |
| D1  | 16.25       | 17.65 | 0.640       | 0.695 |
| D2  | 0.95        | 1.35  | 0.037       | 0.053 |
| E   | 15.70       | 16.13 | 0.618       | 0.635 |
| E1  | 13.10       | 14.15 | 0.516       | 0.557 |
| E2  | 3.68        | 5.10  | 0.145       | 0.201 |
| E3  | 1.00        | 2.60  | 0.039       | 0.102 |
| e   | 5.44 (BSC)  |       | 0.214 (BSC) |       |
| N   | 3           |       | 3           |       |
| L   | 19.80       | 20.32 | 0.780       | 0.800 |
| L1  | 4.10        | 4.47  | 0.161       | 0.176 |
| øP  | 3.50        | 3.70  | 0.138       | 0.146 |
| Q   | 5.49        | 6.00  | 0.216       | 0.236 |
| S   | 6.04        | 6.30  | 0.238       | 0.248 |

DOCUMENT NO.  
Z8B00003327

SCALE

EUROPEAN PROJECTION

ISSUE DATE  
09-07-2010

REVISION  
05



Testing Conditions

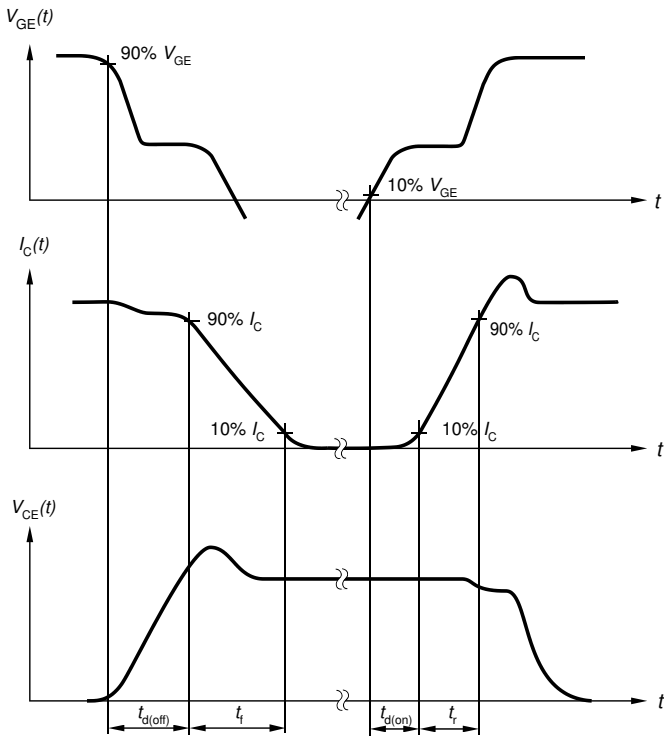

Figure A. Definition of switching times

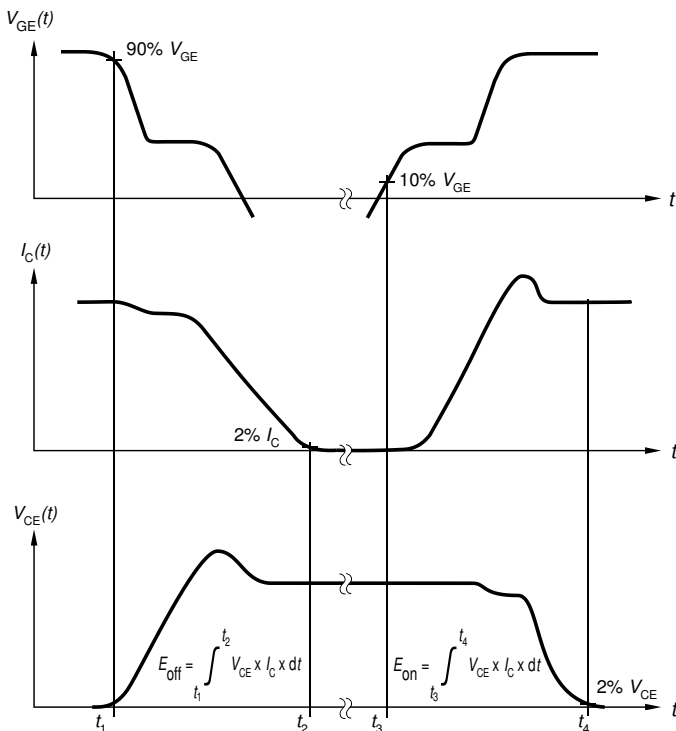

Figure B. Definition of switching losses

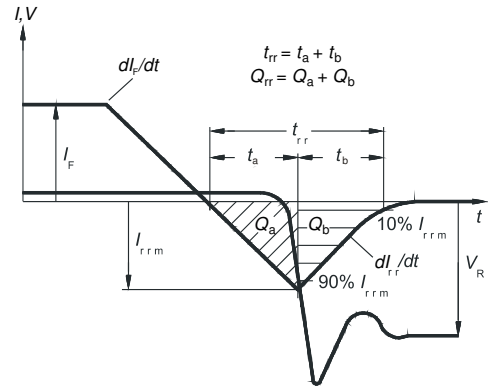

Figure C. Definition of diode switching characteristics

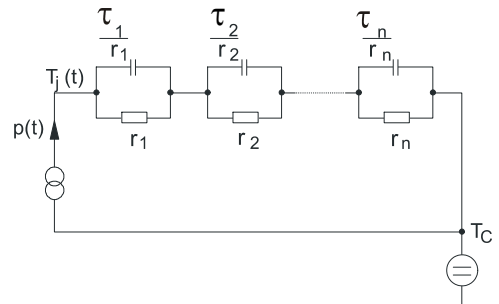

Figure D. Thermal equivalent circuit

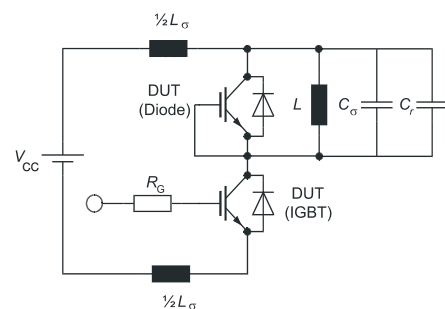

Figure E. Dynamic test circuit  
Parasitic inductance  $L_{\sigma}$ ,  
parasitic capacitor  $C_{\sigma}$ ,  
relief capacitor  $C_r$ ,  
(only for ZVT switching)

---

Sixth generation, high speed soft switching series

## Revision History

---

IKW40N120CS6

**Revision: 2018-05-07, Rev. 2.1**

---

Previous Revision

---

| Revision | Date       | Subjects (major changes since last revision) |
|----------|------------|--|
| 2.1      | 2018-05-07 | Final data sheet                             |

## Trademarks

All referenced product or service names and trademarks are the property of their respective owners.

**Published by**  
**Infineon Technologies AG**  
**81726 München, Germany**  
**© Infineon Technologies AG 2018.**  
**All Rights Reserved.**

## Important Notice

The information given in this document shall in no event be regarded as a guarantee of conditions or characteristics ("Beschaffenheitsgarantie"). With respect to any examples, hints or any typical values stated herein and/or any information regarding the application of the product, Infineon Technologies hereby disclaims any and all warranties and liabilities of any kind, including without limitation warranties of non-infringement of intellectual property rights of any third party.

In addition, any information given in this document is subject to customer's compliance with its obligations stated in this document and any applicable legal requirements, norms and standards concerning customer's products and any use of the product of Infineon Technologies in customer's applications.

The data contained in this document is exclusively intended for technically trained staff. It is the responsibility of customer's technical departments to evaluate the suitability of the product for the intended application and the completeness of the product information given in this document with respect to such application.

For further information on the product, technology, delivery terms and conditions and prices please contact your nearest Infineon Technologies office ([www.infineon.com](http://www.infineon.com)).

Please note that this product is not qualified according to the AEC Q100 or AEC Q101 documents of the Automotive Electronics Council.

## Warnings

Due to technical requirements products may contain dangerous substances. For information on the types in question please contact your nearest Infineon Technologies office.

Except as otherwise explicitly approved by Infineon Technologies in a written document signed by authorized representatives of Infineon Technologies, Infineon Technologies' products may not be used in any applications where a failure of the product or any consequences of the use thereof can reasonably be expected to result in personal injury.