



Chipsmall Limited consists of a professional team with an average of over 10 year of expertise in the distribution of electronic components. Based in Hongkong, we have already established firm and mutual-benefit business relationships with customers from,Europe,America and south Asia,supplying obsolete and hard-to-find components to meet their specific needs.

With the principle of “Quality Parts,Customers Priority,Honest Operation,and Considerate Service”,our business mainly focus on the distribution of electronic components. Line cards we deal with include Microchip,ALPS,ROHM,Xilinx,Pulse,ON,Everlight and Freescale. Main products comprise IC,Modules,Potentiometer,IC Socket,Relay,Connector.Our parts cover such applications as commercial,industrial, and automotives areas.

We are looking forward to setting up business relationship with you and hope to provide you with the best service and solution. Let us make a better world for our industry!



## Contact us

Tel: +86-755-8981 8866 Fax: +86-755-8427 6832

Email & Skype: info@chipsmall.com Web: www.chipsmall.com

Address: A1208, Overseas Decoration Building, #122 Zhenhua RD., Futian, Shenzhen, China



## TRENCHSTOP™ 5 soft switching IGBT

## TRENCHSTOP™ 5 high speed soft switching IGBT copacked with full current rated RAPID 1 fast and soft antiparallel diode

### Features and Benefits:

- High speed S5 technology offering
- High speed smooth switching device for hard & soft switching
- Very Low  $V_{CEsat}$ , 1.42V at nominal current
- Plug and play replacement of previous generation IGBTs
- 650V breakdown voltage
- Low gate charge  $Q_G$
- IGBT copacked with full rated RAPID 1 fast antiparallel diode
- Maximum junction temperature 175°C
- Qualified according to JEDEC for target applications
- Pb-free lead plating; RoHS compliant
- Complete product spectrum and PSpice Models:  
<http://www.infineon.com/igbt/>

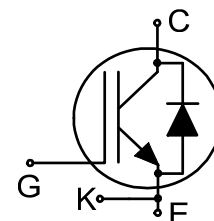

### Applications:

- Industrial UPS
- Industrial SMPS
- Energy Storage
- Charger
- Welding

### Product Validation:

Qualified for applications listed above based on the test conditions in the relevant tests of JEDEC20/22

### Package pin definition:

- Pin C & backside - collector
- Pin E - emitter
- Pin K - Kelvin emitter
- Pin G - gate

Please note: The emitter and Kelvin emitter pins are not exchangeable. Their exchange might lead to malfunction.



### Key Performance and Package Parameters

Type	$V_{CE}$	$I_C$	$V_{CEsat}$ , $T_{vj}=25^\circ\text{C}$	$T_{vjmax}$	Marking	Package
IKZ75N65ES5	650V	75A	1.42V	175°C	K75EES5	PG-TO247-4

### Table of Contents

Description .....	1
Table of Contents .....	2
Maximum Ratings .....	3
Thermal Resistance .....	3
Electrical Characteristics .....	4
Electrical Characteristics Diagrams .....	7
Package Drawing .....	13
Testing Conditions .....	14
Revision History .....	15
Disclaimer .....	16

## TRENCHSTOP™ 5 soft switching IGBT

## Maximum Ratings

For optimum lifetime and reliability, Infineon recommends operating conditions that do not exceed 80% of the maximum ratings stated in this datasheet.

Parameter	Symbol	Value	Unit
Collector-emitter voltage, $T_{vj} \geq 25^{\circ}\text{C}$	$V_{CE}$	650	V
DC collector current, limited by $T_{vjmax}^{1)}$ $T_C = 25^{\circ}\text{C}$ value limited by bondwire $T_C = 100^{\circ}\text{C}$	$I_C$	80.0 80.0	A
Pulsed collector current, $t_p$ limited by $T_{vjmax}$	$I_{Cpuls}$	300.0	A
Turn off safe operating area $V_{CE} \leq 650\text{V}$ , $T_{vj} \leq 175^{\circ}\text{C}$ , $t_p = 1\mu\text{s}$	-	300.0	A
Diode forward current, limited by $T_{vjmax}^{1)}$ $T_C = 25^{\circ}\text{C}$ value limited by bondwire $T_C = 100^{\circ}\text{C}$	$I_F$	80.0 80.0	A
Diode pulsed current, $t_p$ limited by $T_{vjmax}$	$I_{Fpuls}$	300.0	A
Gate-emitter voltage Transient Gate-emitter voltage ( $t_p \leq 10\mu\text{s}$ , $D < 0.010$ )	$V_{GE}$	$\pm 20$ $\pm 30$	V
Power dissipation $T_C = 25^{\circ}\text{C}$ Power dissipation $T_C = 100^{\circ}\text{C}$	$P_{tot}$	395.0 197.0	W
Operating junction temperature	$T_{vj}$	-40...+175	$^{\circ}\text{C}$
Storage temperature	$T_{stg}$	-55...+150	$^{\circ}\text{C}$
Soldering temperature, wave soldering 1.6mm (0.063in.) from case for 10s		260	$^{\circ}\text{C}$
Mounting torque, M3 screw Maximum of mounting processes: 3	$M$	0.6	Nm

## Thermal Resistance

Parameter	Symbol	Conditions	Value			Unit
			min.	typ.	max.	
<b>R<sub>th</sub> Characteristics</b>						
IGBT thermal resistance, junction - case	$R_{th(j-c)}$		-	-	0.38	K/W
Diode thermal resistance, junction - case	$R_{th(j-c)}$		-	-	0.46	K/W
Thermal resistance junction - ambient	$R_{th(j-a)}$		-	-	40	K/W

<sup>1)</sup> value limited by bondwire



## TRENCHSTOP™ 5 soft switching IGBT

Electrical Characteristic, at  $T_{vj} = 25^{\circ}\text{C}$ , unless otherwise specified

Parameter	Symbol	Conditions	Value			Unit
			min.	typ.	max.	
<b>Static Characteristic</b>						
Collector-emitter breakdown voltage	$V_{(BR)CES}$	$V_{GE} = 0\text{V}, I_C = 0.20\text{mA}$	650	-	-	V
Collector-emitter saturation voltage	$V_{CESat}$	$V_{GE} = 15.0\text{V}, I_C = 75.0\text{A}$ $T_{vj} = 25^{\circ}\text{C}$ $T_{vj} = 125^{\circ}\text{C}$ $T_{vj} = 175^{\circ}\text{C}$	-	1.42	1.75	V
			-	1.55	-	
			-	1.65	-	
Diode forward voltage	$V_F$	$V_{GE} = 0\text{V}, I_F = 75.0\text{A}$ $T_{vj} = 25^{\circ}\text{C}$ $T_{vj} = 125^{\circ}\text{C}$ $T_{vj} = 175^{\circ}\text{C}$	-	1.50	1.75	V
			-	1.48	-	
			-	1.45	-	
Gate-emitter threshold voltage	$V_{GE(th)}$	$I_C = 0.75\text{mA}, V_{CE} = V_{GE}$	3.2	4.0	4.8	V
Zero gate voltage collector current	$I_{CES}$	$V_{CE} = 650\text{V}, V_{GE} = 0\text{V}$ $T_{vj} = 25^{\circ}\text{C}$ $T_{vj} = 175^{\circ}\text{C}$	-	-	50	$\mu\text{A}$
			-	3000	-	
Gate-emitter leakage current	$I_{GES}$	$V_{CE} = 0\text{V}, V_{GE} = 20\text{V}$	-	-	100	nA
Transconductance	$g_{fs}$	$V_{CE} = 20\text{V}, I_C = 75.0\text{A}$	-	100.0	-	S

Electrical Characteristic, at  $T_{vj} = 25^{\circ}\text{C}$ , unless otherwise specified

Parameter	Symbol	Conditions	Value			Unit
			min.	typ.	max.	
<b>Dynamic Characteristic</b>						
Input capacitance	$C_{ies}$	$V_{CE} = 25\text{V}, V_{GE} = 0\text{V}, f = 1\text{MHz}$	-	4500	-	pF
Output capacitance	$C_{oes}$		-	130	-	
Reverse transfer capacitance	$C_{res}$		-	17	-	
Gate charge	$Q_G$	$V_{CC} = 520\text{V}, I_C = 75.0\text{A},$ $V_{GE} = 15\text{V}$	-	164.0	-	nC
Internal emitter inductance measured 5mm (0.197 in.) from case	$L_E$		-	13.0	-	nH

## Switching Characteristic, Inductive Load

Parameter	Symbol	Conditions	Value			Unit
			min.	typ.	max.	

IGBT Characteristic, at  $T_{vj} = 25^{\circ}\text{C}$ 

Turn-on delay time	$t_{d(on)}$	$T_{vj} = 25^{\circ}\text{C},$ $V_{CC} = 400\text{V}, I_C = 75.0\text{A},$ $V_{GE} = 0.0/15.0\text{V},$ $R_{G(on)} = 22.3\Omega, R_{G(off)} = 22.3\Omega,$ $L_{\sigma} = 30\text{nH}, C_{\sigma} = 30\text{pF}$ $L_{\sigma}, C_{\sigma}$ from Fig. E Energy losses include "tail" and diode reverse recovery.	-	46	-	ns
Rise time	$t_r$		-	25	-	ns
Turn-off delay time	$t_{d(off)}$		-	405	-	ns
Fall time	$t_f$		-	22	-	ns
Turn-on energy	$E_{on}$		-	1.30	-	mJ
Turn-off energy	$E_{off}$		-	1.50	-	mJ
Total switching energy	$E_{ts}$	-	2.80	-	mJ	

TRENCHSTOP™ 5 soft switching IGBT

Turn-on delay time	$t_{d(on)}$	$T_{vj} = 25^{\circ}\text{C}$ , $V_{CC} = 400\text{V}$ , $I_C = 37.5\text{A}$ , $V_{GE} = 0.0/15.0\text{V}$ , $R_{G(on)} = 22.3\Omega$ , $R_{G(off)} = 22.3\Omega$ , $L\sigma = 30\text{nH}$ , $C\sigma = 30\text{pF}$ $L\sigma$ , $C\sigma$ from Fig. E Energy losses include "tail" and diode reverse recovery.	-	43	-	ns
Rise time	$t_r$		-	17	-	ns
Turn-off delay time	$t_{d(off)}$		-	430	-	ns
Fall time	$t_f$		-	19	-	ns
Turn-on energy	$E_{on}$		-	0.60	-	mJ
Turn-off energy	$E_{off}$		-	0.50	-	mJ
Total switching energy	$E_{ts}$		-	1.10	-	mJ

Diode Characteristic, at  $T_{vj} = 25^{\circ}\text{C}$

Diode reverse recovery time	$t_{rr}$	$T_{vj} = 25^{\circ}\text{C}$ , $V_R = 400\text{V}$ , $I_F = 75.0\text{A}$ , $di_F/dt = 2500\text{A}/\mu\text{s}$	-	72	-	ns
Diode reverse recovery charge	$Q_{rr}$		-	1.40	-	$\mu\text{C}$
Diode peak reverse recovery current	$I_{rrm}$		-	39.0	-	A
Diode peak rate of fall of reverse recovery current during $t_b$	$di_{rr}/dt$		-	-700	-	$\text{A}/\mu\text{s}$

Diode reverse recovery time	$t_{rr}$	$T_{vj} = 25^{\circ}\text{C}$ , $V_R = 400\text{V}$ , $I_F = 37.5\text{A}$ , $di_F/dt = 2500\text{A}/\mu\text{s}$	-	47	-	ns
Diode reverse recovery charge	$Q_{rr}$		-	1.00	-	$\mu\text{C}$
Diode peak reverse recovery current	$I_{rrm}$		-	36.0	-	A
Diode peak rate of fall of reverse recovery current during $t_b$	$di_{rr}/dt$		-	-1300	-	$\text{A}/\mu\text{s}$

Switching Characteristic, Inductive Load

Parameter	Symbol	Conditions	Value			Unit
			min.	typ.	max.	

IGBT Characteristic, at  $T_{vj} = 150^{\circ}\text{C}$

Turn-on delay time	$t_{d(on)}$	$T_{vj} = 150^{\circ}\text{C}$ , $V_{CC} = 400\text{V}$ , $I_C = 75.0\text{A}$ , $V_{GE} = 0.0/15.0\text{V}$ , $R_{G(on)} = 22.3\Omega$ , $R_{G(off)} = 22.3\Omega$ , $L\sigma = 30\text{nH}$ , $C\sigma = 30\text{pF}$ $L\sigma$ , $C\sigma$ from Fig. E Energy losses include "tail" and diode reverse recovery.	-	42	-	ns
Rise time	$t_r$		-	28	-	ns
Turn-off delay time	$t_{d(off)}$		-	450	-	ns
Fall time	$t_f$		-	25	-	ns
Turn-on energy	$E_{on}$		-	1.70	-	mJ
Turn-off energy	$E_{off}$		-	1.90	-	mJ
Total switching energy	$E_{ts}$		-	3.60	-	mJ

Turn-on delay time	$t_{d(on)}$	$T_{vj} = 150^{\circ}\text{C}$ , $V_{CC} = 400\text{V}$ , $I_C = 37.5\text{A}$ , $V_{GE} = 0.0/15.0\text{V}$ , $R_{G(on)} = 22.3\Omega$ , $R_{G(off)} = 22.3\Omega$ , $L\sigma = 30\text{nH}$ , $C\sigma = 30\text{pF}$ $L\sigma$ , $C\sigma$ from Fig. E Energy losses include "tail" and diode reverse recovery.	-	38	-	ns
Rise time	$t_r$		-	18	-	ns
Turn-off delay time	$t_{d(off)}$		-	480	-	ns
Fall time	$t_f$		-	36	-	ns
Turn-on energy	$E_{on}$		-	1.00	-	mJ
Turn-off energy	$E_{off}$		-	0.70	-	mJ
Total switching energy	$E_{ts}$		-	1.70	-	mJ

## TRENCHSTOP™ 5 soft switching IGBT

Diode Characteristic, at  $T_{vj} = 150^{\circ}\text{C}$ 

Diode reverse recovery time	$t_{rr}$	$T_{vj} = 150^{\circ}\text{C},$ $V_R = 400\text{V},$ $I_F = 75.0\text{A},$ $di_F/dt = 2500\text{A}/\mu\text{s}$	-	115	-	ns
Diode reverse recovery charge	$Q_{rr}$		-	4.00	-	$\mu\text{C}$
Diode peak reverse recovery current	$I_{rrm}$		-	64.0	-	A
Diode peak rate of fall of reverse recovery current during $t_b$	$di_{rr}/dt$		-	-800	-	$\text{A}/\mu\text{s}$
Diode reverse recovery time	$t_{rr}$	$T_{vj} = 150^{\circ}\text{C},$ $V_R = 400\text{V},$ $I_F = 37.5\text{A},$ $di_F/dt = 2500\text{A}/\mu\text{s}$	-	85	-	ns
Diode reverse recovery charge	$Q_{rr}$		-	2.80	-	$\mu\text{C}$
Diode peak reverse recovery current	$I_{rrm}$		-	60.0	-	A
Diode peak rate of fall of reverse recovery current during $t_b$	$di_{rr}/dt$		-	-1100	-	$\text{A}/\mu\text{s}$

TRENCHSTOP™ 5 soft switching IGBT

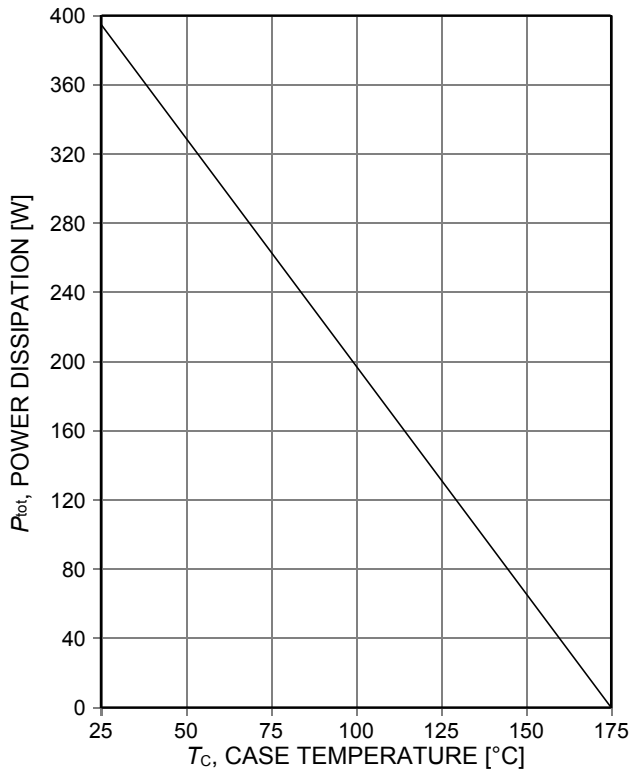

Figure 1. Power dissipation as a function of case temperature ( $T_{vj} \leq 175^\circ\text{C}$ )

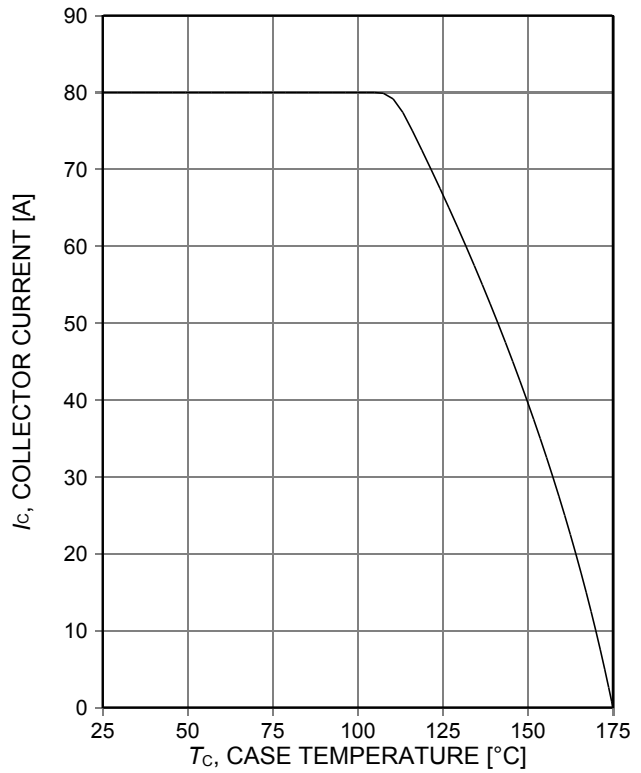

Figure 2. Collector current as a function of case temperature ( $V_{GE} \geq 15\text{V}$ ,  $T_{vj} \leq 175^\circ\text{C}$ )

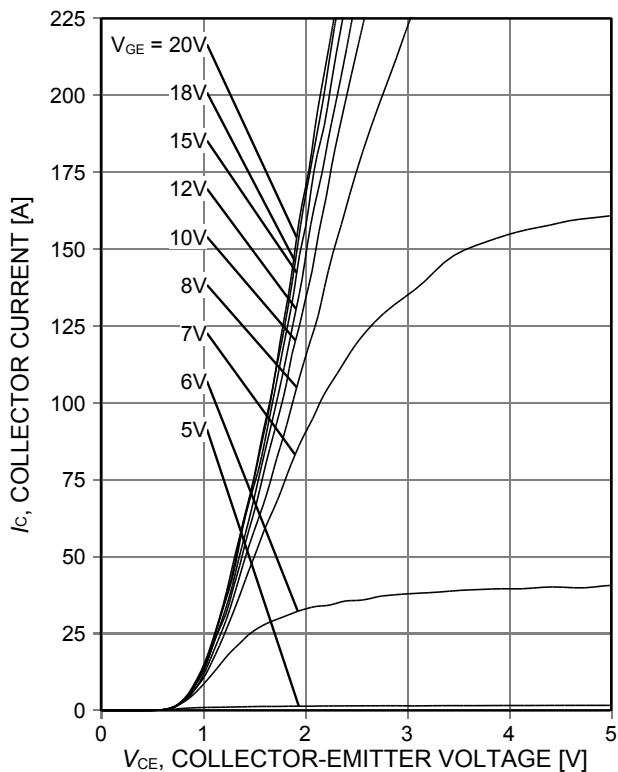

Figure 3. Typical output characteristic ( $T_{vj} = 25^\circ\text{C}$ )

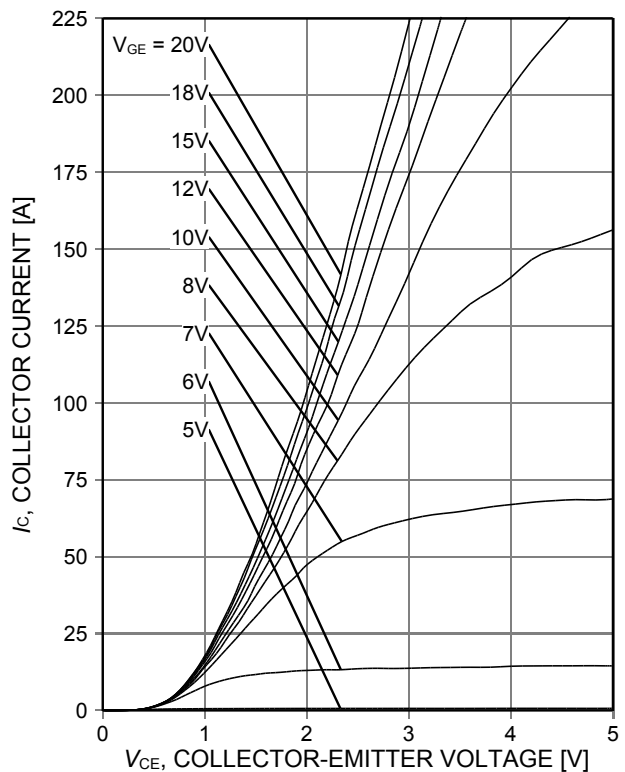

Figure 4. Typical output characteristic ( $T_{vj} = 175^\circ\text{C}$ )



TRENCHSTOP™ 5 soft switching IGBT

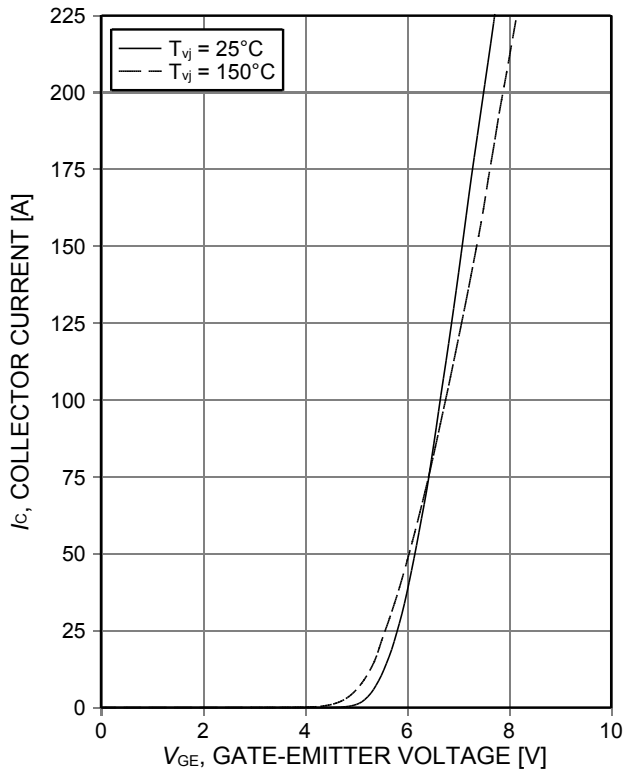

Figure 5. Typical transfer characteristic ( $V_{CE}=20V$ )

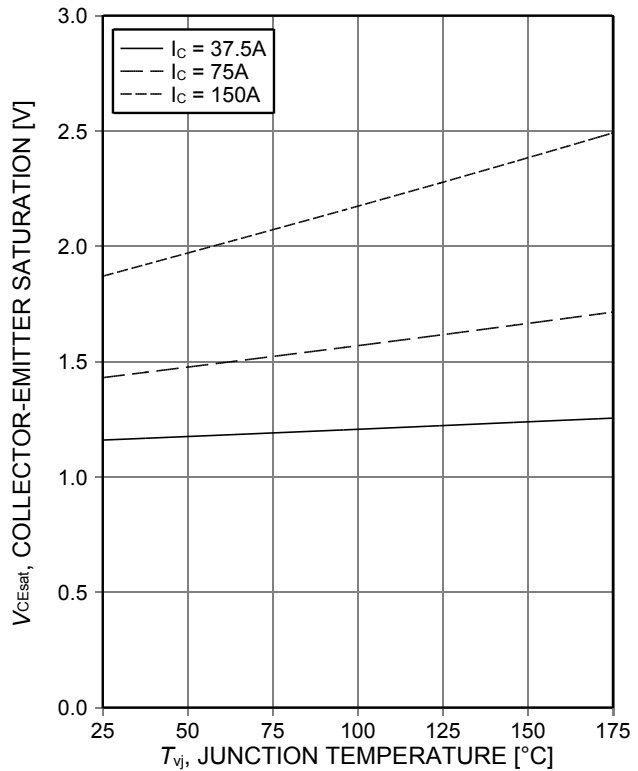

Figure 6. Typical collector-emitter saturation voltage as a function of junction temperature ( $V_{GE}=15V$ )

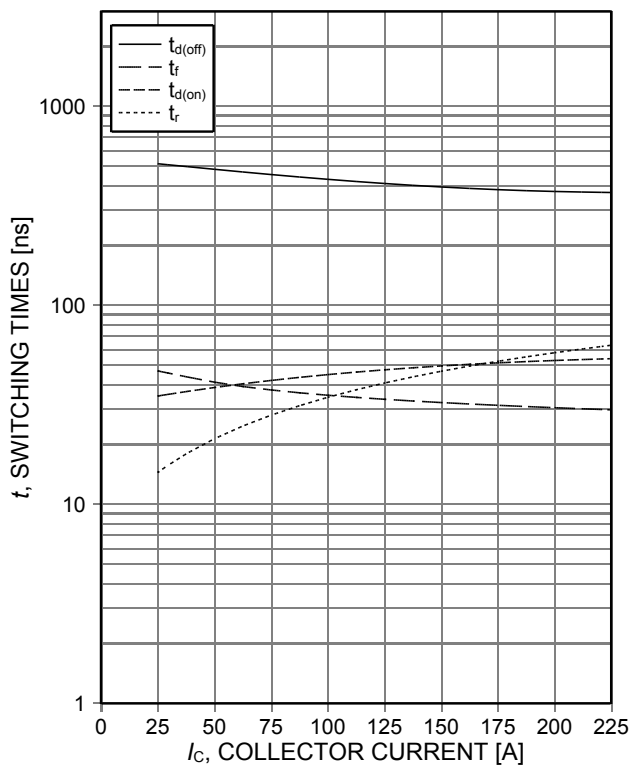

Figure 7. Typical switching times as a function of collector current (inductive load,  $T_{vj}=150^{\circ}C$ ,  $V_{CE}=400V$ ,  $V_{GE}=0/15V$ ,  $R_{Gon}=22,3\Omega$ ,  $R_{Goff}=22,3\Omega$ , dynamic test circuit in Figure E)

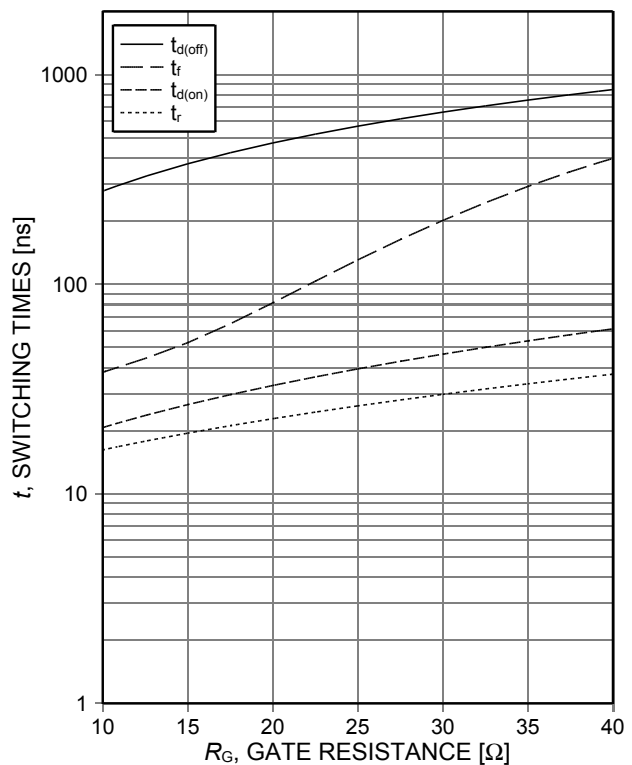

Figure 8. Typical switching times as a function of gate resistance (inductive load,  $T_{vj}=150^{\circ}C$ ,  $V_{CE}=400V$ ,  $V_{GE}=0/15V$ ,  $I_C=75A$ , dynamic test circuit in Figure E)

TRENCHSTOP™ 5 soft switching IGBT

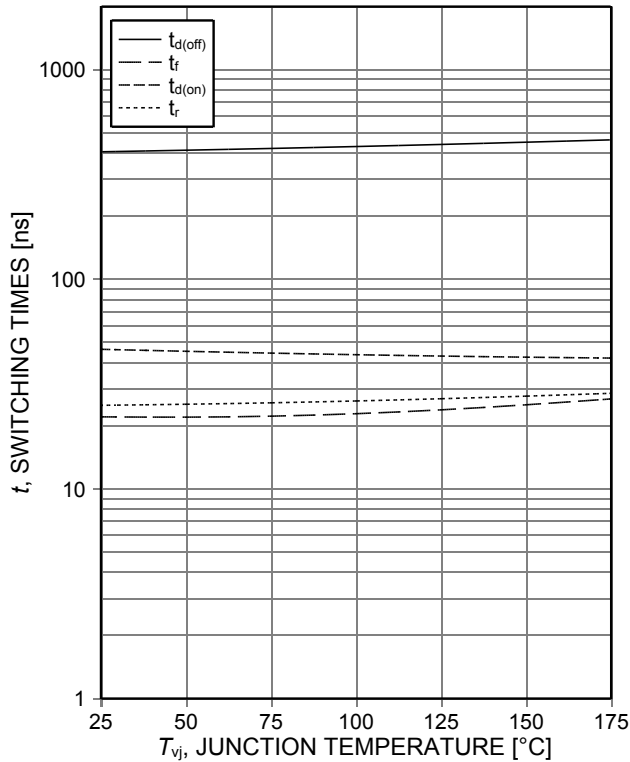

Figure 9. **Typical switching times as a function of junction temperature**  
 (inductive load,  $V_{CE}=400V$ ,  $V_{GE}=0/15V$ ,  $I_C=75A$ ,  $R_{Gon}=22,3\Omega$ ,  $R_{Goff}=22,3\Omega$ , dynamic test circuit in Figure E)

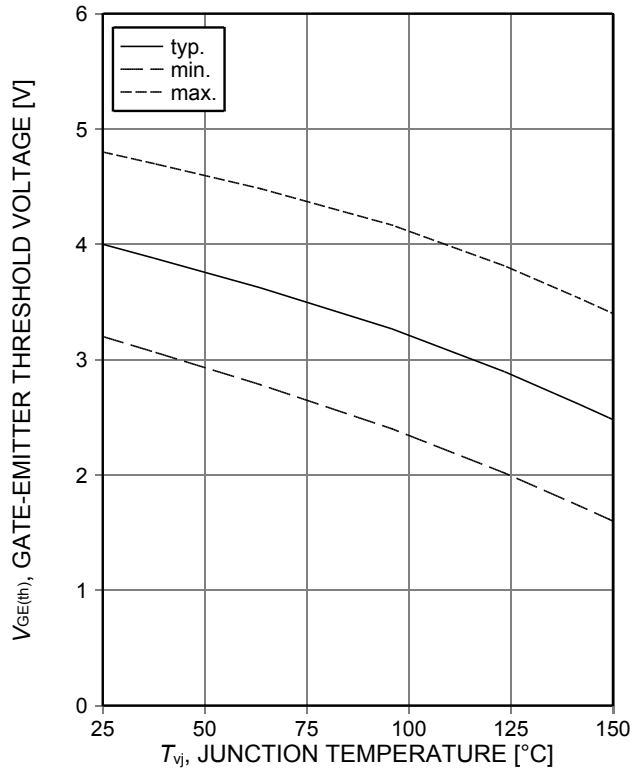

Figure 10. **Gate-emitter threshold voltage as a function of junction temperature**  
 ( $I_C=0.75mA$ )

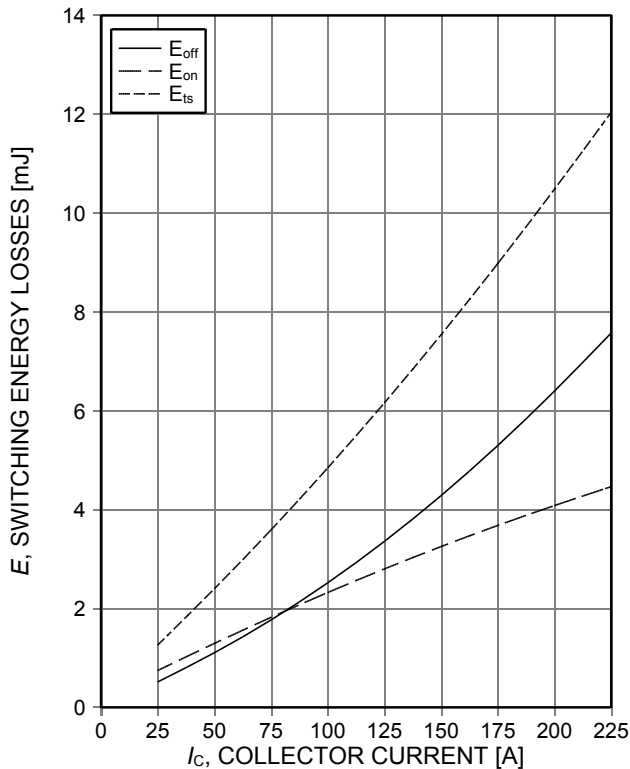

Figure 11. **Typical switching energy losses as a function of collector current**  
 (inductive load,  $T_{vj}=150^\circ C$ ,  $V_{CE}=400V$ ,  $V_{GE}=0/15V$ ,  $R_{Gon}=22,3\Omega$ ,  $R_{Goff}=22,3\Omega$ , dynamic test circuit in Figure E)

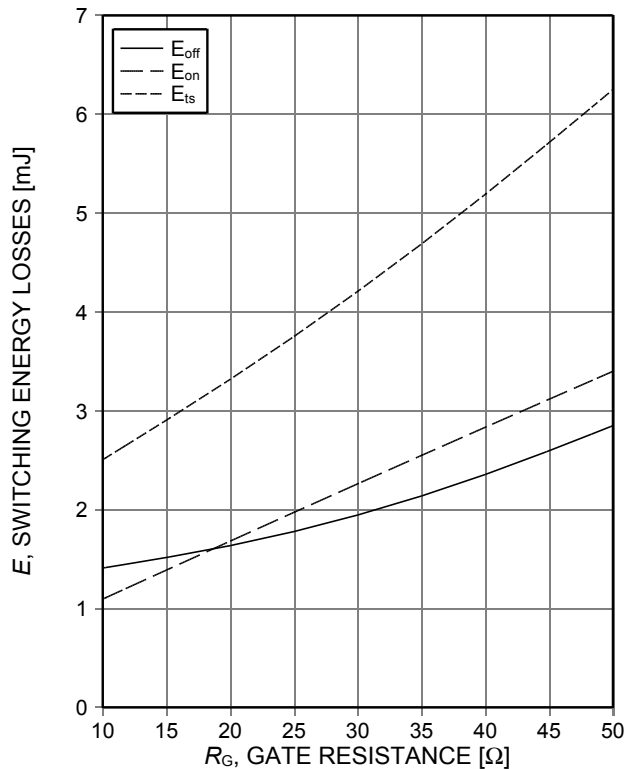

Figure 12. **Typical switching energy losses as a function of gate resistance**  
 (inductive load,  $T_{vj}=150^\circ C$ ,  $V_{CE}=400V$ ,  $V_{GE}=0/15V$ ,  $I_C=75A$ , dynamic test circuit in Figure E)

TRENCHSTOP™ 5 soft switching IGBT

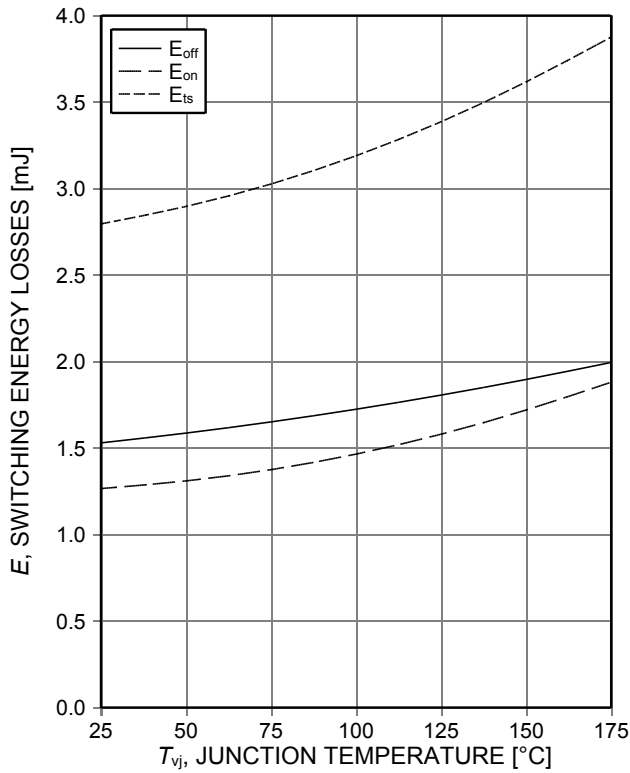

Figure 13. **Typical switching energy losses as a function of junction temperature** (inductive load,  $V_{CE}=400V$ ,  $V_{GE}=0/15V$ ,  $I_C=75A$ ,  $R_{Gon}=22,3\Omega$ ,  $R_{Goff}=22,3\Omega$ , dynamic test circuit in Figure E)

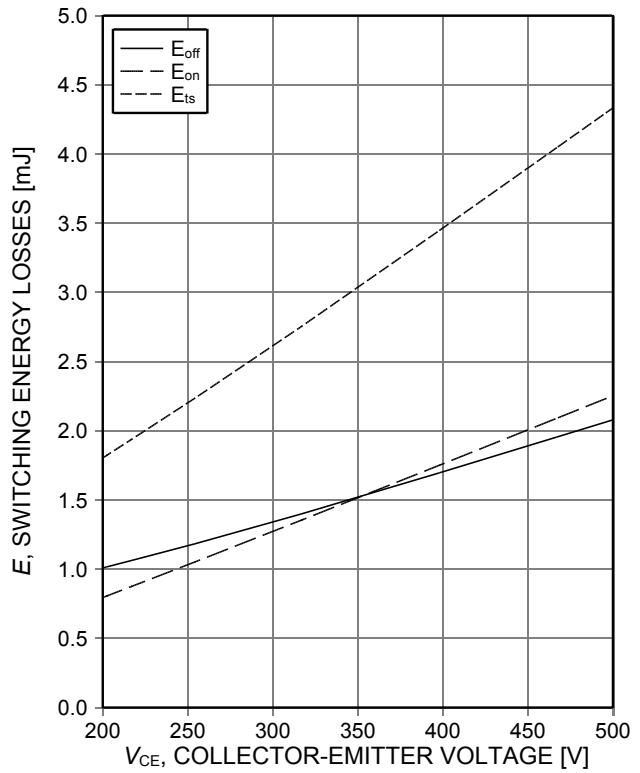

Figure 14. **Typical switching energy losses as a function of collector emitter voltage** (inductive load,  $T_{vj}=150^\circ C$ ,  $V_{GE}=0/15V$ ,  $I_C=75A$ ,  $R_{Gon}=22,3\Omega$ ,  $R_{Goff}=22,3\Omega$ , dynamic test circuit in Figure E)

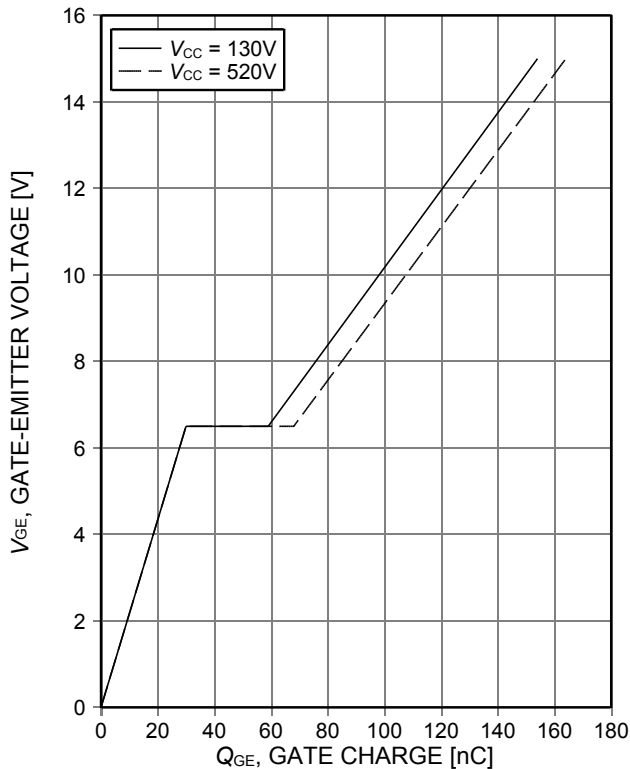

Figure 15. **Typical gate charge** ( $I_C=75A$ )

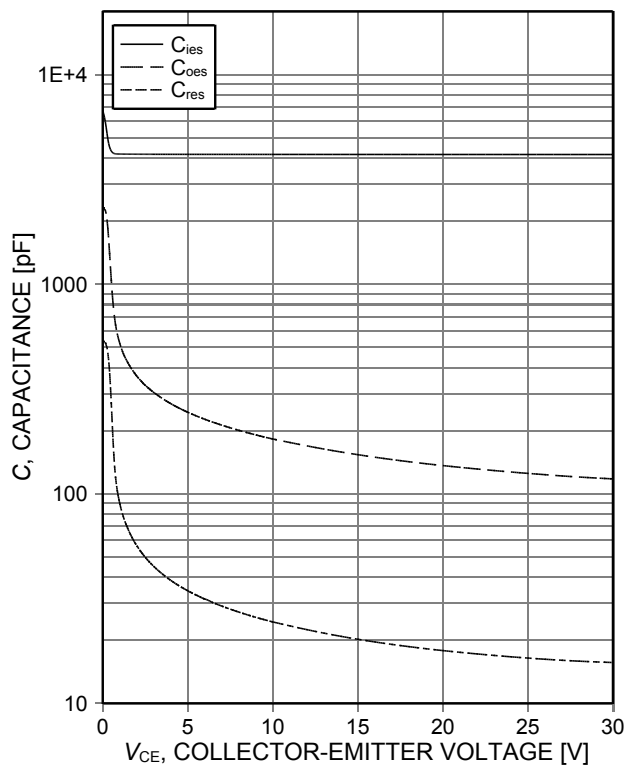

Figure 16. **Typical capacitance as a function of collector-emitter voltage** ( $V_{GE}=0V$ ,  $f=1MHz$ )

TRENCHSTOP™ 5 soft switching IGBT

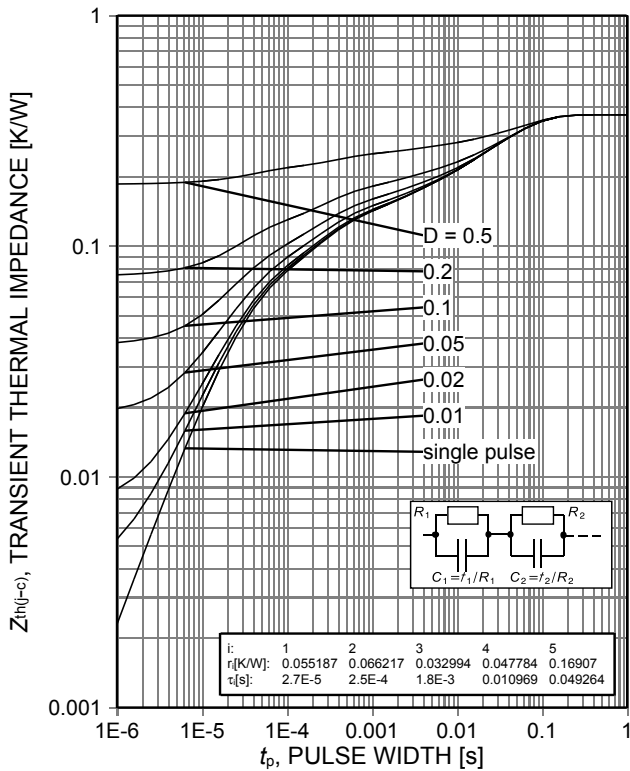

Figure 17. IGBT transient thermal impedance ( $D=t_p/T$ )

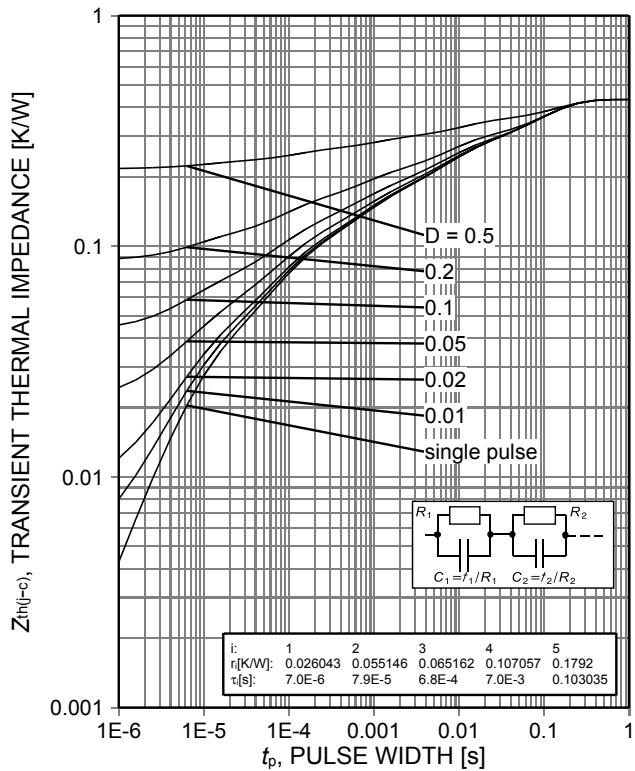

Figure 18. Diode transient thermal impedance as a function of pulse width ( $D=t_p/T$ )

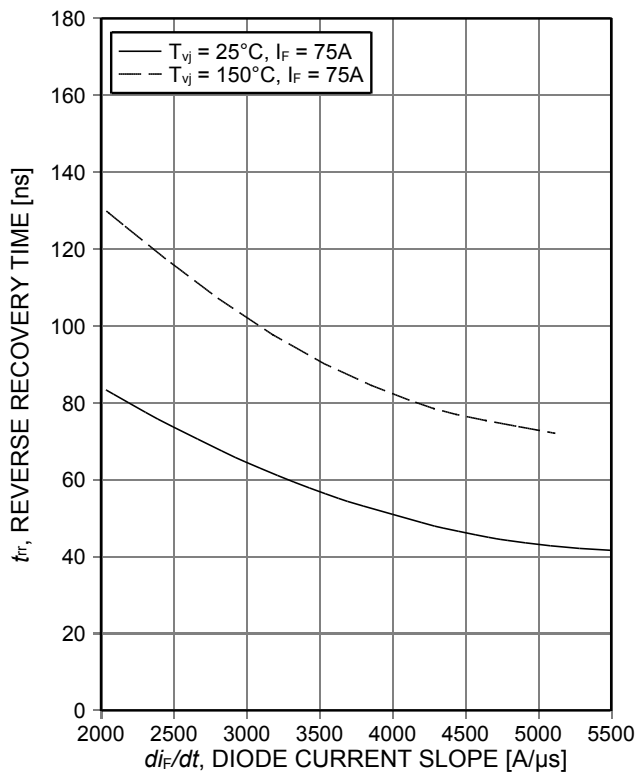

Figure 19. Typical reverse recovery time as a function of diode current slope ( $V_R=400V$ )

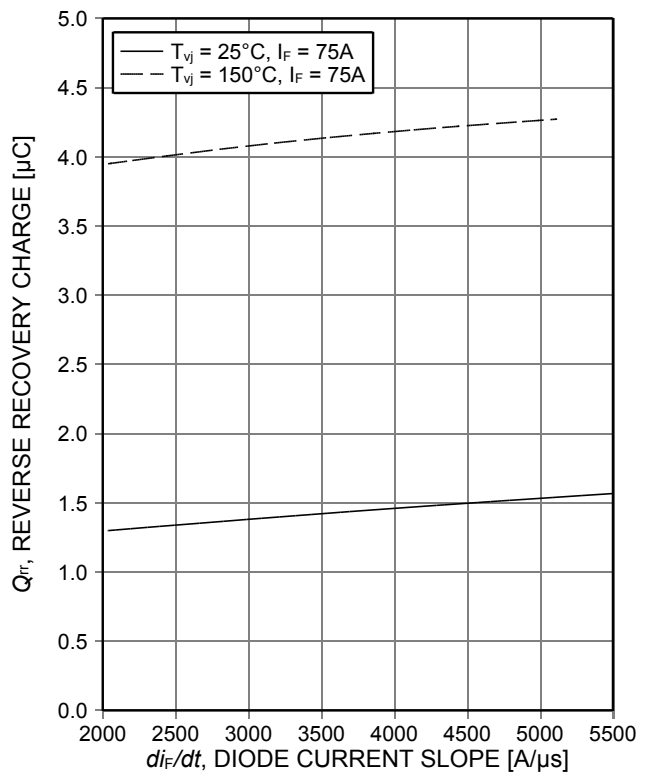

Figure 20. Typical reverse recovery charge as a function of diode current slope ( $V_R=400V$ )

TRENCHSTOP™ 5 soft switching IGBT

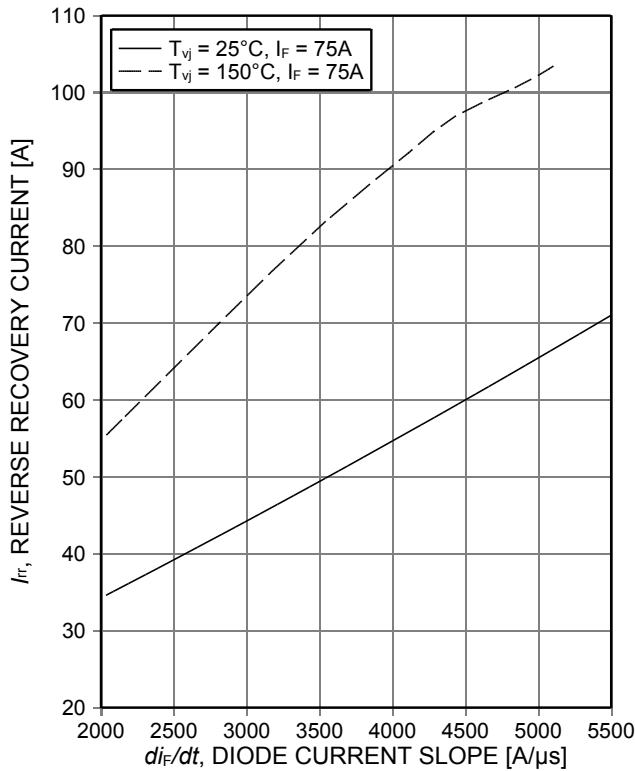

Figure 21. Typical reverse recovery current as a function of diode current slope (V<sub>R</sub>=400V)

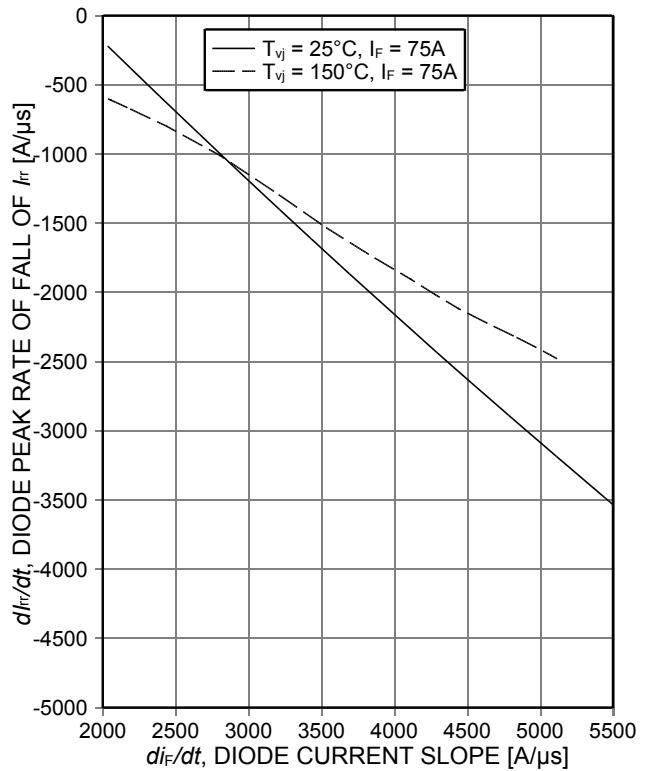

Figure 22. Typical diode peak rate of fall of reverse recovery current as a function of diode current slope (V<sub>R</sub>=400V)

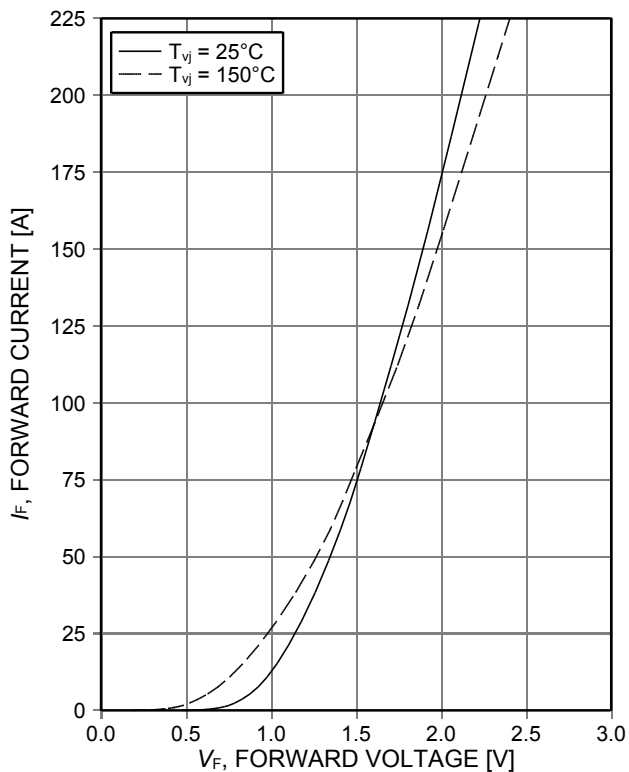

Figure 23. Typical diode forward current as a function of forward voltage

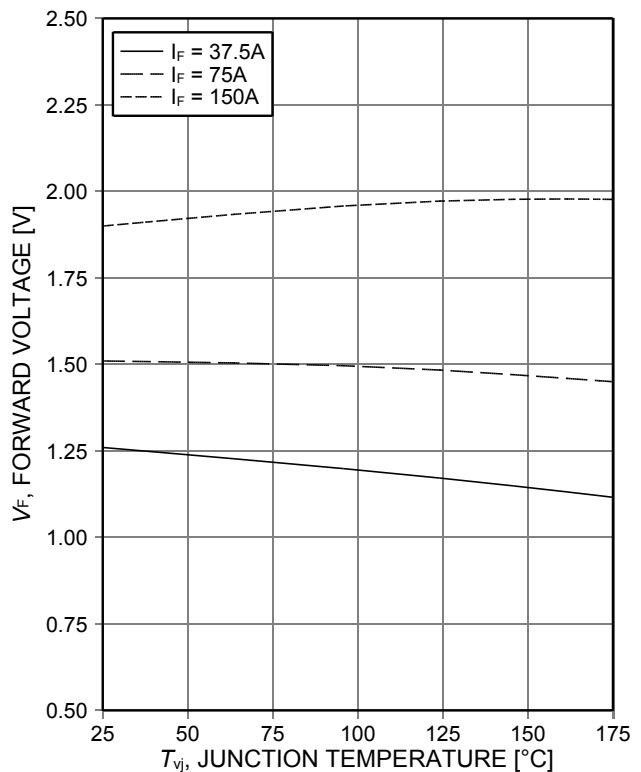
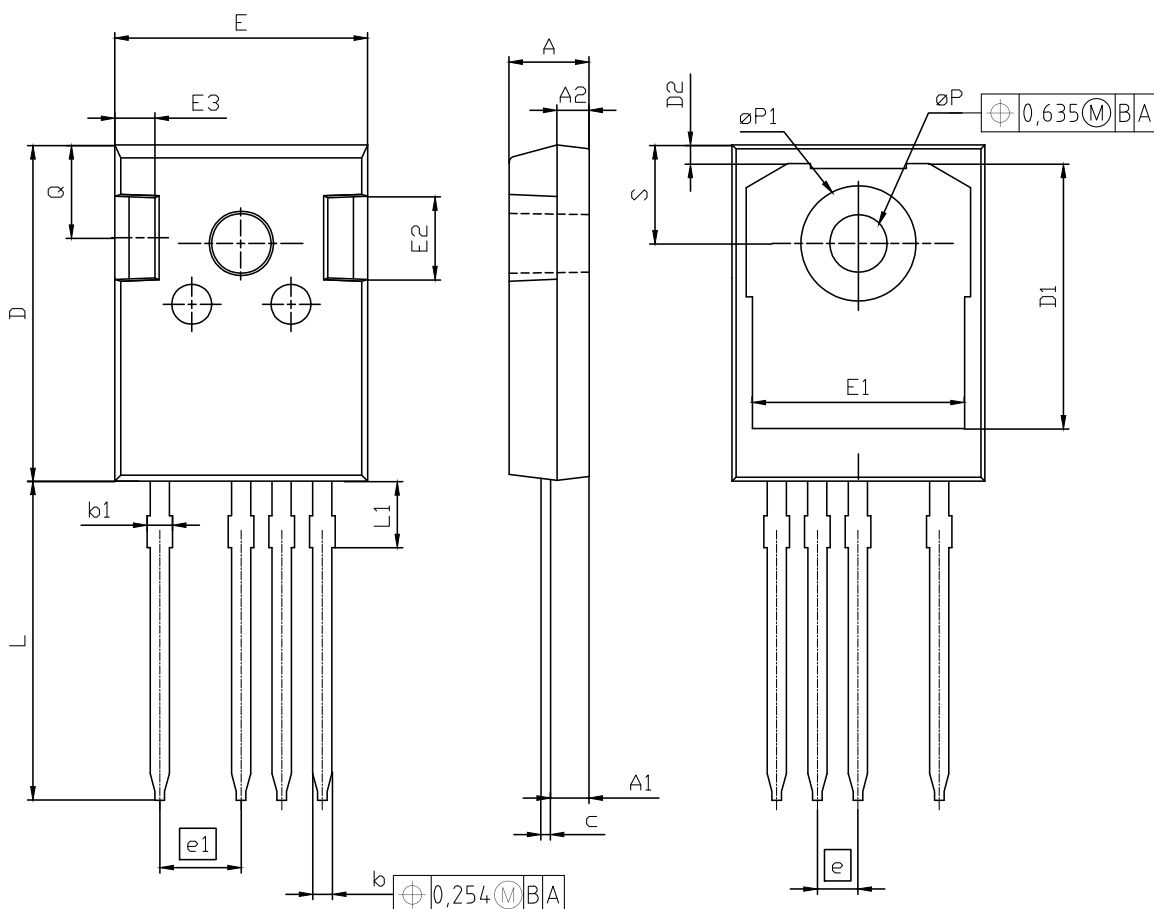

Figure 24. Typical diode forward voltage as a function of junction temperature



TRENCHSTOP™ 5 soft switching IGBT

Package Drawing PG-TO247-4



DIM	MILLIMETERS		INCHES	
	MIN	MAX	MIN	MAX
A	4.83	5.21	0.190	0.205
A1	2.29	2.54	0.090	0.100
A2	1.90	2.16	0.075	0.085
b	1.07	1.33	0.042	0.052
b1	1.10	1.70	0.043	0.067
c	0.50	0.70	0.020	0.028
D	20.80	21.10	0.819	0.831
D1	16.25	17.65	0.640	0.695
D2	0.95	1.35	0.037	0.053
E	15.70	16.13	0.618	0.635
E1	13.10	14.15	0.516	0.557
E2	3.68	5.10	0.145	0.201
E3	1.00	2.60	0.039	0.102
e	2.54 (BSC)		0.100 (BSC)	
e1	5.08		0.200	
N	4		4	
L	19.72	20.32	0.776	0.800
L1	4.02	4.40	0.158	0.173
ØP	3.50	3.70	0.138	0.146
ØP1	7.00	7.40	0.276	0.291
Q	5.49	6.00	0.216	0.236
S	6.04	6.30	0.238	0.248

**DOCUMENT NO.**  
Z8B00168124

**SCALE**

**EUROPEAN PROJECTION**

**ISSUE DATE**  
29-01-2013

**REVISION**  
1

TRENCHSTOP™ 5 soft switching IGBT

Testing Conditions

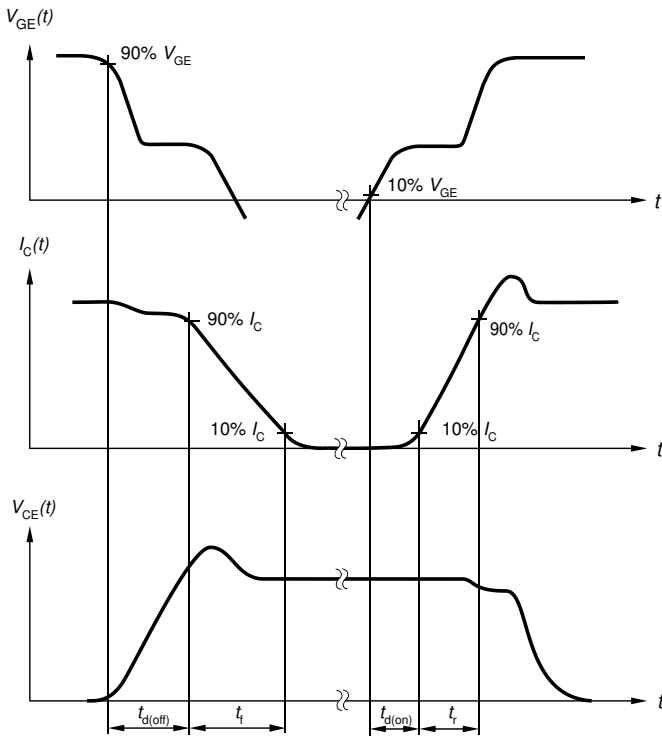

Figure A. Definition of switching times

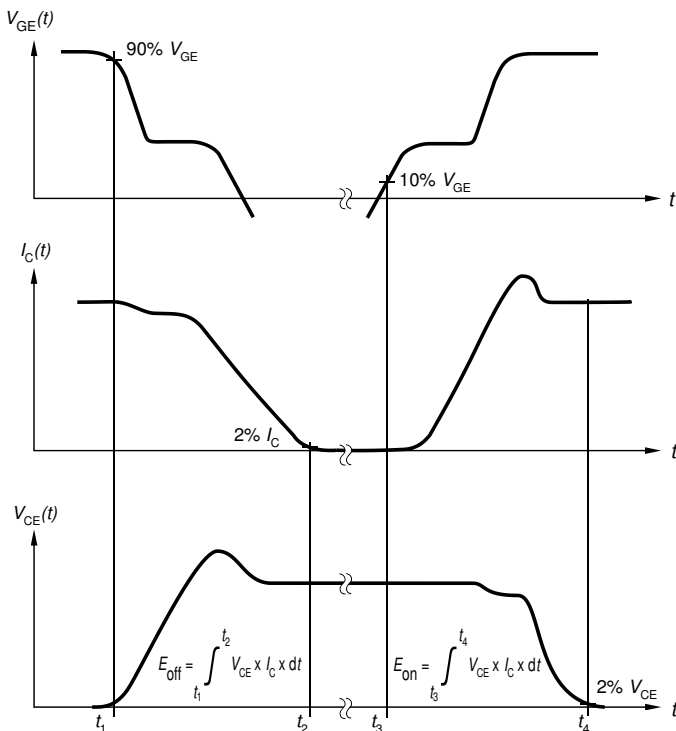

Figure B. Definition of switching losses

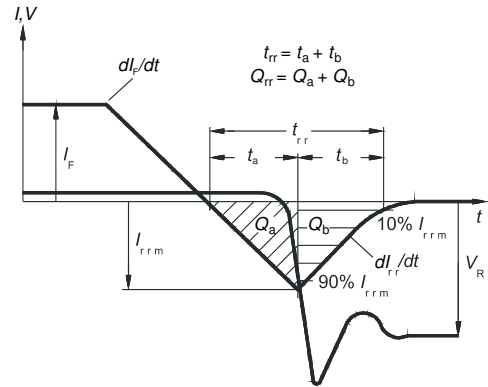

Figure C. Definition of diode switching characteristics

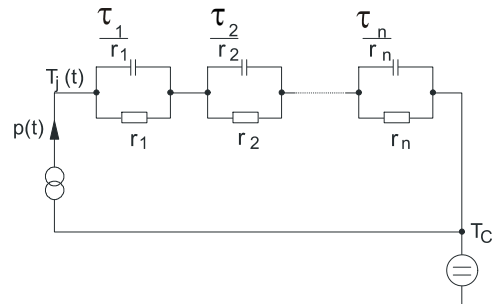

Figure D. Thermal equivalent circuit

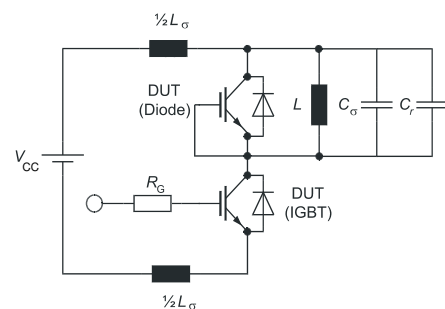

Figure E. Dynamic test circuit  
Parasitic inductance  $L_{\sigma}$ ,  
parasitic capacitor  $C_{\sigma}$ ,  
relief capacitor  $C_r$ ,  
(only for ZVT switching)

---

## TRENCHSTOP™ 5 soft switching IGBT

### Revision History

---

IKZ75N65ES5

**Revision: 2017-04-26, Rev. 2.1**

---

Previous Revision

Revision	Date	Subjects (major changes since last revision)
2.1	2017-04-26	Final data sheet

### **Trademarks of Infineon Technologies AG**

μHVIC™, μIPM™, μPFC™, AU-ConvertIR™, AURIX™, C166™, CanPAK™, CIPOS™, CIPURSE™, CoolDP™, CoolGaN™, COOLiR™, CoolMOS™, CoolSET™, CoolSiC™, DAVE™, DI-POL™, DirectFET™, DrBlade™, EasyPIM™, EconoBRIDGE™, EconoDUAL™, EconoPACK™, EconoPIM™, EiceDRIVER™, eupec™, FCOS™, GaNpowIR™, HEXFET™, HITFET™, HybridPACK™, iMOTION™, IRAM™, ISOFACE™, IsoPACK™, LEDriviR™, LITIX™, MIPAQ™, ModSTACK™, my-d™, NovalithIC™, OPTIGA™, OptiMOS™, ORIGA™, PowIRaudio™, PowIRstage™, PrimePACK™, PrimeSTACK™, PROFET™, PRO-SIL™, RASIC™, REAL3™, SmartLEWIS™, SOLID FLASH™, SPOC™, StrongIRFET™, SuplRBuck™, TEMPFET™, TRENCHSTOP™, TriCore™, UHVIC™, XHP™, XMC™

Trademarks updated November 2015

### **Other Trademarks**

All referenced product or service names and trademarks are the property of their respective owners.

**Published by**  
**Infineon Technologies AG**  
**81726 München, Germany**  
**© Infineon Technologies AG 2017.**  
**All Rights Reserved.**

### **Important Notice**

The information given in this document shall in no event be regarded as a guarantee of conditions or characteristics ("Beschaffenheitsgarantie"). With respect to any examples, hints or any typical values stated herein and/or any information regarding the application of the product, Infineon Technologies hereby disclaims any and all warranties and liabilities of any kind, including without limitation warranties of non-infringement of intellectual property rights of any third party.

In addition, any information given in this document is subject to customer's compliance with its obligations stated in this document and any applicable legal requirements, norms and standards concerning customer's products and any use of the product of Infineon Technologies in customer's applications.

The data contained in this document is exclusively intended for technically trained staff. It is the responsibility of customer's technical departments to evaluate the suitability of the product for the intended application and the completeness of the product information given in this document with respect to such application.

For further information on the product, technology, delivery terms and conditions and prices please contact your nearest Infineon Technologies office ([www.infineon.com](http://www.infineon.com)).

Please note that this product is not qualified according to the AEC Q100 or AEC Q101 documents of the Automotive Electronics Council.

### **Warnings**

Due to technical requirements products may contain dangerous substances. For information on the types in question please contact your nearest Infineon Technologies office.

Except as otherwise explicitly approved by Infineon Technologies in a written document signed by authorized representatives of Infineon Technologies, Infineon Technologies' products may not be used in any applications where a failure of the product or any consequences of the use thereof can reasonably be expected to result in personal injury.