



Chipsmall Limited consists of a professional team with an average of over 10 year of expertise in the distribution of electronic components. Based in Hongkong, we have already established firm and mutual-benefit business relationships with customers from,Europe,America and south Asia,supplying obsolete and hard-to-find components to meet their specific needs.

With the principle of "Quality Parts,Customers Priority,Honest Operation,and Considerate Service",our business mainly focus on the distribution of electronic components. Line cards we deal with include Microchip,ALPS,ROHM,Xilinx,Pulse,ON,Everlight and Freescale. Main products comprise IC,Modules,Potentiometer,IC Socket,Relay,Connector.Our parts cover such applications as commercial,industrial, and automotives areas.

We are looking forward to setting up business relationship with you and hope to provide you with the best service and solution. Let us make a better world for our industry!



Contact us

Tel: +86-755-8981 8866 Fax: +86-755-8427 6832

Email & Skype: info@chipsmall.com Web: www.chipsmall.com

Address: A1208, Overseas Decoration Building, #122 Zhenhua RD., Futian, Shenzhen, China



SJ035499
(図面番号) DRAWING NO.

版数 REV.	年月日 DATE	CON NO.	変更内容 DESCRIPTION	製図 DR.	担当 CHK.	査閲 APPD.	承認 APPD.
2	11.Sep.2002	50607	Additoin of bilingual expression.		N.OGAWA	—	T.OKA
3	12.Nov.2002	50957	Addition of note.		N.OGAWA	—	T.OKA
4	14.Jul.2003	52480	ADDED SPECIFICATION		N.OGAWA	—	T.OKA

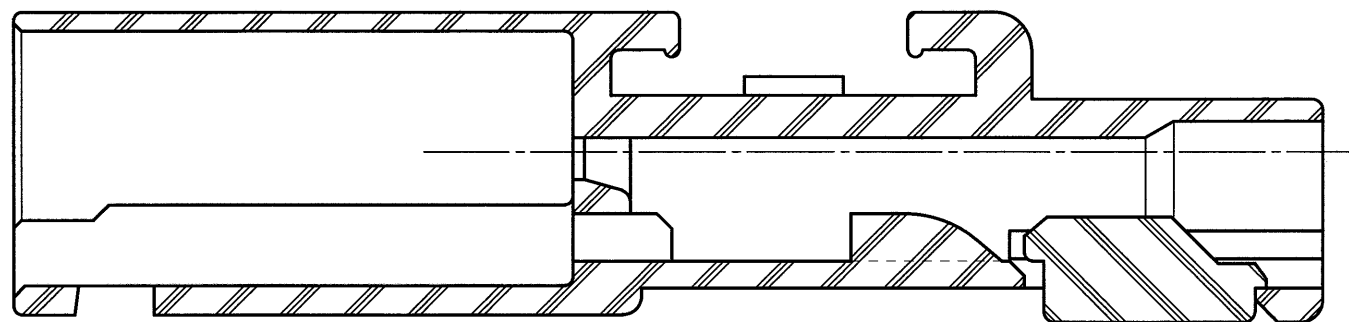
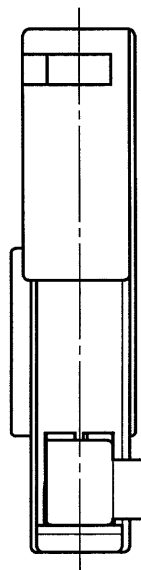
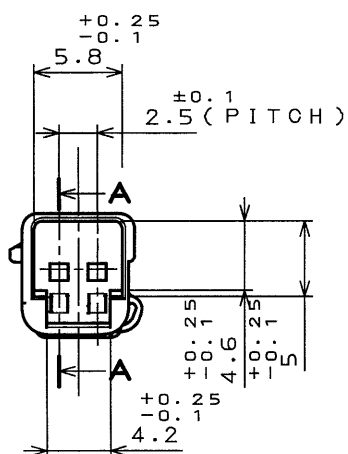
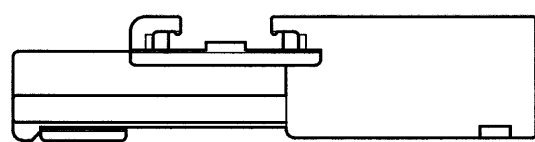
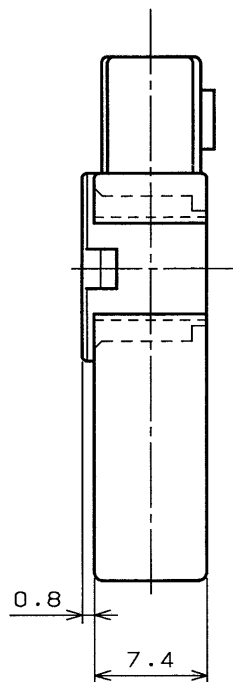

SECT. A-A
(SCALE 5:1)

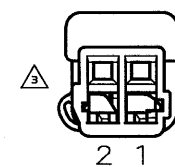
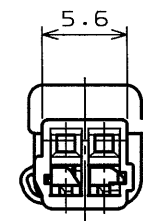
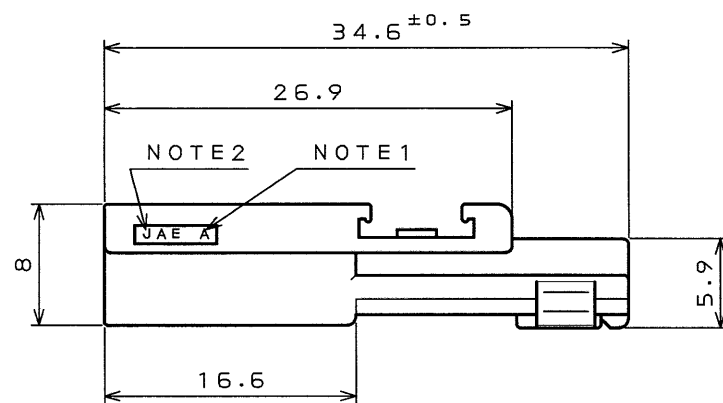

- 注1.金型マークを浮き出す。
- 2.社標を浮き出す。
- △3.端子番号は右図による。

NOTE1.TOOLING MARK APPEARS IN RAISED LETTERS.
2.COMPANY LOGO "JAE" APPEARS IN RAISED LETTERS.
△ 3.THE RIGHT FIGURE SHOWED A CONTACT NUMBER.

DISASSEMBLED CONDITION OF TERMINAL(REF.)

1	PIN HOUSING	PBT	COLOR: GREEN
符号 NO.	名称 DESCRIPTION	個数 QTY.	仕上 FINISH
		材 料 MATERIAL	備 考 REMARKS
仕様書(SPECIFICATION) △ JACS-1309-5		第1版(OBJECTIVE DATE) 20.Oct.2000	尺 寸 (SCALE) 2:1
公差(GENERAL TOLERANCE)		製図 DR.	名称(TITLE) Reference Only
寸法(DIMENSION)		担当 CHK. N.OGAWA	IL-AG9-2P-S301 PIN HOUSING
角度(ANGLES)		査閲 APPD.	
. ±0.4	×° ±	承認 APPD. T.TOTANI	重量(WEIGHT)
.X ±0.4	×°X ±		図面番号(DRAWING NO.) SJ035499
.XX ±			版数 (REV.) 4
.XXX ±			

