



Chipsmall Limited consists of a professional team with an average of over 10 year of expertise in the distribution of electronic components. Based in Hongkong, we have already established firm and mutual-benefit business relationships with customers from,Europe,America and south Asia,supplying obsolete and hard-to-find components to meet their specific needs.

With the principle of “Quality Parts,Customers Priority,Honest Operation,and Considerate Service”,our business mainly focus on the distribution of electronic components. Line cards we deal with include Microchip,ALPS,ROHM,Xilinx,Pulse,ON,Everlight and Freescale. Main products comprise IC,Modules,Potentiometer,IC Socket,Relay,Connector.Our parts cover such applications as commercial,industrial, and automotives areas.

We are looking forward to setting up business relationship with you and hope to provide you with the best service and solution. Let us make a better world for our industry!



Contact us

Tel: +86-755-8981 8866 Fax: +86-755-8427 6832

Email & Skype: info@chipsmall.com Web: www.chipsmall.com

Address: A1208, Overseas Decoration Building, #122 Zhenhua RD., Futian, Shenzhen, China



Optocoupler, Phototriac Output, Zero Crossing, High dV/dt, Low Input Current

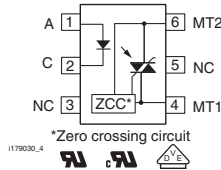
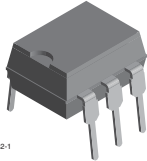

DESCRIPTION

The IL410 and IL4108 consists of a GaAs IRLED optically coupled to a photosensitive zero crossing TRIAC network. The TRIAC consists of two inverse parallel connected monolithic SCRs. These three semiconductor are assembled in a six pin dual in-line package.

High input sensitivity is achieved by using an emitter follower phototransistor and a cascaded SCR predriver resulting in an LED trigger current of less than 2 mA (DC). The use of a proprietary dV/dt clamp results in a static dV/dt of greater than 10 kV/ms. This clamp circuit has a MOSFET that is enhanced when high dV/dt spikes occur between MT1 and MT2 of the TRIAC. When conducting, the FET clamps the base of the phototransistor, disabling the first stage SCR predriver.

The zero cross line voltage detection circuit consists of two enhancement MOSFETS and a photodiode. The inhibit voltage of the network is determined by the enhancement voltage of the N-channel FET. The P-channel FET is enabled by a photocurrent source that permits the FET to conduct the main voltage to gate on the N-channel FET. Once the main voltage can enable the N-channel, it clamps the base of the phototransistor, disabling the first stage SCR predriver.

The 600 V, 800 V blocking voltage permits control of off-line voltages up to 240 V_{AC}, with a safety factor of more than two, and is sufficient for as much as 380 V_{AC}.

The IL410, IL4108 isolates low-voltage logic from 120 V_{AC}, 240 V_{AC}, and 380 V_{AC} lines to control resistive, inductive, or capacitive loads including motors, solenoids, high current thyristors or TRIAC and relays.

FEATURES

- High input sensitivity
- $I_{FT} = 2 \text{ mA}$, $PF = 1.0$
- $I_{FT} = 5 \text{ mA}$, $PF \leq 1.0$
- 300 mA on-state current
- Zero voltage crossing detector
- 600 V, 800 V blocking voltage
- High static dV/dt 10 kV/ μ s
- Very low leakage < 10 μ A
- Isolation test voltage 5300 V_{RMS}
- Small 6 pin DIP package
- Compliant to RoHS Directive 2002/95/EC and in accordance to WEEE 2002/96/EC

RoHS
COMPLIANT

APPLICATIONS

- Solid-state relays
- Industrial controls
- Office equipment
- Consumer appliances

AGENCY APPROVALS

- UL1577, file no. E52744 system code H, double protection
- CSA 93751
- DIN EN 60747-5-2 (VDE 0884)/DIN EN 60747-5-5 (pending), available with option 1

ORDERING INFORMATION

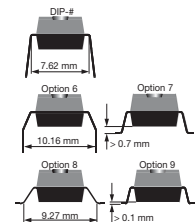
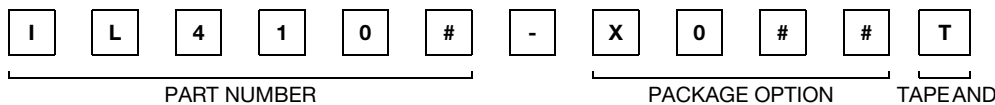

AGENCY CERTIFIED/PACKAGE	BLOCKING VOLTAGE V _{DRM} (V)	
	600	800
UL		
DIP-6	IL410	IL4108
DIP-6, 400 mil, option 6	IL410-X006	IL4108-X006
SMD-6, option 7	IL410-X007T ⁽¹⁾	IL4108-X007T ⁽¹⁾
SMD-6, option 8	IL410-X008T	-
SMD-6, option 9	IL410-X009T ⁽¹⁾	IL4108-X009T ⁽¹⁾
VDE, UL		
DIP-6	600	800
DIP-6, 400 mil, option 6	IL410-X001	IL4108-X001
SMD-6, option 7	IL410-X016	IL4108-X016
SMD-6, option 8	IL410-X017	IL4108-X017
SMD-6, option 9	IL410-X019T ⁽¹⁾	-

Note

⁽¹⁾ Also available in tubes, do not put T on the end.

IL410, IL4108



Vishay Semiconductors Optocoupler, Phototriac Output, Zero Crossing,
High dV/dt, Low Input Current

ABSOLUTE MAXIMUM RATINGS ($T_{amb} = 25\text{ }^{\circ}\text{C}$, unless otherwise specified)					
PARAMETER	TEST CONDITION	PART	SYMBOL	VALUE	UNIT
INPUT					
Reverse voltage			V_R	6	V
Forward current			I_F	60	mA
Surge current			I_{FSM}	2.5	A
Power dissipation			P_{diss}	100	mW
Derate from 25 °C				1.33	mW/°C
OUTPUT					
Peak off-state voltage		IL410	V_{DRM}	600	V
		IL4108	V_{DRM}	800	V
RMS on-state current			I_{TM}	300	mA
Single cycle surge current				3	A
Total power dissipation			P_{diss}	500	mW
Derate from 25 °C				6.6	mW/°C
COUPLER					
Isolation test voltage between emitter and detector	$t = 1\text{ s}$		V_{ISO}	5300	V_{RMS}
Pollution degree (DIN VDE 0109)				2	
Creepage distance				≥ 7	mm
Clearance distance				≥ 7	mm
Comparative tracking index per DIN IEC112/VDE 0303 part 1, group IIIa per DIN VDE 6110			CTI	≥ 175	
Isolation resistance	$V_{IO} = 500\text{ V}, T_{amb} = 25\text{ }^{\circ}\text{C}$		R_{IO}	$\geq 10^{12}$	Ω
	$V_{IO} = 500\text{ V}, T_{amb} = 100\text{ }^{\circ}\text{C}$		R_{IO}	$\geq 10^{11}$	Ω
Storage temperature range			T_{stg}	- 55 to + 150	°C
Ambient temperature			T_{amb}	- 55 to + 100	°C
Soldering temperature ⁽¹⁾	max. $\leq 10\text{ s}$ dip soldering $\geq 0.5\text{ mm}$ from case bottom		T_{sld}	260	°C

Notes

- Stresses in excess of the absolute maximum ratings can cause permanent damage to the device. Functional operation of the device is not implied at these or any other conditions in excess of those given in the operational sections of this document. Exposure to absolute maximum ratings for extended periods of the time can adversely affect reliability.

⁽¹⁾ Refer to reflow profile for soldering conditions for surface mounted devices (SMD). Refer to wave profile for soldering conditions for through hole devices (DIP).



Optocoupler, Phototriac Output, Zero Crossing, Vishay Semiconductors
High dV/dt, Low Input Current

ELECTRICAL CHARACTERISTICS (T _{amb} = 25 °C, unless otherwise specified)							
PARAMETER	TEST CONDITION	PART	SYMBOL	MIN.	TYP.	MAX.	UNIT
INPUT							
Forward voltage	I _F = 10 mA		V _F		1.16	1.35	V
Reverse current	V _R = 6 V		I _R		0.1	10	μA
Input capacitance	V _F = 0 V, f = 1 MHz		C _{IN}		25		pF
Thermal resistance, junction to ambient			R _{thja}		750		°C/W
OUTPUT							
Off-state current	V _D = V _{DRM} , T _{amb} = 100 °C, I _F = 0 mA		I _{DRM}		10	100	μA
On-state voltage	I _T = 300 mA		V _{TM}		1.7	3	V
Surge (non-repetitive), on-state current	f = 50 Hz		I _{TSM}			3	A
Trigger current 1	V _D = 5 V		I _{FT1}			2	mA
Trigger current 2	V _D = 220 V _{RMS} , f = 50 Hz, T _j = 100 °C, t _{pIF} > 10 ms		I _{FT2}			6	mA
Trigger current temp. gradient			ΔI _{FT1} /ΔT _j		7	14	μA/°C
			ΔI _{FT2} /ΔT _j		7	14	μA/°C
Inhibit voltage temp. gradient			ΔV _{DINH} /ΔT _j		- 20		mV/°C
Off-state current in inhibit state	I _F = I _{FT1} , V _D = V _{DRM}		I _{DINH}		50	200	μA
Holding current			I _H		65	500	μA
Latching current	V _T = 2.2 V		I _L			500	μA
Zero cross inhibit voltage	I _F = rated I _{FT}		V _{IH}		15	25	V
Critical rate of rise of off-state voltage	V _D = 0.67 V _{DRM} , T _j = 25 °C		dV/dt _{cr}	10 000			V/μs
	V _D = 0.67 V _{DRM} , T _j = 80 °C		dV/dt _{cr}	5000			V/μs
Critical rate of rise of voltage at current commutation	V _D = 230 V _{RMS} , I _D = 300 mA _{RMS} , T _J = 25 °C		dV/dt _{crq}		8		V/μs
	V _D = 230 V _{RMS} , I _D = 300 mA _{RMS} , T _J = 85 °C		dV/dt _{crq}		7		V/μs
Critical rate of rise of on-state current commutation	V _D = 230 V _{RMS} , I _D = 300 mA _{RMS} , T _J = 25 °C		dI/dt _{crq}		12		A/ms
Thermal resistance, junction to ambient			R _{thja}		150		°C/W
COUPLER							
Critical rate of rise of coupled input/output voltage	I _T = 0 A, V _{RM} = V _{DM} = V _{DRM}		dV _{IO} /dt	10 000			V/μs
Common mode coupling capacitance			C _{CM}		0.01		pF
Capacitance (input to output)	f = 1 MHz, V _{IO} = 0 V		C _{IO}		0.8		pF
Isolation resistance	V _{IO} = 500 V, T _{amb} = 25 °C		R _{IO}		≥ 10 ¹²		Ω
	V _{IO} = 500 V, T _{amb} = 100 °C		R _{IO}		≥ 10 ¹¹		Ω

Note

- Minimum and maximum values are testing requirements. Typical values are characteristics of the device and are the result of engineering evaluation. Typical values are for information only and are not part of the testing requirements.

SWITCHING CHARACTERISTICS (T _{amb} = 25 °C, unless otherwise specified)							
PARAMETER	TEST CONDITION	PART	SYMBOL	MIN.	TYP.	MAX.	UNIT
Turn-on time	V _{RM} = V _{DM} = V _{DRM}		t _{on}		35		μs

TYPICAL CHARACTERISTICS ($T_{amb} = 25\text{ }^{\circ}\text{C}$, unless otherwise specified)

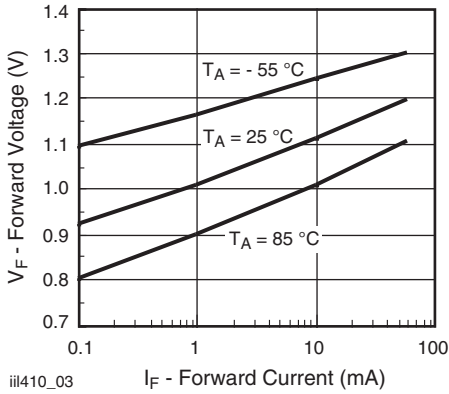

Fig. 1 - Forward Voltage vs. Forward Current

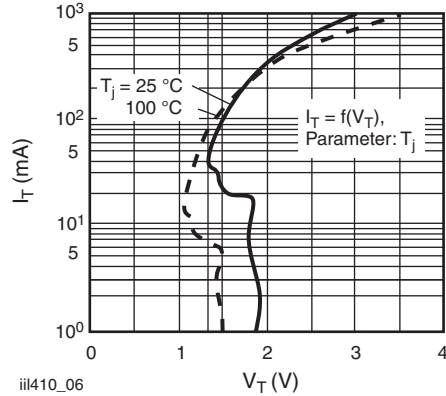

Fig. 4 - Typical Output Characteristics

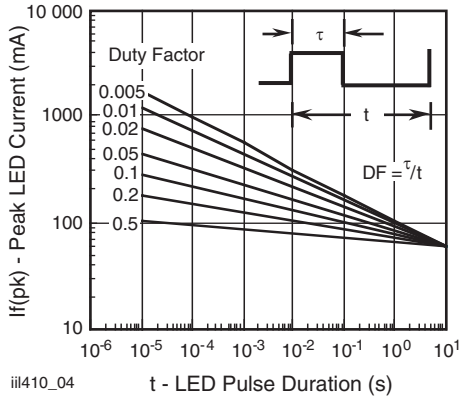

Fig. 2 - Peak LED Current vs. Duty Factor, τ

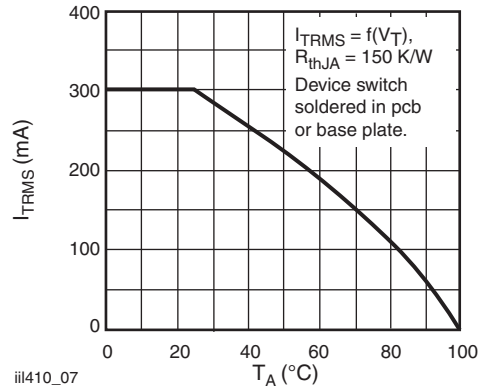

Fig. 5 - Current Reduction

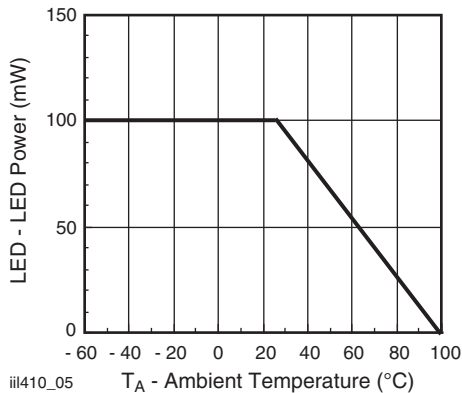

Fig. 3 - Maximum LED Power Dissipation

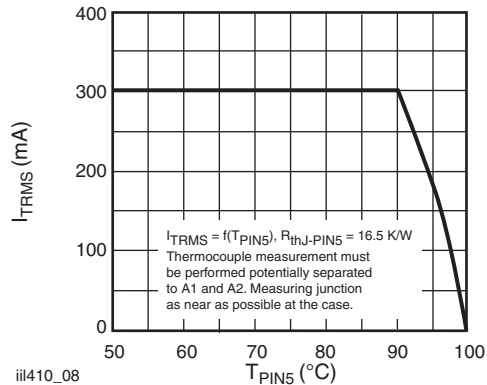

Fig. 6 - Current Reduction

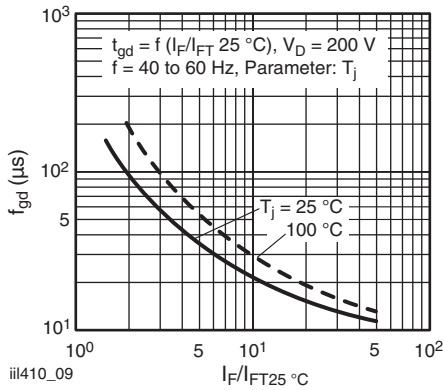

Fig. 7 - Typical Trigger Delay Time

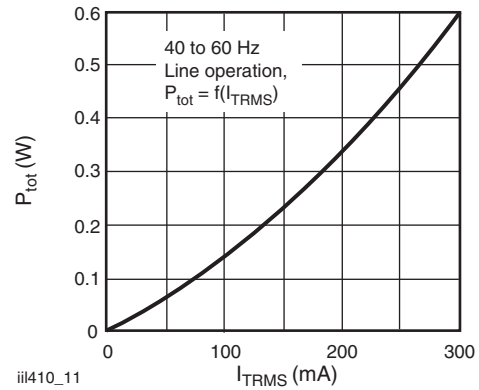

Fig. 9 - Power Dissipation 40 Hz to 60 Hz Line Operation

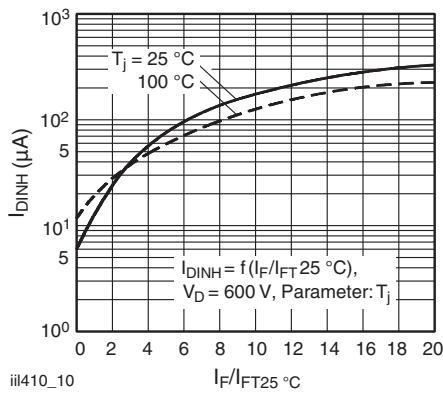

Fig. 8 - Off-State Current in Inhibited State vs. $I_F/I_{FT} 25\text{ }^\circ\text{C}$

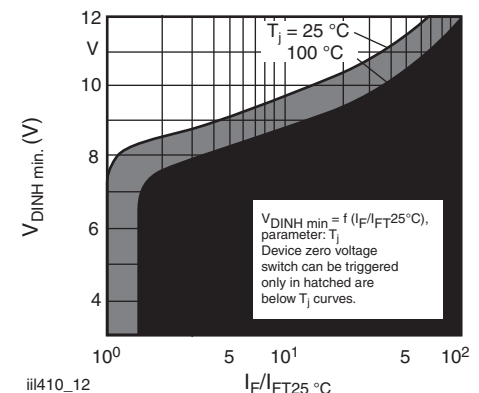

Fig. 10 - Typical Static Inhibit Voltage Limit

TRIGGER CURRENT VS. TEMPERATURE AND VOLTAGE

The trigger current of the IL410, 4108 has a positive temperature gradient and also is dependent on the terminal voltage as shown as the fig. 11.

For the operating voltage 250 V_{RMS} over the temperature range - 40 °C to 85 °C, the I_F should be at least 2.3 x of the I_{FT1} (2 mA, max.).

Considering - 30 % degradation over time, the trigger current minimum is $I_F = 2 \times 2.3 \times 130\% = 6\text{ mA}$

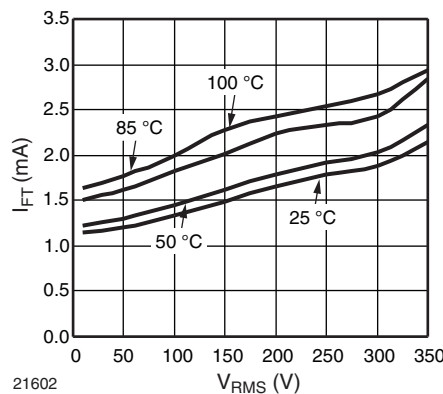

Fig. 11 - Trigger Current vs. Temperature and Operating Voltage (50 Hz)

INDUCTIVE AND RESISTIVE LOADS

For inductive loads, there is phase shift between voltage and current, shown in the fig. 12.

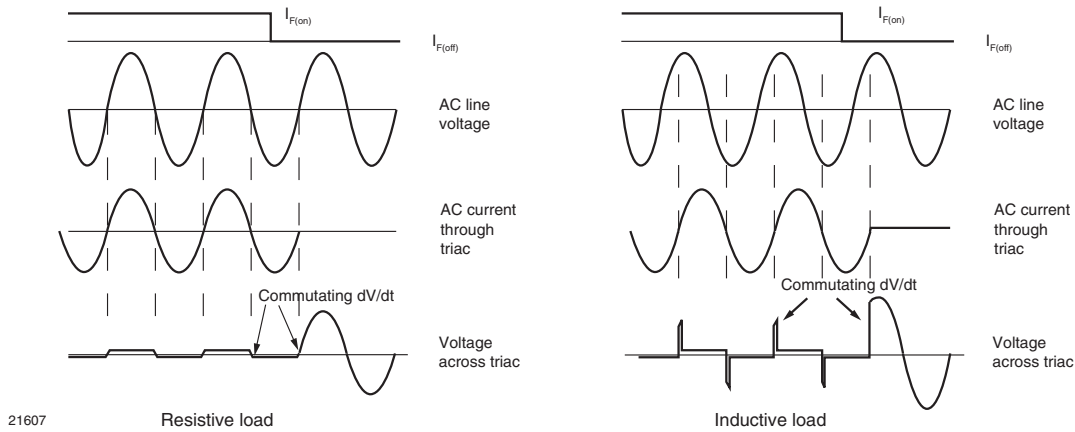

Fig. 12 - Waveforms of Resistive and Inductive Loads

The voltage across the triac will rise rapidly at the time the current through the power handling triac falls below the holding current and the triac ceases to conduct. The rise rate of voltage at the current commutation is called commutating dV/dt. There would be two potential problems for ZC phototriac control if the commutating dV/dt is too high. One is lost control to turn off, another is failed to keep the triac on.

Lost control to turn off

If the commutating dV/dt is too high, more than its critical rate (dV/dt_{crit}), the triac may resume conduction even if the LED drive current I_F is off and control is lost.

In order to achieve control with certain inductive loads of power factors is less than 0.8, the rate of rise in voltage (dV/dt) must be limited by a series RC network placed in parallel with the power handling triac. The RC network is called snubber circuit. Note that the value of the capacitor increases as a function of the load current as shown in fig. 13.

Failed to keep on

As a zero-crossing phototriac, the commutating dV/dt spikes can inhibit one half of the TRIAC from keeping on if the spike potential exceeds the inhibit voltage of the zero cross detection circuit, even if the LED drive current I_F is on.

This hold-off condition can be eliminated by using a snubber and also by providing a higher level of LED drive current. The higher LED drive provides a larger photocurrent which causes the triac to turn-on before the commutating spike has activated the zero cross detection circuit. Fig. 14 shows the relationship of the LED current for power factors of less than 1.0. The curve shows that if a device requires 1.5 mA for a resistive load, then 1.8 times (2.7 mA) that amount would be required to control an inductive load whose power factor is less than 0.3 without the snubber to dump the spike.

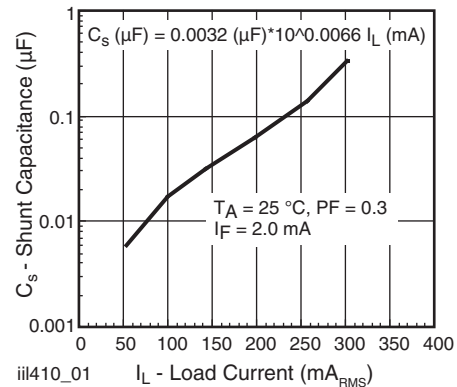

Fig. 13 - Shunt Capacitance vs. Load Current

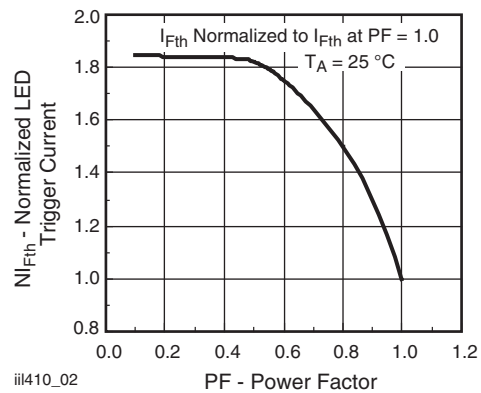

Fig. 14 - Normalized LED Trigger Current vs. Power Factor

APPLICATIONS

Direct switching operation:

The IL410, IL4108 isolated switch is mainly suited to control synchronous motors, valves, relays and solenoids. Fig. 15 shows a basic driving circuit. For resistive load the snubber circuit $R_S C_S$ can be omitted due to the high static dV/dt characteristic.

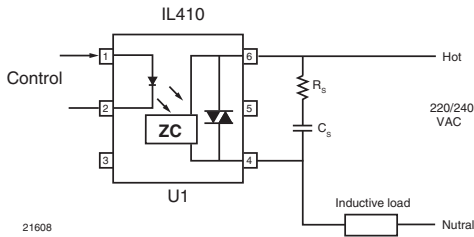

Fig. 15 - Basic Direct Load Driving Circuit

Indirect switching operation:

The IL410, IL4108 switch acts here as an isolated driver and thus enables the driving of power thyristors and power triacs by microprocessors. Fig. 16 shows a basic driving circuit of inductive load. The resistor R1 limits the driving current pulse which should not exceed the maximum permissible surge current of the IL410, IL4108. The resistor R_G is needed only for very sensitive thyristors or triacs from being triggered by noise or the inhibit current.

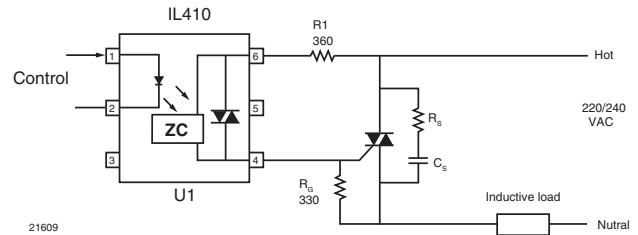
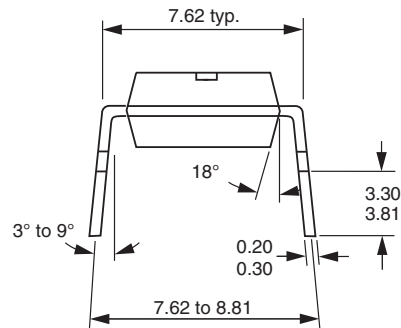
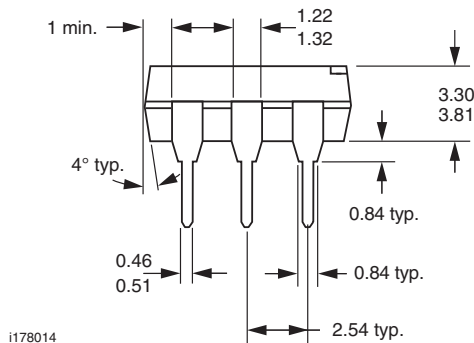
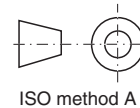
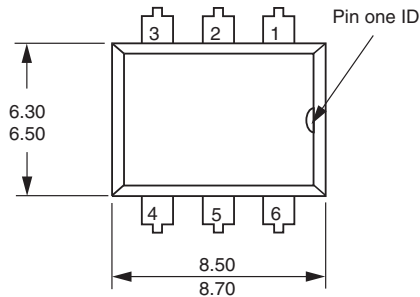

Fig. 16 - Basic Power Triac Driver Circuit

PACKAGE DIMENSIONS in millimeters



IL410, IL4108



Vishay Semiconductors Optocoupler, Phototriac Output, Zero Crossing, High dV/dt, Low Input Current

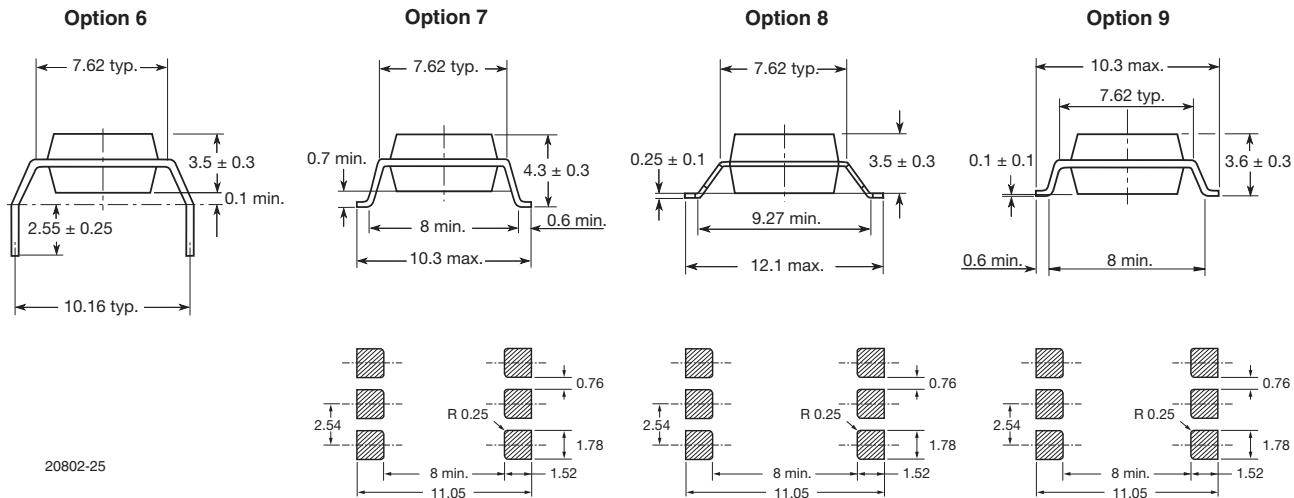

20802-25

PACKAGE MARKING (example)



Notes

- Only options 1, 7, and 8 are reflected in the package marking.
- The VDE Logo is only marked on option 1 parts.
- Tape and reel suffix (T) is not part of the package marking.



Disclaimer

ALL PRODUCT, PRODUCT SPECIFICATIONS AND DATA ARE SUBJECT TO CHANGE WITHOUT NOTICE TO IMPROVE RELIABILITY, FUNCTION OR DESIGN OR OTHERWISE.

Vishay Intertechnology, Inc., its affiliates, agents, and employees, and all persons acting on its or their behalf (collectively, "Vishay"), disclaim any and all liability for any errors, inaccuracies or incompleteness contained in any datasheet or in any other disclosure relating to any product.

Vishay makes no warranty, representation or guarantee regarding the suitability of the products for any particular purpose or the continuing production of any product. To the maximum extent permitted by applicable law, Vishay disclaims (i) any and all liability arising out of the application or use of any product, (ii) any and all liability, including without limitation special, consequential or incidental damages, and (iii) any and all implied warranties, including warranties of fitness for particular purpose, non-infringement and merchantability.

Statements regarding the suitability of products for certain types of applications are based on Vishay's knowledge of typical requirements that are often placed on Vishay products in generic applications. Such statements are not binding statements about the suitability of products for a particular application. It is the customer's responsibility to validate that a particular product with the properties described in the product specification is suitable for use in a particular application. Parameters provided in datasheets and / or specifications may vary in different applications and performance may vary over time. All operating parameters, including typical parameters, must be validated for each customer application by the customer's technical experts. Product specifications do not expand or otherwise modify Vishay's terms and conditions of purchase, including but not limited to the warranty expressed therein.

Except as expressly indicated in writing, Vishay products are not designed for use in medical, life-saving, or life-sustaining applications or for any other application in which the failure of the Vishay product could result in personal injury or death. Customers using or selling Vishay products not expressly indicated for use in such applications do so at their own risk. Please contact authorized Vishay personnel to obtain written terms and conditions regarding products designed for such applications.

No license, express or implied, by estoppel or otherwise, to any intellectual property rights is granted by this document or by any conduct of Vishay. Product names and markings noted herein may be trademarks of their respective owners.