



Chipsmall Limited consists of a professional team with an average of over 10 year of expertise in the distribution of electronic components. Based in Hongkong, we have already established firm and mutual-benefit business relationships with customers from,Europe,America and south Asia,supplying obsolete and hard-to-find components to meet their specific needs.

With the principle of “Quality Parts,Customers Priority,Honest Operation,and Considerate Service”,our business mainly focus on the distribution of electronic components. Line cards we deal with include Microchip,ALPS,ROHM,Xilinx,Pulse,ON,Everlight and Freescale. Main products comprise IC,Modules,Potentiometer,IC Socket,Relay,Connector.Our parts cover such applications as commercial,industrial, and automotives areas.

We are looking forward to setting up business relationship with you and hope to provide you with the best service and solution. Let us make a better world for our industry!



Contact us

Tel: +86-755-8981 8866 Fax: +86-755-8427 6832

Email & Skype: info@chipsmall.com Web: www.chipsmall.com

Address: A1208, Overseas Decoration Building, #122 Zhenhua RD., Futian, Shenzhen, China



Toggle Switch Boots

HEXSEAL® and E-SEEL® toggle switch boots are molded from a high tear-strength silicone rubber (other materials available for specific environments) bonded to a built-in mounting nut. Each encloses the base of the protruding switch bushing and forms a watertight and dust-tight seal against the front panel surface.

SPECIFICATIONS

Material	HEXSEALS: Silicone rubber conforms to A-A-59588, Class 3B, GR 50 (unless otherwise specified). E-SEELS: Silicone rubber polymer type ASTM D 1418
Mounting Nut	HEXSEALS: Brass, nickel-plated E-SEELS: Brass, black-oxide
Temperature Range	HEXSEALS: -94°F to +400°F (-70°C to +204°C) E-SEELS: -80°F to +400°F (-62°C to +204°C)
Enclosure Protection	NEMA/UL/ULC Types 1, 2, 3, 3S, 3R, 4, 4X, 6P, 12, 13; IEC IP66/IP68
Pressure Range	Exceeds 15 psi internal and 1500 psi external (N5032B: 10 psi)
Operational Life	100,000 actuations (minimum)
Shelf Life	Excess of 25 years
Resistant to	Salt spray, sunlight, ozone, weather, fungus, and most acids and lubricating oils
Military Specs*	Most HEXSEALS meet MIL-DTL-5423. (See listing on page 6)
Agency Recognition	UL & ULC Recognized Component to UL Std. 50
Installation	Please see installation instructions on page 19

*APM's policy is to manufacture our HEXSEAL® sealing boots as defined by the requirements of MIL-Spec MIL-DTL-5423 which we regard as the standard for the switch, circuit breaker and potentiometer industry. These requirements were formulated based on our original patent.

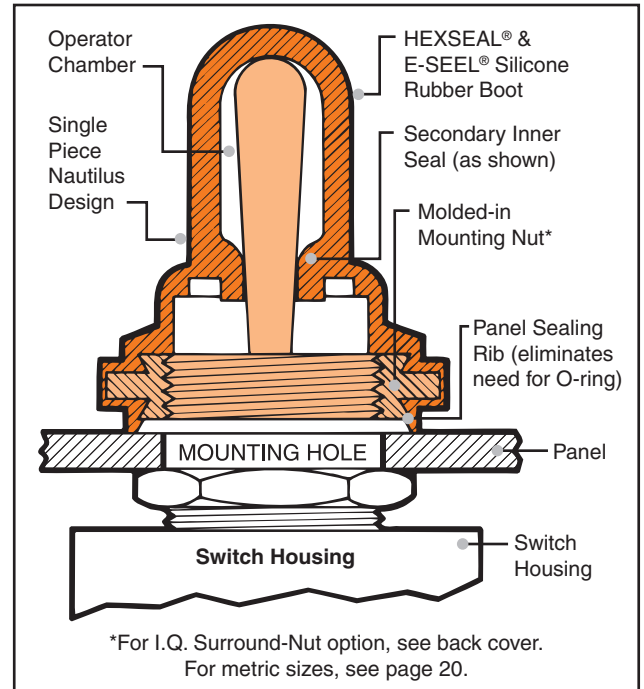

HOW TO ORDER

Specify APM boot part number and, if necessary, the appropriate bushing adaptor part number (please see page 19).



FIGURE 1 Full-Toggle Boot with Integral Secondary Inner Seal – IP66/68 Rated Figure 1

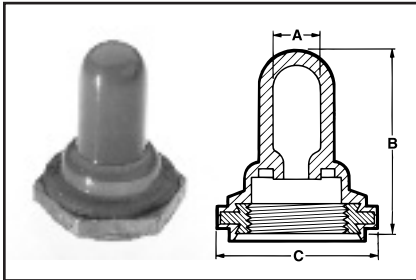

Thread Size	Max. Toggle Height Above Bushing (in.)	A Throat or I.D.		B Height		C Flat		Military Part Number	APM Boot Part Number	Color*	HEXSEAL	E-SEEL
		in.	mm	in.	mm	in.	mm					
1/4-40NS-2B	.31	.104	2.64	.422	10.72	.375	9.58	M5423/04-01	N-5030	Gray	•	
1/4-40NS-2B	.37	.062	1.53	.500	12.70	.375	9.52	M5423/05-01	N-5030L†	Gray	•	
1/4-40NS-2B	.28	.062	1.58	.390	9.91	.375	9.52	M5423/05-02	N-5030R	Gray	•	
1/4-40NS-2B	.50	.062	1.58	.594	15.08	.375	9.52	—	N-5030S	Gray	•	
1 9/32-32NS-2B	.66	.219	5.55	.844	21.44	.625	15.88	M5423/01-01	N-1030	Gray	•	
1/2-32NS-2B	.66	.219	5.55	.844	21.44	.625	15.88	—	N-1030 1/2-32	Gray	•	
1 9/32-32NS-2B	.71	.219	5.55	.937	23.81	.625	15.88	—	C1131/27	Black		•

*Other colors available. Please consult factory. †Material conforms to A-A-59588 Gr. 25

FIGURE 2 Full-Toggle Boots (with constant I.D.) – IP66/68 Rated Figure 2

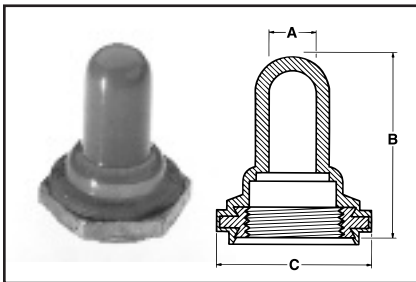

Thread Size	Max. Toggle Height Above Bushing (in.)	A Throat or I.D.		B Height		C Flat		Military Part Number	APM Boot Part Number	Color*	HEXSEAL	E-SEEL
		in.	mm	in.	mm	in.	mm					
M6 x 0.75	.37	.116	2.95	.562	14.30	.352	9.00	—	1131/25	Black	•	
1 5/32-32NS-2B	.437	.210	5.35	.625	15.88	.625	15.88	—	1131/33	Gray	•	
M12 x 1	.668	.234	5.95	.859	21.83	.625	15.88	—	1131/40	Black	•	
1 5/32-32NS-2B	.66	.219	5.55	.844	21.44	.625	15.88	—	IN-1030	Gray	•	
1 5/32-32NS-2B	.66	.256	6.50	.844	21.44	.625	15.88	—	1131/31	Gray	•	
1 5/32-32NS-2B	.90	.219	5.55	1.093	27.77	.625	15.88	—	1131/26	Gray	•	
1 5/32-32NS-2B	1.08	.390	9.92	1.328	33.37	.625	15.88	—	N-1002	Gray	•	
1 5/32-32NS-2B	.925	.300	7.62	1.110	28.19	.625	15.88	—	50154	Gray	•	
1/2-32NS-2B	.66	.219	5.55	.844	21.44	.625	15.88	—	IN-1030 1/2-32	Gray	•	
1/2-32NS-2B	.66	.256	6.50	.844	21.44	.625	15.88	—	1131/32	Black	•	
5/8-32UNS-2B	.78	.187	4.76	.844	21.44	.750	19.05	—	1131/23	Gray	•	
1 5/32-32NS-2B	.71	.219	5.55	.937	23.80	.625	15.88	—	C1131/28	Black		•

*Other colors available. Please consult factory. Mounting nut material: Aluminum

FIGURE 3 Half-Toggle Boots (toggle actuator protrudes) – IP66/68 Rated Figure 3

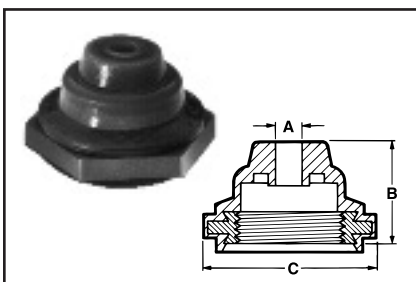

Thread Size	Toggle Diameter Accommodated (in.)	A Throat or I.D.		B Height		C Flat		Military Part Number	APM Boot Part Number	Color*	HEXSEAL	E-SEEL
		in.	mm	in.	mm	in.	mm					
1/4-40NS-2B	.062-.188	.047	1.19	.250	6.35	.375	9.53	M5423/11-01	N-5032B††	Gray	•	
1 5/32-32NS-2B	.115-.240	.109	2.77	.437	11.10	.625	15.88	M5423/02-01	N-1030B	Gray	•	
1/2-32NS-2B	.115-.240	.109	2.77	.437	11.10	.625	15.88	—	N-1030B 1/2-32	Gray	•	
1 5/32-32NS-2B	.115-.240	.109	2.77	.437	11.10	.625	15.88	—	C1132/20	Black		•

*Other colors available. Please consult factory.

DIMENSIONS FOR REFERENCE ONLY. Current dimensional drawings can be viewed on our website and CAD drawings can also be downloaded.

FIGURE 4 Armored Full Toggle Boots – IP66/68 Rated

Figure 4

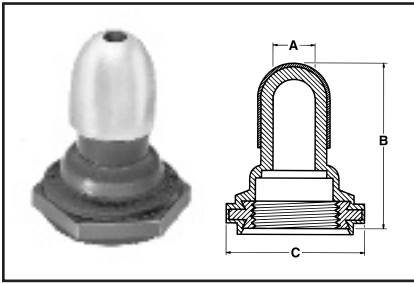

Thread Size	Max. Toggle Height Above Bushing (in.)	A Throat or I.D.		B Height		C Flat		Military Part Number	APM Boot Part Number	Color	HEXSEAL	E-SEAL
		in.	mm	in.	mm	in.	mm					
1 5/32-32NS-2B	.66	.219	5.55	.875	21.44	.625	15.88	—	N-1030A	Gray	•	

Nickel plated brass cap bonded to boot.



FIGURE 5 EMI/RFI Shielded Full Toggle Boots – IP66/68 Rated

Figure 5

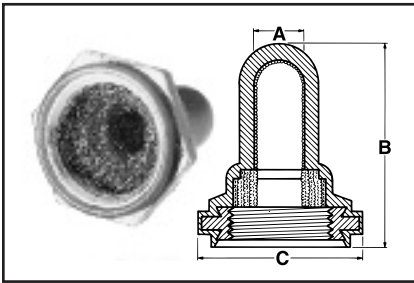

Thread Size	Max. Toggle Height Above Bushing (in.)	A Throat or I.D.		B Height		C Flat		Military Part Number	APM Boot Part Number	Color*	HEXSEAL	E-SEAL
		in.	mm	in.	mm	in.	mm					
1/4-40NS-2B	.36	.062	1.58	.500	12.70	.375	9.52	—	N-5030L RFI	Gray	•	
1 5/32-32NS-2B	.66	.219	5.55	.844	21.44	.625	15.88	M5423/01-02	IN-1030 RFI	Gray	•	
1/2-32NS-2B	.66	.219	5.55	.844	21.44	.625	15.88	—	IN-1030 RFI 1/2-32	Gray	•	
1/4-40NS-2B	.28	.062	1.58	.390	9.90	.375	9.52	—	N-5030R RFI	Gray	•	
1/4-40NS-2B	.50	.062	1.58	.594	15.08	.375	9.52	—	N-5030S RFI	Gray	•	

*Other colors available. Please consult factory.

All standard EMI/RFI boots feature a knitted Monel shield. RFI/EMI shielded boots have an operational life of 15,000 actuations (minimum)

FIGURE 5a Sealed Switch Panel Cut-Out Sealing Bushing – IP66/68 Rated

Figure 5a

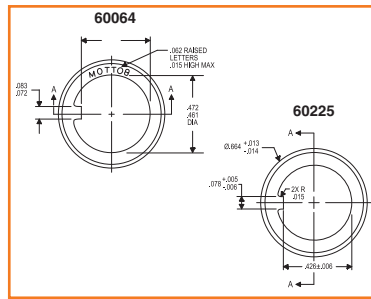

APM Part Number	Compatible Switch Bushing	Washer Diameter	Washer Thickness	Color	Conforms to*
60064	15/32-32	0.677"	0.120"	Gray	Meets MIL-B-5423/16-01, MS25196, UL & ULC Recognized Component
60225	15/32-32	0.660"	0.105"	Gray	

*APM's policy is to manufacture our HEXSEAL® sealing boots as defined by the requirements of MIL-Spec MIL-DTL-5423 which we regard as the standard for the switch, circuit breaker and potentiometer industry. These requirements were formulated based on our original patent.

SEE PAGE 16 FOR FULL DETAILS

Back-of-Panel Mounted Toggle Switch Boots

FIGURE 6 Full Toggle Boot

Figure 6

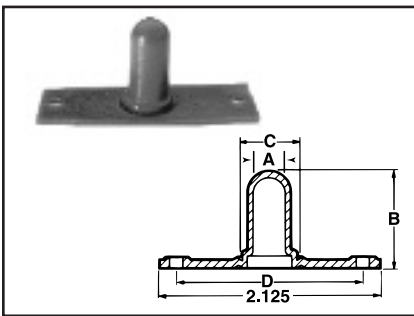

A Throat or I.D.		B Height		D Distance Between Mtg. Holes		Width		C Clearance Boot Hole Diameter		Military Part Number	APM Boot Part Number	Color*	HEXSEAL	E-SEAL
inch	mm	inch	mm	inch	mm	inch	mm	inch	mm					
.315	7.91	.938	23.82	1.813	46.04	.750	19.05	.510	12.95	—	2030	Gray	•	

*Other colors available. Please consult factory.

FIGURE 7 Half Toggle Boot (Toggle Actuator Protrudes)

Figure 7

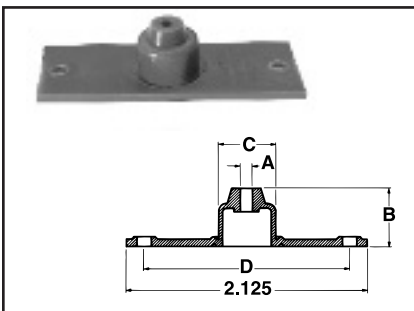

A Throat or I.D.		B Height		D Distance Between Mtg. Holes		Width		C Clearance Boot Hole Diameter		Military Part Number	APM Boot Part Number	Color*	HEXSEAL	E-SEAL
inch	mm	inch	mm	inch	mm	inch	mm	inch	mm					
.093	2.38	.500	12.70	1.813	46.04	.750	19.05	.510	12.95	M5423/03-01	2030B	Gray	•	

*Other colors available. Please consult factory.

DIMENSIONS FOR REFERENCE ONLY.

Current dimensional drawings can be viewed on our website and CAD drawings can also be downloaded.



METRIC Sizes for Toggle, Pushbutton and Rotary Switches and Circuit Breakers

SPECIFICATIONS

Material.....Silicone rubber polymer type ASTM D 1418
Mounting Nut.....Brass, black-oxide. *Brass, nickel-plated.
Temperature Range....-80°F to +400°F (-62°C to +204°C)
Enclosure Protection..NEMA/UL/ULC Types 1, 2, 3, 3S, 3R, 4, 4X, 6P, 12, 13; IEC IP66/IP68
Pressure Range.....Exceeds 15 psi internal and 1500 psi external
Operational Life.....100,000 actuations (minimum)
Shelf Life.....Excess of 25 years
Resistant to.....Salt spray, sunlight, ozone, weather, fungus, and most acids and lubricating oils
Agency Recognition...UL & ULC Recognized Component to UL Std. 50
Installation.....Please see installation instructions on page 19

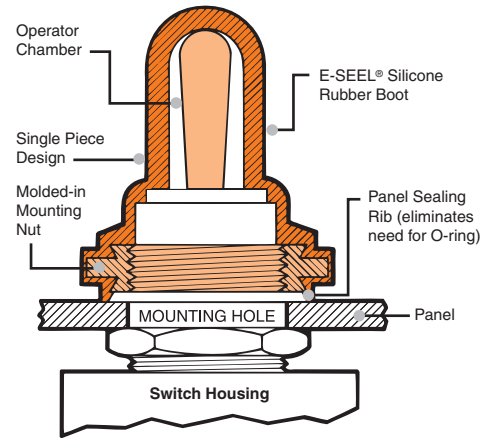

Additional metric sizes available (consult factory)

TOGGLE SWITCH BOOTS

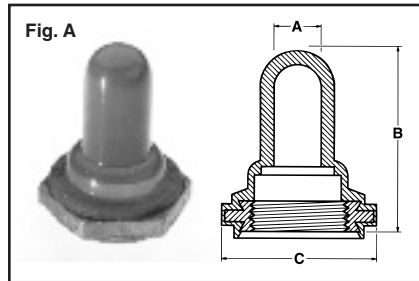

IP66/IP68/NEMA 6P Enclosure Protection

Full Toggle (with Constant I.D.) Switch Boots (covers all external portions of switch & seals switch mounting hole)

Figure A

Thread Size	Throat Size ¹ ("A")		Max Toggle Height ²		Max Boot Height ("B")		Flat ("C")		Color	APM Cat. No.
	mm	in.	mm	in.	mm	in.	mm	in.		
M6 X 0.75	2.9	0.116	10.8	0.43	14.3	0.562	9.0	0.352	Black	1131/25*
M12 X 0.75	5.3	0.21	16.2	0.64	21.6	0.85	15.8	0.625	Black	C1131/41
M12 X 0.75	5.5	0.219	22.8	0.90	27.7	1.1	15.8	0.625	Black	1131/26-M12-.75
M12 X 1	6.5	0.256	16.7	0.66	21.4	0.844	15.8	0.625	Black	1131/31-M12
M12 X 1	5.9	0.234	16.9	0.66	21.8	0.859	15.8	0.625	Black	1131/40
M12 X 1	5.5	0.219	22.8	0.90	27.7	1.1	15.8	0.625	Black	1131/26-M12-.10

¹ Throat size is the maximum diameter of the switch toggle/handle (Dimension "A").

² Max toggle height is the maximum distance from the end of the switch mounting stem to the end of the switch toggle.

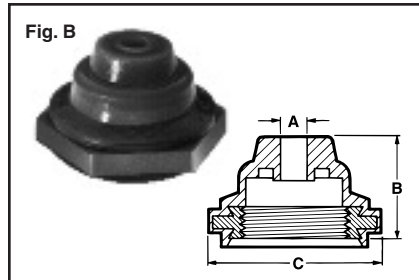

IP66/IP68/NEMA 6P Enclosure Protection

Half Toggle Switch Boots (Seals switch mounting stem & hole; toggle actuator protrudes)

Figure B

Thread Size	Throat Size ("A")		Toggle Diameter Accomodated		Max Boot Height ("B")		Flat ("C")		Color	APM Cat. No.
	mm	in.	mm	in.	mm	in.	mm	in.		
M5 X 0.5	1.1	0.42	1.57-4.57	0.062-0.18	5.7	0.225/0.25	7.9	0.313	Black	1132/17-M5-5
M12 X 1	2.36	0.093	2.92-6.09	0.115-0.24	11.1	0.437	15.9	0.625	Black	1132/33-M12-1

PUSHBUTTON SWITCHES & CIRCUIT BREAKERS/PROTECTORS

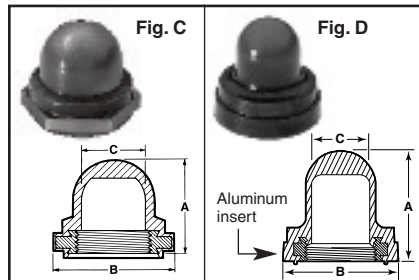

IP66/IP68/NEMA 6P Enclosure Protection

Half Toggle Switch Boots (Seals switch mounting stem & hole; toggle actuator protrudes)

Figures C & D

Thread Size ¹	Max Boot Height ("A")		Max Plunger Height		Dimension "B"		Max Plunger Diameter ("C")		Color ¹	APM Cat. No.	Fig.
	mm	in.	mm	in.	mm	in.	mm	in.			
M10 X 1	15.47	0.62	8.4	0.33	16.3	0.64	8.1	0.32	Black	C1221/21	D
M11 X 1	15.47	0.62	11.9	0.469	18.3	0.72	10.72	0.422	Clear	C1221/27	D
M12 X 1	18.64	0.47	11.9	0.469	15.9	0.625	10.72	0.422	Black	NC3030H-M12-1	C

¹ "Clear" allows viewing of breaker amp rating and trip state; please enquire for other available colors.

ROTARY SHAFT SEALS

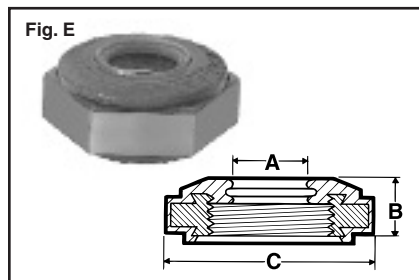

IP66/IP68/NEMA 6P Enclosure Protection

Seal the shaft and mounting hole of standard rotary switches/potentiometers that use a threaded stem and nut mounting.

Figure E

Thread Size	Shaft Size ¹ ("A")		Height ("B")		Flat ("C")		Color ²	APM Cat. No.
	mm	in.	mm	in.	mm	in.		
M7 X 0.75	5.0	0.2	5.5	0.2	12.7	0.500	Gray	1332/39-2*
M9 X 0.75	6.35	0.250	5.56	0.219	12.7	0.500	Gray	C1332/41*
M10 X 1	6.0	0.236	5.9	0.236	12.7	0.500	Gray	1332/45*

¹ Switch/potentiometer shaft must have a smooth, round cross-section where it meets the sealing edge of the shaft seal device.

² Please enquire for other available colors.