



Chipsmall Limited consists of a professional team with an average of over 10 year of expertise in the distribution of electronic components. Based in Hongkong, we have already established firm and mutual-benefit business relationships with customers from,Europe,America and south Asia,supplying obsolete and hard-to-find components to meet their specific needs.

With the principle of "Quality Parts,Customers Priority,Honest Operation,and Considerate Service",our business mainly focus on the distribution of electronic components. Line cards we deal with include Microchip,ALPS,ROHM,Xilinx,Pulse,ON,Everlight and Freescale. Main products comprise IC,Modules,Potentiometer,IC Socket,Relay,Connector.Our parts cover such applications as commercial,industrial, and automotives areas.

We are looking forward to setting up business relationship with you and hope to provide you with the best service and solution. Let us make a better world for our industry!



## Contact us

Tel: +86-755-8981 8866 Fax: +86-755-8427 6832

Email & Skype: info@chipsmall.com Web: www.chipsmall.com

Address: A1208, Overseas Decoration Building, #122 Zhenhua RD., Futian, Shenzhen, China



# IND033 Hornet: Non-Isolated DC-DC Voltage Regulator Modules

12Vdc input; 0.8Vdc to 5.5Vdc output; 33W Max Power



### Applications

- ✓ Industrial Equipment
- ✓ Control Boards
- ✓ Test Equipment

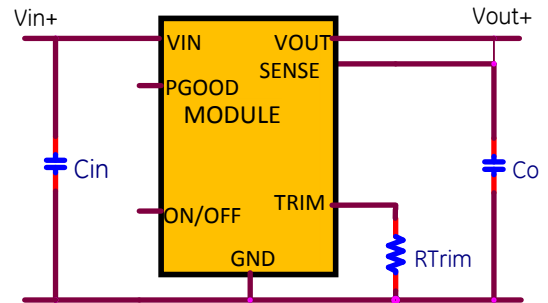

### Electrical Features

- 12V Input voltage with up to ±20% Tolerance
- Output voltage programmable from 0.8Vdc to 5.5Vdc via external resistor
- Remote On/Off for optional external control
- Power Good signal for external monitoring
- Fixed switching frequency
- Output overcurrent protection (non-latching)

### Mechanical Features

- Small size: 12.2 mm x 12.2 mm x 7.25 mm (0.48 in x 0.48 in x 0.29 in)
- Operating range: -40°C to 105°C ambient
- Operating shock to 40G per Mil Std. 810F, Method 516.4 Procedure I
- Operating vibration per Mil Std. 810F, Method 514.5 Procedure I

### Process and Safety

- Qualified for 1000h High Temperature Operating Bias, 1000h 85RH/85°C Temperature, Humidity and Bias, 700 cycle -40 to 125°C thermal cycling
- ANSI/UL# 60950-1 2<sup>nd</sup> Revised October 14, 2014, CSA† C22.2 No. 60950-1-07, Second Ed. + A2:2014 (MOD) Recognized, DIN EN 60950-1:2006 + A11:2009 + A1:2010 +A12:2011, + A2:2013 (VDE‡ 0805-1) Licensed
- ISO\*\* 9001 and ISO 14001 certified manufacturing facilities
- Compliant to RoHS II EU "Directive 2011/65/EU"
- Compatible in a Pb-free or SnPb reflow environment.
- Suitable for aqueous clean.
- Suitable for conformal coating with dip and vapor deposition. Conformal coating can provide the protection to meet Salt Fog Test per IEC 60068-2-52 (Severity 3) and Mixed Gas Flow test per Telcordia GR-3108 Outdoor Levels.
- 3 year warranty

Device Code	Input Voltage	Output Voltage	Output Current (Max.)	On/Off Logic	Comcode
IND033	9.6 – 14.4**Vdc	0.8 – 5.5Vdc	6A	Negative	1600102898A

### Thermal Performance

Full rated output with natural convection up to 100°C at 1.2Vout and up to 90°C at 5Vout. Thermal curves for 1.2V, 1.8V and 5Vout below.

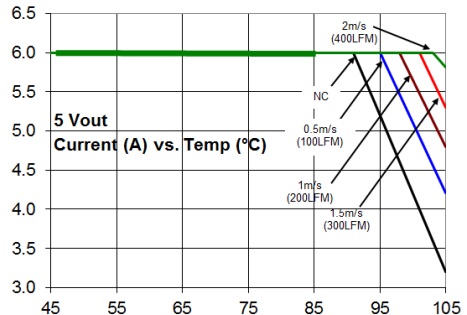
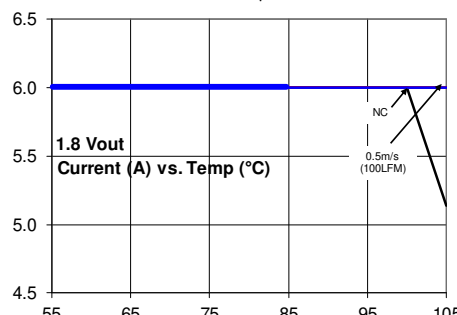
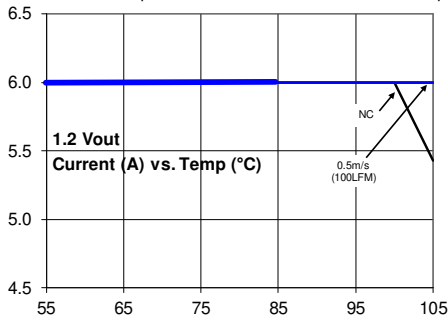

**Electrical Specifications**

Parameter	Device	Symbol	Min	Typ	Max	Unit
Operating Input Voltage	All	V <sub>IN</sub>	9.6	12	14.4**	Vdc
Input No Load Current (V <sub>IN</sub> = 12.0Vdc, I <sub>O</sub> = 0, module enabled)	V <sub>O,set</sub> = 5Vdc	I <sub>IN,No load</sub>		55		mA
External Capacitance, Ceramic ESR ≥ 1 mΩ	All	C <sub>O,max</sub>	10	—	22*	μF
Efficiency 12V <sub>INDC</sub> , T <sub>A</sub> =25°C, I=12A, V <sub>O</sub> =1.2 to 5Vdc		η	86(1.2V), 89(1.8V), 93(3.3V), 94(5V)			%
Switching Frequency	All	f <sub>sw</sub>	—	600	—	kHz
Output Voltage (Over all line, load, and temperature conditions until end of life)	All	V <sub>O, set</sub>	-3.0	—	+3.0	% V <sub>O, set</sub>
On/Off Logic High (MODULE OFF) Input High Voltage	All	V <sub>IH</sub>	3.0	—	14.4	Vdc
On/ Off Logic Low (MODULE ON) Input Low Voltage	All	V <sub>IL</sub>	-0.2	—	0.4	Vdc
PGOOD (Power Good) <b>Signal Interface Open Drain, V<sub>supply</sub> ≤ 5VDC</b>						
Overvoltage threshold for PGOOD				112.5		%V <sub>O, set</sub>
Undervoltage threshold for PGOOD				87.5		%V <sub>O, set</sub>
Pulldown resistance of PGOOD pin	All			30		Ω
Sink current capability into PGOOD pin	All				5	mA

\*Additional External Capacitance possible using Tunable Loop

\*\* For 0.8≤V<sub>out</sub><1, do not exceed 12V<sub>in</sub>. For 1≤V<sub>out</sub><1.2, do not exceed 13V<sub>in</sub>. For V<sub>out</sub>≥1.2, Input Voltage can be as high as 14.4V

**Characteristic Curves**

The following figures provide typical characteristics for the IND033 Hornet at 25°C.

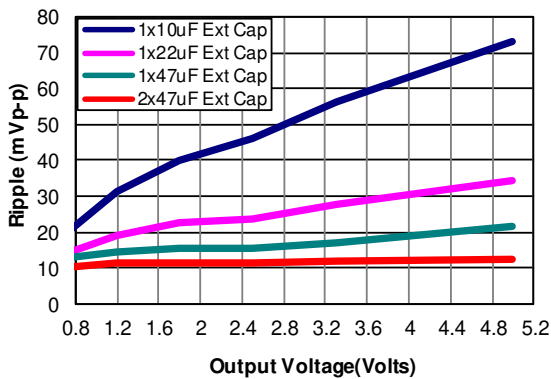

Figure 1. Output Ripple Voltage (20MHz BW) for various output voltages and external caps @12Vin. Additional Decoupling cap of 0.1uF used on input and output side

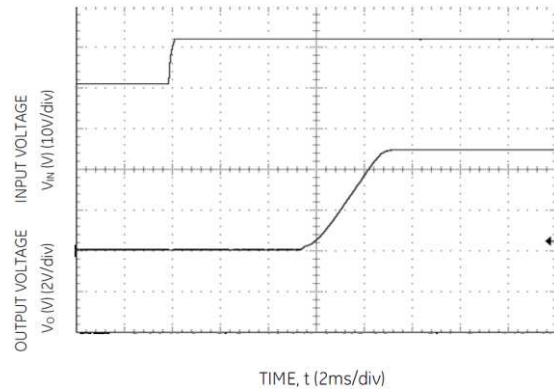

Figure 2. Typical Start-up using Input Voltage (Vin=12V, Vout = Vout, max, Iout = Iout, max)

**Trim**

Without an external resistor between Trim and GND pins, the output of the module will be 0.6Vdc. R<sub>trim</sub> for a desired output voltage, should be as per the following table. The formula in the last column helps determine R<sub>trim</sub> for other voltages.

V <sub>O</sub> (V)	0.9	1.2	1.5	1.8	2.5	3.3	5.0	$R_{trim} = \left[ \frac{12}{(V_o - 0.6)} \right] k\Omega$
R <sub>trim</sub> (kΩ)	40	20	13.3	10	6.316	4.4	2.727	

**Safety Considerations**

For safety agency approval, the power module must be installed in compliance with the spacing and separation requirements of the end-use safety agency standards listed on the first page of this document. For the converter output to be considered meeting the requirements of safety extra-low voltage (SELV), the input must meet SELV requirements. The power module has extra-low voltage (ELV) outputs when all inputs are ELV. The input to these units is to be provided with a fast-acting fuse with a maximum rating of 10A, 125VDC in the positive input lead.

**Tunable Loop**

The module is designed for 1x22uF capacitor on its output. For applications where more than 1x22uF capacitors would be used on the output, an additional Resistor (Rtune) and Capacitor (Ctune) would be required in the circuit schematic to compensate for the additional capacitance. The placement is between the Sense+ pin and Trim pin as per figure below:

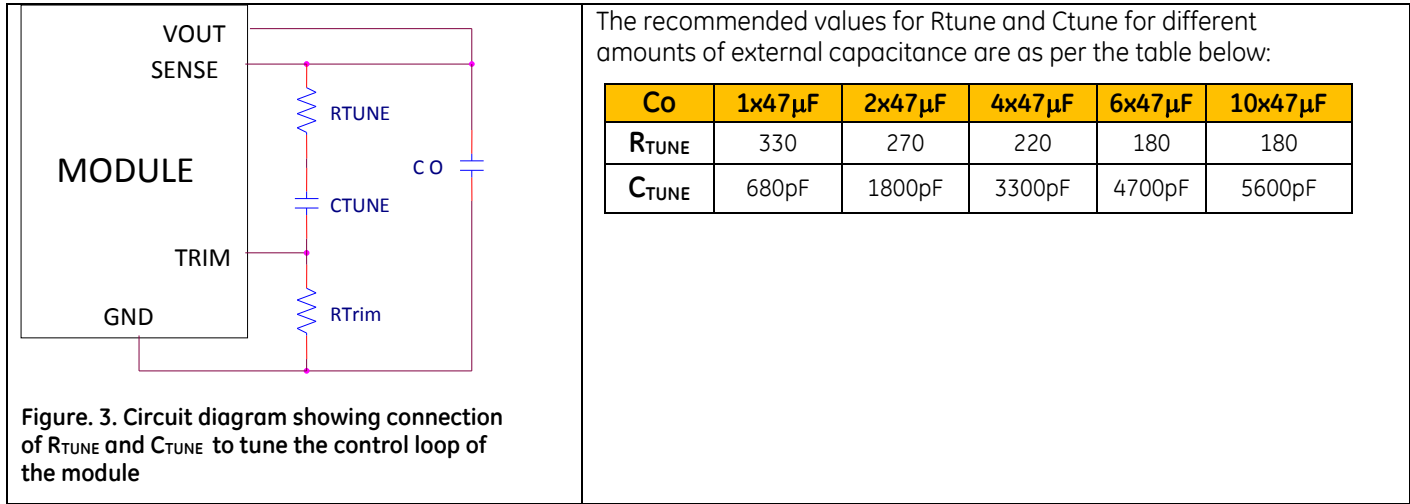

Figure. 3. Circuit diagram showing connection of RTUNE and CTUNE to tune the control loop of the module

**PowerGood (PGOOD)**

This is an open-drain output to indicate that the output voltage is within the regulation limits of the module. The PGOOD signal will be de-asserted to a low state if any condition such as overtemperature, overcurrent or loss of regulation occurs that would result in the output voltage going ±10% outside the setpoint value. If not used, leave unconnected.

**Recommended Pad Layout**

Dimensions are in millimeters and (inches).

Tolerances: x.x mm ± 0.5 mm (x.xx in. ± 0.02 in.) [unless otherwise indicated] x.xx mm ± 0.25 mm (x.xxx in ± 0.010 in.)

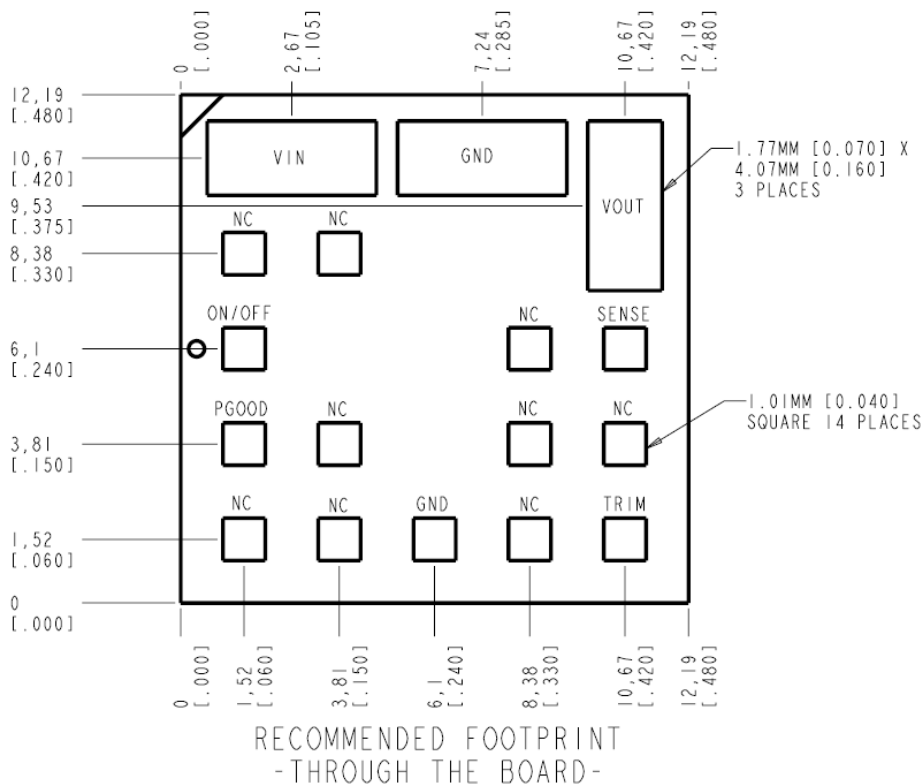

## Nozzle Recommendations

The minimum recommended inside nozzle diameter for reliable operation is 3mm. The maximum nozzle outer diameter, which will safely fit within the allowable component spacing, is 7 mm.

## Bottom Side / First Side Assembly

This module is not recommended for assembly on the bottom side of a customer board. If such an assembly is attempted, components may fall off the module during the second reflow process

## Lead Free Soldering

The modules are lead-free (Pb-free) and RoHS compliant and fully compatible in a Pb-free soldering process. Failure to observe the instructions below may result in the failure of or cause damage to the modules and can adversely affect long-term reliability

## MSL Rating

The modules have a MSL rating of 2a.

## Pb-free Reflow Profile

Power Systems will comply with J-STD-020 Rev. D (Moisture/Reflow Sensitivity Classification for Nonhermetic Solid State Surface Mount Devices) for both Pb-free solder profiles and MSL classification procedures. The suggested Pb-free solder paste is Sn/Ag/Cu (SAC).

The following profile is the recommended linear reflow profile using Sn/Ag/Cu solder. Soldering outside of the recommended profile requires testing to verify results and performance.

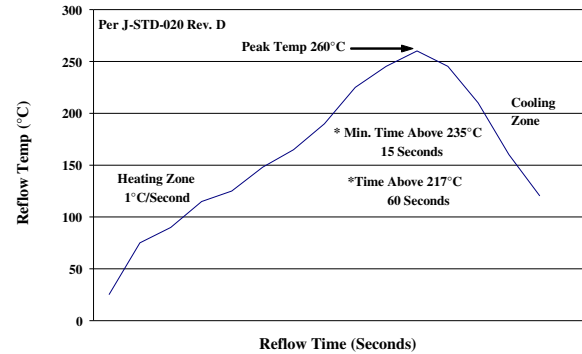

## Storage and Handling

J-STD-033 Rev. A (Handling, Packing, Shipping and Use of Moisture/Reflow Sensitive Surface Mount Devices) is recommended. Moisture barrier bags (MBB) with desiccant are required for MSL ratings of 2 or greater. These sealed packages should not be broken until time of use. Once the original package is broken, the floor life of the product at conditions of  $\leq 30^{\circ}\text{C}$  and 60% relative humidity varies according to the MSL rating (see J-STD-033A). The shelf life for dry packed SMT packages will be a minimum of 12 months from the bag seal date, when stored at the following conditions:  $< 40^{\circ}\text{C}$ ,  $< 90\%$  relative humidity.

## Post Solder Cleaning and Drying Considerations

Post solder cleaning is usually the final circuit-board assembly process prior to electrical board testing. The result of inadequate cleaning and drying can affect both the reliability of a power module and the testability of the finished circuit-board assembly

## Contact Us

For more information, call us at

USA/Canada:

**+1 888 546 3243**, or +1 972 244 9288

Asia-Pacific:

+86.021.54279977\*808

Europe, Middle-East and Africa:

+49.89.878067-280

[www.gecriticalpower.com](http://www.gecriticalpower.com)



GE Critical Power reserves the right to make changes to the product(s) or information contained herein without notice, and no liability is assumed as a result of their use or application. No rights under any patent accompany the sale of any such product(s) or information.