



Chipsmall Limited consists of a professional team with an average of over 10 year of expertise in the distribution of electronic components. Based in Hongkong, we have already established firm and mutual-benefit business relationships with customers from,Europe,America and south Asia,supplying obsolete and hard-to-find components to meet their specific needs.

With the principle of “Quality Parts,Customers Priority,Honest Operation,and Considerate Service”,our business mainly focus on the distribution of electronic components. Line cards we deal with include Microchip,ALPS,ROHM,Xilinx,Pulse,ON,Everlight and Freescale. Main products comprise IC,Modules,Potentiometer,IC Socket,Relay,Connector.Our parts cover such applications as commercial,industrial, and automotives areas.

We are looking forward to setting up business relationship with you and hope to provide you with the best service and solution. Let us make a better world for our industry!



## Contact us

Tel: +86-755-8981 8866 Fax: +86-755-8427 6832

Email & Skype: info@chipsmall.com Web: www.chipsmall.com

Address: A1208, Overseas Decoration Building, #122 Zhenhua RD., Futian, Shenzhen, China



## Important notice

Dear Customer,

On 7 February 2017 the former NXP Standard Product business became a new company with the tradename **Nexperia**. Nexperia is an industry leading supplier of Discrete, Logic and PowerMOS semiconductors with its focus on the automotive, industrial, computing, consumer and wearable application markets

In data sheets and application notes which still contain NXP or Philips Semiconductors references, use the references to Nexperia, as shown below.

Instead of <http://www.nxp.com>, <http://www.philips.com/> or <http://www.semiconductors.philips.com/>, use <http://www.nexperia.com>

Instead of [sales.addresses@www.nxp.com](mailto:sales.addresses@www.nxp.com) or [sales.addresses@www.semiconductors.philips.com](mailto:sales.addresses@www.semiconductors.philips.com), use [salesaddresses@nexperia.com](mailto:salesaddresses@nexperia.com) (email)

Replace the copyright notice at the bottom of each page or elsewhere in the document, depending on the version, as shown below:

- © NXP N.V. (year). All rights reserved or © Koninklijke Philips Electronics N.V. (year). All rights reserved

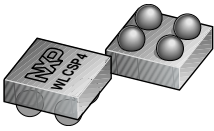
Should be replaced with:

- © **Nexperia B.V. (year). All rights reserved.**

If you have any questions related to the data sheet, please contact our nearest sales office via e-mail or telephone (details via [salesaddresses@nexperia.com](mailto:salesaddresses@nexperia.com)). Thank you for your cooperation and understanding,

Kind regards,

Team Nexperia



# IP4085CX4; IP4385CX4; IP4386CX4; IP4387CX4

Integrated high-performance ESD protection diodes

Rev. 2 — 14 December 2012

Product data sheet

## 1. Product profile

---

### 1.1 General description

Integrated high-performance protection diodes protecting appliances against ElectroStatic Discharge (ESD) of  $\pm 30$  kV, far exceeding IEC 61000-4-2 level 4 standard, overvoltage and wrong polarity.

Each device includes one high-level ESD protection diode in a 4-channel 0.4 mm (IP438xCX4) or 0.5 mm (IP4085CX4) pitch Wafer Level Chip-Size Package (WLCSP). The anode and the cathode of ESD protection diode are each connected to two solder balls.

### 1.2 Features and benefits

- Single integrated high-performance ESD protection diode
- Surge immunity according to IEC 61000-4-5 (8/20  $\mu$ s) up to 60 A (IP4085CX4)
- ESD protection of >30 kV contact discharge, far exceeding IEC 61000-4-2, level 4
- Small 2 × 2 solder ball WLCSP package with 0.4 mm or 0.5 mm pitch

### 1.3 Applications

General-purpose ESD protection such as for charger interfaces in:

- Mobile handsets
- Portable devices
- Wireless data systems



## 2. Pinning information

**Table 1. Pinning**

Pin	Description	Simplified outline	Graphic symbol
A1 and A2	cathode	<p>008aaa236</p> <p>transparent top view, solder balls facing down</p>	<p>006aad220</p>
B1 and B2	anode		

## 3. Ordering information

**Table 2. Ordering information**

Type number	Package		Version
	Name	Description	
IP4085CX4/LF/P	WLCSP4	wafer level chip-size package: 4 bumps (2 × 2) <sup>[1]</sup>	IP4085CX4/LF/P
IP4385CX4/LF		wafer level chip-size package: 4 bumps (2 × 2) <sup>[2]</sup>	IP4385CX4/LF
IP4386CX4/P			IP4386CX4/P
IP4387CX4/P			IP4387CX4/P

[1] Size: 0.91 × 0.91 × 0.65 mm

[2] Size: 0.76 × 0.76 × 0.61 mm

## 4. Limiting values

**Table 3. Limiting values**
*In accordance with the Absolute Maximum Rating System (IEC 60134).*

Symbol	Parameter	Conditions	Min	Max	Unit
V <sub>RWM</sub>	reverse standoff voltage	IP4085CX4; IP4386CX4	-0.5	+14	V
		IP4385CX4	-0.5	+5.5	V
		IP4387CX4	-0.5	+8.0	V
V <sub>ESD</sub>	electrostatic discharge voltage	all pins to ground			
		contact discharge	[1] -30	+30	kV
		air discharge	[1] -15	+15	kV
		IEC 61000-4-2, level 4; all pins to ground			
		contact discharge	-8	+8	kV
	air discharge	-15	+15	kV	
I <sub>PP</sub>	peak pulse current	IEC 61000-4-5; t <sub>p</sub> = 8/20 μs			
		IP4085CX4	60	-	A
		IP4385CX4; IP4387CX4	33	-	A
		IP4386CX4	28	-	A
I <sub>FSM</sub>	non-repetitive peak forward current	10 pulses; 1 pulse per second			
		IP4085CX4; IP4386CX4; t <sub>p</sub> = 2 ms	10	-	A
		IP4085CX4; IP4386CX4; t <sub>p</sub> = 5 ms	8.5	-	A
		IP4085CX4; IP4386CX4; t <sub>p</sub> = 100 ms	3.5	-	A
		IP4385CX4; IP4387CX4; t <sub>p</sub> = 2 ms	11	-	A
		IP4385CX4; IP4387CX4; t <sub>p</sub> = 5 ms	9	-	A
		IP4385CX4; IP4387CX4; t <sub>p</sub> = 100 ms	5	-	A
P <sub>tot</sub>	total power dissipation	forward conducting	[2]		
		IP4085CX4	[3] -	1	W
		IP4385CX4; IP4386CX4; IP4387CX4	[3] -	0.7	W
T <sub>stg</sub>	storage temperature		-55	+150	°C
T <sub>reflow(peak)</sub>	peak reflow temperature	t <sub>p</sub> ≤ 10 s	-	260	°C
T <sub>amb</sub>	ambient temperature		-30	+85	°C

[1] Device tested with over 1000 pulses of ±30 kV contact discharges, according to the IEC 61000-4-2 model.

[2] Severe self-heating demands a heat-dissipation optimized Printed-Circuit Board (PCB) to prevent the device from de-soldering. For ambient temperature above 50 °C, the guaranteed life time is 48 hours at 0.7 W, assuming R<sub>th</sub> to be 130 K/W as specified in [Table 4](#).

[3] Permanent operation at maximum power dissipation and above maximum junction temperature will result in a reduced life time.

## 5. Thermal characteristics

**Table 4. Thermal characteristics**

Symbol	Parameter	Conditions	Typ	Unit
$R_{th(j-a)}$	thermal resistance from junction to ambient	on a 2-layer PCB	[1] 130	K/W

[1] Depends on details of PCB layout.

## 6. Characteristics

**Table 5. Electrical characteristics**

$T_{amb} = 25\text{ °C}$ ; unless otherwise specified.

Symbol	Parameter	Conditions	Min	Typ	Max	Unit
$V_{BR}$	breakdown voltage	$I_R = 15\text{ mA}$				
		IP4085CX4; IP4386CX4	16	-	-	V
		IP4385CX4	7.0	-	-	V
		IP4387CX4	10	-	-	V
$V_{CL}$	clamping voltage	$I_R = 1\text{ A}$ ; $T_{amb} \leq 85\text{ °C}$ at surge peak pulse, according to IEC 61000-4-5				
		IP4085CX4	-	-	20	V
		IP4385CX4	-	-	10	V
		IP4386CX4	-	-	20	V
$I_{RM}$	reverse leakage current	IP4085CX4; IP4385CX4 $V_R = +5\text{ V}$	-	-	200	nA
		IP4386CX4; $V_R = +14\text{ V}$	-	-	200	nA
		IP4387CX4; $V_R = +8\text{ V}$	-	-	800	nA
$C_d$	diode capacitance	$V_R = 0\text{ V}$ ; $f = 1\text{ MHz}$				
		IP4085CX4	-	180	-	pF
		IP4385CX4	-	450	-	pF
		IP4386CX4	-	160	-	pF
$V_F$	forward voltage	$I_F = 850\text{ mA}$				
		IP4085CX4	[1] -	-	1.15	V
			[2] -	-	1.3	V
		IP4385CX4	[1] -	-	1.0	V
			[2] -	-	1.1	V
		IP4386CX4	[1] -	-	1.15	V
			[2] -	-	1.3	V
		IP4387CX4	[1] -	-	1.10	V
[2] -	-		1.25	V		

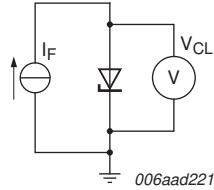
[1]  $T_{amb} \geq +25\text{ °C}$

[2]  $-30\text{ °C} \leq T_{amb} \leq +85\text{ °C}$

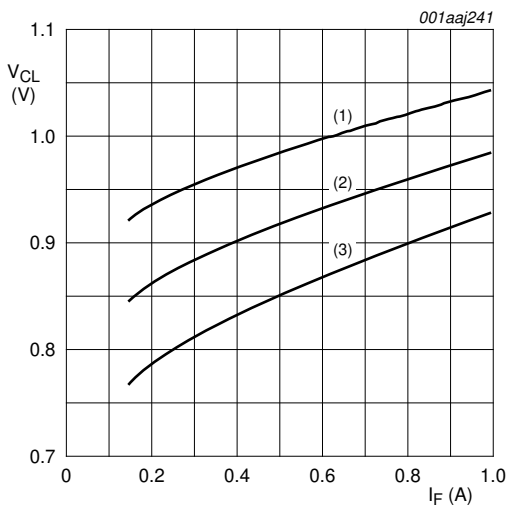
## 7. Application information

### 7.1 Forward current DC clamping voltage

The forward current DC clamping voltage is an indicator of protection level of circuit from voltage sources with the wrong polarity. [Figure 1](#) shows basic measurement setup.

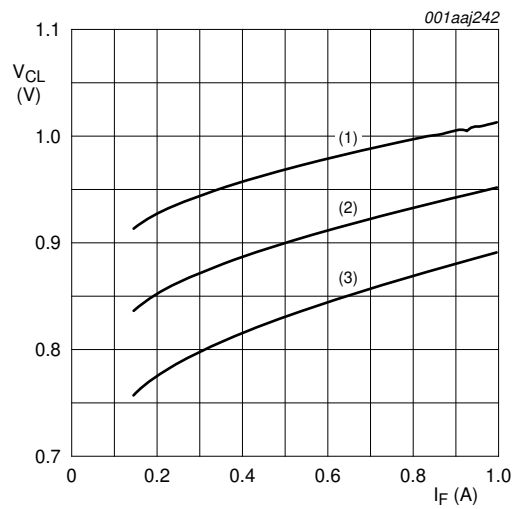


**Fig 1. Measuring DC clamping voltage with forward current**



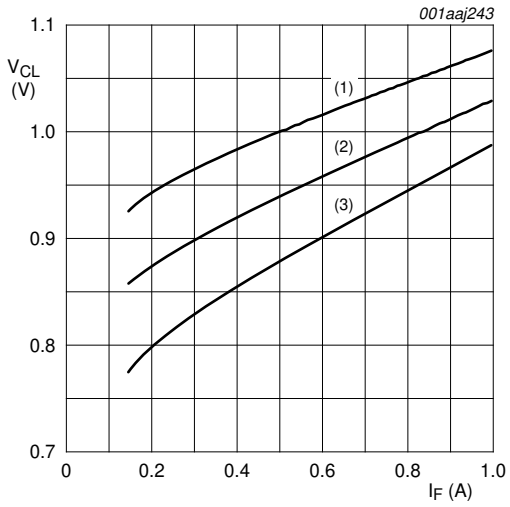
- (1)  $T_{amb} = +25\text{ °C}$
- (2)  $T_{amb} = +85\text{ °C}$
- (3)  $T_{amb} = -30\text{ °C}$

**Fig 2. IP4085CX4: DC clamping voltage as a function of forward current**



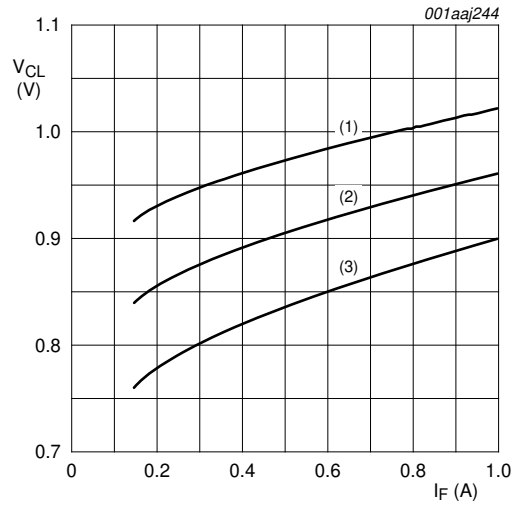
- (1)  $T_{amb} = +25\text{ °C}$
- (2)  $T_{amb} = +85\text{ °C}$
- (3)  $T_{amb} = -30\text{ °C}$

**Fig 3. IP4385CX4: DC clamping voltage as a function of forward current**



- (1)  $T_{amb} = +25\text{ °C}$
- (2)  $T_{amb} = +85\text{ °C}$
- (3)  $T_{amb} = -30\text{ °C}$

**Fig 4. IP4386CX4: DC clamping voltage as a function of forward current**



- (1)  $T_{amb} = +25\text{ °C}$
- (2)  $T_{amb} = +85\text{ °C}$
- (3)  $T_{amb} = -30\text{ °C}$

**Fig 5. IP4387CX4: DC clamping voltage as a function of forward current**



### 7.2 Peak clamping voltage

The peak clamping voltage for forward and reverse current pulses of 8/20  $\mu\text{s}$  (IEC 61000-4-5) is an indicator of protection level of circuits from power surges due to voltage discharges. The current pulse shape over time is shown in [Figure 7](#). The basic measurement setup for forward current and reverse current pulses respectively are shown in [Figure 6](#) and [Figure 12](#).

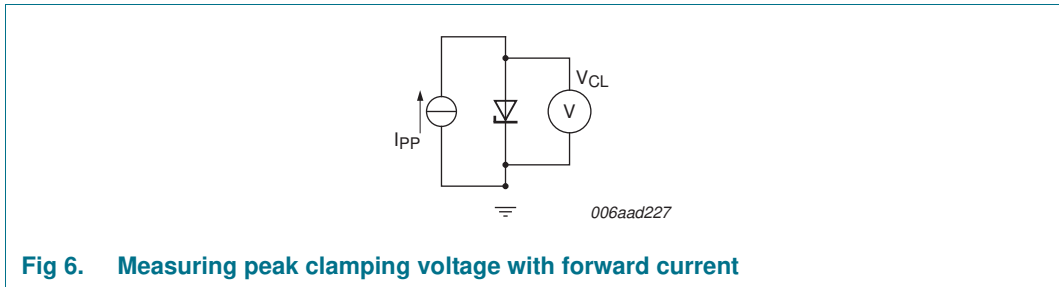


Fig 6. Measuring peak clamping voltage with forward current

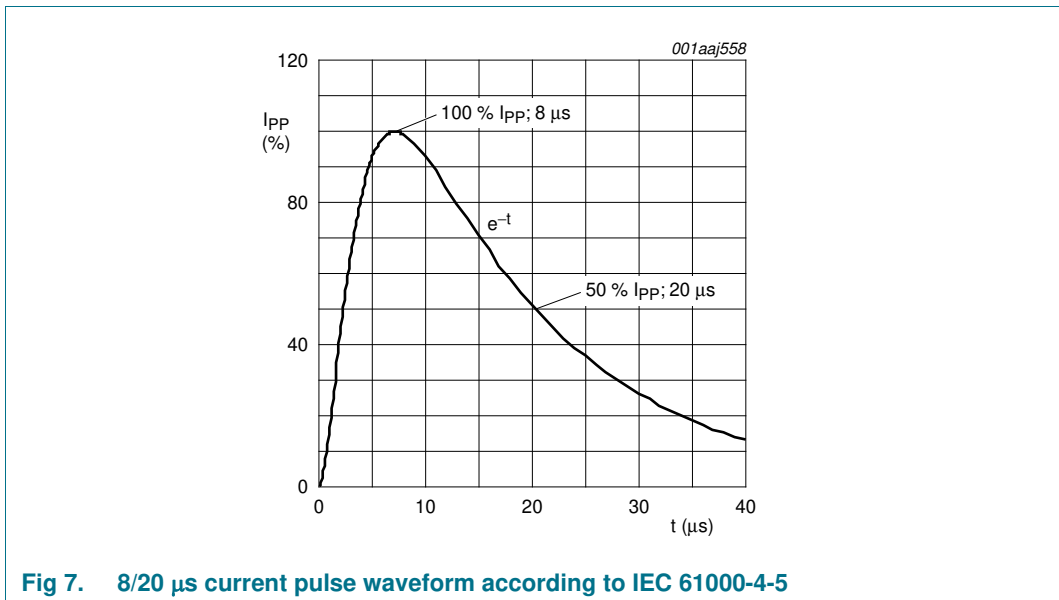
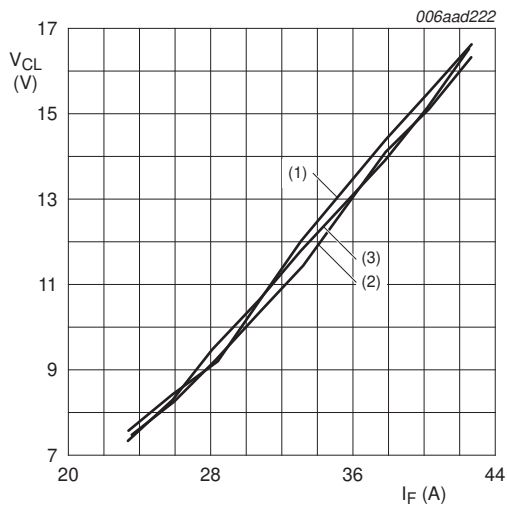
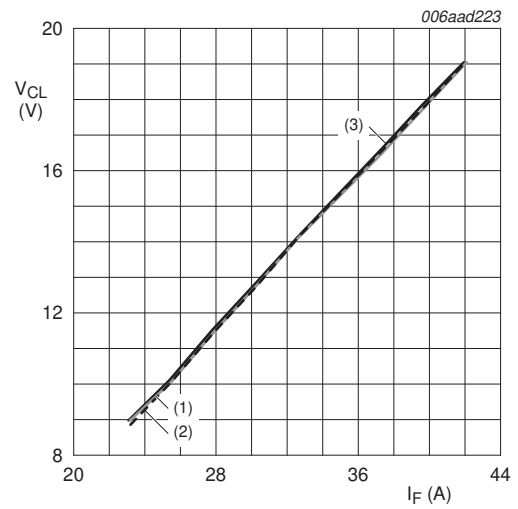


Fig 7. 8/20  $\mu\text{s}$  current pulse waveform according to IEC 61000-4-5



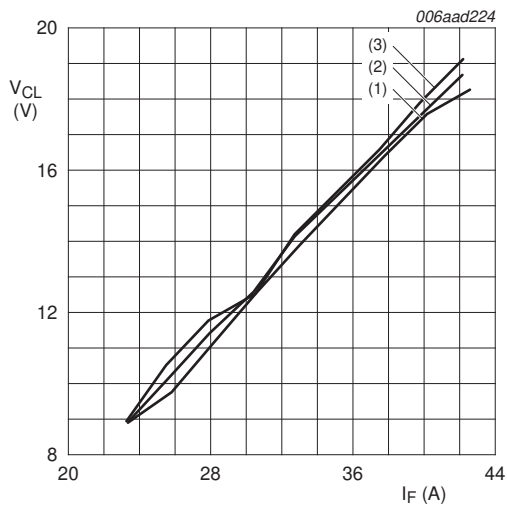
- (1)  $T_{amb} = +25\text{ }^{\circ}\text{C}$
- (2)  $T_{amb} = +85\text{ }^{\circ}\text{C}$
- (3)  $T_{amb} = -30\text{ }^{\circ}\text{C}$

Fig 8. IP4085CX4: peak clamping voltage as a function of forward current



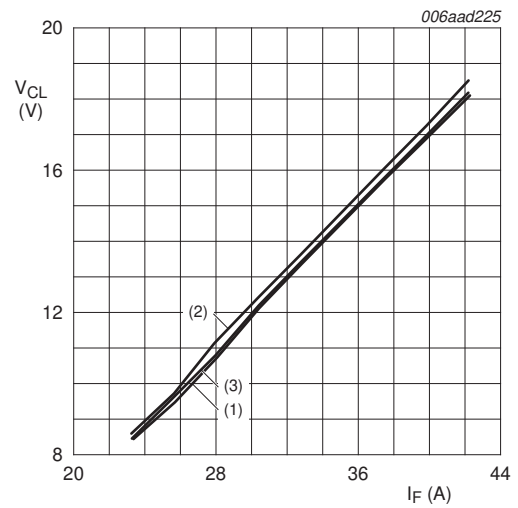
- (1)  $T_{amb} = +25\text{ }^{\circ}\text{C}$
- (2)  $T_{amb} = +85\text{ }^{\circ}\text{C}$
- (3)  $T_{amb} = -30\text{ }^{\circ}\text{C}$

Fig 9. IP4385CX4: peak clamping voltage as a function of forward current



- (1)  $T_{amb} = +25\text{ }^{\circ}\text{C}$
- (2)  $T_{amb} = +85\text{ }^{\circ}\text{C}$
- (3)  $T_{amb} = -30\text{ }^{\circ}\text{C}$

Fig 10. IP4386CX4: peak clamping voltage as a function of forward current



- (1)  $T_{amb} = +25\text{ }^{\circ}\text{C}$
- (2)  $T_{amb} = +85\text{ }^{\circ}\text{C}$
- (3)  $T_{amb} = -30\text{ }^{\circ}\text{C}$

Fig 11. IP4387CX4: peak clamping voltage as a function of forward current

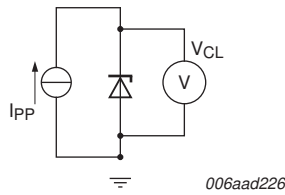
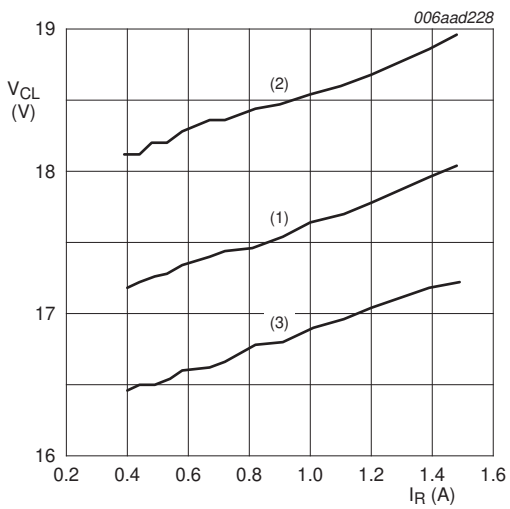
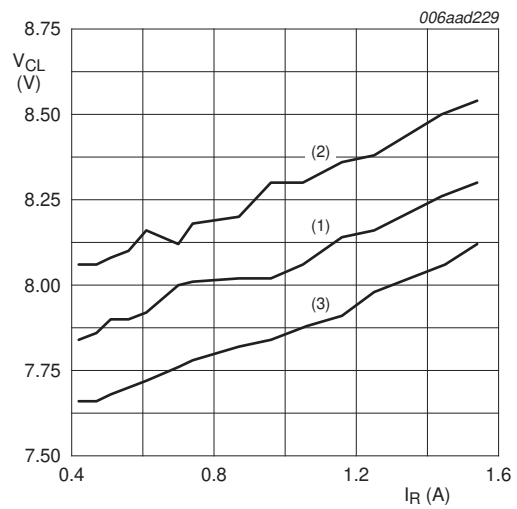


Fig 12. Measuring peak clamping voltage with reverse current



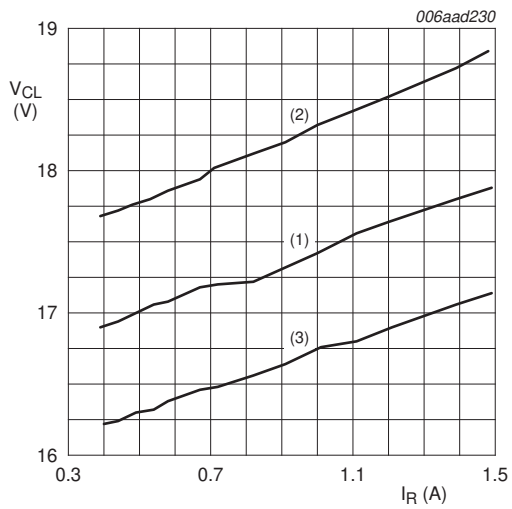
- (1)  $T_{amb} = +25\text{ }^{\circ}\text{C}$
- (2)  $T_{amb} = +85\text{ }^{\circ}\text{C}$
- (3)  $T_{amb} = -30\text{ }^{\circ}\text{C}$

Fig 13. IP4085CX4: peak clamping voltage as a function of reverse current



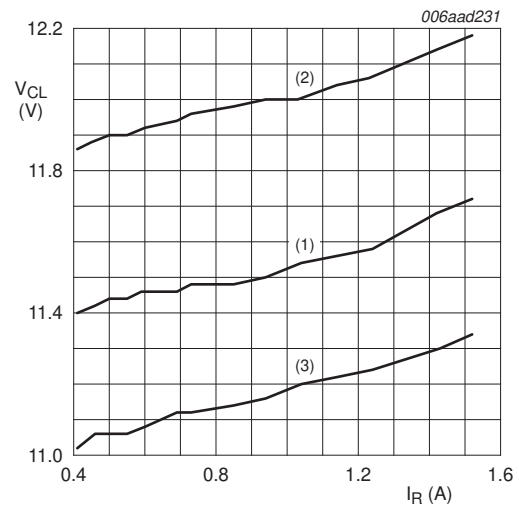
- (1)  $T_{amb} = +25\text{ }^{\circ}\text{C}$
- (2)  $T_{amb} = +85\text{ }^{\circ}\text{C}$
- (3)  $T_{amb} = -30\text{ }^{\circ}\text{C}$

Fig 14. IP4385CX4: peak clamping voltage as a function of reverse current



- (1)  $T_{amb} = +25\text{ }^{\circ}\text{C}$ .
- (2)  $T_{amb} = +85\text{ }^{\circ}\text{C}$ .
- (3)  $T_{amb} = -30\text{ }^{\circ}\text{C}$ .

Fig 15. IP4386CX4: peak clamping voltage as a function of reverse current

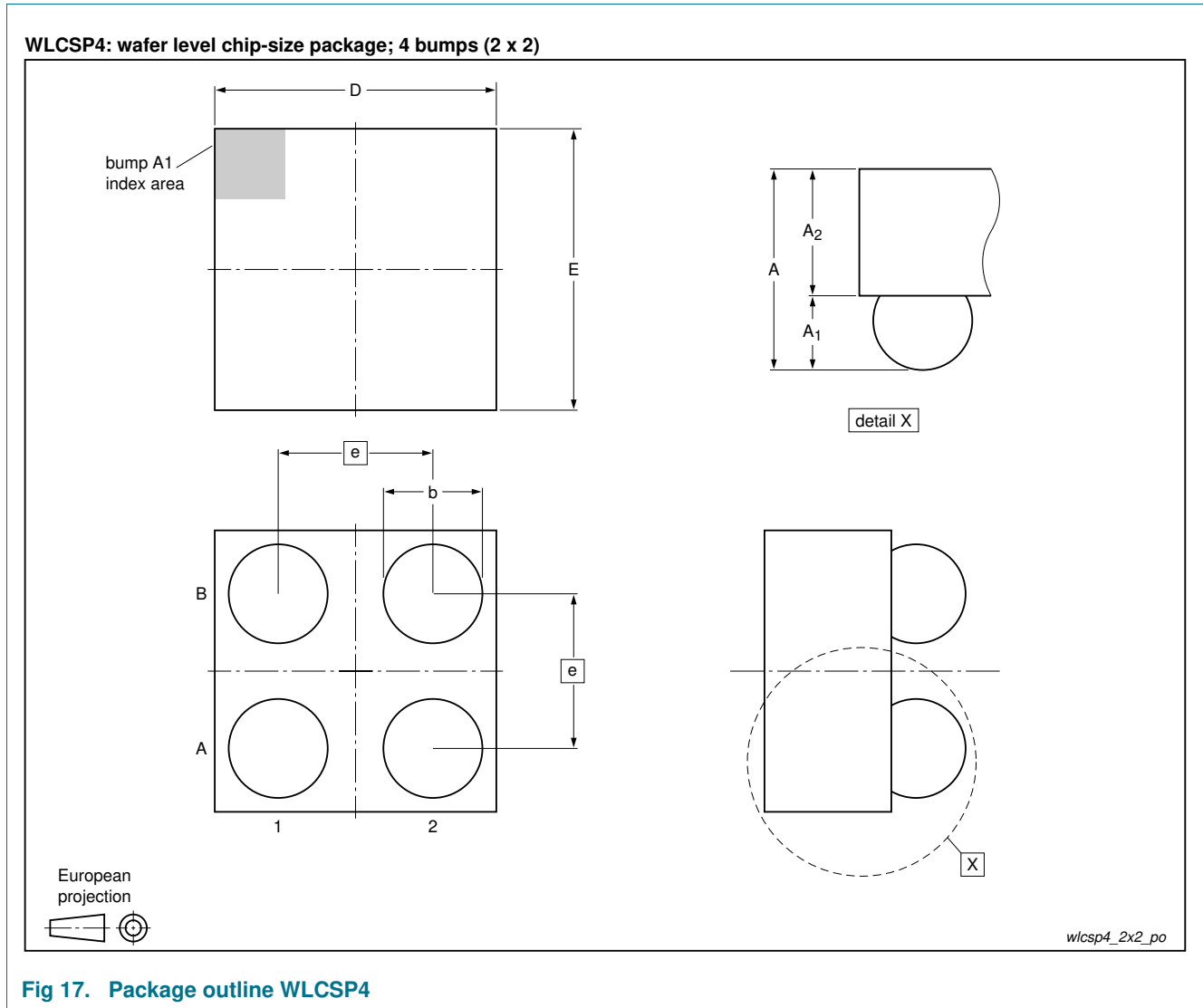


- (1)  $T_{amb} = +25\text{ }^{\circ}\text{C}$ .
- (2)  $T_{amb} = +85\text{ }^{\circ}\text{C}$ .
- (3)  $T_{amb} = -30\text{ }^{\circ}\text{C}$ .

Fig 16. IP4387CX4: peak clamping voltage as a function of reverse current

Measurements are done on a heat-dissipation optimized PCB with massive copper area under the Device Under Test (DUT).

## 8. Package outline



**Table 6. Package outline dimensions of IP4085CX4 (WLCSP4)**

Symbol	Min	Typ	Max	Unit
A	0.60	0.65	0.70	mm
A <sub>1</sub>	0.22	0.24	0.26	mm
A <sub>2</sub>	0.38	0.41	0.44	mm
b	0.27	0.32	0.37	mm
D	0.86	0.91	0.96	mm
E	0.86	0.91	0.96	mm
e	0.5	0.5	0.5	mm

Table 7. Package outline dimensions of IP438xCX4 (WLCSP4)

Symbol	Min	Typ	Max	Unit
A	0.56	0.61	0.66	mm
A <sub>1</sub>	0.18	0.20	0.22	mm
A <sub>2</sub>	0.38	0.41	0.44	mm
b	0.21	0.26	0.31	mm
D	0.71	0.76	0.76	mm
E	0.71	0.76	0.81	mm
e	0.4	0.4	0.4	mm

## 9. Design and assembly recommendations

### 9.1 PCB design guidelines

For optimum performance, use a Non-Solder Mask Defined (NSMD), also known as a copper-defined design, incorporating laser-drilled micro-vias connecting the ground pads to a buried ground-plane layer. This results in the lowest possible ground inductance and provides the best high frequency and ESD performance. Refer to [Table 8](#) for the recommended PCB design parameters.

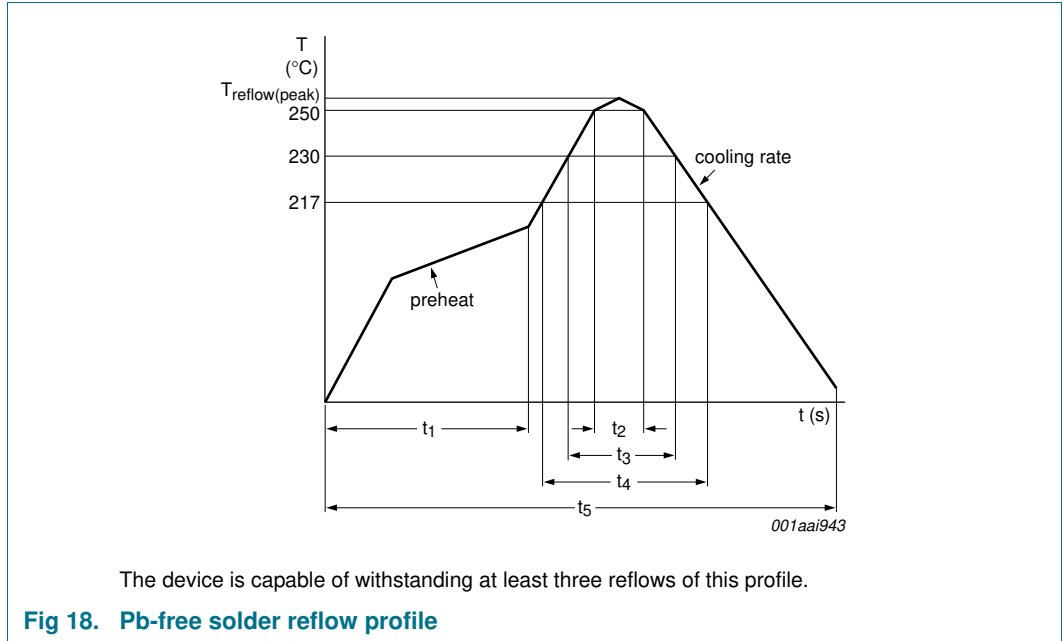
Table 8. Recommended PCB design parameters

Parameter	Value or Specification
PCB pad diameter	200 μm
Micro-via diameter	100 μm (0.004 inch)
Solder mask aperture diameter	370 μm
Copper thickness	20 μm to 40 μm
Copper finish	AuNi
PCB material	FR4

### 9.2 PCB assembly guidelines for Pb-free soldering

Table 9. Assembly recommendations

Parameter	Value or Specification
Solder screen aperture diameter	330 μm
Solder screen thickness	100 μm (0.004 inch)
Solder paste: Pb-free	SnAg (3 % to 4 %) Cu (0.5 % to 0.9 %)
Solder to flux ratio	50 : 50
Solder reflow profile	see <a href="#">Figure 18</a>



**Table 10. Reflow soldering process characteristics**

Symbol	Parameter	Conditions	Min	Typ	Max	Unit
$T_{\text{reflow(peak)}}$	peak reflow temperature		230	-	260	°C
$t_1$	time 1	soak time	60	-	180	s
$t_2$	time 2	time during $T \geq 250 \text{ }^\circ\text{C}$	-	-	30	s
$t_3$	time 3	time during $T \geq 230 \text{ }^\circ\text{C}$	10	-	50	s
$t_4$	time 4	time during $T > 217 \text{ }^\circ\text{C}$	30	-	150	s
$t_5$	time 5		-	-	540	s
$dT/dt$	rate of change of temperature	cooling rate	-	-	-6	°C/s
		pre-heat	2.5	-	4.0	°C/s

## 10. Soldering

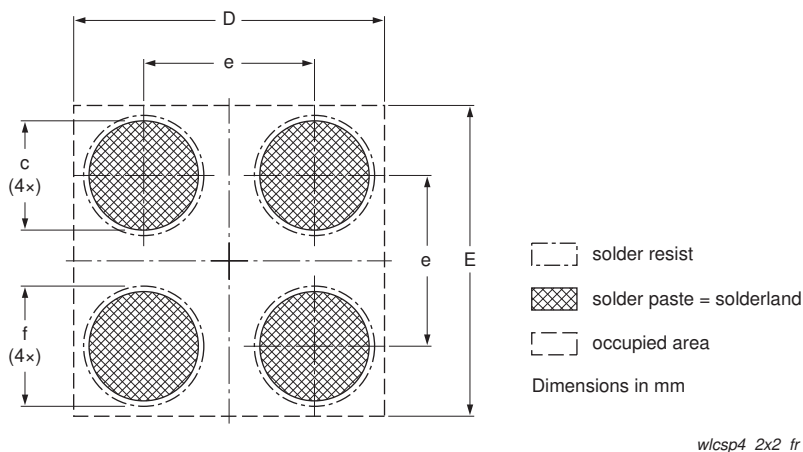


Fig 19. Reflow soldering footprint WLCSP4

Table 11. Soldering dimensions of IP4085CX4 (WLCSP4)

Symbol	Min	Typ	Max	Unit
c	-	0.31	-	mm
D	0.86	0.91	0.96	mm
E	0.86	0.91	0.96	mm
e	-	0.5	-	mm
f	-	0.385	-	mm

Table 12. Soldering dimensions of IP438xCX4 (WLCSP4)

Symbol	Min	Typ	Max	Unit
c	-	0.25	-	mm
D	0.71	0.76	0.81	mm
E	0.71	0.76	0.81	mm
e	-	0.4	-	mm
f	-	0.325	-	mm



## 11. Revision history

Table 13. Revision history

Document ID	Release date	Data sheet status	Change notice	Supersedes
IP4085_4385_4386_4387_CX4 v.2	20121214	Product data sheet	-	IP4085_4385_4386_4387_CX4 v.1
Modifications:				
			<ul style="list-style-type: none"> <li>• Basic type IP4085CX4/LF removed</li> <li>• <a href="#">Section 1 “Product profile”</a>: updated</li> <li>• <a href="#">Section 2 “Pinning information”</a>: updated</li> <li>• Functional diagram: removed</li> <li>• <a href="#">Table 3 “Limiting values”</a>: updated</li> <li>• <a href="#">Table 5 “Electrical characteristics”</a>: updated</li> <li>• <a href="#">Section 7 “Application information”</a>: updated</li> <li>• <a href="#">Figure 1, 6, 8 to 16</a>: updated</li> <li>• Marking: removed</li> <li>• <a href="#">Section 8 “Package outline”</a>: updated</li> <li>• <a href="#">Section 10 “Soldering”</a>: added</li> <li>• <a href="#">Section 12 “Legal information”</a>: updated</li> </ul>	
IP4085_4385_4386_4387_CX4 v.1	20090326	Product data sheet	-	-

## 12. Legal information

### 12.1 Data sheet status

Document status <sup>[1][2]</sup>	Product status <sup>[3]</sup>	Definition
Objective [short] data sheet	Development	This document contains data from the objective specification for product development.
Preliminary [short] data sheet	Qualification	This document contains data from the preliminary specification.
Product [short] data sheet	Production	This document contains the product specification.

[1] Please consult the most recently issued document before initiating or completing a design.

[2] The term 'short data sheet' is explained in section "Definitions".

[3] The product status of device(s) described in this document may have changed since this document was published and may differ in case of multiple devices. The latest product status information is available on the Internet at URL <http://www.nxp.com>.

### 12.2 Definitions

**Draft** — The document is a draft version only. The content is still under internal review and subject to formal approval, which may result in modifications or additions. NXP Semiconductors does not give any representations or warranties as to the accuracy or completeness of information included herein and shall have no liability for the consequences of use of such information.

**Short data sheet** — A short data sheet is an extract from a full data sheet with the same product type number(s) and title. A short data sheet is intended for quick reference only and should not be relied upon to contain detailed and full information. For detailed and full information see the relevant full data sheet, which is available on request via the local NXP Semiconductors sales office. In case of any inconsistency or conflict with the short data sheet, the full data sheet shall prevail.

**Product specification** — The information and data provided in a Product data sheet shall define the specification of the product as agreed between NXP Semiconductors and its customer, unless NXP Semiconductors and customer have explicitly agreed otherwise in writing. In no event however, shall an agreement be valid in which the NXP Semiconductors product is deemed to offer functions and qualities beyond those described in the Product data sheet.

### 12.3 Disclaimers

**Limited warranty and liability** — Information in this document is believed to be accurate and reliable. However, NXP Semiconductors does not give any representations or warranties, expressed or implied, as to the accuracy or completeness of such information and shall have no liability for the consequences of use of such information. NXP Semiconductors takes no responsibility for the content in this document if provided by an information source outside of NXP Semiconductors.

In no event shall NXP Semiconductors be liable for any indirect, incidental, punitive, special or consequential damages (including - without limitation - lost profits, lost savings, business interruption, costs related to the removal or replacement of any products or rework charges) whether or not such damages are based on tort (including negligence), warranty, breach of contract or any other legal theory.

Notwithstanding any damages that customer might incur for any reason whatsoever, NXP Semiconductors' aggregate and cumulative liability towards customer for the products described herein shall be limited in accordance with the *Terms and conditions of commercial sale* of NXP Semiconductors.

**Right to make changes** — NXP Semiconductors reserves the right to make changes to information published in this document, including without limitation specifications and product descriptions, at any time and without notice. This document supersedes and replaces all information supplied prior to the publication hereof.

**Suitability for use** — NXP Semiconductors products are not designed, authorized or warranted to be suitable for use in life support, life-critical or safety-critical systems or equipment, nor in applications where failure or malfunction of an NXP Semiconductors product can reasonably be expected to result in personal injury, death or severe property or environmental damage. NXP Semiconductors and its suppliers accept no liability for inclusion and/or use of NXP Semiconductors products in such equipment or applications and therefore such inclusion and/or use is at the customer's own risk.

**Applications** — Applications that are described herein for any of these products are for illustrative purposes only. NXP Semiconductors makes no representation or warranty that such applications will be suitable for the specified use without further testing or modification.

Customers are responsible for the design and operation of their applications and products using NXP Semiconductors products, and NXP Semiconductors accepts no liability for any assistance with applications or customer product design. It is customer's sole responsibility to determine whether the NXP Semiconductors product is suitable and fit for the customer's applications and products planned, as well as for the planned application and use of customer's third party customer(s). Customers should provide appropriate design and operating safeguards to minimize the risks associated with their applications and products.

NXP Semiconductors does not accept any liability related to any default, damage, costs or problem which is based on any weakness or default in the customer's applications or products, or the application or use by customer's third party customer(s). Customer is responsible for doing all necessary testing for the customer's applications and products using NXP Semiconductors products in order to avoid a default of the applications and the products or of the application or use by customer's third party customer(s). NXP does not accept any liability in this respect.

**Limiting values** — Stress above one or more limiting values (as defined in the Absolute Maximum Ratings System of IEC 60134) will cause permanent damage to the device. Limiting values are stress ratings only and (proper) operation of the device at these or any other conditions above those given in the Recommended operating conditions section (if present) or the Characteristics sections of this document is not warranted. Constant or repeated exposure to limiting values will permanently and irreversibly affect the quality and reliability of the device.

**Terms and conditions of commercial sale** — NXP Semiconductors products are sold subject to the general terms and conditions of commercial sale, as published at <http://www.nxp.com/profile/terms>, unless otherwise agreed in a valid written individual agreement. In case an individual agreement is concluded only the terms and conditions of the respective agreement shall apply. NXP Semiconductors hereby expressly objects to applying the customer's general terms and conditions with regard to the purchase of NXP Semiconductors products by customer.

**No offer to sell or license** — Nothing in this document may be interpreted or construed as an offer to sell products that is open for acceptance or the grant, conveyance or implication of any license under any copyrights, patents or other industrial or intellectual property rights.

**Export control** — This document as well as the item(s) described herein may be subject to export control regulations. Export might require a prior authorization from competent authorities.

**Quick reference data** — The Quick reference data is an extract of the product data given in the Limiting values and Characteristics sections of this document, and as such is not complete, exhaustive or legally binding.

**Non-automotive qualified products** — Unless this data sheet expressly states that this specific NXP Semiconductors product is automotive qualified, the product is not suitable for automotive use. It is neither qualified nor tested in accordance with automotive testing or application requirements. NXP Semiconductors accepts no liability for inclusion and/or use of non-automotive qualified products in automotive equipment or applications.

In the event that customer uses the product for design-in and use in automotive applications to automotive specifications and standards, customer (a) shall use the product without NXP Semiconductors' warranty of the product for such automotive applications, use and specifications, and (b) whenever customer uses the product for automotive applications beyond NXP Semiconductors' specifications such use shall be solely at customer's own risk, and (c) customer fully indemnifies NXP Semiconductors for any liability, damages or failed product claims resulting from customer design and use of the product for automotive applications beyond NXP Semiconductors' standard warranty and NXP Semiconductors' product specifications.

## 12.4 Trademarks

Notice: All referenced brands, product names, service names and trademarks are the property of their respective owners.

## 13. Contact information

---

For more information, please visit: <http://www.nxp.com>

For sales office addresses, please send an email to: [salesaddresses@nxp.com](mailto:salesaddresses@nxp.com)

## 14. Contents

<b>1</b>	<b>Product profile</b> . . . . .	<b>1</b>
1.1	General description . . . . .	1
1.2	Features and benefits . . . . .	1
1.3	Applications . . . . .	1
<b>2</b>	<b>Pinning information</b> . . . . .	<b>2</b>
<b>3</b>	<b>Ordering information</b> . . . . .	<b>2</b>
<b>4</b>	<b>Limiting values</b> . . . . .	<b>3</b>
<b>5</b>	<b>Thermal characteristics</b> . . . . .	<b>4</b>
<b>6</b>	<b>Characteristics</b> . . . . .	<b>4</b>
<b>7</b>	<b>Application information</b> . . . . .	<b>5</b>
7.1	Forward current DC clamping voltage . . . . .	5
7.2	Peak clamping voltage . . . . .	7
<b>8</b>	<b>Package outline</b> . . . . .	<b>11</b>
<b>9</b>	<b>Design and assembly recommendations</b> . . . . .	<b>12</b>
9.1	PCB design guidelines . . . . .	12
9.2	PCB assembly guidelines for Pb-free soldering . . . . .	12
<b>10</b>	<b>Soldering</b> . . . . .	<b>14</b>
<b>11</b>	<b>Revision history</b> . . . . .	<b>15</b>
<b>12</b>	<b>Legal information</b> . . . . .	<b>16</b>
12.1	Data sheet status . . . . .	16
12.2	Definitions . . . . .	16
12.3	Disclaimers . . . . .	16
12.4	Trademarks . . . . .	17
<b>13</b>	<b>Contact information</b> . . . . .	<b>17</b>
<b>14</b>	<b>Contents</b> . . . . .	<b>18</b>

Please be aware that important notices concerning this document and the product(s) described herein, have been included in section 'Legal information'.

© NXP B.V. 2012.

All rights reserved.

For more information, please visit: <http://www.nxp.com>

For sales office addresses, please send an email to: [salesaddresses@nxp.com](mailto:salesaddresses@nxp.com)

Date of release: 14 December 2012

Document identifier: IP4085\_4385\_4386\_4387\_CX4