



Chipsmall Limited consists of a professional team with an average of over 10 year of expertise in the distribution of electronic components. Based in Hongkong, we have already established firm and mutual-benefit business relationships with customers from,Europe,America and south Asia,supplying obsolete and hard-to-find components to meet their specific needs.

With the principle of “Quality Parts,Customers Priority,Honest Operation,and Considerate Service”,our business mainly focus on the distribution of electronic components. Line cards we deal with include Microchip,ALPS,ROHM,Xilinx,Pulse,ON,Everlight and Freescale. Main products comprise IC,Modules,Potentiometer,IC Socket,Relay,Connector.Our parts cover such applications as commercial,industrial, and automotives areas.

We are looking forward to setting up business relationship with you and hope to provide you with the best service and solution. Let us make a better world for our industry!



Contact us

Tel: +86-755-8981 8866 Fax: +86-755-8427 6832

Email & Skype: info@chipsmall.com Web: www.chipsmall.com

Address: A1208, Overseas Decoration Building, #122 Zhenhua RD., Futian, Shenzhen, China



Important notice

Dear Customer,

On 7 February 2017 the former NXP Standard Product business became a new company with the tradename **Nexperia**. Nexperia is an industry leading supplier of Discrete, Logic and PowerMOS semiconductors with its focus on the automotive, industrial, computing, consumer and wearable application markets

In data sheets and application notes which still contain NXP or Philips Semiconductors references, use the references to Nexperia, as shown below.

Instead of <http://www.nxp.com>, <http://www.philips.com/> or <http://www.semiconductors.philips.com/>, use <http://www.nexperia.com>

Instead of sales.addresses@www.nxp.com or sales.addresses@www.semiconductors.philips.com, use salesaddresses@nexperia.com (email)

Replace the copyright notice at the bottom of each page or elsewhere in the document, depending on the version, as shown below:

- © NXP N.V. (year). All rights reserved or © Koninklijke Philips Electronics N.V. (year). All rights reserved

Should be replaced with:

- © **Nexperia B.V. (year). All rights reserved.**

If you have any questions related to the data sheet, please contact our nearest sales office via e-mail or telephone (details via salesaddresses@nexperia.com). Thank you for your cooperation and understanding,

Kind regards,

Team Nexperia

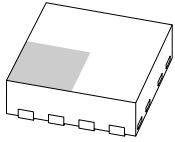

IP4264CZ8-10/20/40-TTL

Integrated (U)SIM card passive filter array with ESD protection

Rev. 2 — 12 October 2011

Product data sheet

1. Product profile

1.1 General description

The IP4264CZ8-10-TTL, IP4264CZ8-20-TTL and IP4264CZ8-40-TTL are 3-channel RC low-pass filter arrays. They are designed to provide filtering of undesired RF signals in the 800 MHz-to-3000 MHz frequency band. They incorporate diodes to provide protection to downstream components from ElectroStatic Discharge (ESD) voltages up to ± 25 kV contact and higher than ± 25 kV air discharge, far exceeding IEC 61000-4-2, level 4.

The devices support ESD protection of the USB data pins of a Universal Subscriber Identity Module (USIM) interface, as well as the digital standard SIM interface ESD protection and ElectroMagnetic Interface (EMI) filtering.

The devices are fabricated using monolithic silicon technology. They integrate three resistors and eight high-level ESD protection diodes in a 0.4 mm pitch Quad Flat-pack No-leads (QFN) plastic package with a height of only 0.5 mm. These features make all three devices ideal for use in applications requiring component miniaturization, such as mobile phone handsets, cordless telephones and personal digital devices.

Similar products are available in Wafer Level Chip-Size Package (WLCSP). IP4365CX11/P (0.4 mm pitch, 11-ball WLCSP11) is designed for USIM interfaces. IP4364CX8 (0.4 mm pitch, 8-ball WLCSP8) and IP4064CX8 (0.5 mm pitch, 8-ball WLCSP8) are designed for SIM interfaces.

1.2 Features and benefits

- Pb-free, Restriction of Hazardous Substances (RoHS) compliant and free of halogen and antimony (Dark Green compliant)
- 3-channel SIM card interface integrated RC-filter array and SIM voltage ESD protection
- 2 USIM (USB 1.1) compliant ESD protection diodes with 20 pF channel capacitance
- Integrated 100 Ω /100 Ω /47 Ω series channel resistors
- Total channel capacitance of 10 pF (IP4264CZ8-10-TTL), 20 pF (IP4264CZ8-20-TTL) or 40 pF (IP4264CZ8-40-TTL)
- Downstream ESD protection up to ± 25 kV (contact) according to IEC 61000-4-2
- Micropak (QFN compatible) plastic package with 0.4 mm pitch

1.3 Applications

- SIM interfaces in for example, cellular phone and Personal Communication System (PCS) mobile handsets



2. Pinning information

Table 1. Pinning

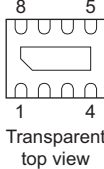
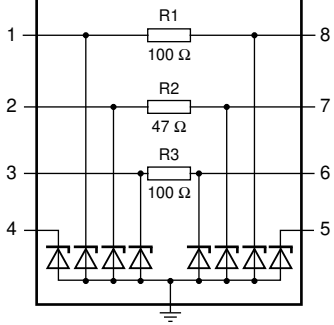
Pin	Description	Simplified outline	Graphic symbol
1 and 8	filter channel 1		
2 and 7	filter channel 2		
3 and 6	filter channel 3		
4 and 5	ESD protection		
GND	ground		

018aaa015

3. Ordering information

Table 2. Ordering information

Type number	Package		Version
	Name	Description	
IP4264CZ8-10-TTL	HUSON8	plastic thermal enhanced extremely thin small outline package; no leads; 8 terminals; body 1.35 × 1.7 × 0.55 mm	SOT1166-1
IP4264CZ8-20-TTL			
IP4264CZ8-40-TTL			

4. Marking

Table 3. Marking codes

Type number	Marking code
IP4264CZ8-10-TTL	N1
IP4264CZ8-20-TTL	N2
IP4264CZ8-40-TTL	N4

5. Limiting values

Table 4. Limiting values

In accordance with the Absolute Maximum Rating System (IEC 60134).

Symbol	Parameter	Conditions	Min	Max	Unit	
IP4264CZ8-10-TTL						
V _{ESD}	electrostatic discharge voltage	pins 1, 2 and 3 to ground [1]				
			contact discharge	-10	+10	kV
			air discharge	-15	+15	kV
		pins 6, 7 and 8 to ground [1]				
			contact discharge	-8	+8	kV
			air discharge	-15	+15	kV
		pins 5 and 6 to ground [1]				
			contact discharge	-15	+15	kV
			air discharge	-15	+15	kV
IP4264CZ8-20-TTL						
V _{ESD}	electrostatic discharge voltage	all pins to ground [1]				
			contact discharge	-15	+15	kV
			air discharge	-15	+15	kV
IP4264CZ8-40-TTL						
V _{ESD}	electrostatic discharge voltage	all pins to ground [1]				
			contact discharge	-25	+25	kV
			air discharge	-25	+25	kV
IP4264CZ8-10-TTL, IP4264CZ8-20-TTL and IP4264CZ8-40-TTL						
V _{ESD}	electrostatic discharge voltage	IEC 61000-4-2, level 4; all pins to ground				
			contact discharge	-8	+8	kV
			air discharge	-15	+15	kV
V _I	input voltage	at I/O pins	-0.5	+5.5	V	
P _{ch}	channel power dissipation	T _{amb} = 70 °C	-	60	mW	
P _{tot}	total power dissipation	T _{amb} = 70 °C	-	180	mW	
T _{stg}	storage temperature		-55	+150	°C	
T _{reflow(peak)}	peak reflow temperature	t _p ≤ 10 s	-	260	°C	
T _{amb}	ambient temperature		-30	+85	°C	

[1] All devices are qualified using 1000 contact discharges of ±8 kV (IP4264CZ8-10-TTL and IP4264CZ8-20-TTL) or ±25 kV (IP4264CZ8-40-TTL) using the IEC 61000-4-2 model, far exceeding the specified IEC 61000-4-2, level 4 (8 kV contact discharge).

6. Characteristics

Table 5. Channel resistance

$T_{amb} = 25\text{ }^{\circ}\text{C}$ unless otherwise specified.

Symbol	Parameter	Conditions	Min	Typ	Max	Unit
$R_{s(ch)}$	channel series resistance	R1, R3	85	100	115	Ω
		R2	40	47	54	Ω

Table 6. Channel characteristics

$T_{amb} = 25\text{ }^{\circ}\text{C}$ unless otherwise specified.

Symbol	Parameter	Conditions	Min	Typ	Max	Unit
I_{RM}	reverse leakage current	$V_I = 3\text{ V}$	-	-	50	nA
V_{BR}	breakdown voltage	$I_{test} = 1\text{ mA}$	6	-	10	V

IP4264CZ8-10-TTL

C_{ch}	channel capacitance	$f = 1\text{ MHz}$	[1][2]			
		$V_{bias(DC)} = 0\text{ V}$	8	10	12	pF
		$V_{bias(DC)} = 2.5\text{ V}$	4	6	8	pF
C_d	diode capacitance	$f = 1\text{ MHz}$	[1][3]			
		$V_{bias(DC)} = 0\text{ V}$	8	10	12	pF
		$V_{bias(DC)} = 2.5\text{ V}$	4	6	8	pF

IP4264CZ8-20-TTL

C_{ch}	channel capacitance	$f = 1\text{ MHz}$	[1][2]			
		$V_{bias(DC)} = 0\text{ V}$	-	17	20	pF
		$V_{bias(DC)} = 2.5\text{ V}$	-	11	15	pF

IP4264CZ8-40-TTL

C_{ch}	channel capacitance	$f = 1\text{ MHz}$	[1][2]			
		$V_{bias(DC)} = 0\text{ V}$	-	35	40	pF
		$V_{bias(DC)} = 2.5\text{ V}$	-	23	28	pF

IP4264CZ8-20-TTL and IP4264CZ8-40-TTL

C_d	diode capacitance	$f = 1\text{ MHz}$	[3]			
		$V_{bias(DC)} = 0\text{ V}$	12	16	20	pF
		$V_{bias(DC)} = 2.5\text{ V}$	8	11	14	pF

[1] Guaranteed by design.

[2] Total line capacitance including diode capacitance, per channel.

[3] Pins 4 and 5 to ground.

7. Application information

7.1 Insertion loss

The devices are designed as EMI/Radio Frequency Interference (RFI) filters for SIM card interfaces. The setup for measuring return loss is shown in [Figure 1](#).

The insertion loss in a 50 Ω system for all three channels of IP4264CZ8-10-TTL ($C_{ch} = 10 \text{ pF}$) is shown in [Figure 2](#). The same measurements for IP4264CZ8-20-TTL ($C_{ch} = 20 \text{ pF}$) are shown in [Figure 3](#). The insertion loss for IP4264CZ8-40-TTL ($C_{ch} = 10 \text{ pF}$) is shown in [Figure 4](#).

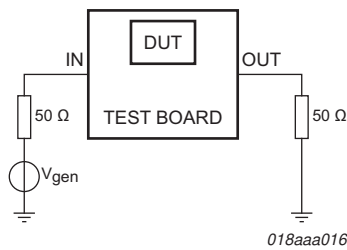
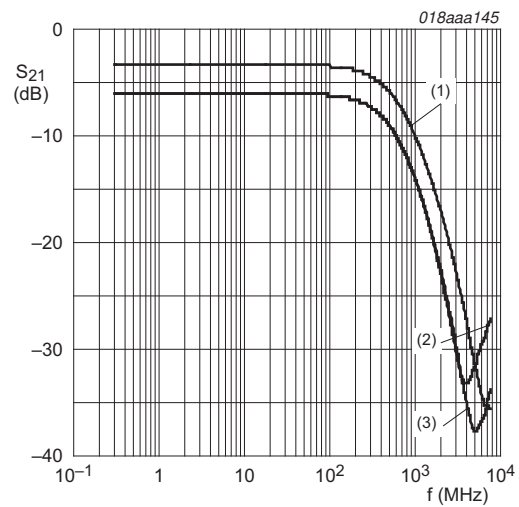

Fig 1. Frequency response setup



$C_{ch} = 10 \text{ pF}$

- (1) Pin 2 to 7
- (2) Pin 1 to 8
- (3) Pin 3 to 6

Fig 2. IP4264CZ8-10-TTL: Frequency response curves

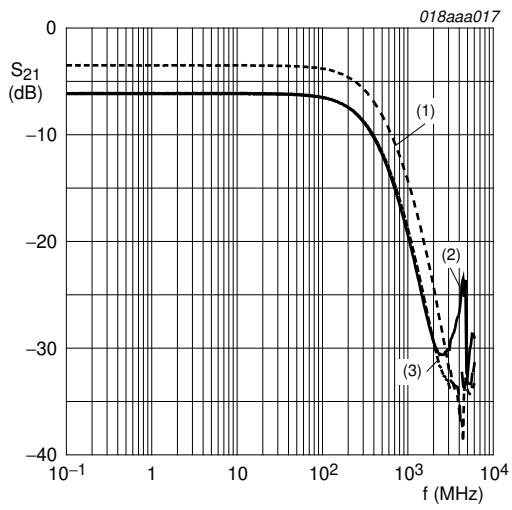

- $C_{ch} = 20 \text{ pF}$
- (1) Pin 2 to 7
 - (2) Pin 1 to 8
 - (3) Pin 3 to 6

Fig 3. IP4264CZ8-20-TTL: Frequency response curves

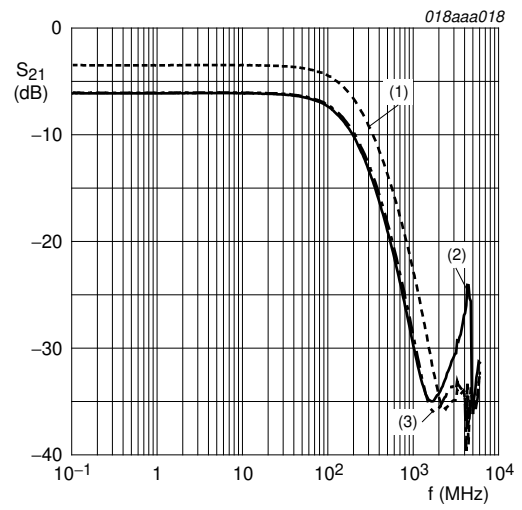

- $C_{ch} = 40 \text{ pF}$
- (1) Pin 2 to 7
 - (2) Pin 1 to 8
 - (3) Pin 3 to 6

Fig 4. IP4264CZ8-40-TTL: Frequency response curves

7.2 Crosstalk

The setup for measuring crosstalk between channels in a 50 Ω system is shown in [Figure 5](#). The crosstalk for IP4264CZ8-10-TTL is shown in [Figure 6](#), for IP4264CZ8-20-TTL in [Figure 7](#) and for IP4264CZ8-40-TTL in [Figure 8](#). Unused channels are terminated with a 50 Ω resistor to ground.

The crosstalk between any pin and pin 4 and pin 5 is similar to the crosstalk between the channels.

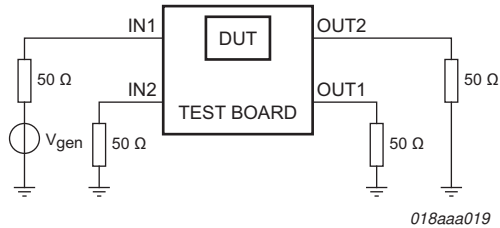
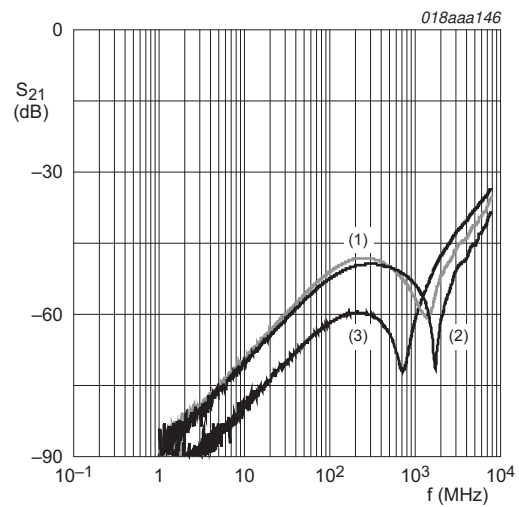
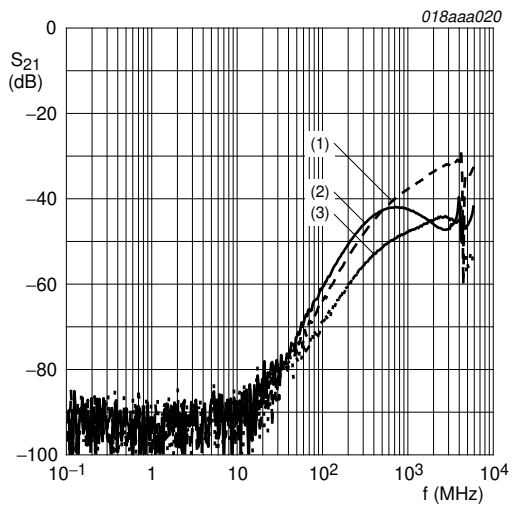

Fig 5. Crosstalk measurement setup



$C_{ch} = 10$ pF
 (1) Pin 1 to 7
 (2) Pin 2 to 6
 (3) Pin 3 to 8

Fig 6. IP4264CZ8-10-TTL: Crosstalk behavior



- $C_{ch} = 20 \text{ pF}$
- (1) Pin 1 to 7
 - (2) Pin 2 to 6
 - (3) Pin 3 to 8

Fig 7. IP4264CZ8-20-TTL: Crosstalk behavior

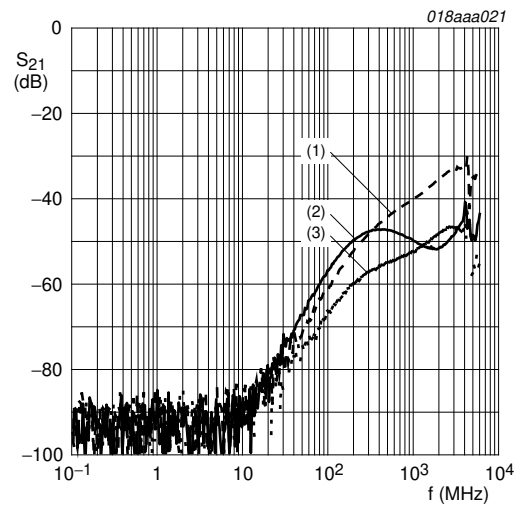

- $C_{ch} = 40 \text{ pF}$
- (1) Pin 1 to 7
 - (2) Pin 2 to 6
 - (3) Pin 3 to 8

Fig 8. IP4264CZ8-40-TTL: Crosstalk behavior

7.3 USIM and SIM interface application schematic

The application schematic diagram depicted in [Figure 9](#) demonstrates how the three NXP SIM card EMI filter and ESD protection devices are used in a typical USIM interface application.

For example, in case a standard SIM interface without USB 1.1 is used, the two single diodes (pins 4 and 5) can protect the VSIM line.

It is only one example dependent on layout constraints. For example, channels 1 to 8 can be swapped with channels 3 to 6.

Also, the USB interface ESD protection pins 4 and 5 can be exchanged. Due to both sides of the devices containing identical protection diodes, baseband and SIM card side can be swapped, too (pin 1 with pin 8, pin 2 with pin 7 etc.).

A standard SIM interface application is depicted in [Figure 10](#). In this case, both ESD protection diodes (pins 1 and 8) are used to protect VSIM.

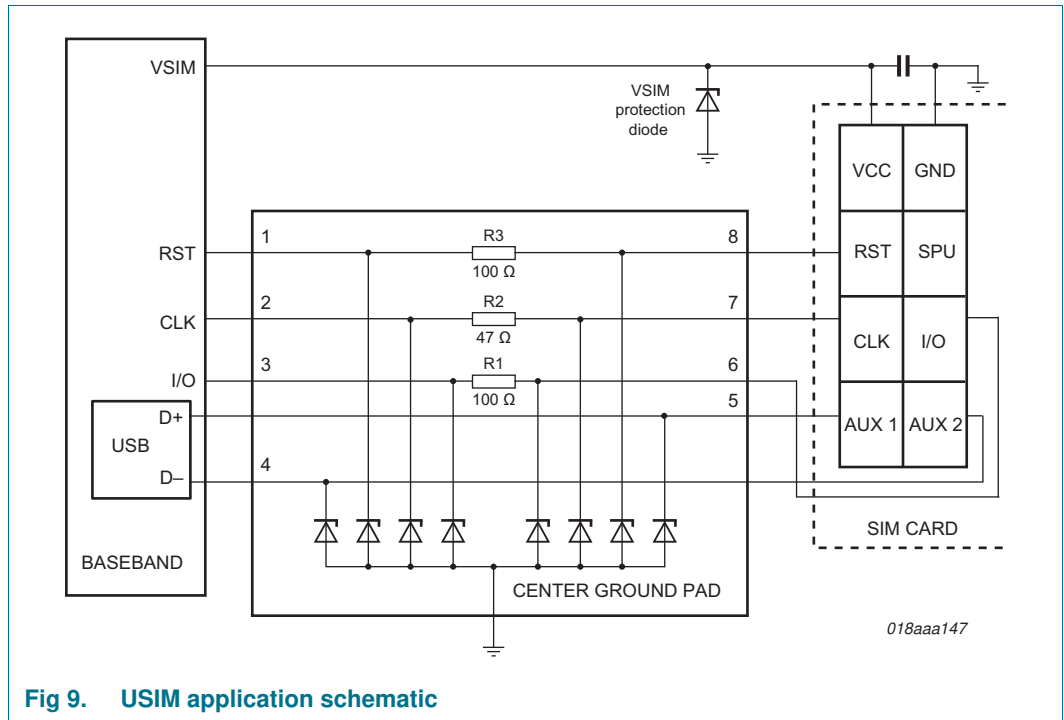

Fig 9. USIM application schematic

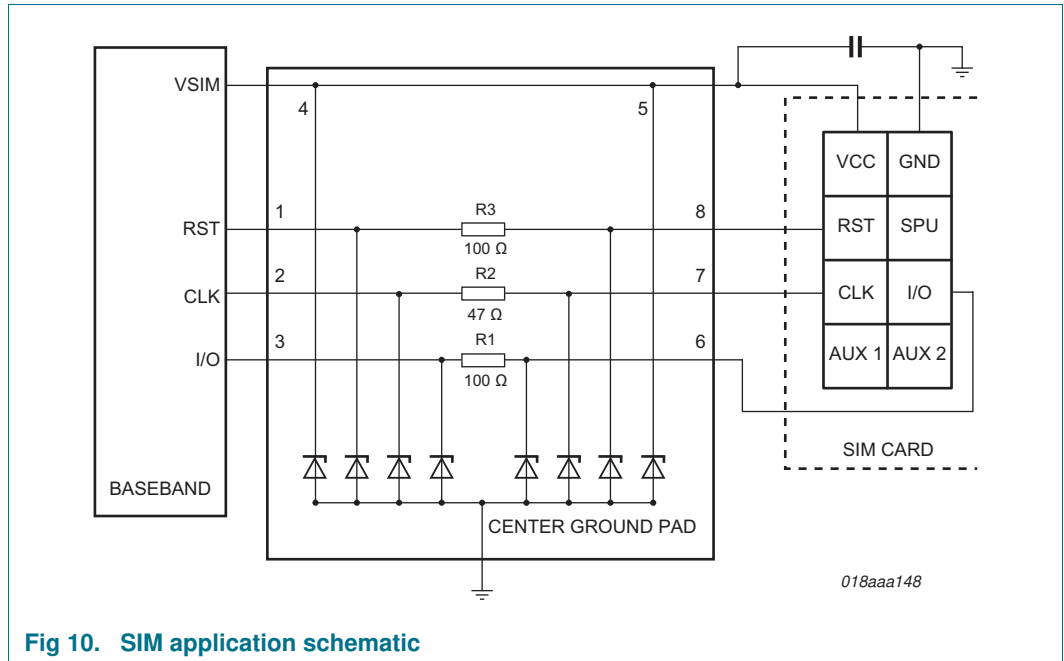

Fig 10. SIM application schematic

7.4 Compatible devices in WLCSP

The IP4264CZ8-10-TTL and IP4264CZ8-20-TTL are optimized for SIM and USIM interfaces. Comparable devices are also available in WLCSP:

- IP4064CX8, 0.5 mm pitch SIM interface device compatible with IP4264CZ8-20-TTL
- IP4364CX8, 0.4 mm pitch SIM interface device compatible with IP4264CZ8-20-TTL
- IP4366CX8/P, 0.4 mm pitch SIM interface device compatible with IP4264CZ8-10-TTL
- IP4365CX11/P, 0.4 mm pitch USIM interface device compatible with IP4264CZ8-10-TTL

8. Package outline

HUSON8: plastic, thermal enhanced ultra thin small outline package; no leads; 8 terminals; body 1.35 x 1.7 x 0.55 mm

SOT1166-1

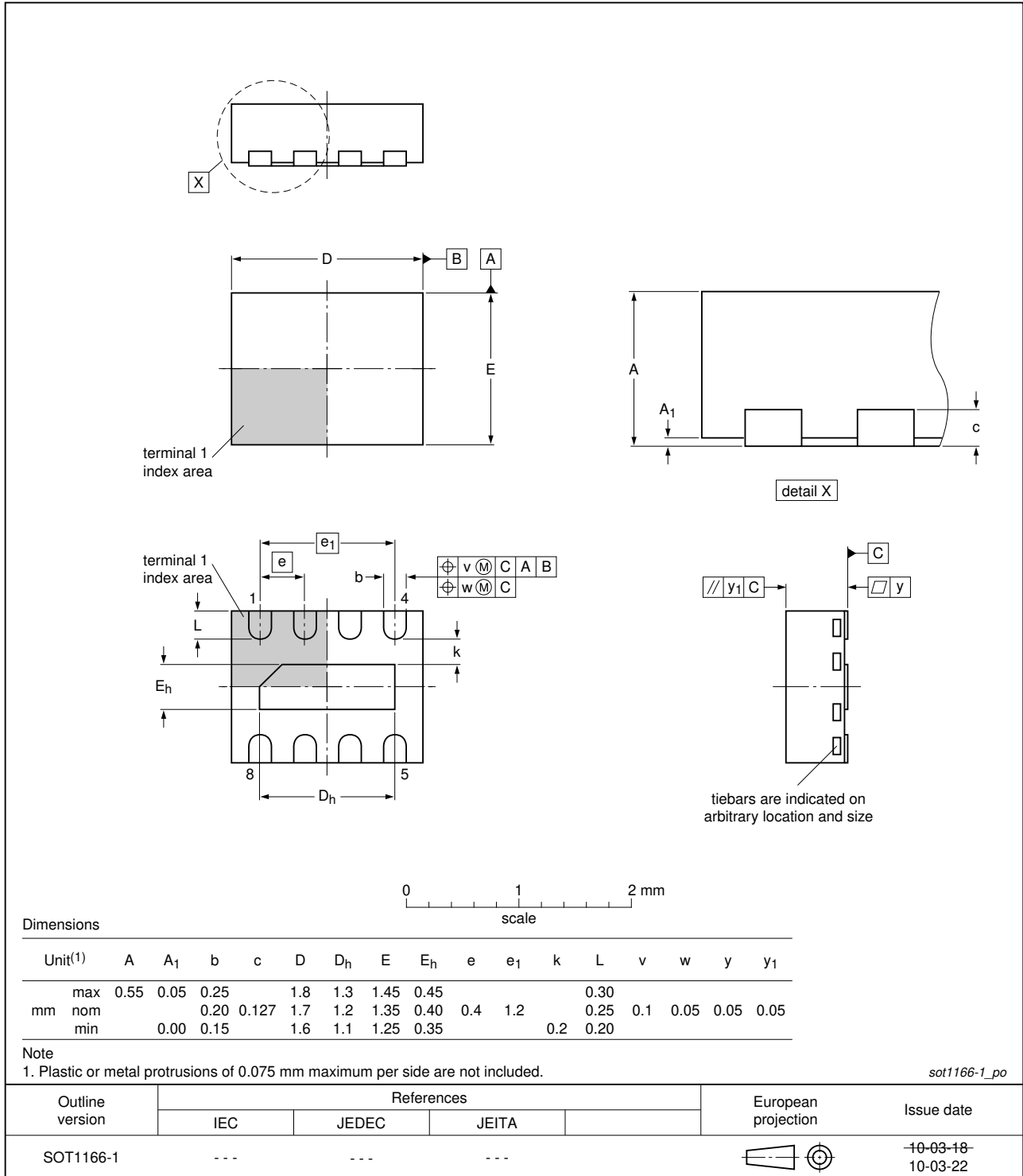

Fig 11. Package outline SOT1166-1 (HUSON8)

9. Revision history

Table 7. Revision history

Document ID	Release date	Data sheet status	Change notice	Supersedes
IP4264CZ8-10_20_40-TTL v.2	20111012	Product data sheet	-	IP4264CZ8-10_20_40-TTL v.1
Modifications:				
				<ul style="list-style-type: none">• Figure 2: corrected title• Section 10 "Legal information": updated
IP4264CZ8-10_20_40-TTL v.1	20110708	Product data sheet	-	-

10. Legal information

10.1 Data sheet status

Document status ^{[1][2]}	Product status ^[3]	Definition
Objective [short] data sheet	Development	This document contains data from the objective specification for product development.
Preliminary [short] data sheet	Qualification	This document contains data from the preliminary specification.
Product [short] data sheet	Production	This document contains the product specification.

[1] Please consult the most recently issued document before initiating or completing a design.

[2] The term 'short data sheet' is explained in section "Definitions".

[3] The product status of device(s) described in this document may have changed since this document was published and may differ in case of multiple devices. The latest product status information is available on the Internet at URL <http://www.nxp.com>.

10.2 Definitions

Draft — The document is a draft version only. The content is still under internal review and subject to formal approval, which may result in modifications or additions. NXP Semiconductors does not give any representations or warranties as to the accuracy or completeness of information included herein and shall have no liability for the consequences of use of such information.

Short data sheet — A short data sheet is an extract from a full data sheet with the same product type number(s) and title. A short data sheet is intended for quick reference only and should not be relied upon to contain detailed and full information. For detailed and full information see the relevant full data sheet, which is available on request via the local NXP Semiconductors sales office. In case of any inconsistency or conflict with the short data sheet, the full data sheet shall prevail.

Product specification — The information and data provided in a Product data sheet shall define the specification of the product as agreed between NXP Semiconductors and its customer, unless NXP Semiconductors and customer have explicitly agreed otherwise in writing. In no event however, shall an agreement be valid in which the NXP Semiconductors product is deemed to offer functions and qualities beyond those described in the Product data sheet.

10.3 Disclaimers

Limited warranty and liability — Information in this document is believed to be accurate and reliable. However, NXP Semiconductors does not give any representations or warranties, expressed or implied, as to the accuracy or completeness of such information and shall have no liability for the consequences of use of such information.

In no event shall NXP Semiconductors be liable for any indirect, incidental, punitive, special or consequential damages (including - without limitation - lost profits, lost savings, business interruption, costs related to the removal or replacement of any products or rework charges) whether or not such damages are based on tort (including negligence), warranty, breach of contract or any other legal theory.

Notwithstanding any damages that customer might incur for any reason whatsoever, NXP Semiconductors' aggregate and cumulative liability towards customer for the products described herein shall be limited in accordance with the *Terms and conditions of commercial sale* of NXP Semiconductors.

Right to make changes — NXP Semiconductors reserves the right to make changes to information published in this document, including without limitation specifications and product descriptions, at any time and without notice. This document supersedes and replaces all information supplied prior to the publication hereof.

Suitability for use — NXP Semiconductors products are not designed, authorized or warranted to be suitable for use in life support, life-critical or safety-critical systems or equipment, nor in applications where failure or

malfunction of an NXP Semiconductors product can reasonably be expected to result in personal injury, death or severe property or environmental damage. NXP Semiconductors accepts no liability for inclusion and/or use of NXP Semiconductors products in such equipment or applications and therefore such inclusion and/or use is at the customer's own risk.

Applications — Applications that are described herein for any of these products are for illustrative purposes only. NXP Semiconductors makes no representation or warranty that such applications will be suitable for the specified use without further testing or modification.

Customers are responsible for the design and operation of their applications and products using NXP Semiconductors products, and NXP Semiconductors accepts no liability for any assistance with applications or customer product design. It is customer's sole responsibility to determine whether the NXP Semiconductors product is suitable and fit for the customer's applications and products planned, as well as for the planned application and use of customer's third party customer(s). Customers should provide appropriate design and operating safeguards to minimize the risks associated with their applications and products.

NXP Semiconductors does not accept any liability related to any default, damage, costs or problem which is based on any weakness or default in the customer's applications or products, or the application or use by customer's third party customer(s). Customer is responsible for doing all necessary testing for the customer's applications and products using NXP Semiconductors products in order to avoid a default of the applications and the products or of the application or use by customer's third party customer(s). NXP does not accept any liability in this respect.

Limiting values — Stress above one or more limiting values (as defined in the Absolute Maximum Ratings System of IEC 60134) will cause permanent damage to the device. Limiting values are stress ratings only and (proper) operation of the device at these or any other conditions above those given in the Recommended operating conditions section (if present) or the Characteristics sections of this document is not warranted. Constant or repeated exposure to limiting values will permanently and irreversibly affect the quality and reliability of the device.

Terms and conditions of commercial sale — NXP Semiconductors products are sold subject to the general terms and conditions of commercial sale, as published at <http://www.nxp.com/profile/terms>, unless otherwise agreed in a valid written individual agreement. In case an individual agreement is concluded only the terms and conditions of the respective agreement shall apply. NXP Semiconductors hereby expressly objects to applying the customer's general terms and conditions with regard to the purchase of NXP Semiconductors products by customer.

No offer to sell or license — Nothing in this document may be interpreted or construed as an offer to sell products that is open for acceptance or the grant, conveyance or implication of any license under any copyrights, patents or other industrial or intellectual property rights.

Export control — This document as well as the item(s) described herein may be subject to export control regulations. Export might require a prior authorization from competent authorities.

Quick reference data — The Quick reference data is an extract of the product data given in the Limiting values and Characteristics sections of this document, and as such is not complete, exhaustive or legally binding.

Non-automotive qualified products — Unless this data sheet expressly states that this specific NXP Semiconductors product is automotive qualified, the product is not suitable for automotive use. It is neither qualified nor tested in accordance with automotive testing or application requirements. NXP Semiconductors accepts no liability for inclusion and/or use of non-automotive qualified products in automotive equipment or applications.

In the event that customer uses the product for design-in and use in automotive applications to automotive specifications and standards, customer (a) shall use the product without NXP Semiconductors' warranty of the

product for such automotive applications, use and specifications, and (b) whenever customer uses the product for automotive applications beyond NXP Semiconductors' specifications such use shall be solely at customer's own risk, and (c) customer fully indemnifies NXP Semiconductors for any liability, damages or failed product claims resulting from customer design and use of the product for automotive applications beyond NXP Semiconductors' standard warranty and NXP Semiconductors' product specifications.

10.4 Trademarks

Notice: All referenced brands, product names, service names and trademarks are the property of their respective owners.

11. Contact information

For more information, please visit: <http://www.nxp.com>

For sales office addresses, please send an email to: salesaddresses@nxp.com

12. Contents

1 Product profile 1

1.1 General description 1

1.2 Features and benefits 1

1.3 Applications 1

2 Pinning information 2

3 Ordering information 2

4 Marking 2

5 Limiting values 3

6 Characteristics 4

7 Application information 5

7.1 Insertion loss 5

7.2 Crosstalk 7

7.3 USIM and SIM interface application
schematic 9

7.4 Compatible devices in WLCSP 10

8 Package outline 11

9 Revision history 12

10 Legal information 13

10.1 Data sheet status 13

10.2 Definitions 13

10.3 Disclaimers 13

10.4 Trademarks 14

11 Contact information 14

12 Contents 15

Please be aware that important notices concerning this document and the product(s) described herein, have been included in section 'Legal information'.

© NXP B.V. 2011. All rights reserved.

For more information, please visit: <http://www.nxp.com>
For sales office addresses, please send an email to: salesaddresses@nxp.com

Date of release: 12 October 2011
Document identifier: IP4264CZ8-10_20_40-TTL