



Chipsmall Limited consists of a professional team with an average of over 10 year of expertise in the distribution of electronic components. Based in Hongkong, we have already established firm and mutual-benefit business relationships with customers from,Europe,America and south Asia,supplying obsolete and hard-to-find components to meet their specific needs.

With the principle of “Quality Parts,Customers Priority,Honest Operation,and Considerate Service”,our business mainly focus on the distribution of electronic components. Line cards we deal with include Microchip,ALPS,ROHM,Xilinx,Pulse,ON,Everlight and Freescale. Main products comprise IC,Modules,Potentiometer,IC Socket,Relay,Connector.Our parts cover such applications as commercial,industrial, and automotives areas.

We are looking forward to setting up business relationship with you and hope to provide you with the best service and solution. Let us make a better world for our industry!



Contact us

Tel: +86-755-8981 8866 Fax: +86-755-8427 6832

Email & Skype: info@chipsmall.com Web: www.chipsmall.com

Address: A1208, Overseas Decoration Building, #122 Zhenhua RD., Futian, Shenzhen, China



CoolMOS™ Power Transistor
Features

- Lowest figure-of-merit $R_{ON} \times Q_g$
- Ultra low gate charge
- Extreme dv/dt rated
- High peak current capability
- Qualified for industrial grade applications according to JEDEC¹⁾
- Pb-free lead plating; RoHS compliant; Halogen free mold compound

Product Summary

$V_{DS} @ T_{j,max}$	650	V
$R_{DS(on),max}$	0.299	Ω
$Q_{g,typ}$	22	nC

CoolMOS CP is specially designed for:

Hard switching SMPS topologies

PG-TO262

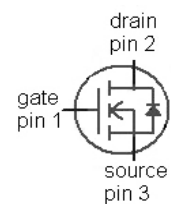

Type	Package	Ordering Code	Marking
IPI60R299CP	PG-TO262	SP000103249	6R299P

Maximum ratings, at $T_j=25^\circ\text{C}$, unless otherwise specified

Parameter	Symbol	Conditions	Value	Unit
Continuous drain current	I_D	$T_C=25^\circ\text{C}$	11	A
		$T_C=100^\circ\text{C}$	7	
Pulsed drain current ²⁾	$I_{D,pulse}$	$T_C=25^\circ\text{C}$	34	
Avalanche energy, single pulse	E_{AS}	$I_D=4.4\text{ A}, V_{DD}=50\text{ V}$	290	mJ
Avalanche energy, repetitive $t_{AR}^{2),3)}$	E_{AR}	$I_D=4.4\text{ A}, V_{DD}=50\text{ V}$	0.44	
Avalanche current, repetitive $t_{AR}^{2),3)}$	I_{AR}		4.4	A
MOSFET dv/dt ruggedness	dv/dt	$V_{DS}=0\dots 480\text{ V}$	50	V/ns
Gate source voltage	V_{GS}	static	± 20	V
		AC ($f > 1\text{ Hz}$)	± 30	
Power dissipation	P_{tot}	$T_C=25^\circ\text{C}$	96	W
Operating and storage temperature	T_j, T_{stg}		-55 ... 150	$^\circ\text{C}$

Maximum ratings, at $T_j=25\text{ °C}$, unless otherwise specified

Parameter	Symbol	Conditions	Value	Unit
Continuous diode forward current	I_S	$T_C=25\text{ °C}$	6.6	A
Diode pulse current ²⁾	$I_{S,pulse}$		34	
Reverse diode dv/dt ⁴⁾	dv/dt		15	V/ns

Parameter	Symbol	Conditions	Values			Unit
			min.	typ.	max.	

Thermal characteristics

Thermal resistance, junction - case	R_{thJC}		-	-	1.3	K/W
Thermal resistance, junction - ambient	R_{thJA}	leaded	-	-	62	
Soldering temperature, wavesoldering only allowed at leads	T_{sold}	1.6 mm (0.063 in.) from case for 10 s	-	-	260	°C

Electrical characteristics, at $T_j=25\text{ °C}$, unless otherwise specified
Static characteristics

Drain-source breakdown voltage	$V_{(BR)DSS}$	$V_{GS}=0\text{ V}, I_D=250\text{ }\mu\text{A}$	600	-	-	V
Gate threshold voltage	$V_{GS(th)}$	$V_{DS}=V_{GS}, I_D=0,44\text{ mA}$	2.5	3	3.5	
Zero gate voltage drain current	I_{DSS}	$V_{DS}=600\text{ V}, V_{GS}=0\text{ V}, T_j=25\text{ °C}$	-	-	1	μA
		$V_{DS}=600\text{ V}, V_{GS}=0\text{ V}, T_j=150\text{ °C}$	-	10	-	
Gate-source leakage current	I_{GSS}	$V_{GS}=20\text{ V}, V_{DS}=0\text{ V}$	-	-	100	nA
Drain-source on-state resistance	$R_{DS(on)}$	$V_{GS}=10\text{ V}, I_D=6.6\text{ A}, T_j=25\text{ °C}$	-	0.27	0.299	Ω
		$V_{GS}=10\text{ V}, I_D=6.6\text{ A}, T_j=150\text{ °C}$	-	0.73		
Gate resistance	R_G	$f=1\text{ MHz}$, open drain	-	1.9	-	Ω

Parameter	Symbol	Conditions	Values			Unit
			min.	typ.	max.	

Dynamic characteristics

Input capacitance	C_{iss}	$V_{GS}=0\text{ V}, V_{DS}=100\text{ V},$ $f=1\text{ MHz}$	-	1100	-	pF
Output capacitance	C_{oss}		-	60	-	
Effective output capacitance, energy related ⁵⁾	$C_{o(er)}$	$V_{GS}=0\text{ V}, V_{DS}=0\text{ V}$ to 480 V	-	46	-	
Effective output capacitance, time related ⁶⁾	$C_{o(tr)}$		-	120	-	
Turn-on delay time	$t_{d(on)}$	$V_{DD}=400\text{ V},$ $V_{GS}=10\text{ V}, I_D=6,6\text{ A},$ $R_G=4,3\ \Omega$	-	10	-	ns
Rise time	t_r		-	5	-	
Turn-off delay time	$t_{d(off)}$		-	40	-	
Fall time	t_f		-	5	-	

Gate Charge Characteristics

Gate to source charge	Q_{gs}	$V_{DD}=400\text{ V}, I_D=6.6\text{ A},$ $V_{GS}=0\text{ to }10\text{ V}$	-	5	-	nC
Gate to drain charge	Q_{gd}		-	7.6	-	
Gate charge total	Q_g		-	22	29	
Gate plateau voltage	$V_{plateau}$		-	5.0	-	V

Reverse Diode

Diode forward voltage	V_{SD}	$V_{GS}=0\text{ V}, I_F=6.6\text{ A},$ $T_j=25\text{ }^\circ\text{C}$	-	0.9	1.2	V
Reverse recovery time	t_{rr}	$V_R=400\text{ V}, I_F=I_S,$ $di_F/dt=100\text{ A}/\mu\text{s}$	-	300	-	ns
Reverse recovery charge	Q_{rr}		-	3.9	-	μC
Peak reverse recovery current	I_{rrm}		-	26	-	A

¹⁾ J-STD20 and JESD22

²⁾ Pulse width t_p limited by $T_{j,max}$

³⁾ Repetitive avalanche causes additional power losses that can be calculated as $P_{AV}=E_{AR} \cdot f$.

⁴⁾ $I_{SD} \leq I_D, di/dt \leq 200\text{ A}/\mu\text{s}, V_{Dlink}=400\text{ V}, V_{peak} < V_{(BR)DSS}, T_j < T_{j,max}$, identical low side and high side switch.

⁵⁾ $C_{o(er)}$ is a fixed capacitance that gives the same stored energy as C_{oss} while V_{DS} is rising from 0 to 80% V_{DSS} .

⁶⁾ $C_{o(tr)}$ is a fixed capacitance that gives the same charging time as C_{oss} while V_{DS} is rising from 0 to 80% V_{DSS} .

1 Power dissipation

$P_{tot}=f(T_C)$

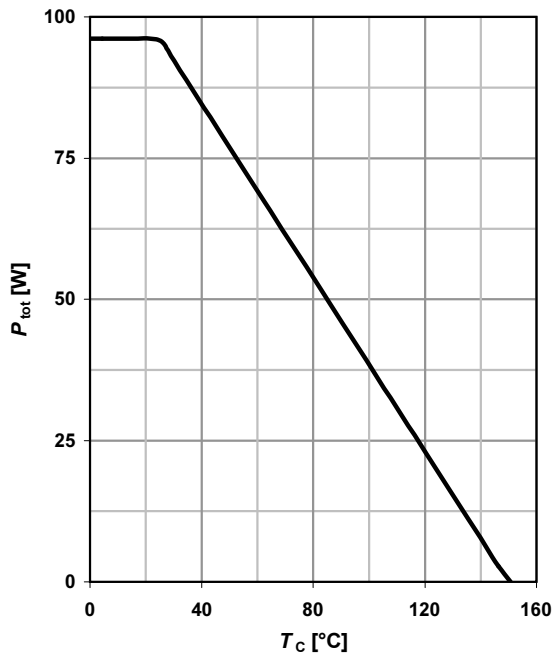

2 Safe operating area

$I_D=f(V_{DS}); T_C=25\text{ °C}; D=0$

parameter: t_p

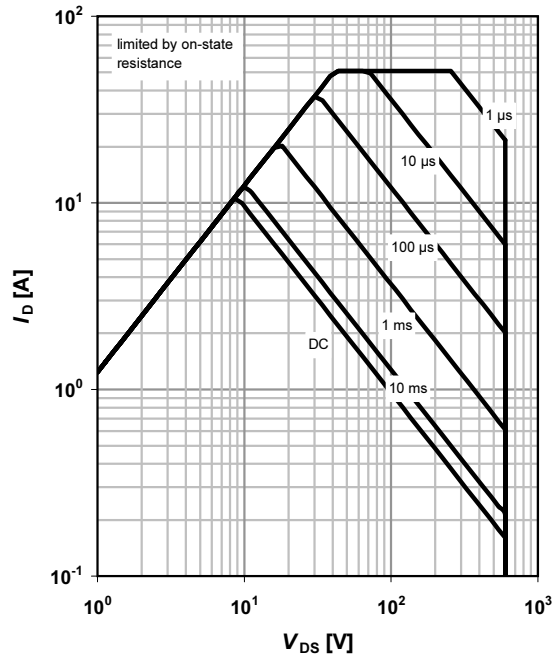

3 Max. transient thermal impedance

$Z_{thJC}=f(t_p)$

parameter: $D=t_p/T$

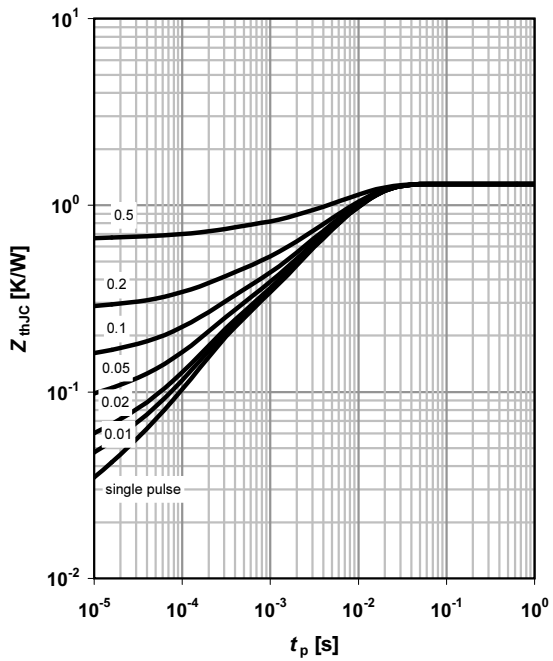

4 Typ. output characteristics

$I_D=f(V_{DS}); T_J=25\text{ °C}$

parameter: V_{GS}

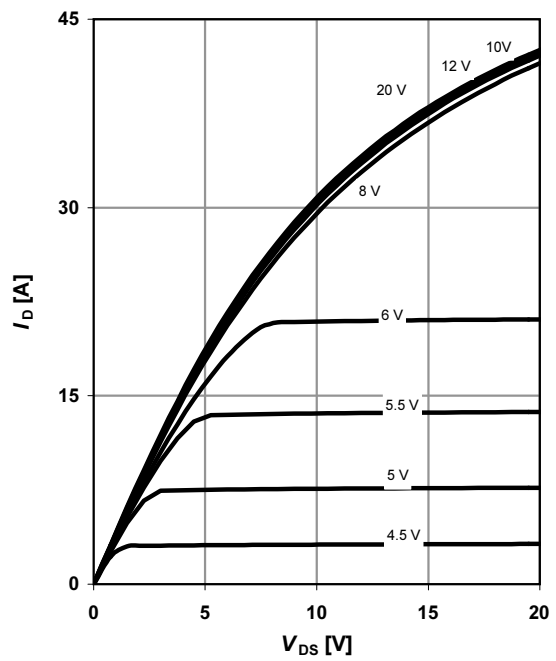

5 Typ. output characteristics

$I_D = f(V_{DS}); T_j = 150\text{ }^\circ\text{C}$

parameter: V_{GS}

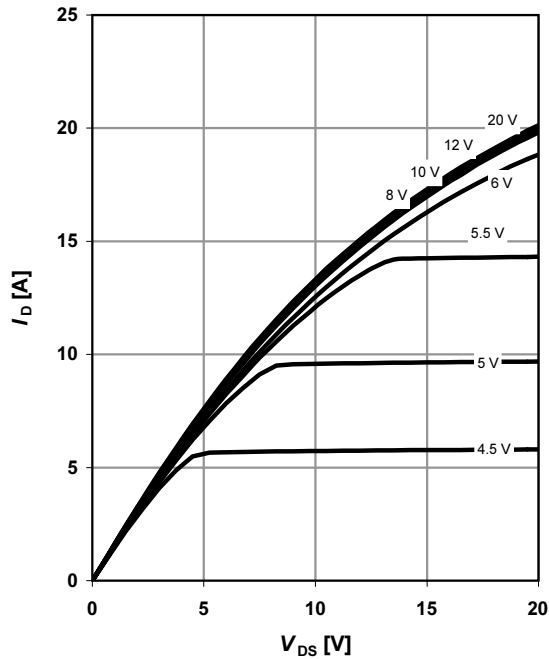

6 Typ. drain-source on-state resistance

$R_{DS(on)} = f(I_D); T_j = 150\text{ }^\circ\text{C}$

parameter: V_{GS}

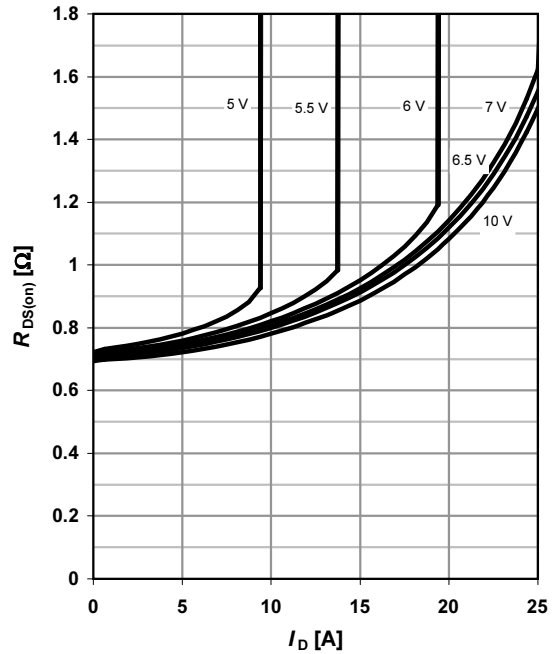

7 Drain-source on-state resistance

$R_{DS(on)} = f(T_j); I_D = 6.6\text{ A}; V_{GS} = 10\text{ V}$

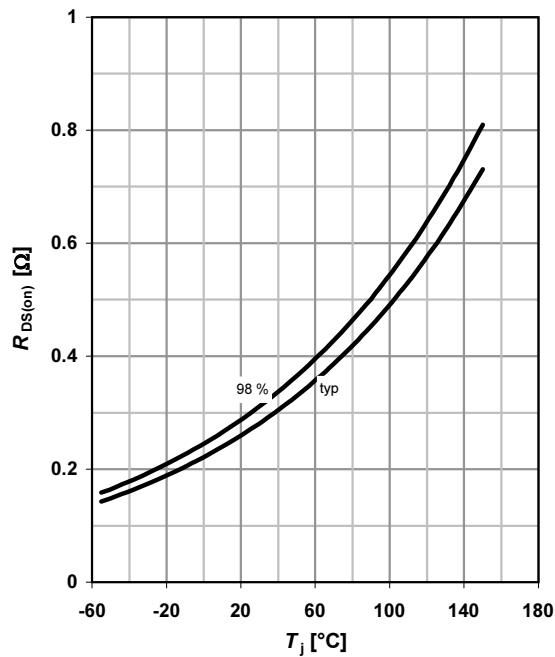

8 Typ. transfer characteristics

$I_D = f(V_{GS}); |V_{DS}| > 2|I_D|R_{DS(on)max}$

parameter: T_j

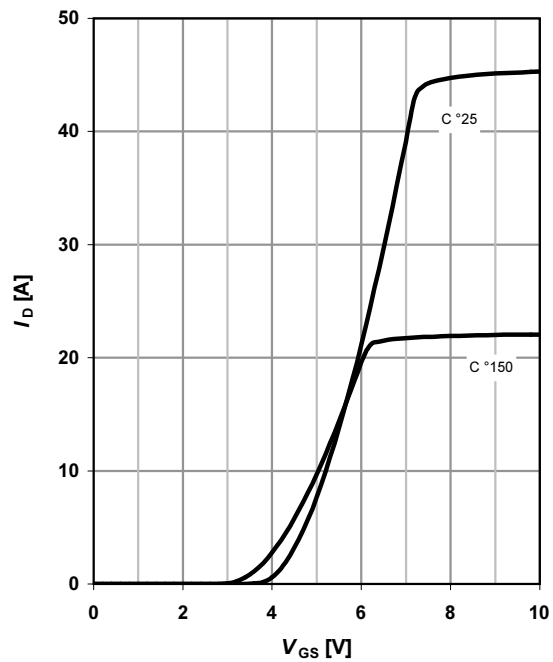

9 Typ. gate charge

$V_{GS}=f(Q_{gate}); I_D=6.6 \text{ A pulsed}$

parameter: V_{DD}

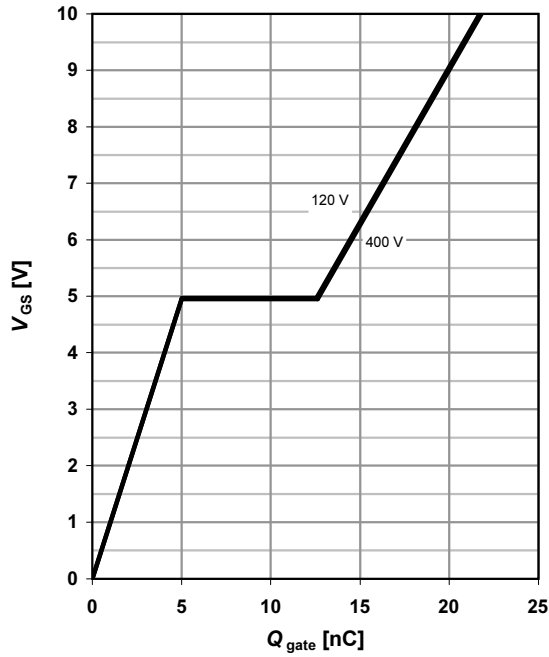

10 Forward characteristics of reverse diode

$I_F=f(V_{SD})$

parameter: T_j

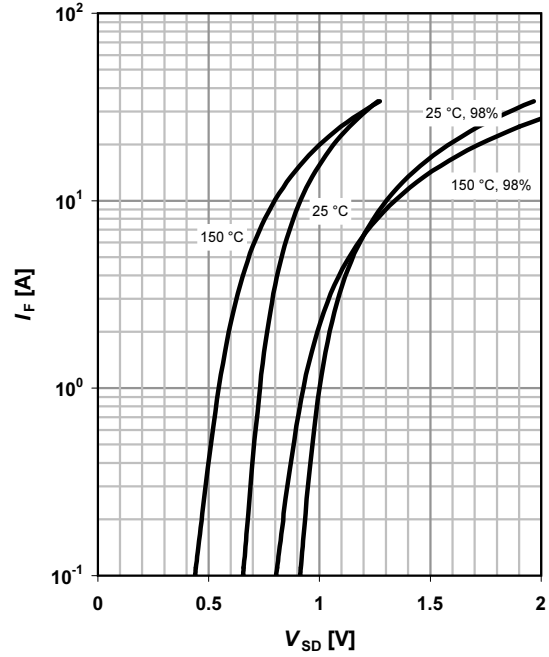

11 Avalanche energy

$E_{AS}=f(T_j); I_D=4.4 \text{ A}; V_{DD}=50 \text{ V}$

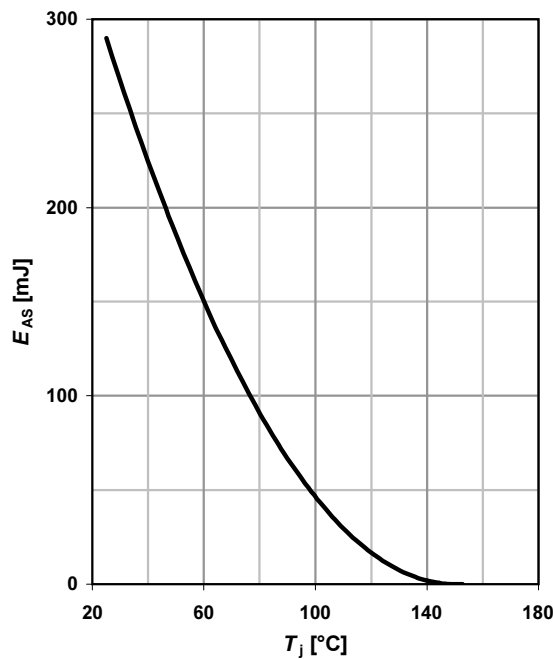

12 Drain-source breakdown voltage

$V_{BR(DSS)}=f(T_j); I_D=0.25 \text{ mA}$

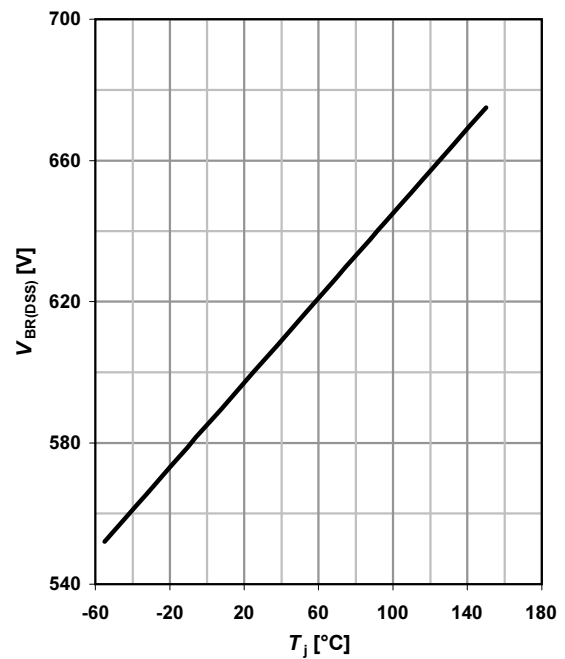

13 Typ. capacitances

$$C = f(V_{DS}); V_{GS} = 0 \text{ V}; f = 1 \text{ MHz}$$

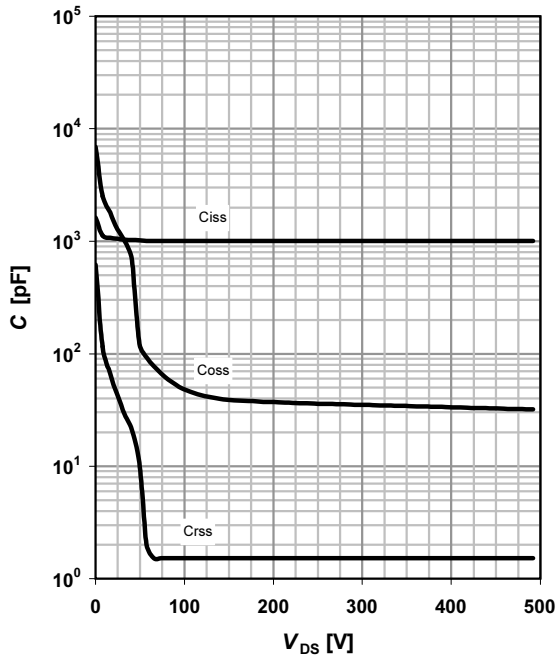

14 Typ. Coss stored energy

$$E_{oss} = f(V_{DS})$$

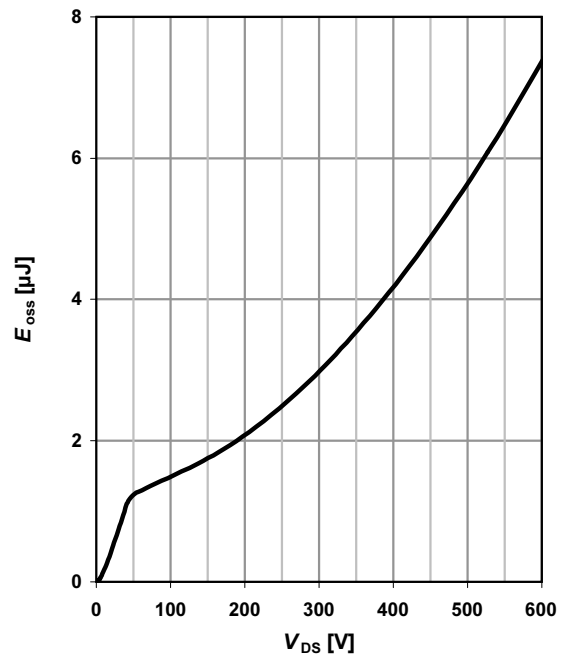

Definition of diode switching characteristics

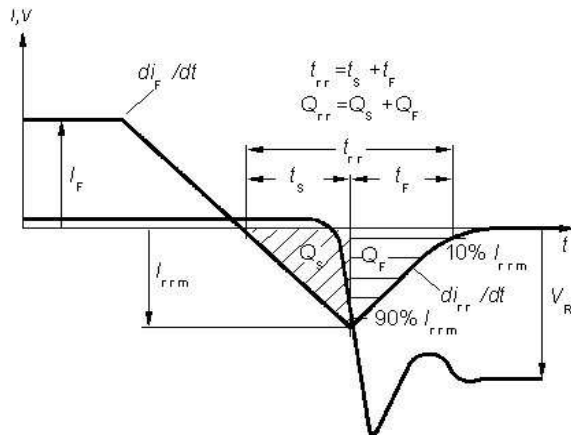

PG-TO262-3-1: Outlines

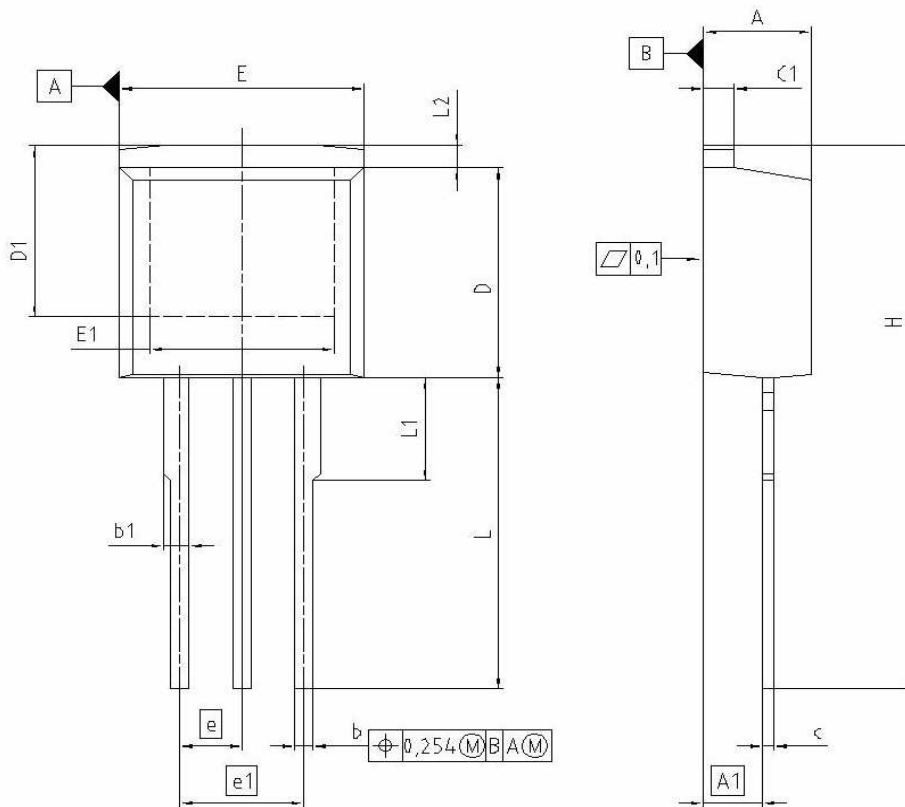

DIM	MILLIMETERS		INCHES	
	MIN	MAX	MIN	MAX
A	4.300	4.500	0.169	0.177
A1	2.150	2.650	0.085	0.104
b	0.650	0.850	0.026	0.033
b1	0.635	1.400	0.025	0.055
c	0.400	0.600	0.016	0.024
c1	1.170	1.370	0.046	0.054
D	9.050	9.450	0.356	0.372
D1	6.900	7.650	0.272	0.301
E	9.800	10.200	0.386	0.402
E1	7.250	8.600	0.285	0.339
e	2.540		0.100	
e1	5.080		0.200	
N	3		3	
L	13.000	14.000	0.512	0.551
L1	4.350	4.750	0.171	0.187
L2	0.700	1.300	0.028	0.051

REFERENCE JEDEC TO262
SCALE
EUROPEAN PROJECTION
ISSUE DATE 01-06-2005
FILE TO262_1

Dimensions in mm/inches

Published by
Infineon Technologies AG
81726 München, Germany
© Infineon Technologies AG 2006.
All Rights Reserved.

Legal Disclaimer

The information given in this document shall in no event be regarded as a guarantee of conditions or characteristics. With respect to any examples or hints given herein, any typical values stated herein and/or any information regarding the application of the device, Infineon Technologies hereby disclaims any and all warranties and liabilities of any kind, including without limitation, warranties of non-infringement of intellectual property rights of any third party.

Information

For further information on technology, delivery terms and conditions and prices, please contact the nearest Infineon Technologies Office (www.infineon.com).

Warnings

Due to technical requirements, components may contain dangerous substances. For information on the types in question, please contact the nearest Infineon Technologies Office. The Infineon Technologies component described in this Data Sheet may be used in life-support devices or systems and/or automotive, aviation and aerospace applications or systems only with the express written approval of Infineon Technologies, if a failure of such components can reasonably be expected to cause the failure of that life-support, automotive, aviation and aerospace device or system or to affect the safety or effectiveness of that device or system. Life support devices or systems are intended to be implanted in the human body or to support and/or maintain and sustain and/or protect human life. If they fail, it is reasonable to assume that the health of the user or other persons may be endangered.