



Chipsmall Limited consists of a professional team with an average of over 10 year of expertise in the distribution of electronic components. Based in Hongkong, we have already established firm and mutual-benefit business relationships with customers from,Europe,America and south Asia,supplying obsolete and hard-to-find components to meet their specific needs.

With the principle of “Quality Parts,Customers Priority,Honest Operation,and Considerate Service”,our business mainly focus on the distribution of electronic components. Line cards we deal with include Microchip,ALPS,ROHM,Xilinx,Pulse,ON,Everlight and Freescale. Main products comprise IC,Modules,Potentiometer,IC Socket,Relay,Connector.Our parts cover such applications as commercial,industrial, and automotives areas.

We are looking forward to setting up business relationship with you and hope to provide you with the best service and solution. Let us make a better world for our industry!



Contact us

Tel: +86-755-8981 8866 Fax: +86-755-8427 6832

Email & Skype: info@chipsmall.com Web: www.chipsmall.com

Address: A1208, Overseas Decoration Building, #122 Zhenhua RD., Futian, Shenzhen, China



IPS031R

FULLY PROTECTED POWER MOSFET SWITCH

Features

- Over temperature shutdown
- Over current shutdown
- Active clamp
- Low current & logic level input
- E.S.D protection

Description

The IPS031R are fully protected three terminal SMART POWER MOSFETs that feature over-current, over-temperature, ESD protection and drain to source active clamp. These devices combine a HEXFET® POWER MOSFET and a gate driver. They offer full protection and high reliability required in harsh environments. The driver allows short switching times and provides efficient protection by turning OFF the power MOSFET when the temperature exceeds 165°C or when the drain current reaches 14A. The device restarts once the input is cycled. The avalanche capability is significantly enhanced by the active clamp and covers most inductive load demagnetizations.

Product Summary

$R_{ds(on)}$	60mΩ (max)
V_{clamp}	50V
$I_{shutdown}$	14A
T_{on}/T_{off}	1.5μs

Package

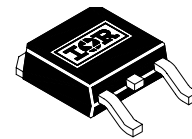

3-Lead D-Pak

Typical Connection

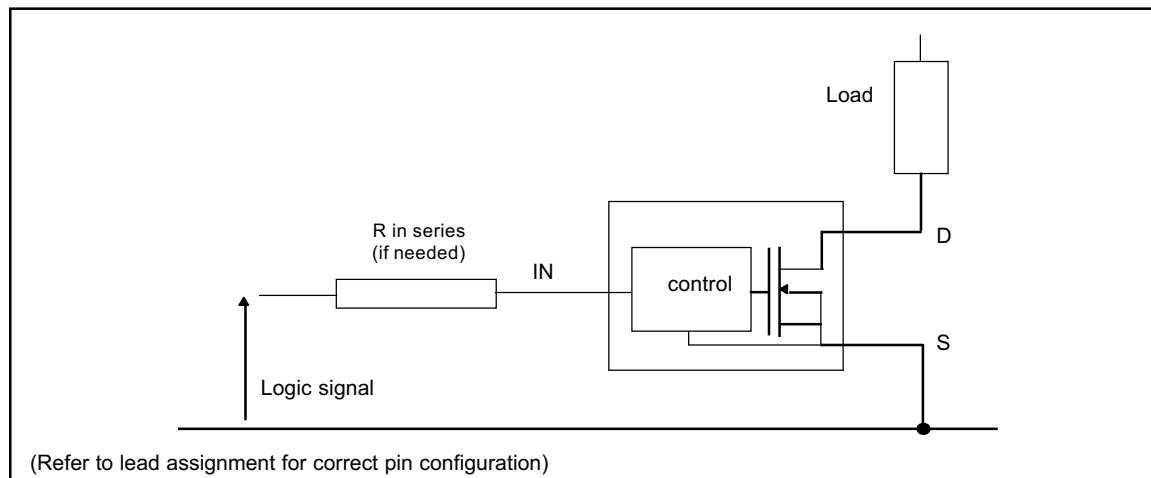

Absolute Maximum Ratings

Absolute maximum ratings indicate sustained limits beyond which damage to the device may occur. All voltage parameters are referenced to SOURCE lead. ($T_{Ambient} = 25^{\circ}C$ unless otherwise specified). PCB mounting uses the standard footprint with 70 μ m copper thickness.

Symbol	Parameter	Min.	Max.	Units	Test Conditions	
V_{ds}	Maximum drain to source voltage	—	47	V		
V_{in}	Maximum input voltage	-0.3	7			
$I_{in, max}$	Maximum IN current	-10	+10	mA		
$I_{sd cont.}$	Diode max. continuous current ⁽¹⁾ rth=100°C/W	—	1.6	A	D-Pak Std footprint	
		rth=5°C/W	—		18	D-Pak with Rth=5°C/W
		rth=50°C/W	—		3	D-Pak with sq. footprint
$I_{sd pulsed}$	Diode max. pulsed current ⁽¹⁾	—	18			
P_d	Maximum power dissipation ⁽¹⁾ rth=50°C/W	—	2.5	W		
		rth=100°C/W	—		1.25	
ESD1	Electrostatic discharge voltage (Human Body)	—	4		C=100pF, R=1500 Ω ,	
ESD2	Electrostatic discharge voltage (Machine Model)	—	0.5	kV	C=200pF, R=0 Ω , L=10 μ H	
$T_{stor.}$	Max. storage temperature	-55	150			
$T_j max.$	Max. junction temperature	-40	+150			
T_{lead}	Lead temperature (soldering, 10 seconds)	—	300	°C		

Thermal Characteristics

Symbol	Parameter	Min.	Typ.	Max.	Units	Test Conditions
$R_{th 1}$	Thermal resistance with standard footprint	—	100	—	°C/W	D-PAK
$R_{th 2}$	Thermal resistance with 1" square footprint	—	50	—		
$R_{th 3}$	Thermal resistance junction to case	—	3	—		

Recommended Operating Conditions

These values are given for a quick design. For operation outside these conditions, please consult the application notes.

Symbol	Parameter	Min.	Max.	Units
$V_{ds (max)}$	Continuous drain to source voltage	—	35	V
V_{IH}	High level input voltage	4	6	
V_{IL}	Low level input voltage	0	0.5	
I_{ds} $T_{amb}=85^{\circ}C$	Continuous drain current $T_{Ambient} = 85^{\circ}C$, $I_N = 5V$, $r_{th} = 50^{\circ}C/W$, $T_j = 125^{\circ}C$ 1" sq. footprint	—	3.3	A
		$T_{Ambient} = 85^{\circ}C$, $I_N = 5V$, $r_{th} = 100^{\circ}C/W$, $T_j = 125^{\circ}C$ Std. footprint	—	
R_{in}	Recommended resistor in series with IN pin	0.2	5	k Ω
$T_{r-in(max)}$	Max recommended rise time for IN signal (see fig. 2)	—	1	μ S
$F_r-I_{sc}^{(2)}$	Max. frequency in short circuit condition ($V_{cc} = 14V$)	0	1	kHz

(1) Limited by junction temperature (pulsed current limited also by internal wiring)

(2) Operations at higher switching frequencies is possible. See Application. Notes.

Static Electrical Characteristics

(T_j = 25°C unless otherwise specified.)

Symbol	Parameter	Min.	Typ.	Max.	Units	Test Conditions
R _{ds(on)}	ON state resistance T _j = 25°C	20	45	60	mΩ	V _{in} = 5V, I _{ds} = 1A
R _{ds(on)}	ON state resistance T _j = 150°C	—	75	100		
I _{dss} @T _j =25°C	Drain to source leakage current	0	0.5	25	μA	V _{cc} = 14V, T _j = 25°C
I _{dss2} @T _j =25°C	Drain to source leakage current	0	5	50		V _{cc} = 40V, T _j = 25°C
V _{clamp 1}	Drain to source clamp voltage 1	47	52	56	V	I _d = 20mA (see Fig.3 & 4)
V _{clamp 2}	Drain to source clamp voltage 2	50	53	60		I _d =I _{shutdown} (see Fig.3 & 4)
V _{in clamp}	IN to source clamp voltage	7	8.1	9.5		I _{in} = 1 mA
V _{th}	IN threshold voltage	1	1.6	2		I _d = 50mA, V _{ds} = 14V
I _{in, -on}	ON state IN positive current	25	90	200	μA	V _{in} = 5V
I _{in, -off}	OFF state IN positive current	50	130	250		V _{in} = 5V over-current triggered

Switching Electrical Characteristics

V_{cc} = 14V, Resistive Load = 5Ω, R_{input} = 50Ω, 100μs pulse, T_j = 25°C, (unless otherwise specified).

Symbol	Parameter	Min.	Typ.	Max.	Units	Test Conditions
T _{on}	Turn-on delay time	0.05	0.3	0.6	μs	See figure 2
T _r	Rise time	0.4	1	2		
T _{rf}	Time to 130% final R _{ds(on)}	—	8	—		
T _{off}	Turn-off delay time	0.8	2	3.5	μs	See figure 2
T _f	Fall time	0.5	1.5	2.5		
Q _{in}	Total gate charge	—	11	—	nC	V _{in} = 5V

Protection Characteristics

Symbol	Parameter	Min.	Typ.	Max.	Units	Test Conditions
T _{sd}	Over temperature threshold	—	165	—	°C	See fig. 1
I _{sd}	Over current threshold	10	14	18	A	See fig. 1
V _{reset}	IN protection reset threshold	1.5	2.3	3	V	
T _{reset}	Time to reset protection	2	10	40	μs	V _{in} = 0V, T _j = 25°C
EOI_OT	Short circuit energy (see application note)	—	400	—	μJ	V _{cc} = 14V

IPS031R

Functional Block Diagram

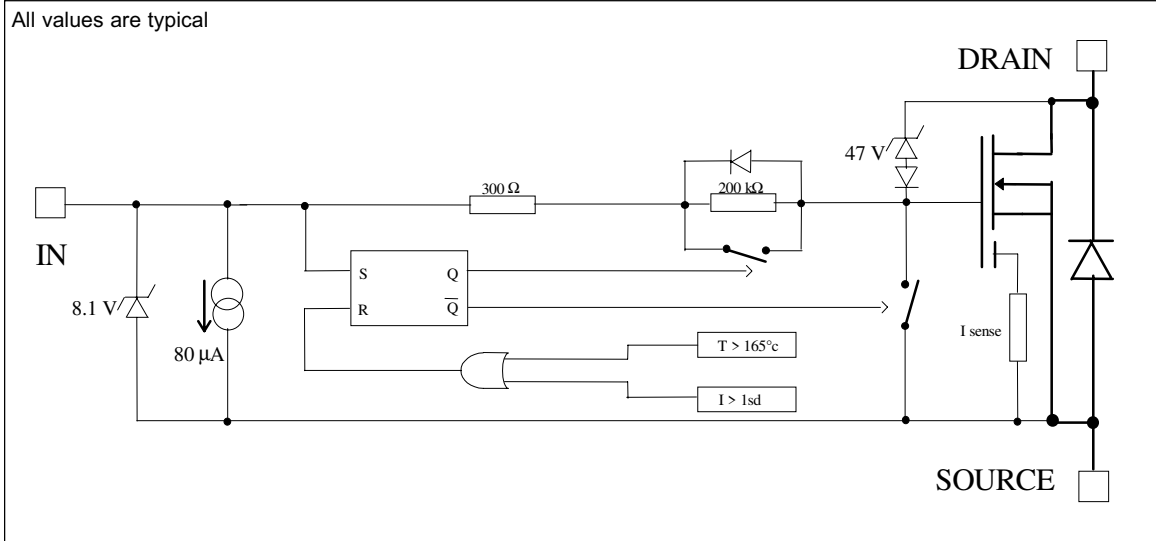

Lead Assignments

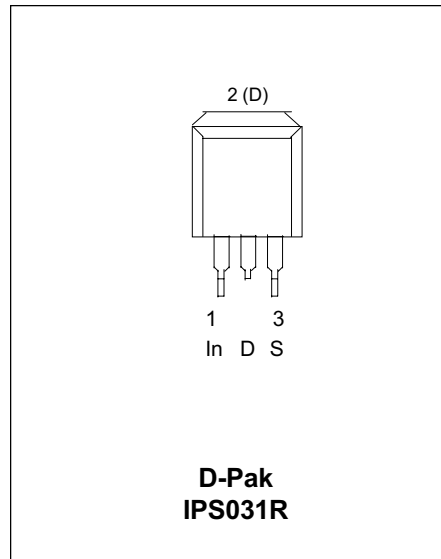

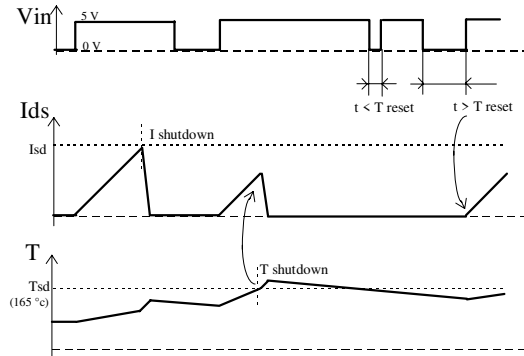

Figure 1 - Timing diagram

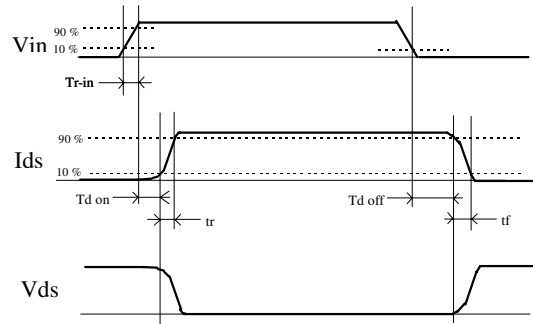

Figure 2 - IN rise time & switching time definitions

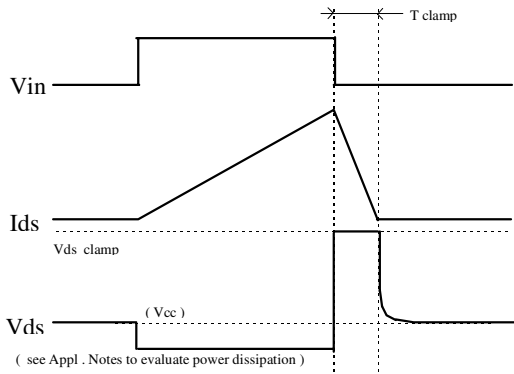

Figure 3 - Active clamp waveforms

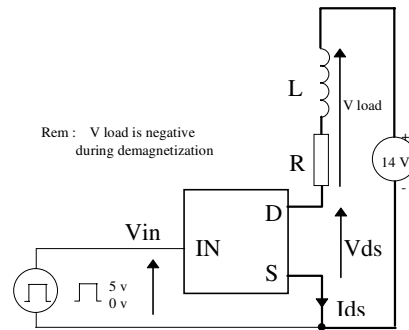

Figure 4 - Active clamp test circuit

All curves are typical values with standard footprints. Operating in the shaded area is not recommended.

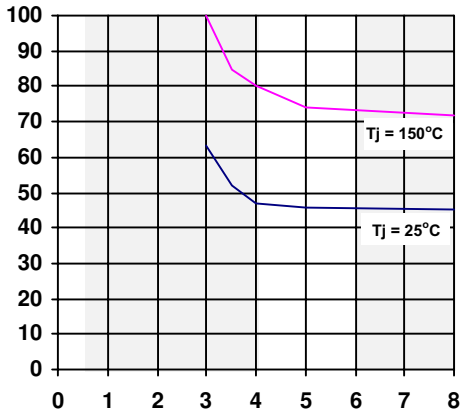

Figure 5 - Rds ON (mΩ) Vs Input Voltage (V)

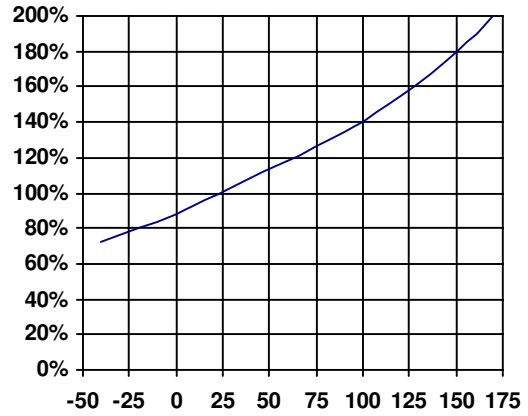

Figure 6 - Normalised Rds ON (%) Vs Tj (°C)

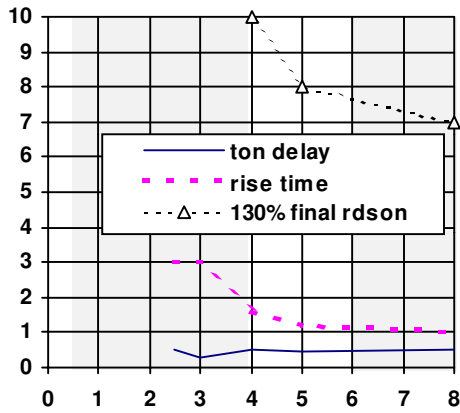

Figure 7 - Turn-ON Delay Time, Rise Time & Time to 130% final Rds(on) (us) Vs Input Voltage (V)

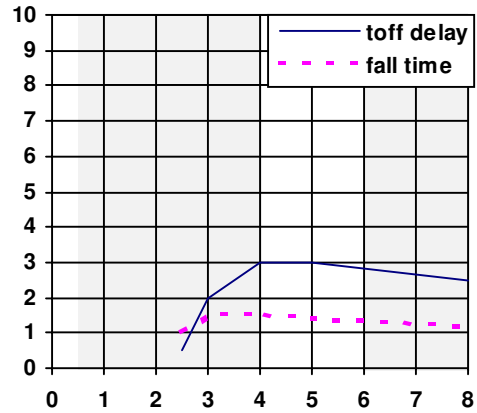

Figure 8 - Turn-OFF Delay Time & Fall Time (us) Vs Input Voltage (V)

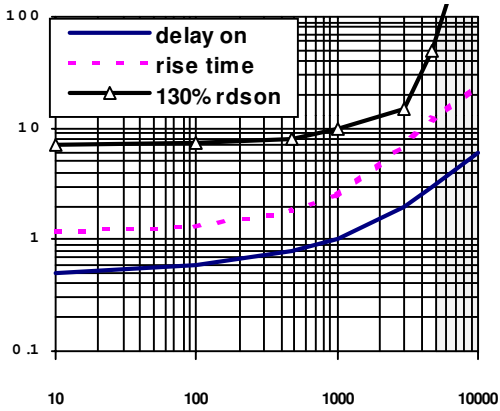

Figure 9 - Turn-ON Delay Time, Rise Time & Time to 130% final R_{ds(on)} (us) Vs IN Resistor (Ω)

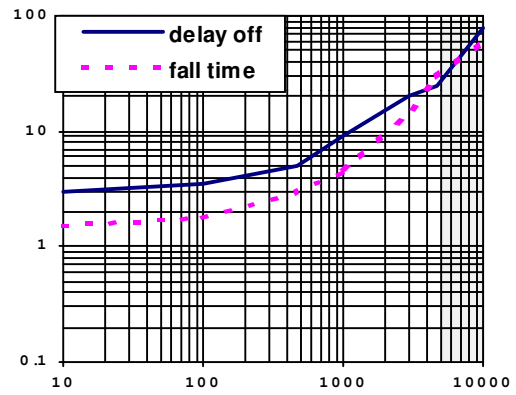

Figure 10 - Turn-OFF Delay Time & Fall Time (us) Vs IN Resistor (Ω)

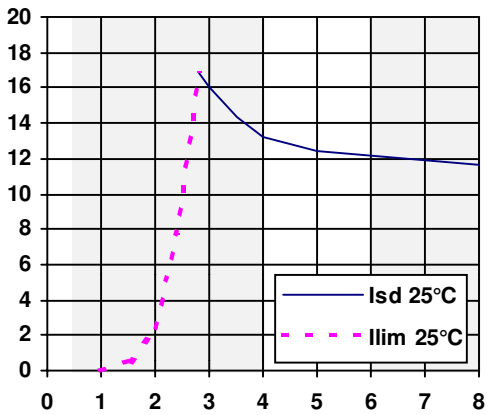

Figure 11 - Current limitation & I shutdown (A) Vs Vin (V)

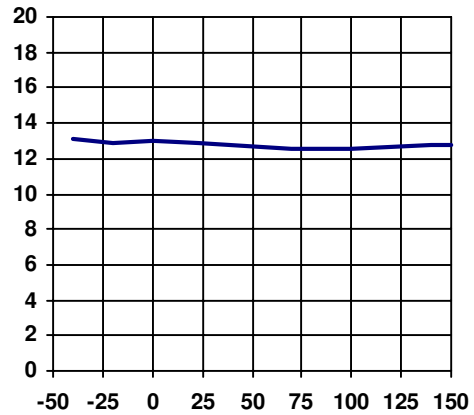

Figure 12 - I shutdown (A) Vs Temperature (°C)

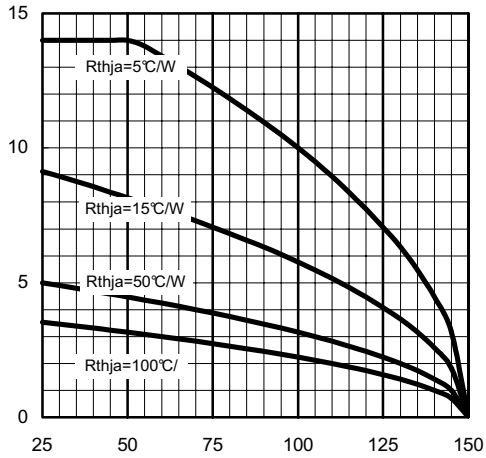

Figure 13 - Max. I load current (A) Vs Tamb (°C)
IPS031R

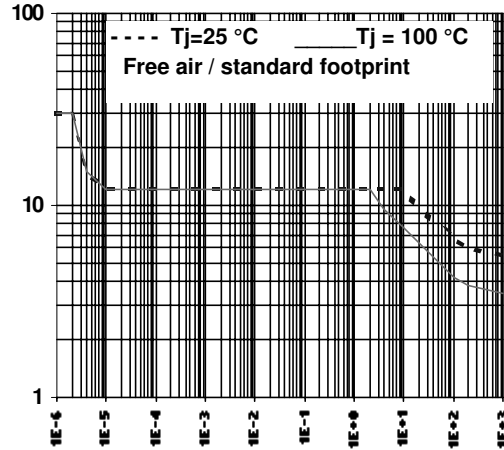

Figure 14 - Ids (A) Vs Protection Resp. Time (s)
IPS031R

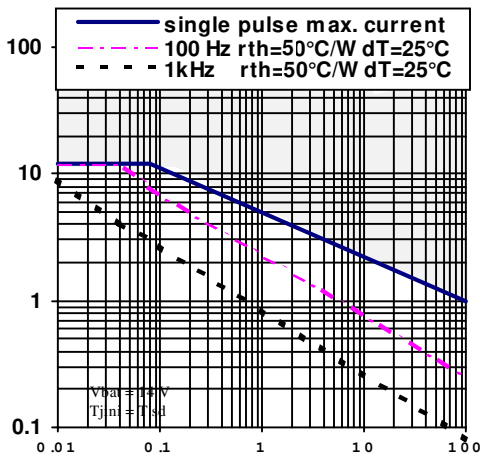

Figure 15 - Iclamp (A) Vs Inductive Load (mH)

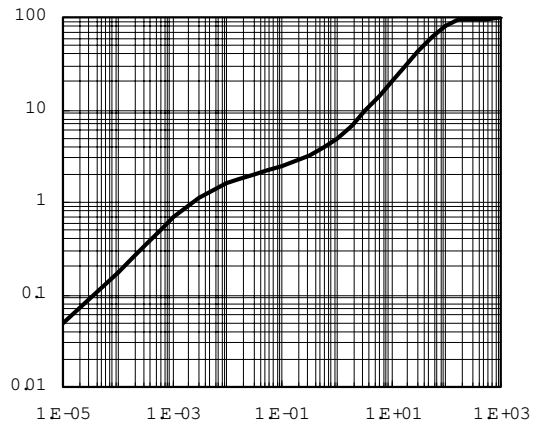

Fig.16 - Transient Thermal Impedance (°C/W)
Vs Time (s) - IPS031R

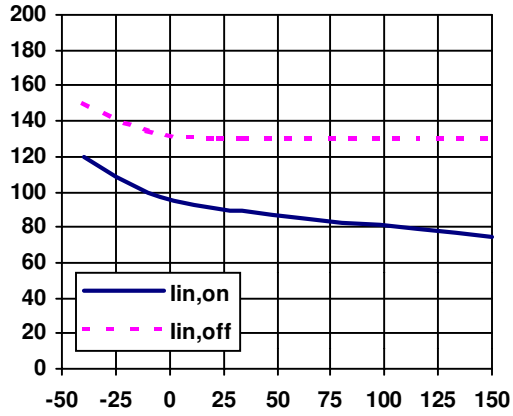

Figure 17 - Input current (µA) Vs Junction (°C)

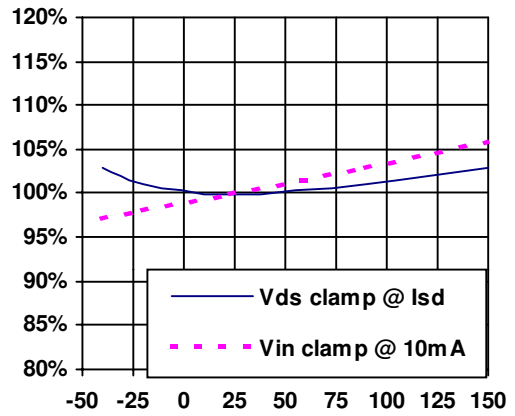

Figure 18 - Vin clamp and V clamp2 (%) Vs Tj (°C)

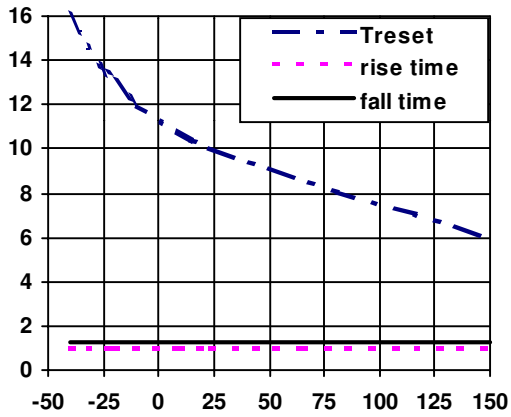
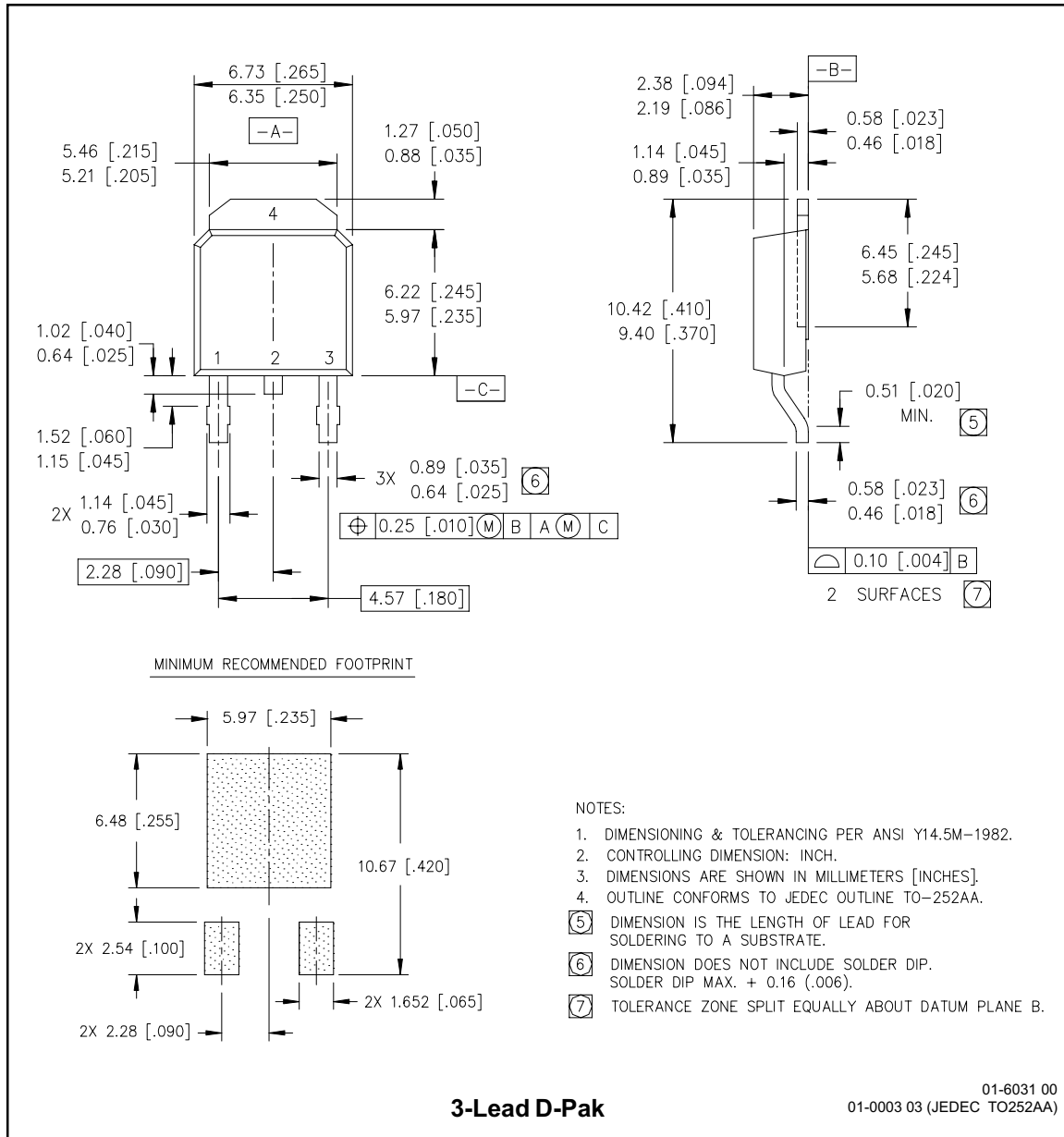
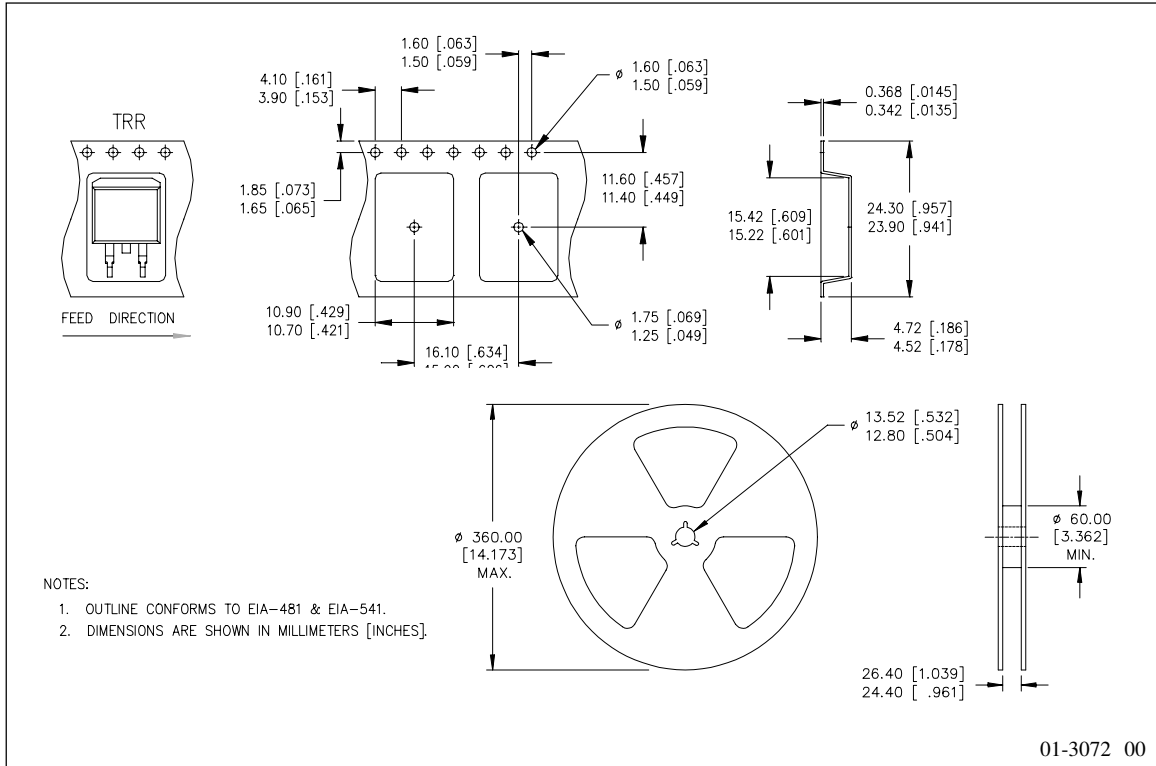

Figure 19 - Turn-on, Turn-off, and treset (µs) Vs Tj (°C)

Case Outline



Tape & Reel - D-PAK



Note: For the most current drawings please refer to the IR website at:
<http://www.irf.com/package/>