



Chipsmall Limited consists of a professional team with an average of over 10 year of expertise in the distribution of electronic components. Based in Hongkong, we have already established firm and mutual-benefit business relationships with customers from,Europe,America and south Asia,supplying obsolete and hard-to-find components to meet their specific needs.

With the principle of "Quality Parts,Customers Priority,Honest Operation,and Considerate Service",our business mainly focus on the distribution of electronic components. Line cards we deal with include Microchip,ALPS,ROHM,Xilinx,Pulse,ON,Everlight and Freescale. Main products comprise IC,Modules,Potentiometer,IC Socket,Relay,Connector.Our parts cover such applications as commercial,industrial, and automotives areas.

We are looking forward to setting up business relationship with you and hope to provide you with the best service and solution. Let us make a better world for our industry!



Contact us

Tel: +86-755-8981 8866 Fax: +86-755-8427 6832

Email & Skype: info@chipsmall.com Web: www.chipsmall.com

Address: A1208, Overseas Decoration Building, #122 Zhenhua RD., Futian, Shenzhen, China





IQS127D Datasheet

IQ Switch[®] - ProxSense[®] Series

Single Channel Capacitive Proximity/Touch Controller

The IQS127D ProxSense[®] IC is a fully integrated capacitive sensor with dual outputs (Touch and Proximity outputs).

Features

- Automatic Tuning Implementation (ATI) - Automatic adjustment for optimal performance.
- Internal Capacitor Implementation (ICI) – reference capacitor on-chip
- Supply voltage: 2.95V to 5.5V
- Minimum external components
- Data streaming option
- Advanced on-chip digital signal processing
- User selectable (OTP):
 - 4 Power Modes (15uA min)
 - IO sink / source
 - Time-out for stuck key
 - Output mode (Direct / Latch / Toggle)
 - Proximity and Touch Button sensitivity

RoHS2
Compliant

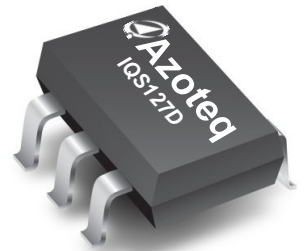

6 pin TSOT23-6
Representations only,
not actual markings

Keys:	Touch:	5mm x 5mm or larger (overlay thickness dependent)
	Proximity:	Various electrical options (wire / PCB trace / ITO / conductive foil)
Dielectric:	Material:	Various non-metal materials (i.e. glass, plastic, painted surfaces)
	Thickness:	6 mm plastic, 10 mm glass

Applications

- LCD, Plasma & LED TVs
- GSM cellular telephones – On ear detection / touch keys
- LED flashlights or headlamps
- White goods and appliances
- Office equipment, toys, sanitary ware
- Flame proof, hazardous environment Human Interface Devices
- Proximity detection enables backlighting activation
- Wake-up from standby applications
- Replacement for electromechanical switches
- Find-In-The-Dark (FITD) applications
- Automotive: Door pocket lighting, electric window control
- GUI trigger on Proximity detected

Available options

T_A	TSOT23-6
-40°C to 85°C	IQS127D



Contents

IQS127D DATASHEET	1
1 OVERVIEW	3
2 ANALOGUE FUNCTIONALITY.....	3
3 PACKAGING AND PIN-OUT	4
4 USER CONFIGURABLE OPTIONS.....	5
5 MEASURING CAPACITANCE USING THE <i>CHARGE TRANSFER</i> METHOD.....	7
6 DESCRIPTIONS OF USER OPTIONS	7
7 1-WIRE DATA STREAMING MODE.....	11
8 ANTENNA TUNING IMPLEMENTATION (ATI).....	13
9 ELECTRICAL SPECIFICATIONS	15
10 DATASHEET AND PART-NUMBER INFORMATION	21
11 CONTACT INFORMATION	24



1 Overview

The IQS127D is a single channel capacitive proximity and touch device which employs an internal voltage regulator and reference capacitor (Cs).

The IQS127D device has a dedicated pin for the connection of a sense antenna (Cx) and output pins for proximity events on POUT and touch events on TOUT. The output pins can be configured for various output methods including a serial data streaming option on TOUT.

Device configuration is determined by one time programmable (OTP) options.

The devices automatically track slow varying environmental changes via various filters, detect noise and has an automatic Antenna Tuning Implementation (ATI) to tune the device to the sense antenna.

1.1 Applicability

All specifications, except where specifically mentioned otherwise, provided by this datasheet are applicable to the following ranges:

- Temperature: -40C to +85C
- Supply voltage (V_{DDHI}): 2.95V to 5V

2 Analogue Functionality

The analogue circuitry measures the capacitance of a sense antenna attached to the Cx pin through a charge transfer process (refer to section 5) that is periodically initiated by the digital circuitry. The measuring process is referred to a conversion and consists of the discharging of reference capacitor and Cx, the charging of Cx and then a series of charge transfers from Cx to Cs until a trip voltage is reached. The number of charge transfers required to

reach the trip voltage is referred to as the current sample (CS).

The capacitance measurement circuitry makes use of an internal Cs and voltage reference (V_{REF}).

The analogue circuitry further provides functionality for:

- Power on reset (POR) detection.
- Brown out detection (BOD).
- Detection of a watch dog timer (WDT) expiry.



3 Packaging and Pin-out

The IQS127D is available in a TSOT23-6 package.

3.1 Pin-out

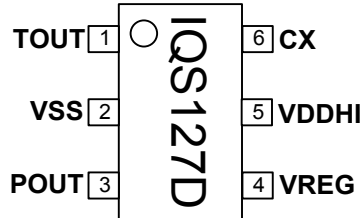

Figure 3.1 Pin-out of IQS127D package

Table 3.1 Pin-out description

IQS127D			
Pin	Name	Type	Function
1	TOUT	Digital Out	Touch Output
2	VSS	Ground	GND Reference
3	POUT	Digital Out	Proximity Output
4	VREG	Analogue Output	Internal Regulator Pin
5	VDDHI	Supply Input	Supply Voltage Input
6	CX	Analogue I/O	Sense Antenna

3.1.2 Schematic

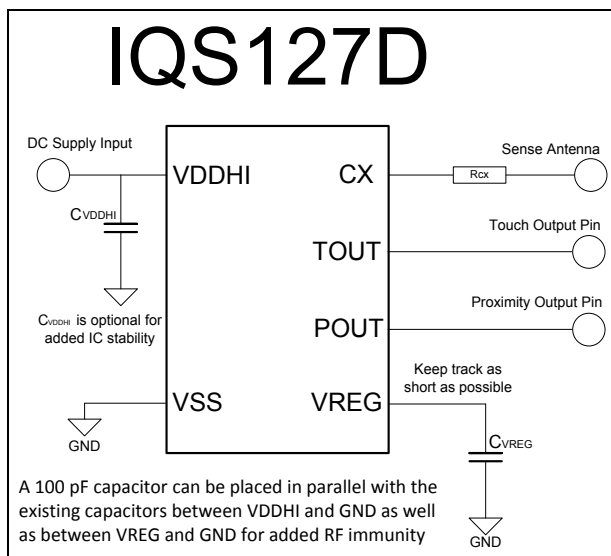

Figure 3.2 Typical application schematic of IQS127D.

3.1.3 Typical values

Component	Value
C_{VREG}	1uF
R_{CX}	470 Ω (typical)
C_{VDDHI}	1uF



4 User Configurable Options

The IQS127D provides One Time Programmable (OTP) user options (each option can be modified only once). The device is fully functional in the default (unconfigured) state. OTP options are intended for specific applications.

The configuration of the device can be done on packaged devices or in-circuit. In-circuit configuration may be limited by values of external components chosen.

A number of standard device configurations are available (refer to Table 10.1). Azoteq can supply pre-configured devices for large quantities.

4.1 Configuring of Devices

Azoteq offers a Configuration Tool (CTxxx) and accompanying software (USBProg.exe) that can be used to program the OTP user options for prototyping purposes. More details regarding the configuration of the device with the USBProg program is explained by application note: “AZD007 – USBProg Overview” which can be found on the Azoteq website.

Alternate programming solutions of the IQS127D also exist. For further enquiries regarding this matter please contact Azoteq at ProxSenseSupport@azoteq.com or the local distributor.

Table 4-1: User Selectable Configuration Options: Bank 0

T _{THR1}	T _{THR0}	P _{THR1}	P _{THR0}	FUNC1	FUNC0	LOGIC	~
							bit 0
							bit 7
Bank 1: bit 0, Bank 0: bit 7-6	T_{THR<2:0>} : Touch Thresholds						-Section 6.4
	000 = 1/16						
	001 = 1/32						
	010 = 2/16						
	011 = 3/16						
	100 = 4/16						
	101 = 6/16						
	110 = 8/16						
	111 = 10/16						
Bank0: bit 5-4	P_{THR<1:0>} : Proximity Thresholds						-Section 6.3
	00 = 2						
	01 = 4						
	10 = 8						
	11 = 16						
Bank0: bit 3-2	FUNC<1:0> : OUTPUT Pins' functions						-Section 6.2
	00 = POUT active, TOUT active						
	01 = POUT latch, TOUT active						
	10 = POUT active, TOUT toggle						
	11 = POUT latch, TOUT toggle						
Bank0: bit 1	LOGIC : Output logic select -						-Section 6.1
	0 = Active Low						
	1 = Active High						
Bank0: bit 0	Not Used						



Table 4-2: User Selectable Configuration Options: Bank 1

STREAMING	-	SHORT STREAMING	t _{HALT1}	t _{HALT0}	P _{MODE1}	P _{MODE0}	T _{THR2}
-----------	---	-----------------	--------------------	--------------------	--------------------	--------------------	-------------------

bit 7

bit 0

Bank 1: bit 7 **STREAMING:** 1-wire streaming mode -Section 7
 0 = disabled
 1 = enabled

Bank1: bit 6 **Not used**

Bank1: bit 5 **SHORT STREAMING:** Short word streaming enable
 (Function enabled if this bit together with STREAMING bit is set) –Section 7

Bank1: bit 4-3 **t_{HALT<1:0>}:** Halt time of Long Term Average -Section 6.6
 00 = 18.6 seconds
 01 = 74.5 seconds
 10 = Never
 11 = Always

Bank1: bit 2-1 **P_{MODE<1:0>}:**Power Modes -Section 6.5
 00 = Boost Mode
 01 = Normal Power Mode
 10 = Low Power Mode 1
 11 = Low Power Mode 2

Bank1: bit 0 **T_{THR<2:0>}:** Touch Thresholds -Section 6.4
 See Table 4-1



5 Measuring capacitance using the *Charge Transfer* method

The *charge transfer* method of capacitive sensing is employed on the IQS127D. (The charge transfer principle is thoroughly described in the application note: “AZD004 - Azoteq Capacitive Sensing”.)

A charge cycle is used to take a measurement of the capacitance of the sense antenna (connected to Cx) relative to ground. It consists of a series of pulses charging Cx and discharging Cx to the reference capacitor, at the charge transfer frequency (FCX - refer to Section 9). The count of the pulses required to reach a trip voltage on the reference capacitor is referred to as a **current sample** (CS) which is the instantaneous capacitive measurement. The CS is used to determine if either a physical contact or proximity event occurred (refer to section 6.6.1), based on the change in CS detected. The typical values of CS, without a touch or proximity condition range between 650 and 1150, although higher and lower counts can be used based on the application requirements. With CS larger than +/-1150

the gain of the system may become too high causing unsteady current samples.

The IQS127D schedules a charge cycle every t_{SAMPLE} seconds to ensure regular samples for processing of results. The duration of the charge cycle is defined as t_{CHARGE} . (refer to Figure 5.1) and varies according to the counts required to reach the trip voltage. Following the charge cycle other activities such as data streaming is completed (if in streaming mode), before the next charge cycle is initiated.

Please note: Attaching a probe to the Cx pin will increase the capacitance of the sense plate and therefore CS. This may have an immediate influence on CS (decrease t_{CHARGE} – thus CS) and cause a proximity or touch event. After t_{HALT} seconds the system will adjust to accommodate for this change. If the total load on Cx, with the probe attached is still lower than the maximum Cx load the system will continue to function normally after t_{HALT} seconds with the probe attached.

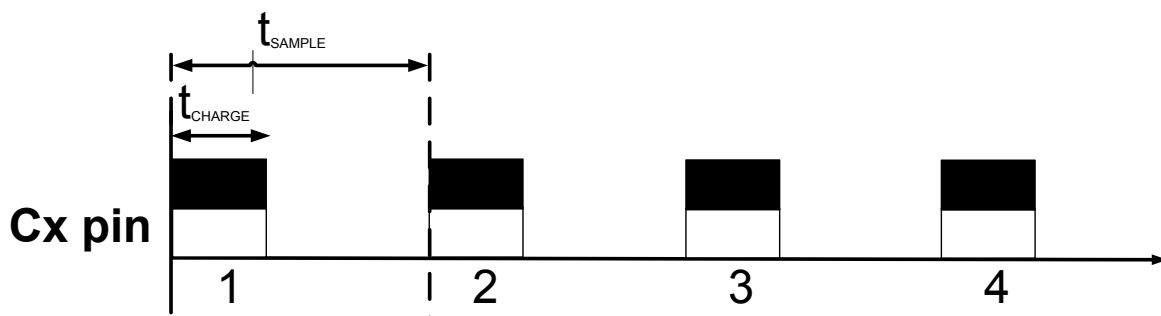

Figure 5.1 Charge cycles as can be seen on Cx.

6 Descriptions of User Options

This section describes the individual user programmable options of the IQS127D in more detail.

User programmable options are programmed to One Time Programmable (OTP) fuse registers.

Note:

- HIGH=Logical '1' and LOW=Logical '0'.
- The following sections are explained with the OUT, POUT and TOUT taken as 'Active LOW'.
- The default is always where bits are set to 0.



Refer to section 9.3 for the sourcing and sinking capabilities of OUT, POUT and TOUT. These pins are sourced from V_{DDHI} and will be turned HIGH (when active high) for a minimum time of t_{HIGH}, and LOW for a minimum time of t_{LOW} (when active low).

6.1 Logic select for output(s)

The logic used by the device can be selected as active HIGH or active LOW. The output pins POUT, TOUT and OUT will function based on the selection.

Configuration: Bank0 bit1

LOGIC: Output logic select -	
Bit	Selection
0	Active Low
1	Active High

Configuration: Bank0 bit2-3

FUNC1:FUNC0 OUTPUT Pins' functions	
<u>IQS127D</u>	
Bit	Selection
00	POUT active, TOUT active
01	POUT latch, TOUT active
10	POUT active, TOUT toggle
11	POUT latch, TOUT toggle

6.2 Output pin function

Various options for the function of the output pin(s) are available. These are selected as follow:

6.2.1 Output function: Active

With a Proximity or Touch event, the output pin will change to LOW and stay LOW for as long as the event remains (see Figure 6.1). Also refer to the use of t_{HALT} section 6.6.1 that may cause the termination of the event.

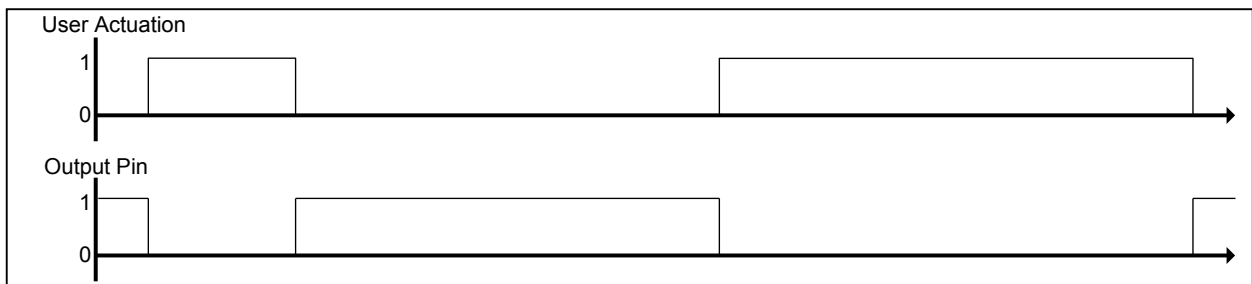

Figure 6.1 Active Mode Output Configuration

6.2.2 Output function: Latch (for t_{LATCH})

With a Proximity or Touch event, the output pin will latch LOW for t_{LATCH} seconds.

When the event remains active longer than t_{LATCH} the output pin will remain LOW as long as the event remains active (see Figure 6.2).

When the event terminates prior to t_{LATCH} the output pin will remain LOW.

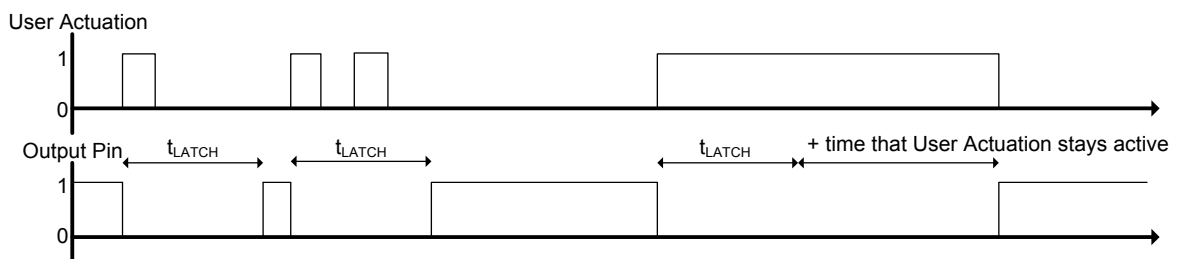

Figure 6.2 Latch Mode Output Configuration



6.2.3 Output function: Toggle

The output pin will toggle with every Proximity or Touch event occurring. Thus when an event occurs and the output is LOW the output will

become HIGH and when the output is HIGH the output will become LOW (see Figure 6.3).

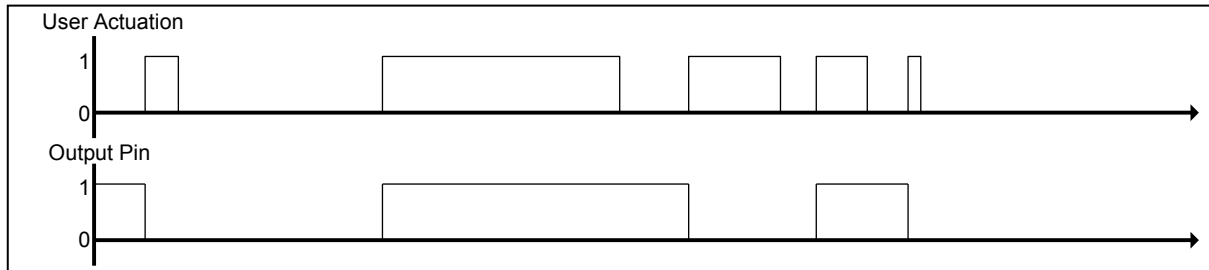

Figure 6.3 Toggle Mode Output Configuration

6.3 Proximity Threshold

The IQS127D has 4 proximity threshold settings. The proximity threshold is selected by the designer to obtain the desired sensitivity and noise immunity. The proximity event is triggered based on the selected proximity threshold; the CS and the LTA (Long Term Average). The threshold is expressed in terms of counts; the same as CS (refer to Section 5).

The touch event is triggered based on T_{TH} , CS and LTA. A touch event is identified when for at least 3 consecutive samples the following equation holds:

$$T_{TH} \leq LTA - CS$$

With lower average CS (therefore lower LTA) values the touch threshold will be lower and vice versa.

Configuration: Bank0 bit4-5

P_{THR1}:P_{THR0} Proximity Thresholds

Bit	Selection
00	2 (Most sensitive)
01	4
10	8
11	16 (Least sensitive)

Configuration: Bank0 bit6-7 and Bank1 bit0

T_{THR2}:T_{THR0} Proximity Thresholds

Bit	Selection
000	1/16
001	1/32 (Most sensitive)
010	2/16
011	3/16
100	4/16
101	6/16
110	8/16
111	10/16 (Least sensitive)

A proximity event is identified when for at least 6 consecutive samples the following equation holds:

$$P_{THR} \leq LTA - CS$$

Where LTA is the Long Term Average (refer to 6.6.1)

6.4 Touch Threshold

The IQS127D has 8 touch threshold settings. The touch threshold is selected by the designer to obtain the desired touch sensitivity. The touch threshold is expressed as a fraction of the LTA as follows:

$$T_{THR} = \text{Selected Touch Threshold} \times LTA$$

Where LTA is the Long Term Average (refer to 6.6.1)

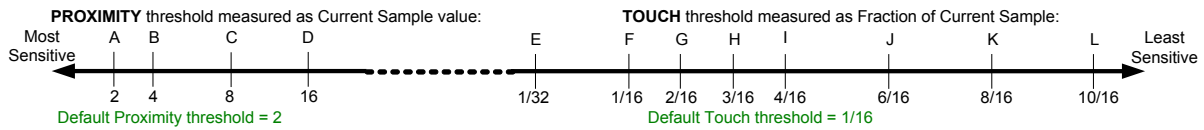

Figure 6.4 Proximity and Touch Thresholds.

6.5 Power Modes

The IQS127D IC has four power modes specifically designed to reduce current consumption for battery applications.

The power modes are basically implemented around the occurrence of charge cycle every t_{SAMPLE} seconds (refer to Section 5). The fewer charge transfer cycles that need to occur per second the lower the power consumption (but decreased response time).

During Boost Power Mode (BP), charge cycles are initiated approximately every 9ms.

Additional Power Modes are provided. While in any power mode the device will zoom to BP

whenever a current sample (CS) indicates a possible proximity or touch event. The device will remain in BP for t_{ZOOM} seconds and then return to the selected power mode. The Zoom function allows reliable detection of events with current samples being produced at the BP rate.

Table 6-1: Power Mode configuration (Bank1 bit[3:2])

Bit	Power Mode timing	t_{SAMPLE} (ms)
00	t_{BP} (default)	BP (9ms)
01	t_{NP}	50
10	t_{LP1}	100
11	t_{LP2}	200

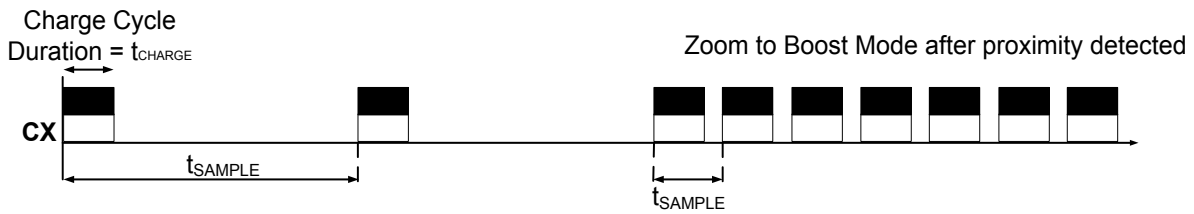

Figure 6.5 LP Modes: Charge cycles

6.6 Filters used by the IQS127D

The IQS127D device employs various signal processing functions that includes the execution of various filters as described below.

6.6.1 Long Term Average (LTA)

Capacitive touch devices detect changes in capacitance that are not always related to the intended proximity or touch of a human. This is a result of changes in the environment of the sense plate and other factors. These changes need to be compensated for in various manners in order to reliably detect touch events and especially to detect proximity events. One mechanism

the IQS127D employs is the use of a Long Term Averaging filter (IIR - Infinite Impulse Response - type filter) which tracks slow changes in the environment (expressed as changes in the current sample). The result of this filter is a Long Term Average (LTA) value that forms a dynamic reference used for various functions such as identification of proximity and touch events.

The LTA is calculated from the current samples (CS). The filter only executes while no proximity or touch event is detected to ensure compensation only for environmental changes. However there may be instances where sudden changes in the environment or changes in the environment while a proximity



or touch event has been detected cause the CS to drift away from the LTA. To compensate for these situations a Halt Timer (t_{HALT}) has been defined.

The Halt Timer is started when a proximity or touch event occurs and when it expires the LTA filter is recalibrated. Recalibration causes $LTA < CS$, thus the disappearance of proximity or touch events (refer to Section 6.3 and Section 6.4).

The designer needs to select a Halt Timer value to best accommodate the required application.

Configuration: Bank1 bit4-3

$t_{\text{HALT1}}:t_{\text{HATL0}}$: Halt time of Long Term Average	
Bit	Selection
00	18.6 seconds
01	74.5 seconds
10	NEVER
11	ALWAYS

Notes:

- The “NEVER” option indicates that the execution of the filters will never be halted.
- With the ‘ALWAYS’ option and the detection of a proximity event the execution of the filter will be halted for only 18.6 seconds and with the detection of a touch event the execution of the filter will be halted as long as the touch condition applies.

Refer to Application note “AZD024 - Graphical Representation of the IIR Filter” for detail regarding the execution of the LTA filter.

6.6.2 IIR Raw Data filter

The extreme sensitivity of the IQS127D makes it susceptible to external noise sources. This causes a decreased signal to noise (S/N) ratio, which could potentially cause false event detections.

Noise can also couple into the device as a result of poor PCB, sense antenna design and other factors influencing capacitive sensing devices.

In order to compensate for noise the IQS127D uses an IIR filter on the raw data to minimize result of noise in the current sample. This filter cannot be disabled.

7 1-Wire Data Streaming Mode

The IQS127D has the capability to stream data to a MCU. This provides the designer with the capability to obtain the parameters within the device in order to aid design into applications. Data streaming may further be used by a MCU to control events or further process results obtained from the IQS127D devices. Data streaming is performed as a 1-wire data protocol on one of the output pins (TOUT). The function of this pin is therefore lost when the device is put in streaming mode. Data Streaming can be enabled as indicated below:

Configuration: Bank1 bit7

STREAMING: 1-wire data streaming mode	
Bit	Selection
0	Disabled
1	Enabled

The IQS127D has a short data streaming mode where a reduced set of data is streamed to the MCU. This option can be used only when data streaming has been activated.

Configuration: Bank1 bit5

SHORT STREAMING: Short data streaming	
Bit	Selection
0	Disabled
1	Enabled

Data streaming is initiated by the IQS127D. When data streaming is enabled data is sent following each charge cycle (refer to Section 5).

Figure 7.1 illustrates the communication protocol for initialising and sending data with the 1 wire communication protocol.

1. Communication is initiated by a START bit. Bit defined as a low condition for t_{START} .



- Following the START bit, is a synchronisation byte ($T_{INIT} = 0xAA$). This byte is used by the MCU for clock synchronisation.
- Following T_{INIT} the data bytes will be sent. With short data streaming mode enabled, 5 bytes of data will be sent,

otherwise 8 bytes will be sent after each charge cycle.

- Each byte sent will be preceded by a START bit and a STOP bit will follow every byte.
- STOP bit indicated by taking pin 1 high. The STOP bit does not have a defined period.

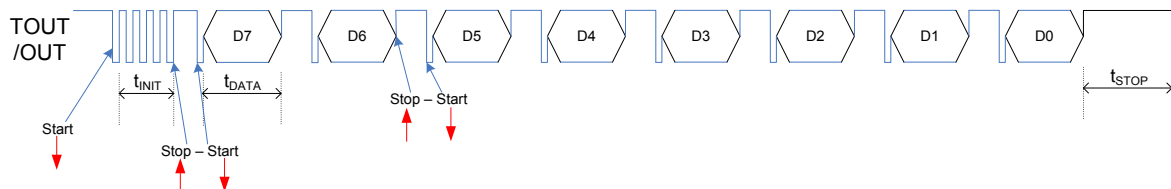

Figure 7.1 1-wire data streaming mode

The following tables define the data streamed from the IQS127D devices during Short Data Streaming and Normal Data Streaming modes.

Table 7.1 Byte Definitions for Short Data Streaming Mode

Byte	Bit	Value
0	7:0	Current sample High byte
1	15:8	Current sample Low byte
2	23:16	LTA High byte
3	31:24	LTA Low byte
4	39	Proximity event detected
	38	Touch event detected
4	35:32	Not used (always 0)
		Zoom active
		Non-user data

Table 7.2 Byte Definitions for Normal Data Streaming Mode

Byte	Bit	Value
0	7:0	CS High byte
1	15:8	CS Low byte
2	23:16	LTA High byte
3	31:24	LTA Low byte
4	39	ATI busy
	38	Compensation (P5)
	37	P_{TH0} – Proximity threshold
	36	P_{TH1} – Proximity threshold
	35	Not used (always 0)
	34	Zoom active
	33	Touch event detected
	32	Proximity event detected
5	47	ATI Multiplier (I)
	46	ATI Multiplier (S)
	45	ATI Multiplier (S)
	44	Compensation (P4)
	43	Compensation (P3)
	42	Compensation (P2)
	41	Compensation (P1)
	40	Compensation (P0)
6	55:48	Non-user data
7	63:56	Counter

Azoteq provides an application tool (GUI) that can be utilised to capture and visualise the data streamed from the IQS127D. Refer to the Azoteq website for more details.

Normal 1-wire data streaming mode is used when all data is required from IC. Short 1-



wire data streaming mode is used when only instantaneous measurement and Prox/Touch events are needed.

Sample code available: “AZD017 - IQS127D 1-Wire Protocol SAMPLE CODE”

8 Antenna Tuning Implementation (ATI)

ATI is a sophisticated technology implemented in the latest generation ProxSense® devices that optimises the performance of the sensor in a wide range of applications and environmental conditions (refer to application note AZD0027 - Antenna Tuning Implementation).

ATI makes adjustments through external reference capacitors (as required by most other solutions) to obtain optimum performance.

ATI adjusts internal circuitry according to two parameters, the ATI multiplier and the ATI compensation. The ATI multiplier can be viewed as a course adjustment and the ATI compensation as a fine adjustment.

The adjustment of the ATI parameters will result in variations in the current sample and sensitivity. Sensitivity can be observed as the change in current sample as the result of a fixed change in sensed capacitance. The ATI parameters have been chosen to provide significant overlap. It may therefore be possible to select various combinations of ATI multiplier and ATI compensation settings to obtain the same current sample. The sensitivity of the various options may however be different for the same current sample.

8.1 Automatic ATI

The IQS127D implements an automatic ATI algorithm. This algorithm automatically adjusts the ATI parameters to optimise the sensing antenna’s connection to the device.

The device will execute the ATI algorithm whenever the device starts-up and when the

current samples are not within a predetermined range.

While the automatic ATI algorithm is in progress this condition will be indicated in the streaming data, and proximity and touch events cannot be detected. The device will only briefly remain in this condition and it will be entered only when relatively large shifts in the current sample has been detected.

The automatic ATI function aims to maintain a constant current sample, regardless of the capacitance of the sense antenna (within the maximum range of the device).

The effects of auto-ATI on the application are the following:

- Automatic adjustment of the device configuration and processing parameters for a wide range of PCB and application designs to maintain an optimal configuration for proximity and touch detection.
- Automatic tuning of the sense antenna at start-up to optimise the sensitivity of the application.
- Automatic re-tuning when the device detects changes in the sensing antenna’s capacitance to accommodate a large range of changes in the environment of the application that influences the sensing antenna.
- Re-tuning only occurs during device operation when a relatively large sensitivity reduction is detected. This is to ensure smooth operation of the device during operation.
- Re-tuning may temporarily influence the normal functioning of the device, but in most instances the effect will be hardly noticeable.
- Shortly after the completion of the re-tuning process the sensitivity of a proximity detection may be reduced slightly for a few seconds as internal filters stabilise.

Automatic ATI can be implemented effectively due to:

- Excellent system signal to noise ratio (SNR).



- Effective digital signal processing to remove AC and other noise.
- The very stable core of the devices.
- The built in capability to accommodate a large range of sensing antenna capacitances.

8.2 Noise Immunity

The IQS127D has advanced immunity to RF noise sources such as GSM cellular telephones, DECT, Bluetooth and WIFI devices. Design guidelines should however be followed to ensure the best noise immunity. The design of capacitive sensing applications can encompass a large range of situations but as a summary the following should be noted to improve a design:

- A ground plane should be placed under the IC, except under the Cx line.
- All the tracks on the PCB must be kept as short as possible.
- The capacitor between V_{DDHI} and V_{SS} as well as between V_{REG} and V_{SS} , must be placed as close as possible to the IC.
- A 100 pF capacitor can be placed in parallel with the 1uF capacitor between V_{DDHI} and V_{SS} . Another 100 pF capacitor can be placed in parallel with the 1uF capacitor between V_{REG} and V_{SS} .
- When the device is too sensitive for a specific application a parasitic capacitor (max 5pF) can be added between the Cx line and ground.
- Proper sense antenna and button design principles must be followed.
- Unintentional coupling of sense antenna to ground and other circuitry must be limited by increasing the distance to these sources or making use of the driven shield.
- In some instances a ground plane some distance from the device and sense antenna may provide significant shielding from undesired interference.
- When the capacitance between the sense antenna and ground becomes too large the sensitivity of the device may be influenced.



9 Electrical Specifications

9.1 Absolute Maximum Specifications

Exceeding these maximum specifications may cause damage to the device.

Operating temperature	-40°C to 85°C
Supply Voltage ($V_{DDHI} - V_{SS}$)	5.5V
Maximum pin voltage (OUT, T _{OUT} , P _{OUT})	$V_{DDHI} + 0.5V$
Pin voltage (Cx)	2.5V
Minimum pin voltage (VDDHI, VREG, OUT, T _{OUT} , P _{OUT} , Cx)	$V_{SS} - 0.5V$
Minimum power-on slope	100V/s
HBM ESD protection ¹ (VDDHI, VREG, V _{SS} , T _{OUT} /OUT, P _{OUT} /SHLD, Cx)	2kV

9.2 General Characteristics (Measured at 25°C)

Table 9.1 IQS127D General Operating Conditions

DESCRIPTION	Conditions	PARAMETER	MIN	TYP	MAX	UNIT
Supply voltage		V_{DDHI}	2.95		5.50	V
Internal regulator output	$2.95 \leq V_{DDHI} \leq 5.0$	V_{REG}	2.35	2.50	2.65	V
Boost operating current	$2.95 \leq V_{DDHI} \leq 5.0$	$I_{IQS127D_BP}$		60	77	μA
Normal operating current	$2.95 \leq V_{DDHI} \leq 5.0$	$I_{IQS127D_NP}$		23	29	μA
Low power operating current	$2.95 \leq V_{DDHI} \leq 5.0$	$I_{IQS127D_LP1}$		17	22	μA
Low power operating current	$2.95 \leq V_{DDHI} \leq 5.0$	$I_{IQS127D_LP2}$		13	17	μA

Table 9.2 Start-up and shut-down slope Characteristics

DESCRIPTION	Conditions	PARAMETER	MIN	MAX	UNIT
POR	V_{DDHI} Slope $\geq 100V/s$	POR	1.45	1.70	V
BOD		BOD	1.30	1.40	V

¹ See Section 9.4.1 for further details



9.3 Output Characteristics (Measured at 25°C)

Table 9.3 TOUT Characteristics

Symbol	Description	I _{SOURCE} (mA)	Conditions	MIN	TYP	MAX	UNIT
V _{OH}	Output High voltage	1	V _{DDHI} = 5V		4.5		V
		1	V _{DDHI} = 3.3V		2.97		
		1	V _{DDHI} = 2.5V		2.25		
Symbol	Description	I _{SINK} (mA)	Conditions	MIN	TYP	MAX	UNIT
V _{OL}	Output Low voltage	1	V _{DDHI} = 5V	0.30	0.50		V
		1	V _{DDHI} = 3.3V	0.20	0.33		
		1	V _{DDHI} = 2.5V	0.20	0.25		

Table 9.4 POUT Characteristics

Symbol	Description	I _{SOURCE} (mA)	Conditions	MIN	TYP	MAX	UNIT
V _{OH}	Output High voltage	5.0	V _{DDHI} = 5V		4.5		V
		2.5	V _{DDHI} = 3.3V		2.97		
		2.5	V _{DDHI} = 2.5V		2.25		
Symbol	Description	I _{SINK} (mA)	Conditions	MIN	TYP	MAX	UNIT
V _{OL}	Output Low voltage	3.0	V _{DDHI} = 5V	0.1	0.5		V
		2.5	V _{DDHI} = 3.3V	0.1	0.33		
		2.5	V _{DDHI} = 2.5V	0.1	0.25		



9.4 Electromagnetic Compatibility

9.4.1 Electrostatic discharge (ESD)

Table 9.5 ESD Characteristics

Symbol	Ratings	Conditions	Level/Class	Maximum Value	UNIT
$V_{ESD(HBM)}$	Electrostatic discharge voltage (Human body model)	$T_A = +25^{\circ}C$, conforming to JESD22-A114	2	2000	V
$V_{ESD(CDM)}$	Electrostatic discharge voltage (Charge device model)	$T_A = +25^{\circ}C$, conforming to JESD22-C101-D	IV	1000	V
$V_{ESD(Product)}$	Electrostatic discharge voltage (Product specification) ¹	$T_A = +25^{\circ}C$, conforming to IEC61000-4-2, Air-discharge on all pins	4	±8	kV
$V_{ESD(Product)}$	Electrostatic discharge voltage (Product specification) ¹	$T_A = +25^{\circ}C$, conforming to IEC61000-4-2, Contact-discharge on all pins	3	±6	kV

9.4.2 Static Latch-Up (LU)

Table 9.6 Static Latch-Up (LU)

Class	Symbol	Parameter	Conditions
A	LU	Static latch-up class	$T_A = +25^{\circ}C$, conforming to EIA/JESD 78 IC latch-up standard

For further details on test results please request from Azoteq.

¹ Product specification is dependent on PCB layout. Test performed on standard AZP112A05 product PCB plugged into the AZP113A03 touchpad PCB, powered with a single 3.0V coin-cell.



9.5 Timing Characteristics

Table 9.7 Main Oscillator NP mode¹

SYMBOL	DESCRIPTION	Conditions	MIN	TYP	MAX	UNIT
F _{OSC}	IQS127D Main oscillator	$2.95 \leq V_{DDHI} \leq 5.0$	0.9	1	1.1	MHz

Table 9.8 General Timing Characteristics for $2.95V \leq V_{DDHI} \leq 5.0V$

SYMBOL	DESCRIPTION	Conditions	MIN	TYP	MAX	UNIT
t _{HIGH}	Output high minimum time		9			ms
t _{LOW}	Output low minimum time		9			ms
F _{CX}	Charge transfer frequency			125		kHz
t _{LATCH}	OUT high time in latch mode (active high)			4.6		sec
t _{CHARGE}	Charge cycle duration	CS = 900		7.2		ms
t _{SAMPLE}	Refer to section 5					ms
t _{BP}	Sampling period in BP	$t_{CHARGE} - 2 \leq t_{SAMPLE}$		9		ms
t _{BP}	Sampling period in BP	$t_{CHARGE} \geq t_{SAMPLE}$		t _{CHARGE} +2		ms
t _{START}	Refer to section 7		14.4	17	18.8	us
t _{INIT}	Refer to section 7			136		us
t _{DATA}	Refer to section 7			136		us
t _{NP}	Sampling period in NP			50		ms
t _{LP1}	Sampling period in LP1			100		ms
t _{LP2}	Sampling period in LP2			200		ms
t _{ZOOM}	Period in BP after possible event			4.6		s

¹ All timings are derived from the main oscillator.



Table 9.9 IQS127D Response Times

Power Mode	Proximity			IC Batch #
	Min	Max	Unit	
Boost Power	54	63	ms	All
Normal Power	95	145	ms	All
Low Power 1	145	245	ms	All
Low Power 2	245	445	ms	All
Power Mode	Touch			IC Batch #
	Typical		Unit	
All	250		ms	Up to 127DBD
All	120		ms	From 127DBx

9.6 Packaging Information

9.6.1 TSOT23-6

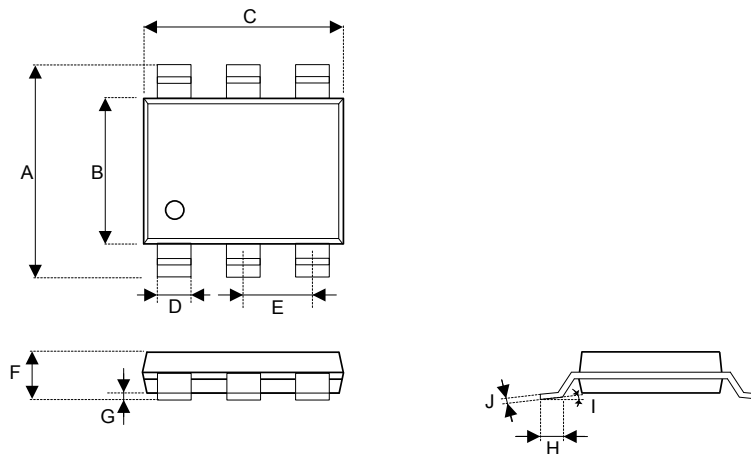

Figure 9.1 TSOT23-6 Packaging¹

Table 9.10 TSOT23-6 Dimensions

Dimension	Typical	Tolerance
A	2.80 mm	Basic
B	1.60 mm	Basic
C	2.90 mm	Basic
D	0.40 mm	±0.10mm
E	0.95 mm	Basic
F	1.00mm	Max
G	0.05 mm	±0.05mm
H	0.40 mm	±0.10mm
I	4	±4°
J	0.127 mm	+0.07/-0.007

¹ Drawing not on Scale

9.6.2 TSOT23-6 Tape

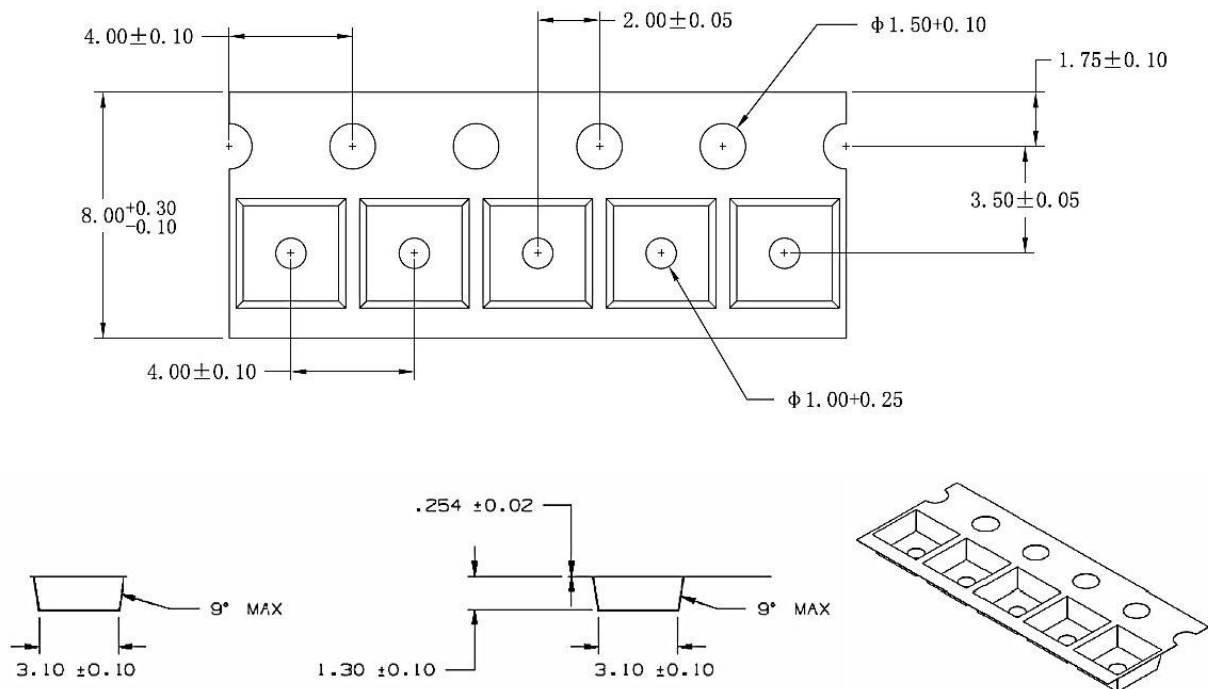

Figure 9.2 IQS127D Tape Specification

9.7 Package MSL

Moisture Sensitivity Level (MSL) relates to the packaging and handling precautions for some semiconductors. The MSL is an electronic standard for the time period in which a moisture sensitive device can be exposed to ambient room conditions (approximately 30°C/60%RH).

Increasingly, semiconductors have been manufactured in smaller sizes. Components such as thin fine-pitch devices and ball grid arrays could be damaged during SMT reflow when moisture trapped inside the component expands.

The expansion of trapped moisture can result in internal separation (delamination) of the plastic from the die or lead-frame, wire bond damage, die damage, and internal cracks. Most of this damage is not visible on the component surface. In extreme cases, cracks will extend to the component surface. In the most severe cases, the component will bulge and pop.

Table 9-1: MSL

Package	Level (duration)
TSOT23-6	MSL 1 (Unlimited at $\leq 30^\circ\text{C}/85\% \text{RH}$)



10 Datasheet and Part-number Information

10.1 Ordering Information

Only full reels can be ordered and orders will be subject to a MOQ (Minimum Order Quantity) of a full reel. Contact the official distributor for sample quantities. A list of the distributors can be found under the “Distributors” section of www.azoteq.com.

For large orders, Azoteq can provide pre-configured devices.

The Part-number can be generated by using USBProg.exe or the Interactive Part Number generator on the website.

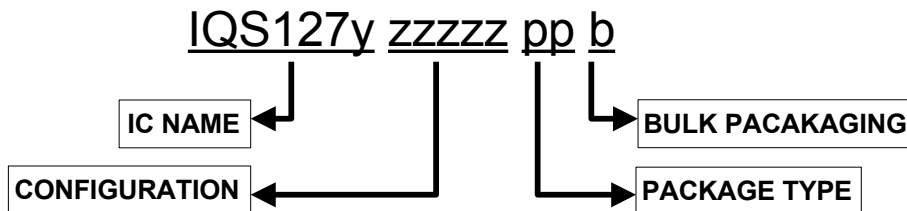

IC NAME	IQS127D	=	IQS127 with D ual outputs
CONFIGURATION	zzzzz	=	IC Configuration (hexadecimal)
PACKAGE TYPE	TS	=	TSOT23-6
BULK PACKAGING	R	=	Reel (3000pcs/reel) – MOQ = 3000pcs

10.2 Standard Devices

The default (unconfigured) device will be suitable for most applications. Some popular configurations are kept in stock and do not require further programming. (Ordering codes given for Device IDs: 03 0D / 03 0E or later (the Device ID will be read in USBProg))

Standard Devices ¹	Function
IQS127D-00000TSR	Default
IQS127D-00002TSR	Active HIGH outputs
IQS127D-00200TSR	Normal Power Mode
IQS127D-00008TSR	Touch Output ac Toggle

¹ All configurations ‘default’ except those mentioned under Function



Table 10.1 Standard Devices Available

10.3 Device Packaging Convention

10.3.1 Top

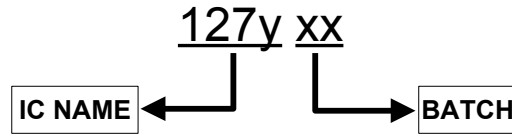

IC Name	127D
BATCH	XX

10.3.2 Bottom

Some batches IQS127D will not have any bottom markings. These devices are configured after marking, and may have variations in configuration – please refer to the reel label.

Other batches will display the configuration set on the chip on the bottom marking.

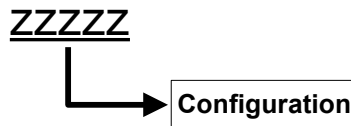



10.4 Datasheet Revision History

- Version 1.0 First official release
- Version 1.1 Add BOD and POR
 - Correct formatting errors
 - Correct minor errors
- Version 1.2 Edited version (Final Production release)
- Version 1.3 Updated current consumption
- Version 1.4 Corrected version number
 - Fixed Section 10.3
- Version 1.4 Fixed bookmarks and added patents on last page
- Version 1.6 Updated power mode descriptions and Section 4
 - Removed EMI test results
- Version 1.7 Updated Short and Long 1-Wire protocol data string (removed LTN)
 - Removed the word 'debug' when describing the 1-wire data mode
 - Added MSL data
- Version 1.8 Corrected Section 4.1
- Version 1.9 Updated Package dimensions
 - Updated ESD testing information
- Version 1.10 Fix broken references
- Version 1.11 Fixed Package Dimensions
 - Added Tape Specification
- Version 1.12 Update package marking
 - Update Contact Information
- Version 1.13 Remove IQS127S (IQS127S is EOL)
 - Low voltage version no longer available – use IQS227AS instead.
- Version 1.14 Update Contact and Patent Information



11 Contact Information

	USA	Asia	South Africa
Physical Address	6507 Jester Blvd Bldg 5, suite 510G Austin TX 78750 USA	Rm2125, Glittery City Shennan Rd Futian District Shenzhen, 518033 China	109 Main Street Paarl 7646 South Africa
Postal Address	6507 Jester Blvd Bldg 5, suite 510G Austin TX 78750 USA	Rm2125, Glittery City Shennan Rd Futian District Shenzhen, 518033 China	PO Box 3534 Paarl 7620 South Africa
Tel	+1 512 538 1995	+86 755 8303 5294 ext 808	+27 21 863 0033
Fax	+1 512 672 8442		+27 21 863 1512
Email	kobusm@azoteq.com	linayu@azoteq.com.cn	info@azoteq.com

Please visit www.azoteq.com for a list of distributors and worldwide representation.

The following patents relate to the device or usage of the device: US 6,249,089 B1; US 6,621,225 B2; US 6,650,066 B2; US 6,952,084 B2; US 6,984,900 B1; US 7,084,526 B2; US 7,084,531 B2; US 7,265,494 B2; US 7,291,940 B2; US 7,329,970 B2; US 7,336,037 B2; US 7,443,101 B2; US 7,466,040 B2 ; US 7,498,749 B2; US 7,528,508 B2; US 7,755,219 B2; US 7,772,781 B2; US 7,781,980 B2; US 7,915,765 B2; US 7,994,726 B2; US 8,035,623 B2; US RE43,606 E; US 8,288,952 B2; US 8,395,395 B2; US 8,531,120 B2; US 8,659,306 B2; US 8,823,273 B2 B2; EP 1 120 018 B2; EP 1 206 168 B1; EP 1 308 913 B1; EP 1 530 178 A1; EP 2 351 220 B1; EP 2 559 164 B1; CN 1330853; CN 1783573; AUS 761094; HK 104 1401

IQ Switch®, SwipeSwitch™, ProxSense®, LightSense™, AirButton™ and the  logo are trademarks of Azoteq.

The information in this Datasheet is believed to be accurate at the time of publication. Azoteq uses reasonable effort to maintain the information up-to-date and accurate, but does not warrant the accuracy, completeness or reliability of the information contained herein. All content and information are provided on an "as is" basis only, without any representations or warranties, express or implied, of any kind, including representations about the suitability of these products or information for any purpose. Azoteq disclaims all warranties and conditions with regard to these products and information, including but not limited to all implied warranties and conditions of merchantability, fitness for a particular purpose, title and non-infringement of any third party intellectual property rights. Azoteq assumes no liability for any damages or injury arising from any use of the information or the product or caused by, without limitation, failure of performance, error, omission, interruption, defect, delay in operation or transmission, even if Azoteq has been advised of the possibility of such damages. The applications mentioned herein are used solely for the purpose of illustration and Azoteq makes no warranty or representation that such applications will be suitable without further modification, nor recommends the use of its products for application that may present a risk to human life due to malfunction or otherwise. Azoteq products are not authorized for use as critical components in life support devices or systems. No licenses to patents are granted, implicitly, express or implied, by estoppel or otherwise, under any intellectual property rights. In the event that any of the abovementioned limitations or exclusions does not apply, it is agreed that Azoteq's total liability for all losses, damages and causes of action (in contract, tort (including without limitation, negligence) or otherwise) will not exceed the amount already paid by the customer for the products. Azoteq reserves the right to alter its products, to make corrections, deletions, modifications, enhancements, improvements and other changes to the content and information, its products, programs and services at any time or to move or discontinue any contents, products, programs or services without prior notification. For the most up-to-date information and binding Terms and Conditions please refer to www.azoteq.com.

WWW.AZOTEQ.COM

info@azoteq.com