



Chipsmall Limited consists of a professional team with an average of over 10 year of expertise in the distribution of electronic components. Based in Hongkong, we have already established firm and mutual-benefit business relationships with customers from,Europe,America and south Asia,supplying obsolete and hard-to-find components to meet their specific needs.

With the principle of "Quality Parts,Customers Priority,Honest Operation,and Considerate Service",our business mainly focus on the distribution of electronic components. Line cards we deal with include Microchip,ALPS,ROHM,Xilinx,Pulse,ON,Everlight and Freescale. Main products comprise IC,Modules,Potentiometer,IC Socket,Relay,Connector.Our parts cover such applications as commercial,industrial, and automotives areas.

We are looking forward to setting up business relationship with you and hope to provide you with the best service and solution. Let us make a better world for our industry!



Contact us

Tel: +86-755-8981 8866 Fax: +86-755-8427 6832

Email & Skype: info@chipsmall.com Web: www.chipsmall.com

Address: A1208, Overseas Decoration Building, #122 Zhenhua RD., Futian, Shenzhen, China



CURRENT LIMITING SINGLE CHANNEL DRIVER

Features

- Floating channel designed for bootstrap operation Fully operational to +500V Tolerant to negative transient voltage dV/dt immune
- Gate drive supply range from 12 to 18V
- Undervoltage lockout
- Current detection and limiting loop to limit driven power transistor current
- Error lead indicates fault conditions and programs shutdown time
- Output in phase with input
- 2.5V, 5V and 15V input logic compatible
- Also available LEAD-Free

Description

The IR2125(S) is a high voltage, high speed power MOSFET and IGBT driver with over-current limiting protection circuitry. Proprietary HVIC and latch immune CMOS technologies enable ruggedized monolithic construction. Logic inputs are compatible with standard CMOS or LSTTL outputs, down to 2.5V logic. The output driver features a high pulse current buffer stage designed for minimum driver cross-conduction. The protection circuitry detects over-current in the driven power transistor and limits the gate drive voltage. Cycle by cycle shutdown is programmed by an external capacitor which directly controls the time interval between detection of the over-current limiting conditions and latched shutdown. The floating channel can be used to drive an N-channel power MOSFET or IGBT in the high or low side configuration which operates up to 500 volts.

Product Summary

V_{OFFSET}	500V max.
I_{O+/-}	1A / 2A
V_{OUT}	12 - 18V
V_{Csth}	230 mV
ton/off (typ.)	150 & 150 ns

Packages

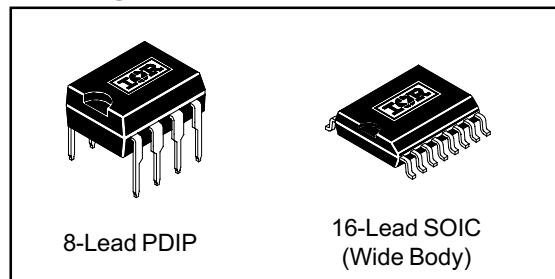

Typical Connection

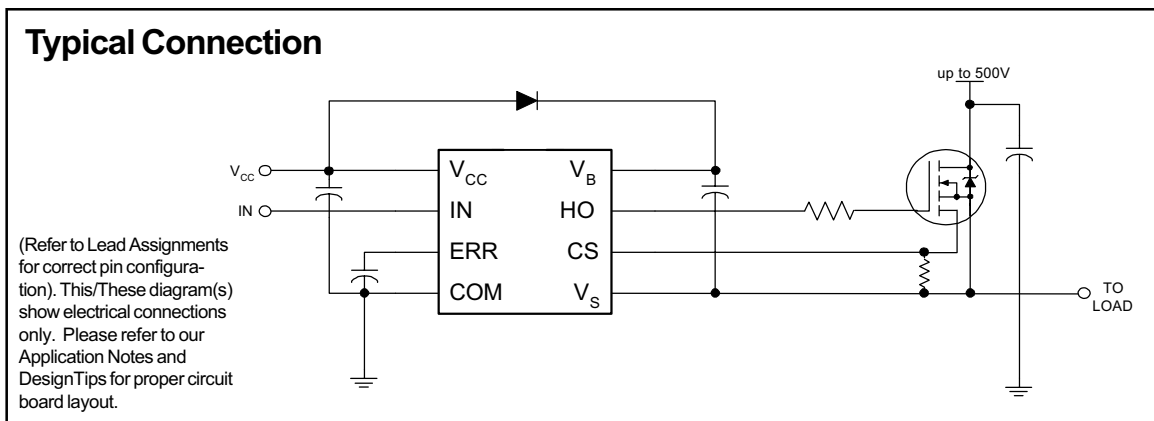

IR2125(S) & (PbF)

Absolute Maximum Ratings

Absolute Maximum Ratings indicate sustained limits beyond which damage to the device may occur. All voltage parameters are absolute voltages referenced to COM. The Thermal Resistance and Power Dissipation ratings are measured under board mounted and still air conditions.

Symbol	Definition	Min.	Max.	Units
V _B	High Side Floating Supply Voltage	-0.3	525	V
V _S	High Side Floating Offset Voltage	V _B - 25	V _B + 0.3	
V _{HO}	High Side Floating Output Voltage	V _S - 0.3	V _B + 0.3	
V _{CC}	Logic Supply Voltage	-0.3	25	
V _{IN}	Logic Input Voltage	-0.3	V _{CC} + 0.3	
V _{ERR}	Error Signal Voltage	-0.3	V _{CC} + 0.3	
V _{CS}	Current Sense Voltage	V _S - 0.3	V _B + 0.3	
dV _S /dt	Allowable Offset Supply Voltage Transient	—	50	V/ns
P _D	Package Power Dissipation @ T _A ≤ +25°C (8 lead PDIP)	—	1.0	W
	(16 lead SOIC)	—	1.25	
R _{thJA}	Thermal Resistance, Junction to Ambient (8 lead PDIP)	—	125	°C/W
	(16Lead SOIC)	—	100	
T _J	Junction Temperature	—	150	°C
T _S	Storage Temperature	-55	150	
T _L	Lead Temperature (Soldering, 10 seconds)	—	300	

Recommended Operating Conditions

The Input/Output logic timing diagram is shown in Figure 1. For proper operation the device should be used within the recommended conditions. The V_S offset rating is tested with all supplies biased at 15V differential.

Symbol	Definition	Min.	Max.	Units
V _B	High Side Floating Supply Voltage	V _S + 12	V _S + 18	V
V _S	High Side Floating Offset Voltage	Note 1	500	
V _{HO}	High Side Floating Output Voltage	V _S	V _B	
V _{CC}	Logic Supply Voltage	0	18	
V _{IN}	Logic Input Voltage	0	V _{CC}	
V _{ERR}	Error Signal Voltage	0	V _{CC}	
V _{CS}	Current Sense Signal Voltage	V _S	V _B	
T _A	Ambient Temperature	-40	125	°C

Note 1: Logic operational for V_S of -5 to +500V. Logic state held for V_S of -5V to -V_{BS}. (Please refer to the Design Tip DT97-3 for more details).

Dynamic Electrical Characteristics

$V_{BIAS} (V_{CC}, V_{BS}) = 15V$, $C_L = 3300$ pF and $T_A = 25^\circ C$ unless otherwise specified. The dynamic electrical characteristics are measured using the test circuit shown in Figures 3 through 6.

Symbol	Definition	Figure	Min.	Typ.	Max.	Units	Test Conditions
t_{on}	Turn-On Propagation Delay	7	—	170	240	ns	$V_{IN} = 0$ & $5V$ $V_S = 0$ to $600V$
t_{off}	Turn-Off Propagation Delay	8	—	200	270		
t_{sd}	ERR Shutdown Propagation Delay	9	—	1.7	2.2	μs	
t_r	Turn-On Rise Time	10	—	43	60	ns	
t_f	Turn-Off Fall Time	11	—	26	35		
t_{cs}	CS Shutdown Propagation Delay	12	—	0.7	1.2	μs	$C_{ERR} = 270$ pF
t_{err}	CS to ERR Pull-Up Propagation Delay	13	—	9.0	12		

Static Electrical Characteristics

$V_{BIAS} (V_{CC}, V_{BS}) = 15V$ and $T_A = 25^\circ C$ unless otherwise specified. The V_{IN} , V_{TH} and I_{IN} parameters are referenced to COM. The V_O and I_O parameters are referenced to V_S .

Symbol	Definition	Figure	Min.	Typ.	Max.	Units	Test Conditions	
V_{IH}	Logic "1" Input Voltage	14	2.2	—	—	V		
V_{IL}	Logic "0" Input Voltage	15	—	—	0.8			
V_{CSTH+}	CS Input Positive Going Threshold	16	150	230	320	mV		
V_{CSTH-}	CS Input Negative Going Threshold	17	130	210	300			
V_{OH}	High Level Output Voltage, $V_{BIAS} - V_O$	18	—	—	100		$I_O = 0A$	
V_{OL}	Low Level Output Voltage, V_O	19	—	—	100		$I_O = 0A$	
I_{LK}	Offset Supply Leakage Current	20	—	—	50	μA	$V_B = V_S = 500V$	
I_{QBS}	Quiescent V_{BS} Supply Current	21	—	400	1000		$V_{IN} = V_{CS} = 0V$ or $5V$	
I_{QCC}	Quiescent V_{CC} Supply Current	22	—	700	1200		$V_{IN} = V_{CS} = 0V$ or $5V$	
I_{IN+}	Logic "1" Input Bias Current	23	—	4.5	10		$V_{IN} = 5V$	
I_{IN-}	Logic "0" Input Bias Current	24	—	—	1.0		$V_{IN} = 0V$	
I_{CS+}	"High" CS Bias Current	25	—	4.5	10		$V_{CS} = 3V$	
I_{CS-}	"Low" CS Bias Current	26	—	—	1.0		$V_{CS} = 0V$	
V_{BSUV+}	V_{BS} Supply Undervoltage Positive Going Threshold	27	8.5	9.2	10.0		V	
V_{BSUV-}	V_{BS} Supply Undervoltage Negative Going Threshold	28	7.7	8.3	9.0			
V_{CCUV+}	V_{CC} Supply Undervoltage Positive Going Threshold	29	8.3	8.9	9.6			
V_{CCUV-}	V_{CC} Supply Undervoltage Negative Going Threshold	30	7.3	8.0	8.7			
I_{ERR}	ERR Timing Charge Current	31	65	100	130	μA	$V_{IN} = 5V$, $V_{CS} = 3V$ $ERR < V_{ERR+}$	
I_{ERR+}	ERR Pull-Up Current	32	8.0	15	—	mA	$V_{IN} = 5V$, $V_{CS} = 3V$ $ERR > V_{ERR+}$	
I_{ERR-}	ERR Pull-Down Current	33	16	30	—		$V_{IN} = 0V$	
I_{O+}	Output High Short Circuit Pulsed Current	34	1.0	1.6	—	A	$V_O = 0V$, $V_{IN} = 5V$ $PW \leq 10 \mu s$	
I_{O-}	Output Low Short Circuit Pulsed Current	35	2.0	3.3	—		$V_O = 15V$, $V_{IN} = 0V$ $PW \leq 10 \mu s$	

IR2125(S) & (PbF)

Functional Block Diagram

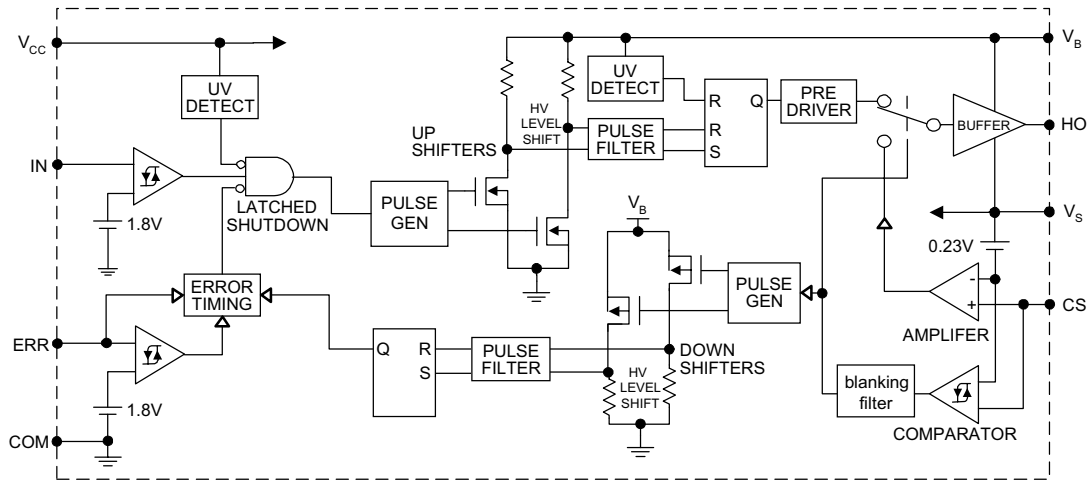

Lead Definitions

Symbol	Description
V _{CC}	Logic and gate drive supply
IN	Logic input for gate driver output (HO), in phase with HO
ERR	Serves multiple functions; status reporting, linear mode timing and cycle by cycle logic shutdown
COM	Logic ground
V _B	High side floating supply
HO	High side gate drive output
V _S	High side floating supply return
CS	Current sense input to current sense comparator

Lead Assignments

<p>8 Lead PDIP</p>	<p>16 Lead SOIC (Wide Body)</p>
IR2125	IR2125S

IR2125(S) & (PbF)

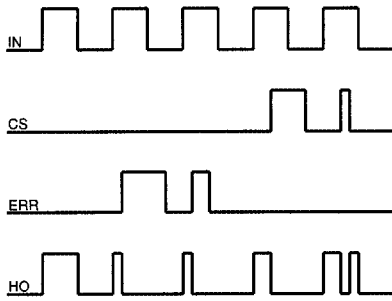

Figure 1. Input/Output Timing Diagram

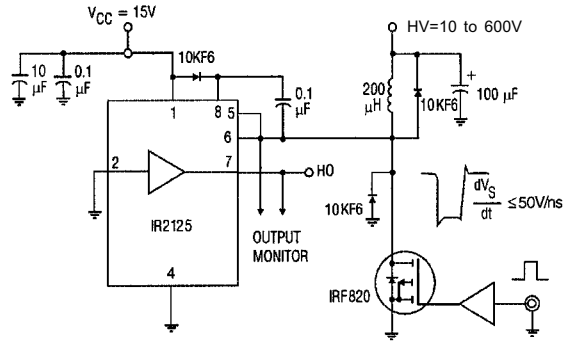

Figure 2. Floating Supply Voltage Transient Test Circuit

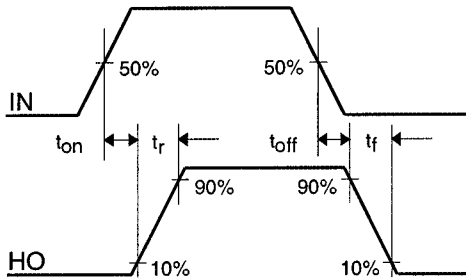

Figure 3. Switching Time Waveform Definitions

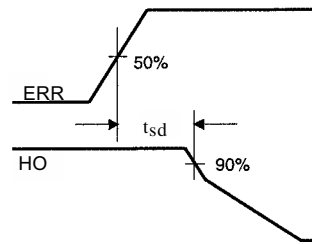

Figure 4. ERR Shutdown Waveform Definitions

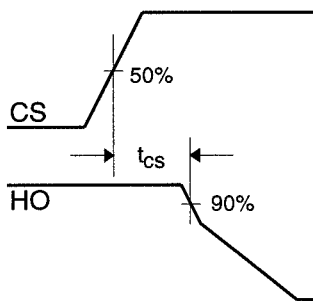

Figure 5. CS Shutdown Waveform Definitions

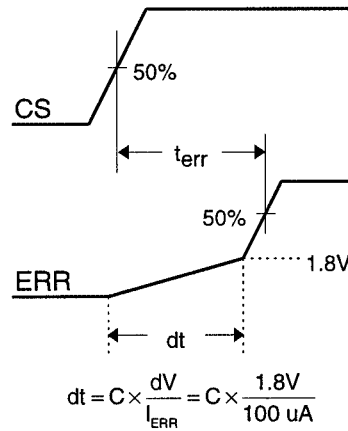

Figure 6. CS to ERR Waveform Definitions

IR2125(S) & (PbF)

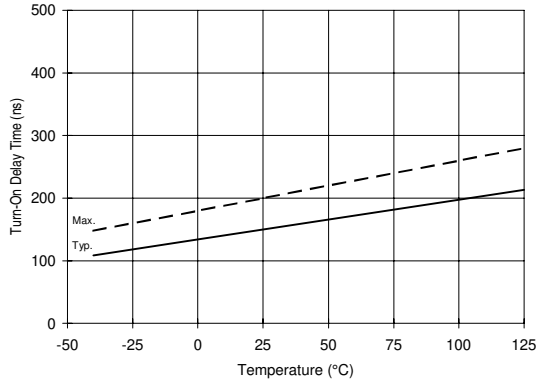

Figure 7A. Turn-On Time vs. Temperature

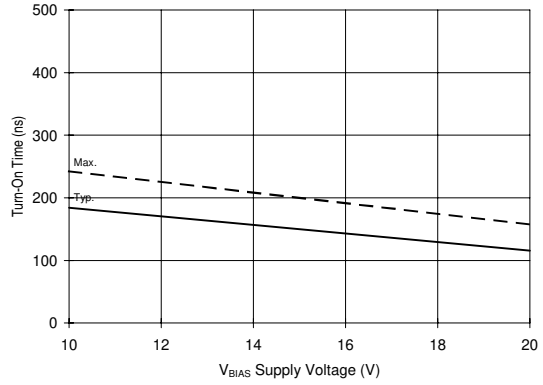

Figure 7B. Turn-On Time vs. Voltage

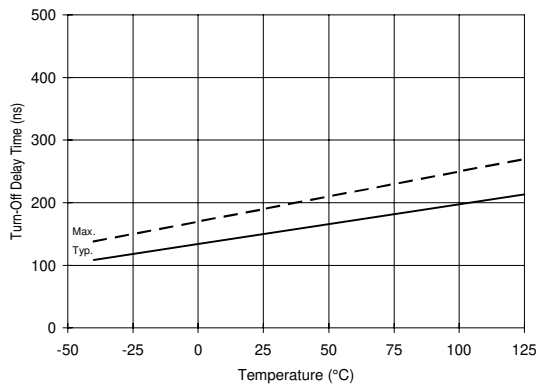

Figure 8A. Turn-Off Time vs. Temperature

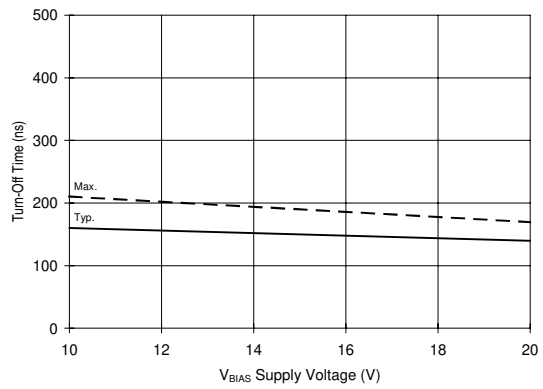

Figure 8B. Turn-Off Time vs. Voltage

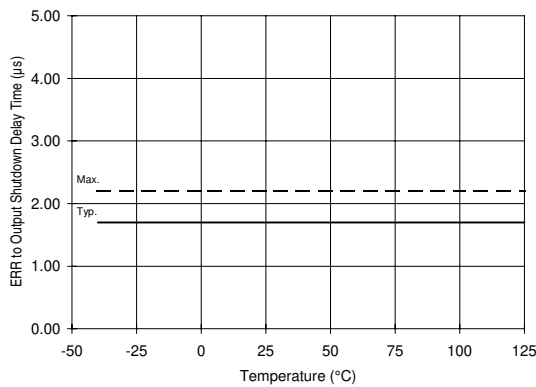

Figure 9A. ERR to Output Shutdown vs. Temperature

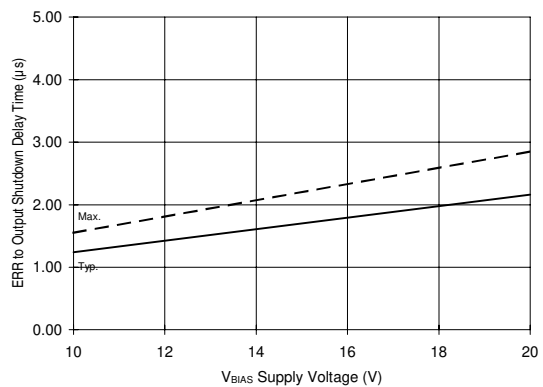

Figure 9B. ERR to Output Shutdown vs. Voltage

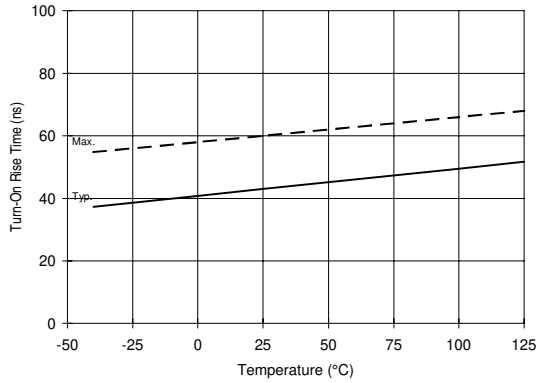

Figure 10A. Turn-On Rise Time vs. Temperature

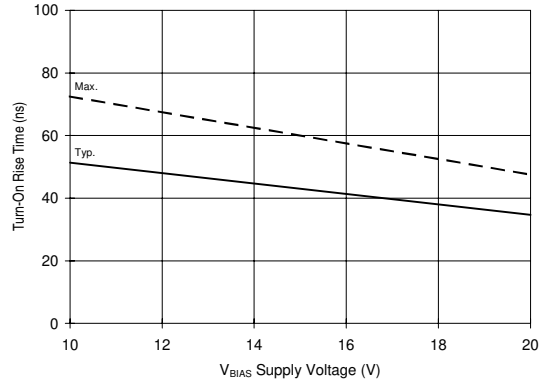

Figure 10B. Turn-On Rise Time vs. Voltage

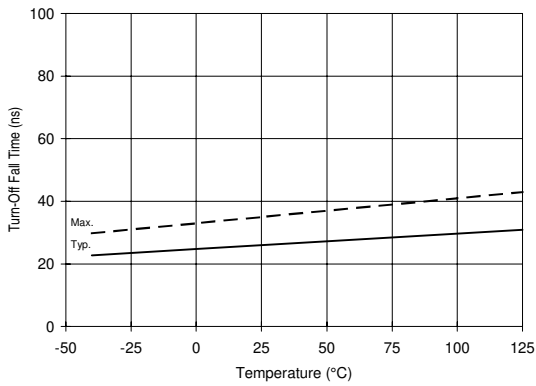

Figure 11A. Turn-Off Fall Time vs. Temperature

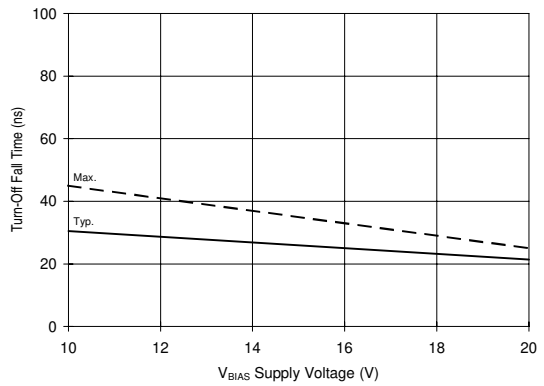

Figure 11B. Turn-Off Fall Time vs. Voltage

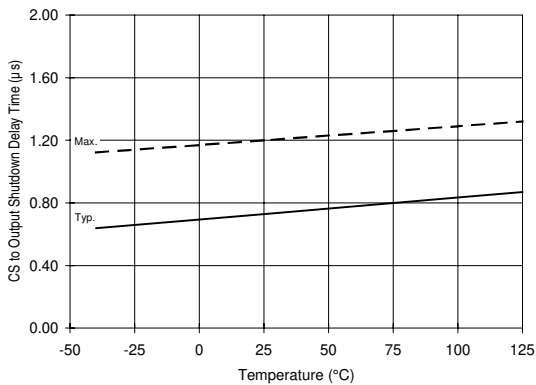

Figure 12A. CS to Output Shutdown vs. Temperature

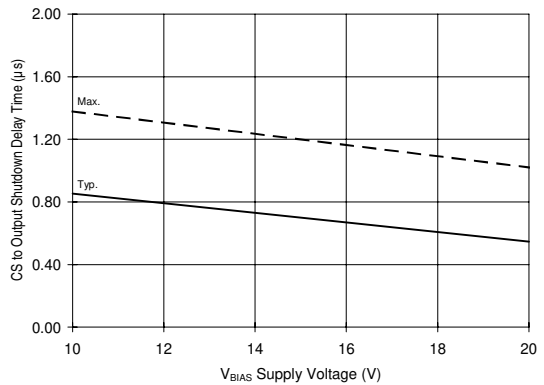

Figure 12B. CS to Output Shutdown vs. Voltage

IR2125(S) & (PbF)

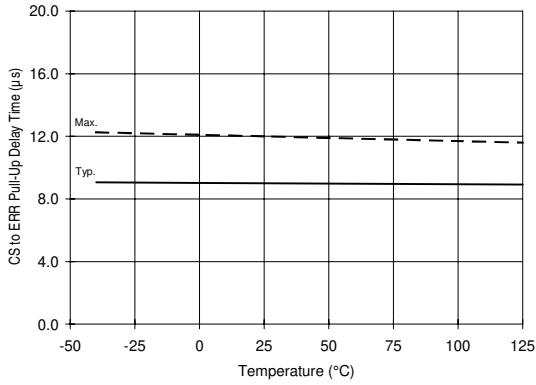

Figure 13A. CS to ERR Pull-Up vs. Temperature

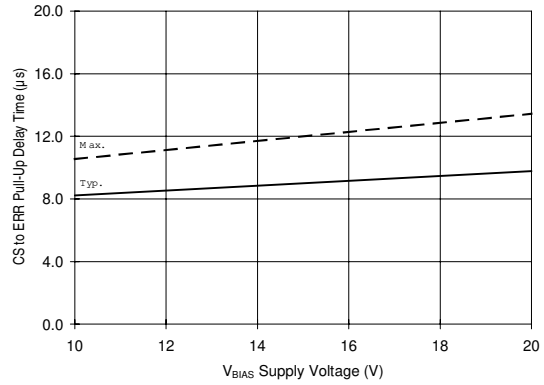

Figure 13B. CS to ERR Pull-Up vs. Voltage

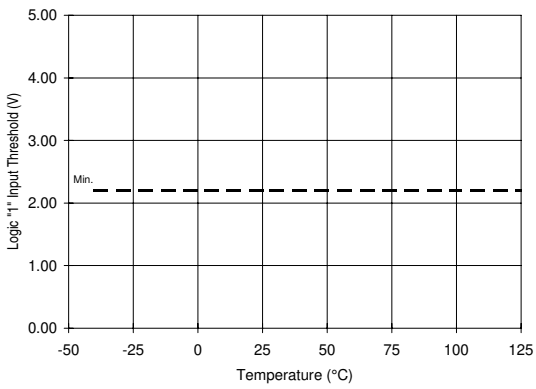

Figure 14A. Logic "1" Input Threshold vs. Temperature

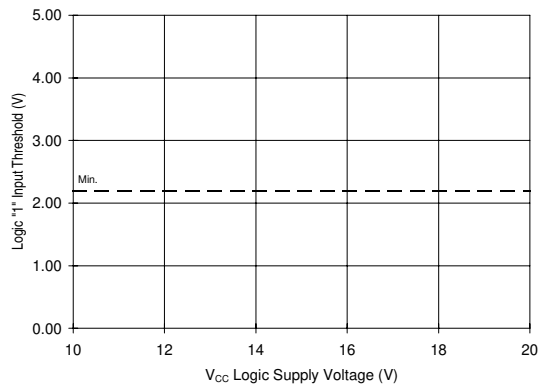

Figure 14B. Logic "1" Input Threshold vs. Voltage

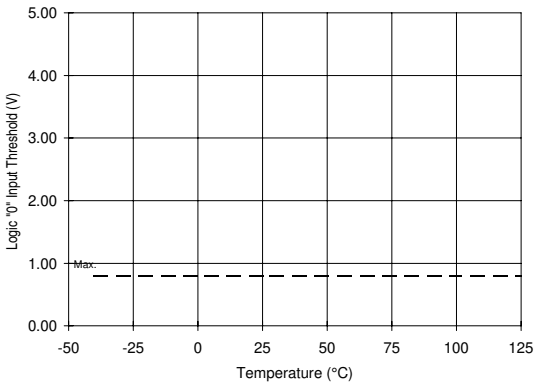

Figure 15A. Logic "0" Input Threshold vs. Temperature

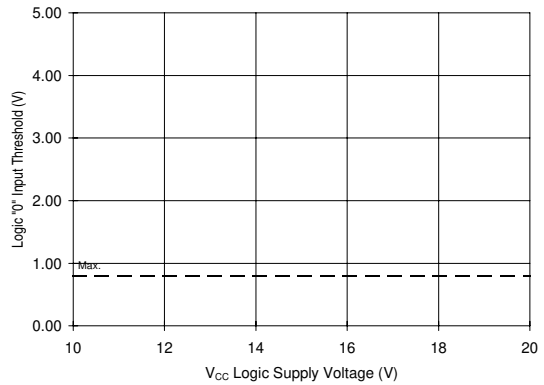

Figure 15B. Logic "0" Input Threshold vs. Voltage

IR2125(S) & (PbF)

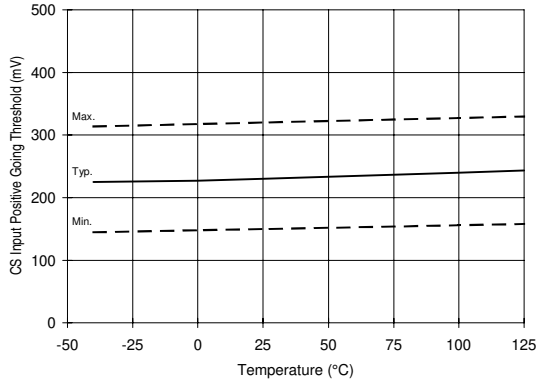

Figure 16A. CS Input Threshold (+) vs. Temperature

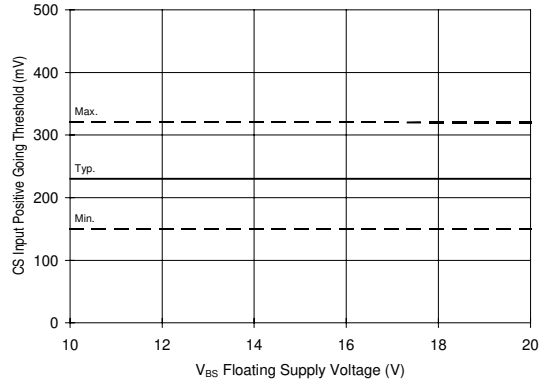

Figure 16B. CS Input Threshold (+) vs. Voltage

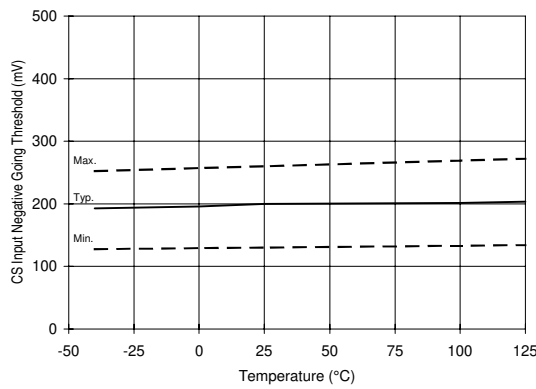

Figure 17A. CS Input Threshold (-) vs. Temperature

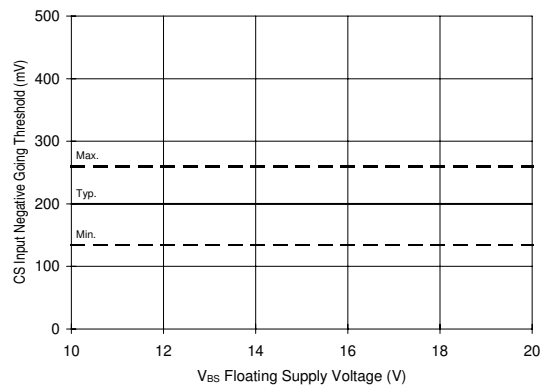

Figure 17B. CS Input Threshold (-) vs. Voltage

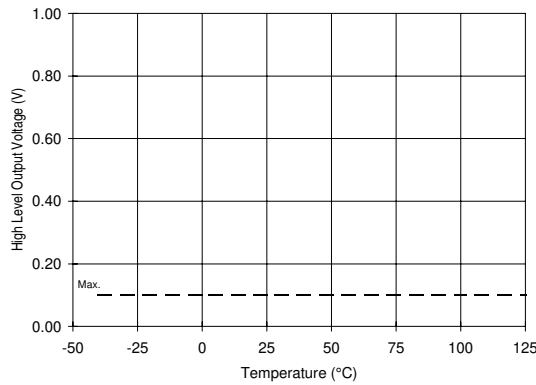

Figure 18A. High Level Output vs. Temperature

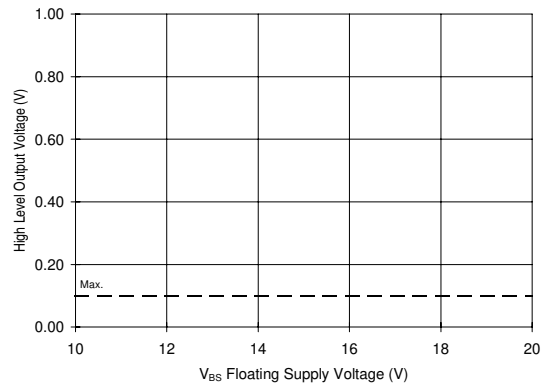

Figure 18B. High Level Output vs. Voltage

IR2125(S) & (PbF)

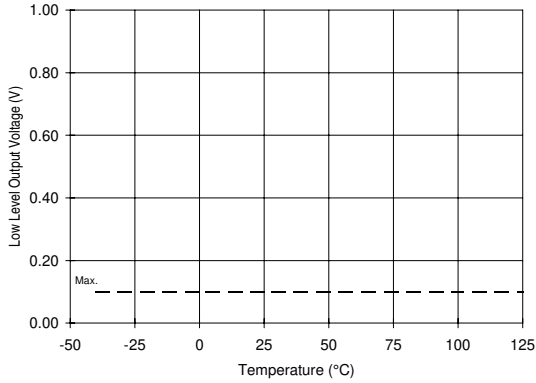

Figure 19A. Low Level Output vs. Temperature

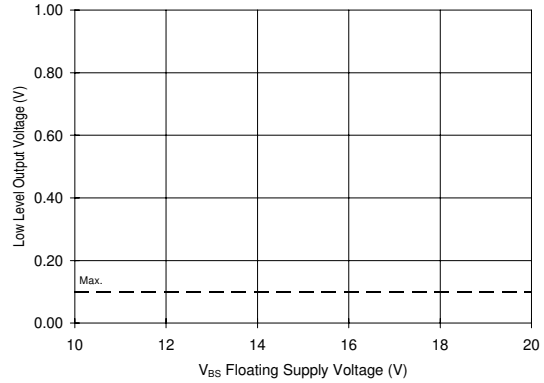

Figure 19B. Low Level Output vs. Voltage

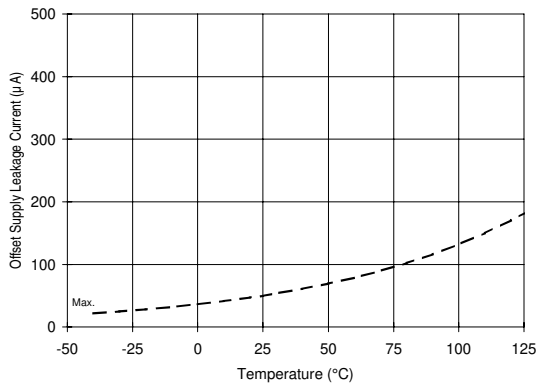

Figure 20A. Offset Supply Current vs. Temperature

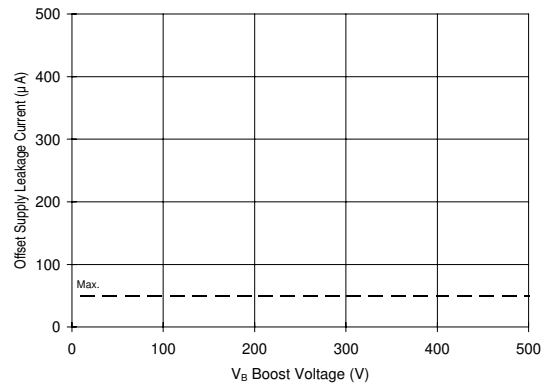

Figure 20B. Offset Supply Current vs. Voltage

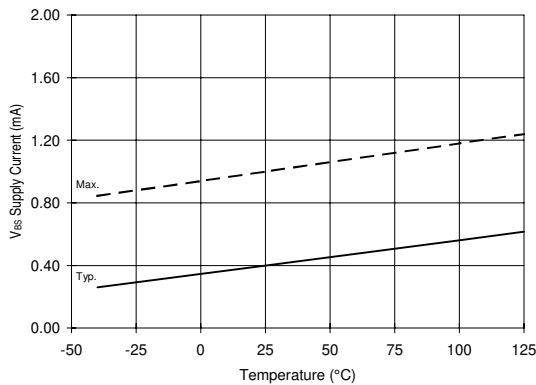

Figure 21A. V_{BS} Supply Current vs. Temperature

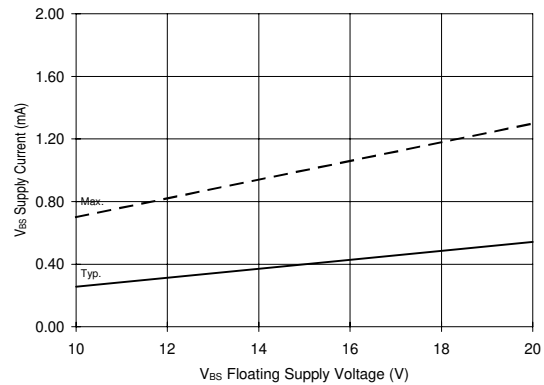

Figure 21B. V_{BS} Supply Current vs. Voltage

IR2125(S) & (PbF)

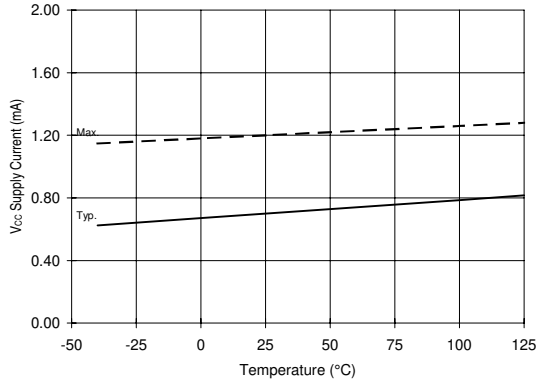

Figure 22A. V_{CC} Supply Current vs. Temperature

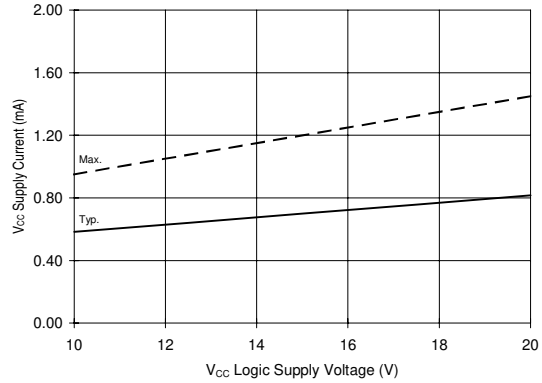

Figure 22B. V_{CC} Supply Current vs. Voltage

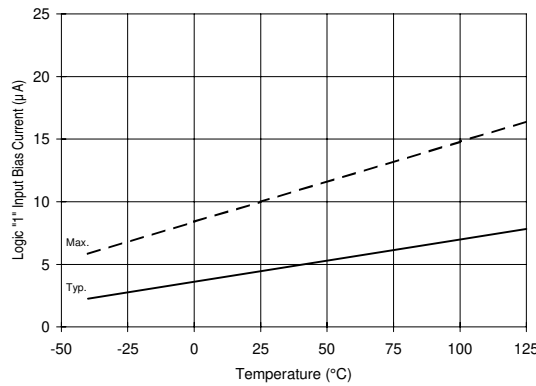

Figure 23A. Logic "1" Input Current vs. Temperature

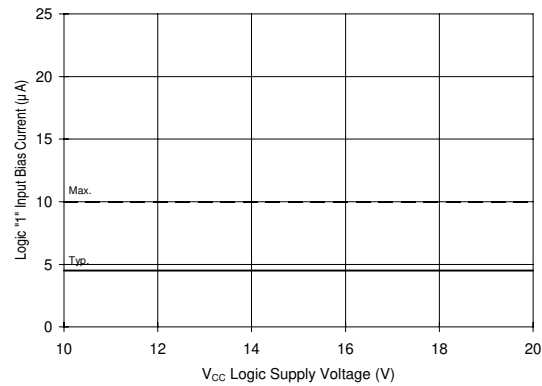

Figure 23B. Logic "1" Input Current vs. Voltage

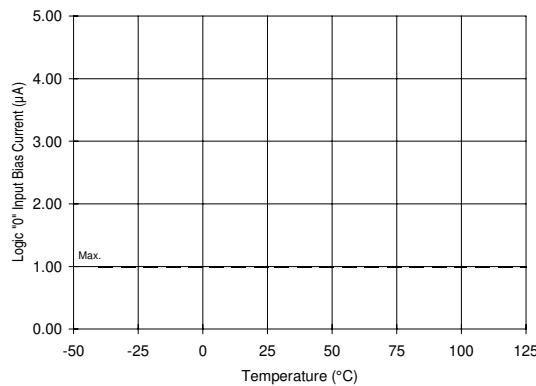

Figure 24A. Logic "0" Input Current vs. Temperature

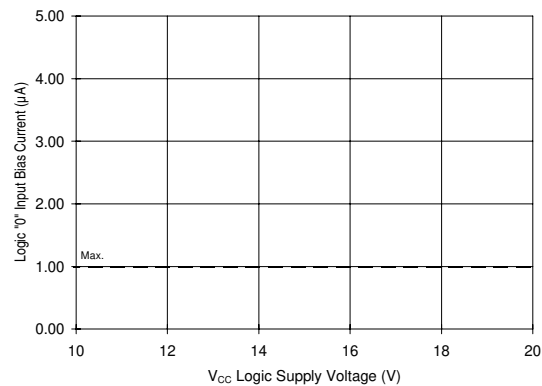

Figure 24B. Logic "0" Input Current vs. Voltage

IR2125(S) & (PbF)

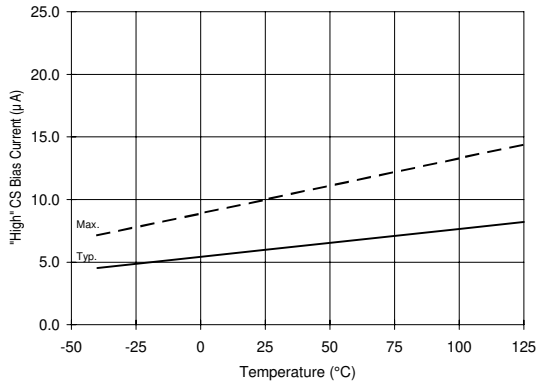

Figure 25A. "High" CS Bias Current vs. Temperature

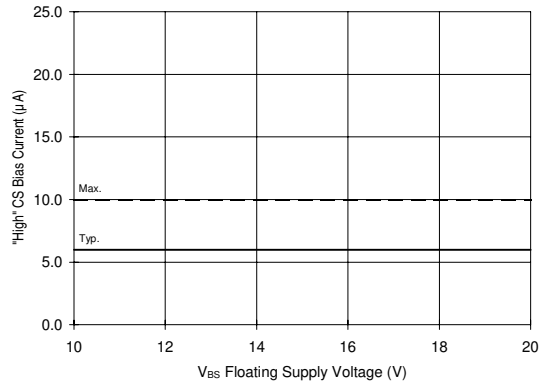

Figure 25B. "High" CS Bias Current vs. Voltage

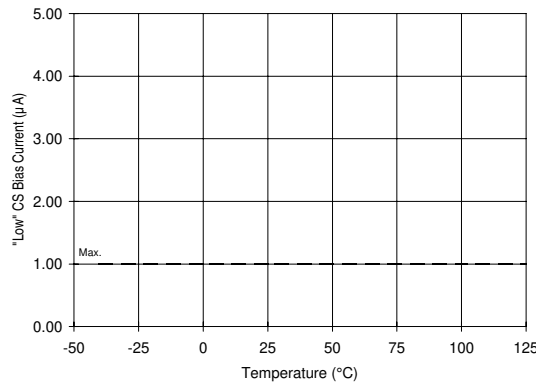

Figure 26A. "Low" CS Bias Current vs. Temperature

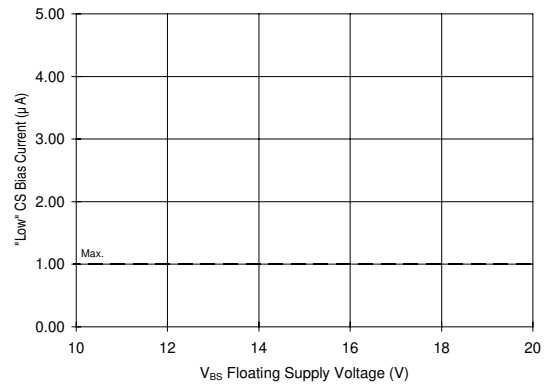

Figure 26B. "Low" CS Bias Current vs. Voltage

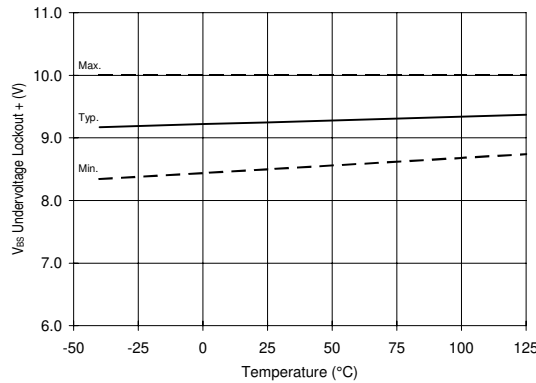

Figure 27. V_{BS} Undervoltage (+) vs. Temperature

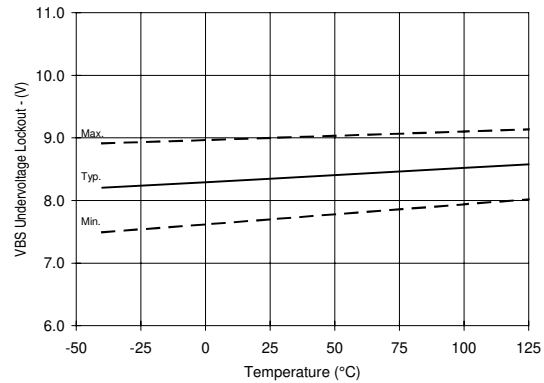

Figure 28. V_{BS} Undervoltage (-) vs. Temperature

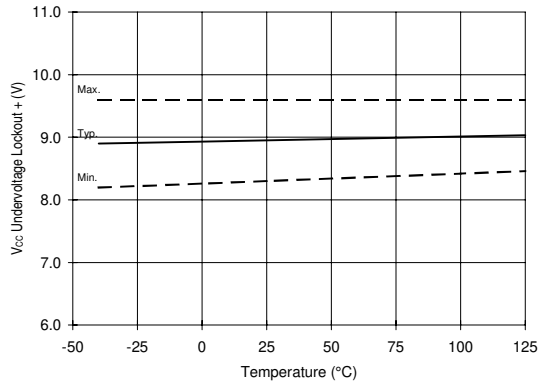

Figure 29. V_{CC} Undervoltage (+) vs. Temperature

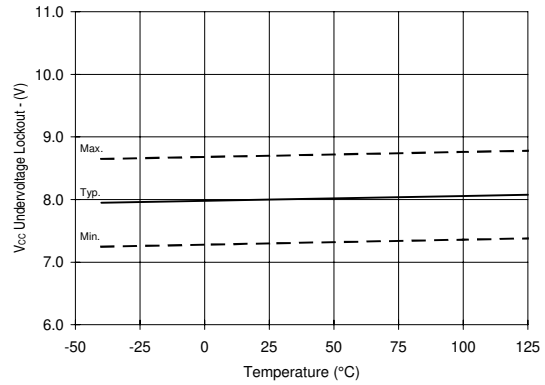

Figure 30. V_{CC} Undervoltage (-) vs. Temperature

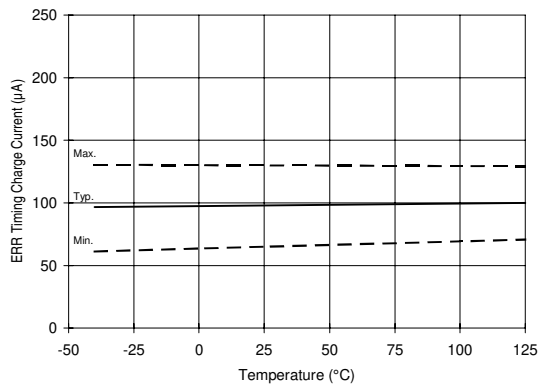

Figure 31A. ERR Timing Charge Current vs. Temperature

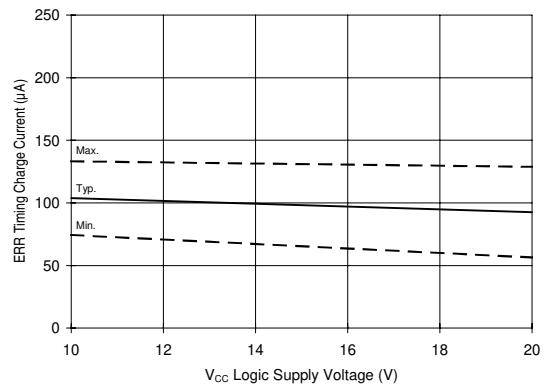

Figure 31B. ERR Timing Charge Current vs. Voltage

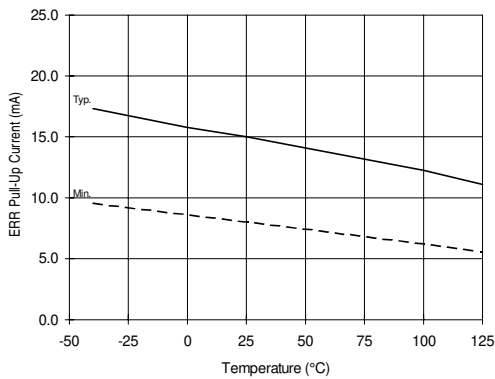

Figure 32A. ERR Pull-Up Current vs. Temperature

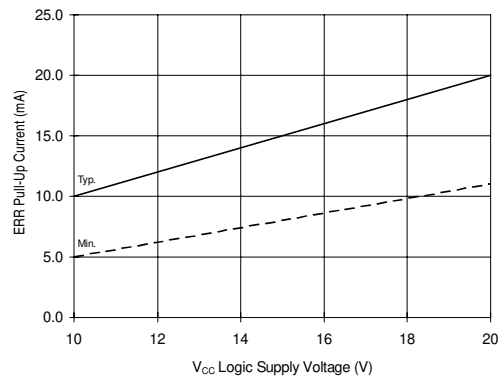

Figure 32B. ERR Pull-Up Current vs. Voltage

IR2125(S) & (PbF)

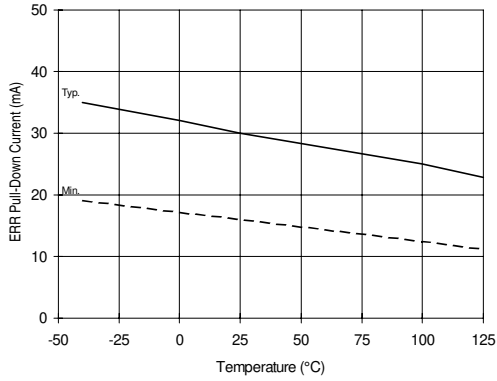

Figure 33A. ERR Pull-Down Current vs. Temperature

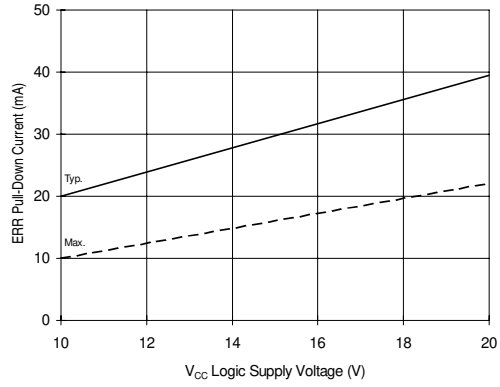

Figure 33B. ERR Pull-Down Current vs. Voltage

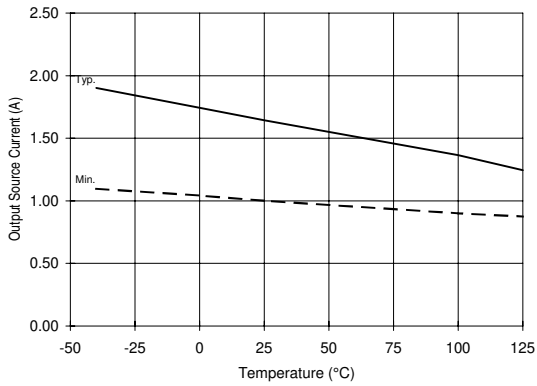

Figure 34A. Output Source Current vs. Temperature

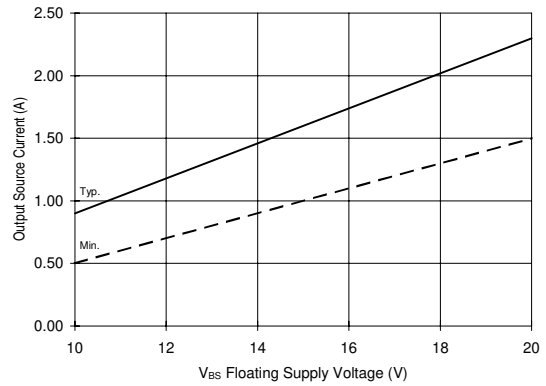

Figure 34B. Output Source Current vs. Voltage

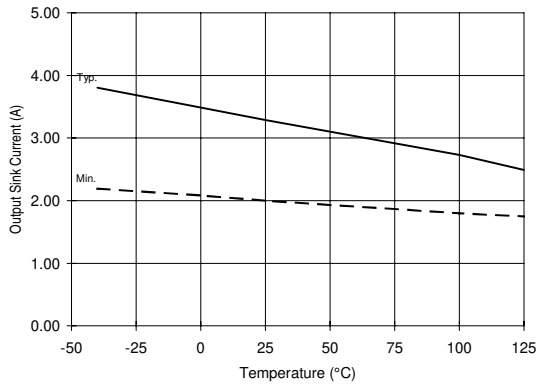

Figure 35A. Output Sink Current vs. Temperature

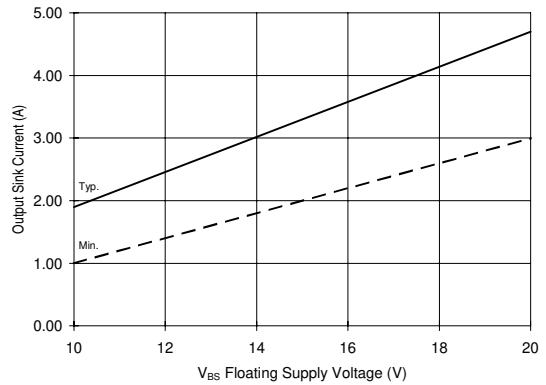

Figure 35B. Output Sink Current vs. Voltage

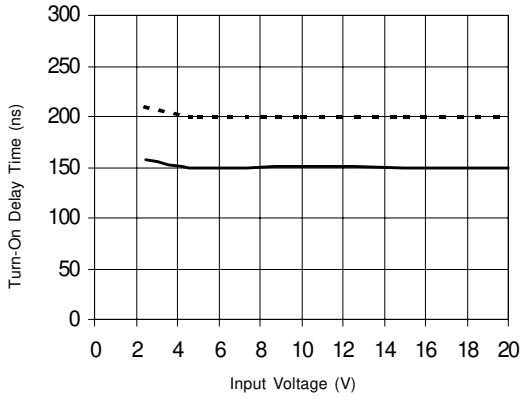

Figure 36A. Turn-On Time vs. Input Voltage

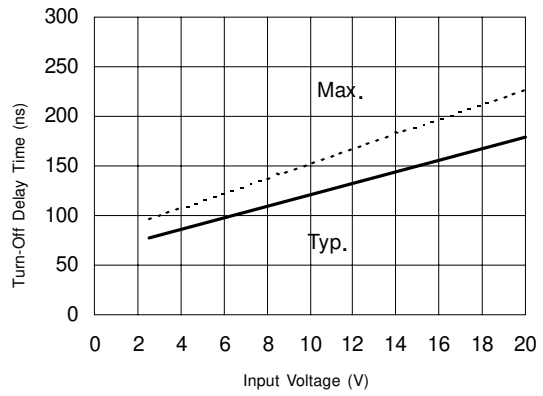

Figure 36B. Turn-Off Time vs. Input Voltage

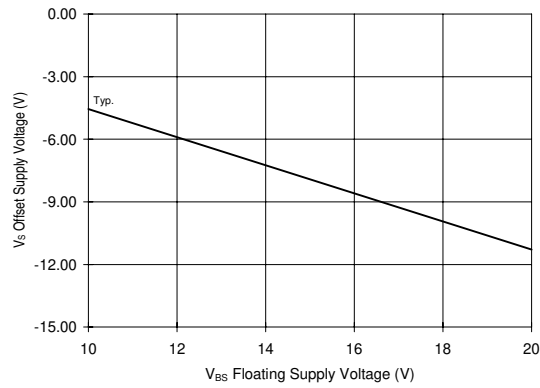
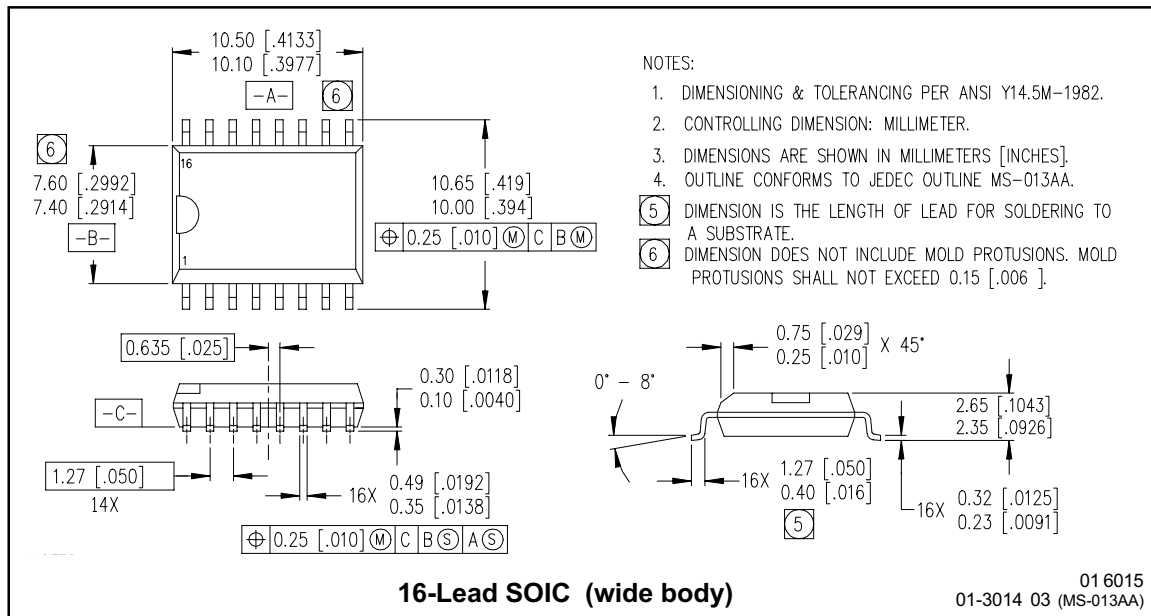
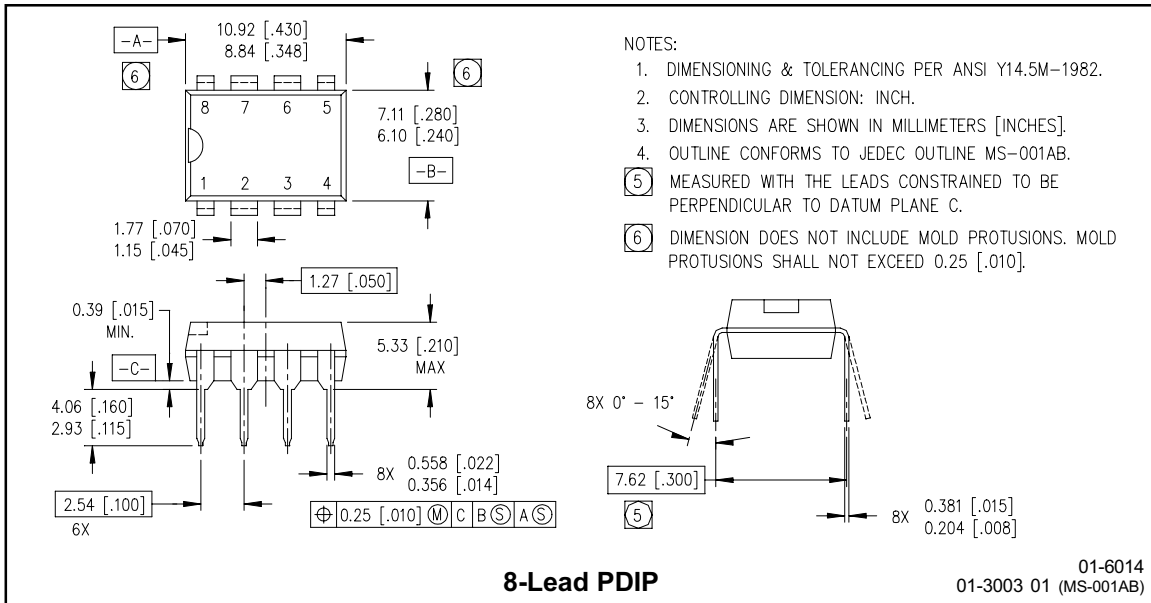

Figure 37. Maximum V_S Negative Offset vs. Supply Voltage

IR2125(S) & (PbF)

Case outlines



LEADFREE PART MARKING INFORMATION

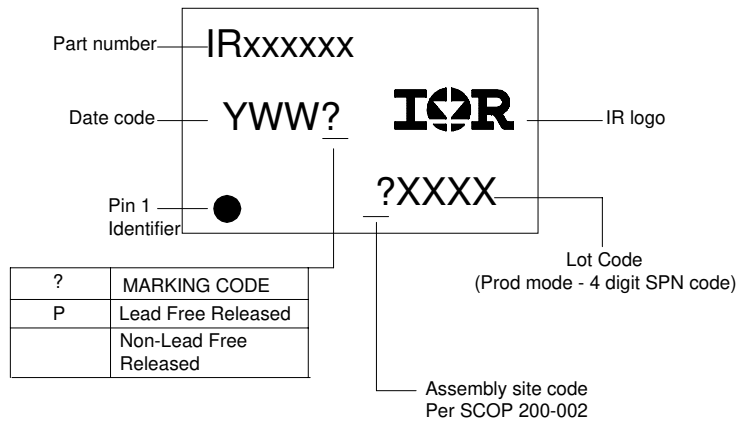

ORDER INFORMATION

Basic Part (Non-Lead Free)

8-Lead PDIP IR2125 order IR2125
 16-Lead SOIC IR2125S order IR2125S

Leadfree Part

8-Lead PDIP IR2125 order IR2125PbF
 16-Lead SOIC IR2125S order IR2125SPbF