



Chipsmall Limited consists of a professional team with an average of over 10 year of expertise in the distribution of electronic components. Based in Hongkong, we have already established firm and mutual-benefit business relationships with customers from,Europe,America and south Asia,supplying obsolete and hard-to-find components to meet their specific needs.

With the principle of “Quality Parts,Customers Priority,Honest Operation,and Considerate Service”,our business mainly focus on the distribution of electronic components. Line cards we deal with include Microchip,ALPS,ROHM,Xilinx,Pulse,ON,Everlight and Freescale. Main products comprise IC,Modules,Potentiometer,IC Socket,Relay,Connector.Our parts cover such applications as commercial,industrial, and automotives areas.

We are looking forward to setting up business relationship with you and hope to provide you with the best service and solution. Let us make a better world for our industry!



## Contact us

Tel: +86-755-8981 8866 Fax: +86-755-8427 6832

Email & Skype: info@chipsmall.com Web: www.chipsmall.com

Address: A1208, Overseas Decoration Building, #122 Zhenhua RD., Futian, Shenzhen, China



# Sup $IR$ Buck™

## INTEGRATED 14A SYNCHRONOUS BUCK REGULATOR

### Features

- Greater than 96% Maximum Efficiency
- Wide Input Voltage Range 1.5V to 16V
- Wide Output Voltage Range 0.7V to 0.9\*Vin
- Continuous 14A Load Capability
- Integrated Bootstrap-diode
- High Bandwidth E/A for excellent transient performance
- Programmable Switching Frequency up to 1.0MHz
- Programmable Over Current Protection
- PGood output
- Hiccup Current Limit
- Precision Reference Voltage (0.7V, +/-1%)
- Programmable Soft-Start
- Enable Input with Voltage Monitoring Capability
- Enhanced Pre-Bias Start-up
- Seq input for Tracking applications
- -40°C to 125°C operating junction temperature
- Thermal Protection
- Pin compatible option for 4A, 8A and 12A devices
- 5mm x 6mm Power QFN package, 0.9 mm height
- Lead-free, halogen-free and RoHS compliant

### Description

The IR3840A **Sup $IR$ Buck™** is an easy-to-use, fully integrated and highly efficient DC/DC synchronous Buck regulator. The MOSFETs co-packaged with the on-chip PWM controller make IR3840A a space-efficient solution, providing accurate power delivery for low output voltage applications.

IR3840A is a versatile regulator which offers programmability of start up time, switching frequency and current limit while operating in wide input and output voltage range.

The switching frequency is programmable from 250kHz to 1.0MHz for an optimum solution.

It also features important protection functions, such as Pre-Bias startup, hiccup current limit and thermal shutdown to give required system level security in the event of fault conditions.

### Applications

- Server Applications
- Storage Applications
- Embedded Telecom Systems
- Distributed Point of Load Power Architectures
- Netcom Applications
- Computing Peripheral Voltage Regulators
- General DC-DC Converters

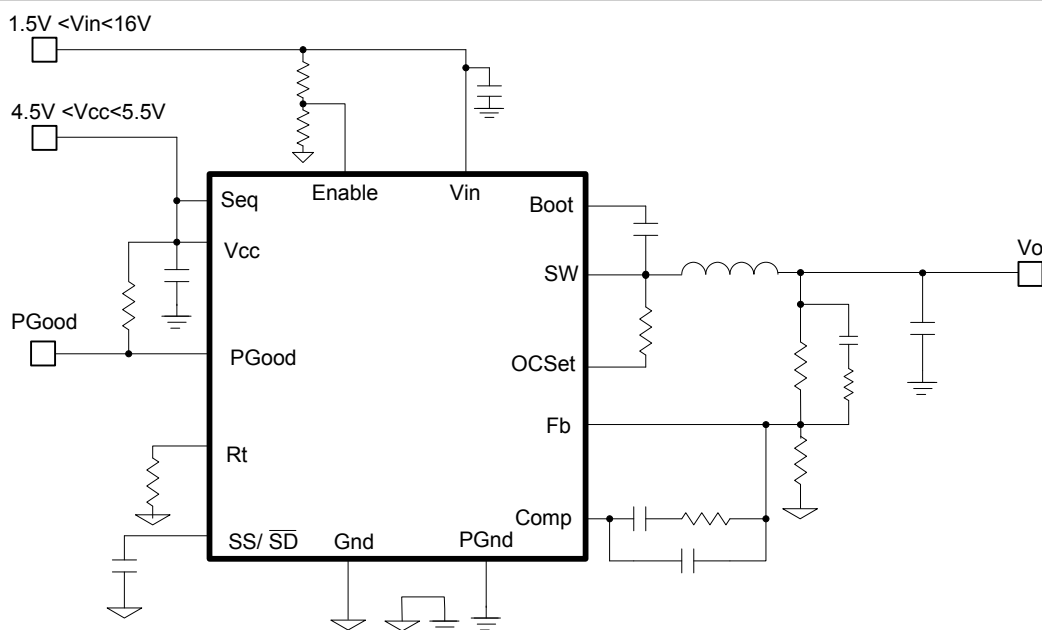

Fig. 1. Typical application diagram

**ABSOLUTE MAXIMUM RATINGS**

(Voltages referenced to GND unless otherwise specified)

- Vin ..... -0.3V to 25V
- Vcc ..... -0.3V to 8V (Note2)
- Boot ..... -0.3V to 33V
- SW ..... -0.3V to 25V(DC), -4V to 25V(AC, 100ns)
- Boot to SW ..... -0.3V to Vcc+0.3V (Note1)
- OCSet ..... -0.3V to 30V, 30mA
- Input / output Pins ..... -0.3V to Vcc+0.3V (Note1)
- PGND to GND ..... -0.3V to +0.3V
- Storage Temperature Range ..... -55°C To 150°C
- Junction Temperature Range ..... -40°C To 150°C (Note2)
- ESD Classification ..... JEDEC Class 1C
- Moisture sensitivity level.....JEDEC Level 2@260 °C (Note5)

**Note1:** Must not exceed 8V

**Note2:** Vcc must not exceed 7.5V for Junction Temperature between -10°C and -40°C

Stresses beyond those listed under “Absolute Maximum Ratings” may cause permanent damage to the device. These are stress ratings only and functional operation of the device at these or any other conditions beyond those indicated in the operational sections of the specifications are not implied.

**PACKAGE INFORMATION**

5mm x 6mm POWER QFN

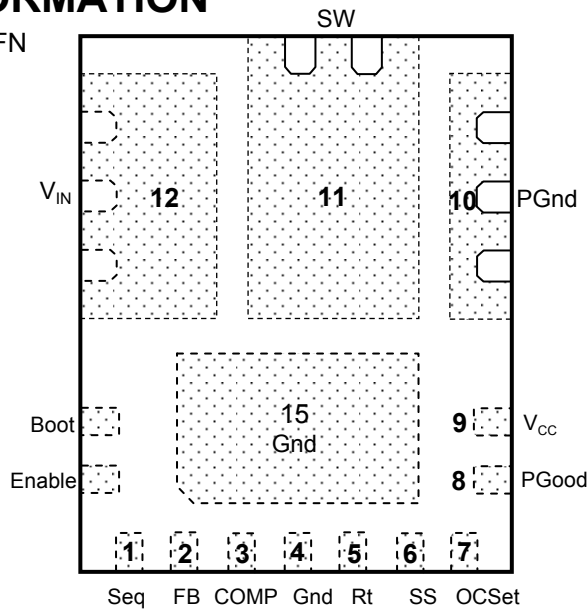

**ORDERING INFORMATION**

PACKAGE DESIGNATOR	PACKAGE DESCRIPTION	PIN COUNT	PARTS PER REEL
M	IR3840AMTRPbF	15	4000
M	IR3840AMTR1PbF	15	750

## Block Diagram

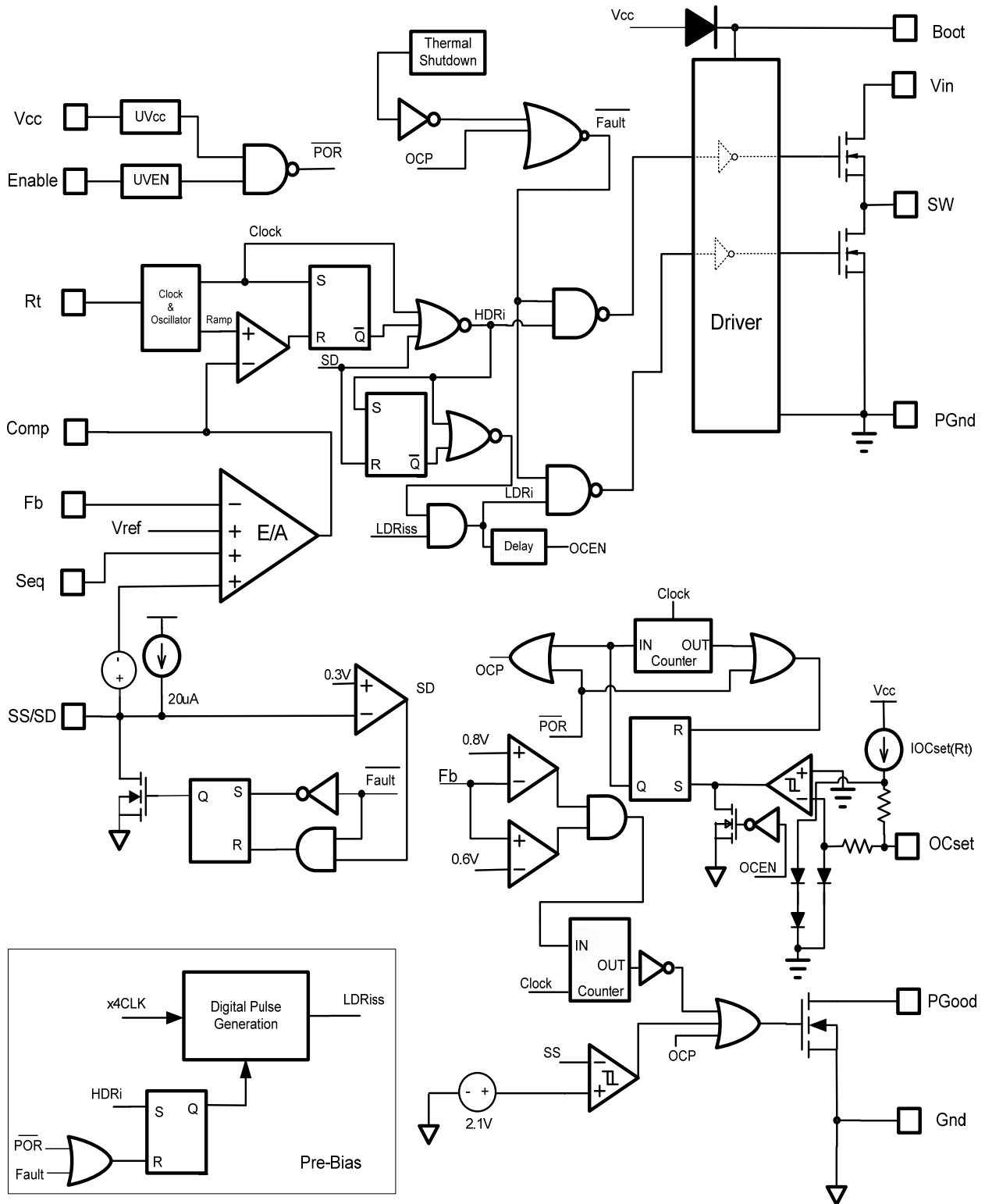

Fig. 2. Simplified block diagram of the IR3840A

## Pin Description

Pin	Name	Description
1	Seq	Sequence pin. Use two external resistors to set Simultaneous Power up sequencing. If this pin is not used connect to Vcc.
2	Fb	Inverting input to the error amplifier. This pin is connected directly to the output of the regulator via resistor divider to set the output voltage and provide feedback to the error amplifier.
3	Comp	Output of error amplifier. An external resistor and capacitor network is typically connected from this pin to Fb pin to provide loop compensation.
4	Gnd	Signal ground for internal reference and control circuitry.
5	Rt	Set the switching frequency. Connect an external resistor from this pin to Gnd to set the switching frequency.
6	SS/ $\overline{SD}$	Soft start / shutdown. This pin provides user programmable soft-start function. Connect an external capacitor from this pin to Gnd to set the start up time of the output voltage. The converter can be shutdown by pulling this pin below 0.3V.
7	OCS <sub>Set</sub>	Current limit set point. A resistor from this pin to SW pin will set the current limit threshold.
8	PGood	Power Good status pin. Output is open drain. Connect a pull up resistor from this pin to Vcc. If unused, it can be left open.
9	V <sub>CC</sub>	This pin powers the internal IC and the drivers. A minimum of 1uF high frequency capacitor must be connected from this pin to the power ground (PGnd).
10	PGnd	Power Ground. This pin serves as a separated ground for the MOSFET drivers and should be connected to the system's power ground plane.
11	SW	Switch node. This pin is connected to the output inductor.
12	V <sub>IN</sub>	Input voltage connection pin.
13	Boot	Supply voltage for high side driver. A 0.1uF capacitor must be connected from this pin to SW.
14	Enable	Enable pin to turn on and off the device. Use two external resistors to set the turn on threshold (see Enable section). Connect this pin to Vcc if it is not used.
15	Gnd	Signal ground for internal reference and control circuitry.

## Recommended Operating Conditions

Symbol	Definition	Min	Max	Units
V <sub>in</sub>	Input Voltage	1.5	16	V
V <sub>cc</sub>	Supply Voltage	4.5	5.5	
Boot to SW	Supply Voltage	4.5	5.5	
V <sub>o</sub>	Output Voltage	0.7	0.9*V <sub>in</sub>	
I <sub>o</sub>	Output Current	0	14	A
F <sub>s</sub>	Switching Frequency	225	1000	kHz
T <sub>j</sub>	Junction Temperature	-40	125	°C

## Electrical Specifications

Unless otherwise specified, these specification apply over 4.5V < V<sub>cc</sub> < 5.5V, V<sub>in</sub>=12V, 0°C < T<sub>j</sub> < 125°C.  
 Typical values are specified at T<sub>a</sub> = 25°C.

Parameter	Symbol	Test Condition	Min	TYP	MAX	Units
<b>Power Loss</b>						
Power Loss	P <sub>loss</sub>	V <sub>cc</sub> =5V, V <sub>in</sub> =12V, V <sub>o</sub> =1.8V, I <sub>o</sub> =14A, F <sub>s</sub> =600kHz, L=0.56uH, <i>Note4</i>		3.63		W
<b>MOSFET R<sub>ds(on)</sub></b>						
Top Switch	R <sub>ds(on)_Top</sub>	V <sub>boot</sub> -V <sub>sw</sub> =5V, I <sub>D</sub> =14A, T <sub>J</sub> =25°C		8.4	10.6	mΩ
Bottom Switch	R <sub>ds(on)_Bot</sub>	V <sub>cc</sub> =5V, I <sub>D</sub> =14A, T <sub>J</sub> =25°C		5.7	6.9	
<b>Reference Voltage</b>						
Feedback Voltage	V <sub>FB</sub>			0.7		V
Accuracy		0°C < T <sub>J</sub> < 125°C	-1.0		+1.0	%
		-40°C < T <sub>J</sub> < 125°C, <i>Note3</i>	-2.0		+2.0	
<b>Supply Current</b>						
V <sub>cc</sub> Supply Current (Standby)	I <sub>cc(Standby)</sub>	SS=0V, No Switching, Enable low			500	uA
V <sub>cc</sub> Supply Current (Dyn)	I <sub>cc(Dyn)</sub>	SS=3V, V <sub>cc</sub> =5V, F <sub>s</sub> =500kHz Enable high		15		mA
<b>Under Voltage Lockout</b>						
V <sub>cc</sub> -Start-Threshold	V <sub>CC_UVLO_Start</sub>	V <sub>cc</sub> Rising Trip Level	3.95	4.15	4.35	V
V <sub>cc</sub> -Stop-Threshold	V <sub>CC_UVLO_Stop</sub>	V <sub>cc</sub> Falling Trip Level	3.65	3.85	4.05	
Enable-Start-Threshold	Enable_UVLO_Start	Supply ramping up	1.14	1.2	1.36	
Enable-Stop-Threshold	Enable_UVLO_Stop	Supply ramping down	0.9	1.0	1.06	
Enable leakage current	I <sub>en</sub>	Enable=3.3V			15	

### Electrical Specifications (continued)

Unless otherwise specified, these specification apply over  $4.5V < V_{cc} < 5.5V$ ,  $V_{in} = 12V$ ,  $0^{\circ}C < T_j < 125^{\circ}C$ .  
 Typical values are specified at  $T_a = 25^{\circ}C$ .

Parameter	Symbol	Test Condition	Min	TYP	MAX	Units
<b>Oscillator</b>						
Rt Voltage			0.665	0.7	0.735	V
Frequency	$F_s$	Rt=59K	225	250	275	kHz
		Rt=28.7K	450	500	550	
		Rt=14.3K, <i>Note4</i>	900	1000	1100	
Ramp Amplitude	$V_{ramp}$	<i>Note4</i>		1.8		Vp-p
Ramp Offset	Ramp (os)	<i>Note4</i>		0.6		V
Min Pulse Width	$D_{min}(ctrl)$	<i>Note4</i>		50		ns
Fixed Off Time		<i>Note4</i>		130	200	
Max Duty Cycle	$D_{max}$	$F_s=250kHz$	92			%
<b>Error Amplifier</b>						
Input Offset Voltage	$V_{os}$	$V_{fb}-V_{seq}$ , $V_{seq}=0.8V$	-10	0	+10	mV
Input Bias Current	$I_{fb}(E/A)$		-1		+1	$\mu A$
Input Bias Current	$I_{vp}(E/A)$		-1		+1	
Sink Current	$I_{sink}(E/A)$		0.40	0.85	1.2	mA
Source Current	$I_{source}(E/A)$		8	10	13	
Slew Rate	SR	<i>Note4</i>	7	12	20	V/ $\mu s$
Gain-Bandwidth Product	GBWP	<i>Note4</i>	20	30	40	MHz
DC Gain	Gain	<i>Note4</i>	100	110	120	dB
Maximum Voltage	$V_{max}(E/A)$	$V_{cc}=4.5V$	3.4	3.5	3.75	V
Minimum Voltage	$V_{min}(E/A)$			120	220	mV
Common Mode Voltage		<i>Note4</i>	0		1	V
<b>Soft Start/SD</b>						
Soft Start Current	ISS	Source	14	20	26	$\mu A$
Soft Start Clamp Voltage	$V_{ss}(clamp)$		2.7	3.0	3.3	
Shutdown Output Threshold	SD				0.3	V
<b>Over Current Protection</b>						
OCSET Current	$I_{OCSET}$	$F_s=250kHz$	20.8	23.6	26.4	$\mu A$
		$F_s=500kHz$	43	48.8	54.6	
OC Comp Offset Voltage	$V_{OFFSET}$	<i>Note4</i>	-10	0	+10	mV
SS off time	SS_Hiccup			4096		Cycles
<b>Bootstrap Diode</b>						
Forward Voltage		$I(Boot)=30mA$	180	260	470	mV
<b>Deadband</b>						
Deadband time		<i>Note4</i>	5	10	30	ns

### Electrical Specifications (continued)

Unless otherwise specified, these specification apply over  $4.5V < V_{cc} < 5.5V$ ,  $V_{in} = 12V$ ,  $0^{\circ}C < T_j < 125^{\circ}C$ .  
Typical values are specified at  $T_a = 25^{\circ}C$ .

Parameter	SYM	Test Condition	Min	TYP	MAX	Units
<b>Thermal Shutdown</b>						
Thermal Shutdown		Note4		140		°C
Hysteresis		Note4		20		
<b>Power Good</b>						
Power Good upper Threshold	VPG(upper)	Fb Rising	0.770	0.805	0.840	V
Upper Threshold Delay	VPG(upper)_Dly	Fb Rising		256/Fs		s
Power Good lower Threshold	VPG(lower)	Fb Falling	0.560	0.595	0.630	V
Lower Threshold Delay	VPG(lower)_Dly	Fb Falling		256/Fs		s
Delay Comparator Threshold	PG(Delay)	Relative to charge voltage, SS rising	2	2.1	2.3	V
Delay Comparator Hysteresis	Delay(hys)	Note4	260	300	340	mV
PGood Voltage Low	PG(voltage)	$I_{PGood} = -5mA$			0.5	V
Leakage Current	$I_{leakage}$			0	10	μA
<b>Switch Node</b>						
SW Bias Current	Isw	SW=0V, Enable=0V			6	μA
		SW=0V, Enable=high, SS=3V, Vseq=0V, Note4				

**Note3:** Cold temperature performance is guaranteed via correlation using statistical quality control. Not tested in production.

**Note4:** Guaranteed by Design but not tested in production.

**Note5:** Upgrade to industrial/MSL2 level applies from date codes 1227 (marking explained on application note [AN1132](#) page 2). Products with prior date code of 1227 are qualified with MSL3 for Consumer market.



**Typical Efficiency and Power Loss Curves**

Vin=12V, Vcc=5V, Io=2A-14A, F<sub>s</sub>=600kHz, Room Temperature, No Air Flow

The table below shows the inductors used for each of the output voltages in the efficiency measurement.

Vout (V)	L (μH)	P/N	DCR (mΩ)
0.90	0.22	59PR9873N	0.29
1.00	0.3	59PR9874N	0.29
1.10	0.3	59PR9874N	0.29
1.20	0.3	59PR9874N	0.29
1.50	0.4	59PR9875N	0.29
1.80	0.56	MPC1040LR56	1.3
2.50	0.56	MPC1040LR56	1.3
3.30	0.88	MPC1040LR88	2.3
5.00	0.88	MPC1040LR88	2.3

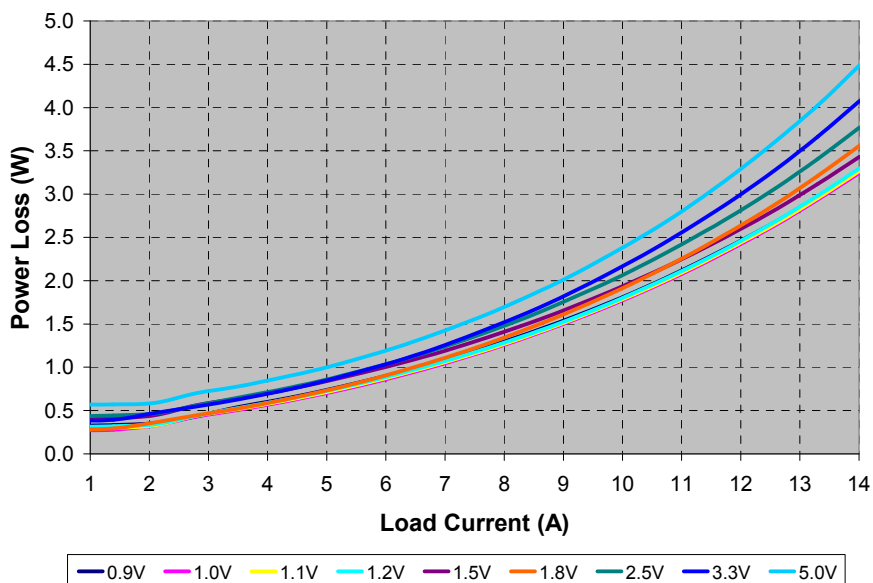
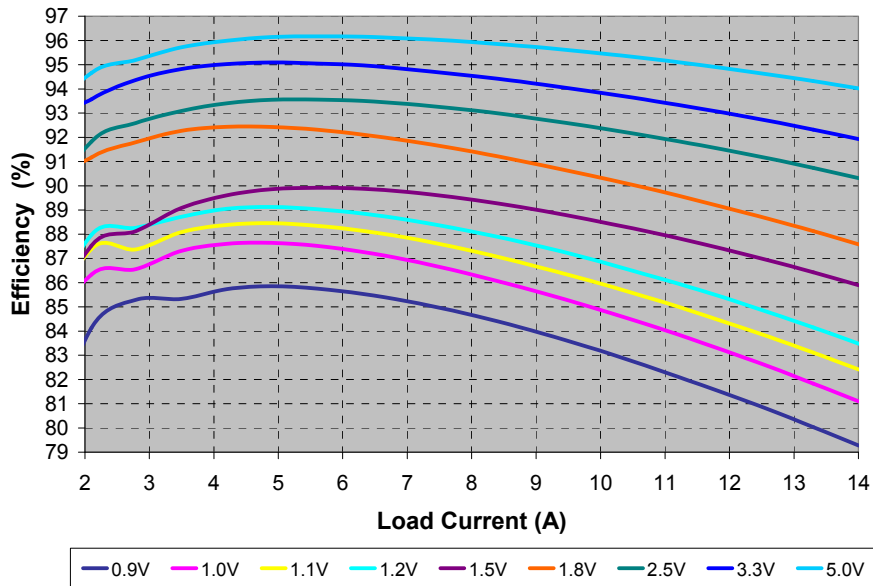

**Typical Efficiency and Power Loss Curves**

Vin=5V, Vcc=5V, Io=2A-14A, F<sub>s</sub>=600kHz, Room Temperature, No Air Flow

The table below shows the inductors used for each of the output voltages in the efficiency measurement.

Vout (V)	L(μH)	P/N	DCR (mΩ)
0.70	0.22	59PR9873N	0.29
0.75	0.22	59PR9873N	0.29
0.90	0.22	59PR9873N	0.29
1.00	0.22	59PR9873N	0.29
1.10	0.3	59PR9874N	0.29
1.20	0.3	59PR9874N	0.29
1.50	0.3	59PR9874N	0.29
1.80	0.4	59PR9875N	0.29
2.50	0.4	59PR9875N	0.29
3.30	0.4	59PR9875N	0.29

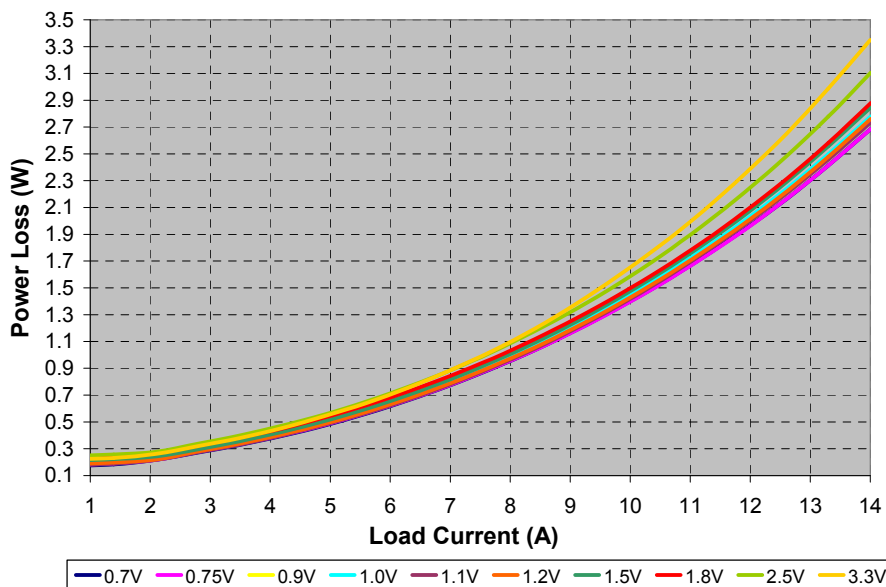
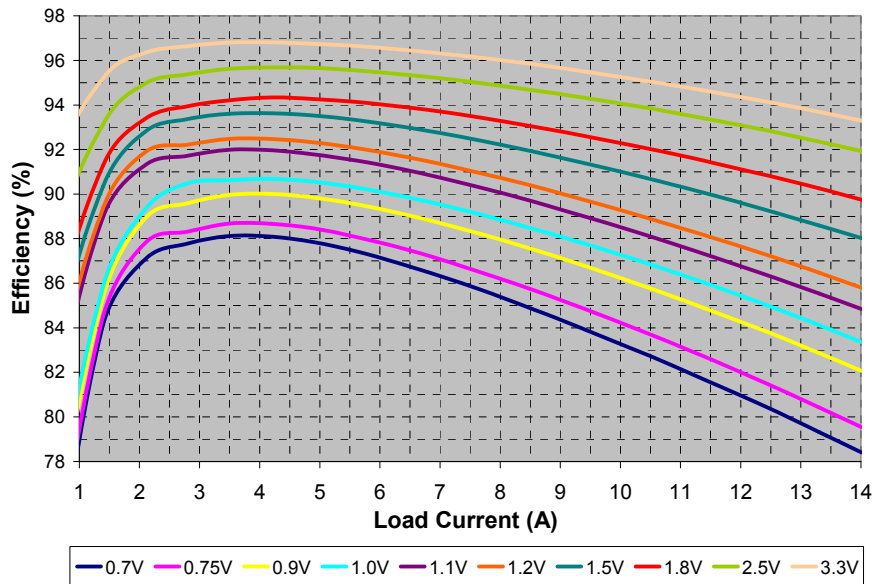

**TYPICAL OPERATING CHARACTERISTICS (-40°C - 125°C)  $F_s = 500$  kHz**

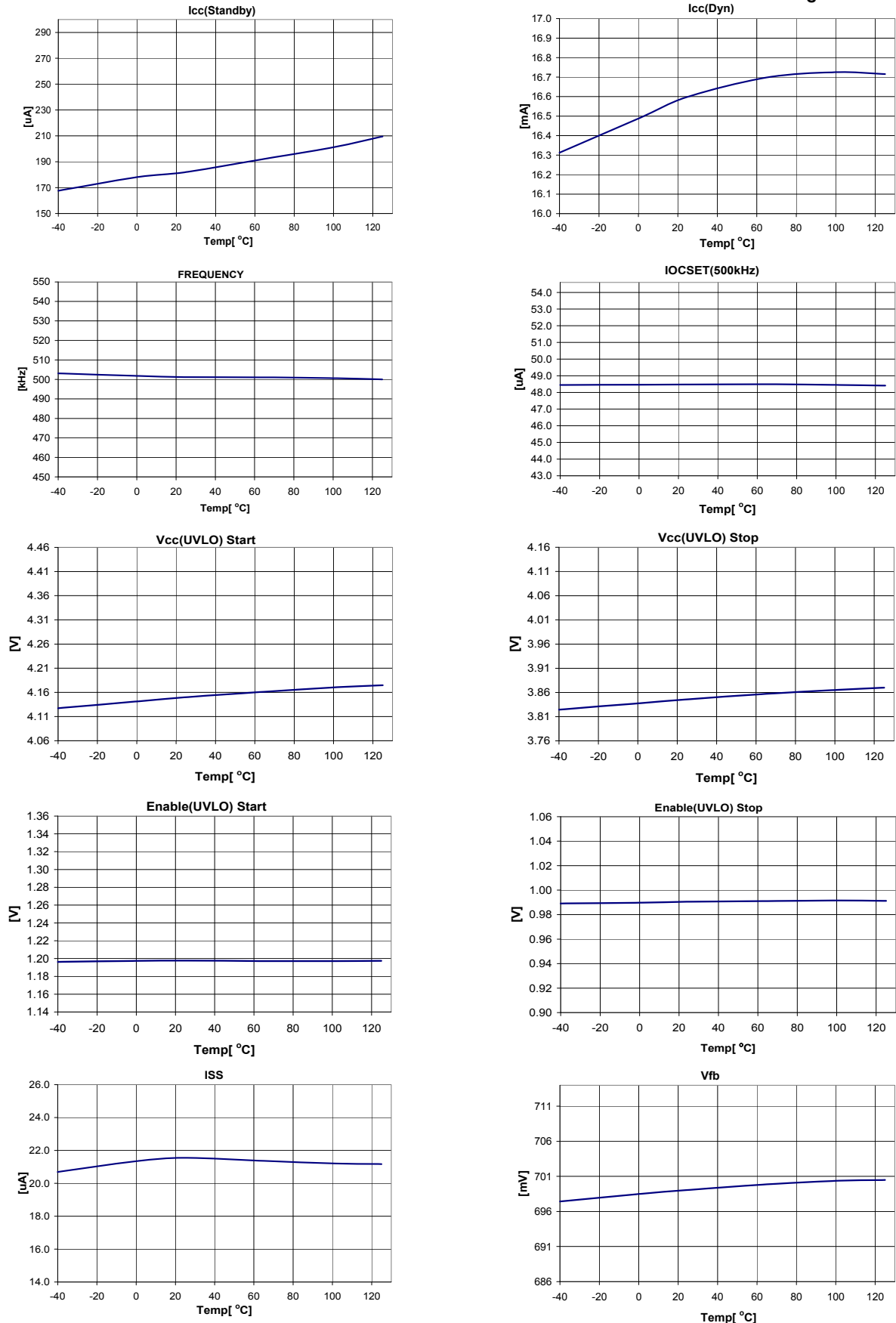

**Rdson of MOSFETs Over Temperature at Vcc=5V**

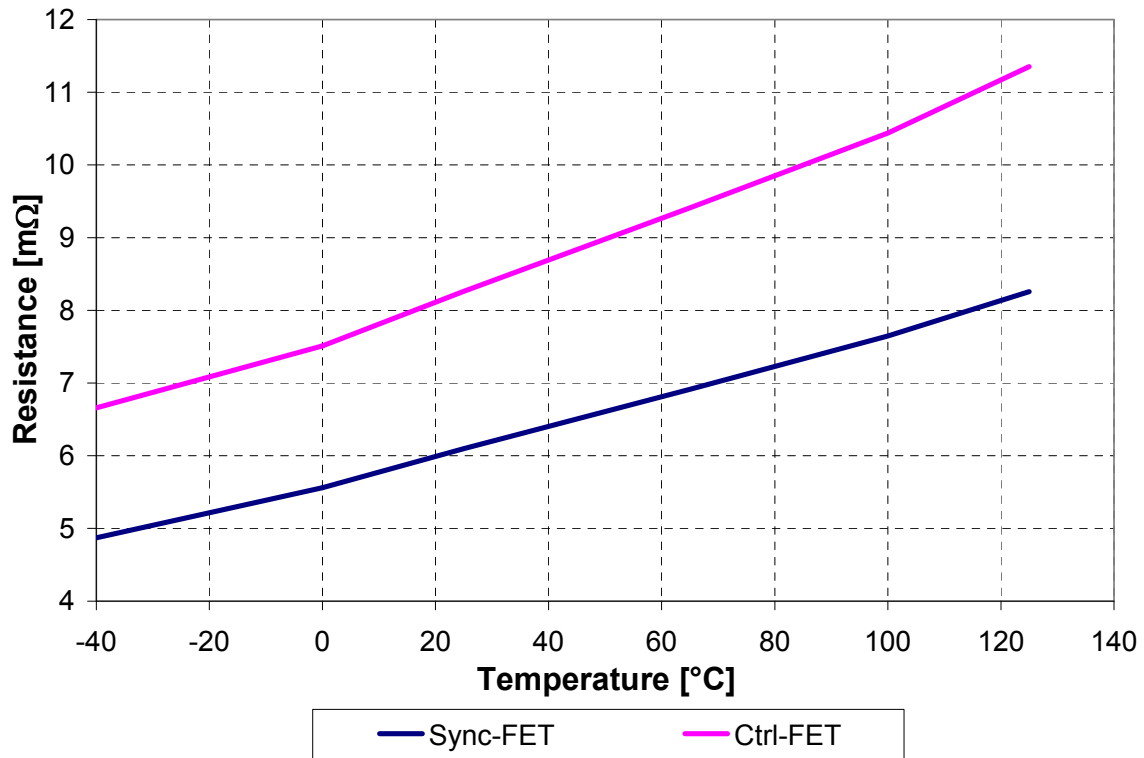

**Thermal De-rating Curves**

Test Conditions: Vin=12V, Vout=1.8V, Vcc=5V, Fs=600kHz, 0- 400LFM  
L=0.6uH (MPL104-0R6IR)

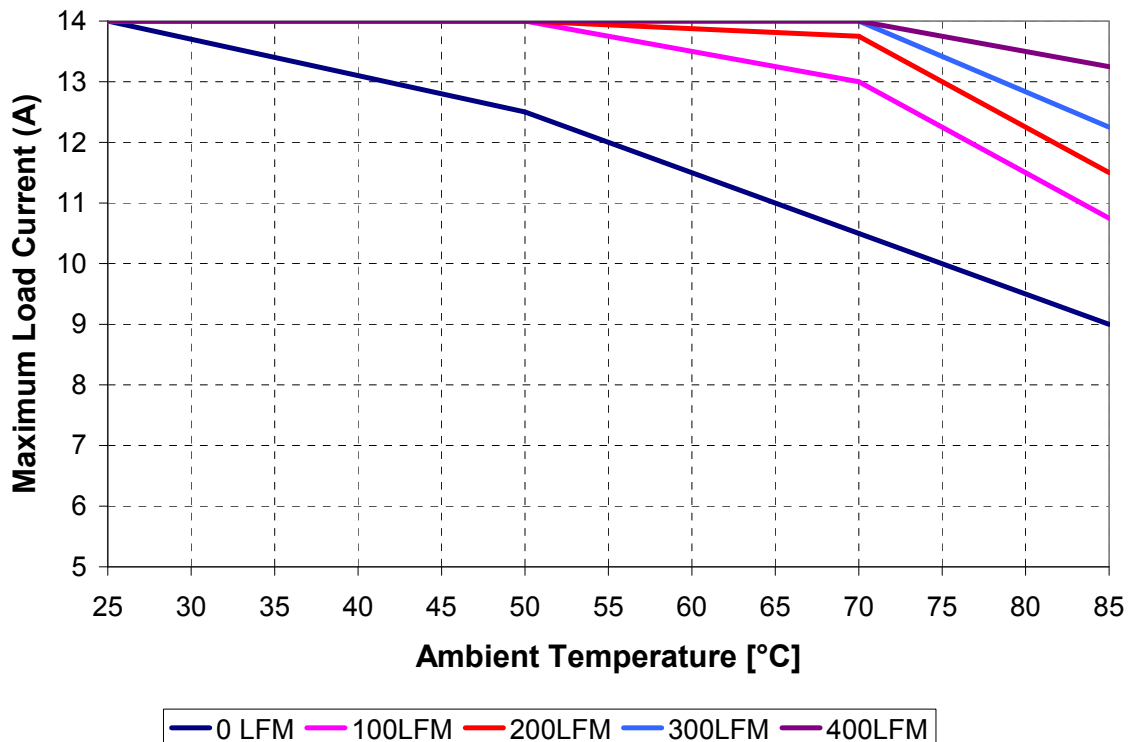

## Circuit Description

### THEORY OF OPERATION

#### Introduction

The IR3840A uses a PWM voltage mode control scheme with external compensation to provide good noise immunity and maximum flexibility in selecting inductor values and capacitor types.

The switching frequency is programmable from 250kHz to 1.5MHz and provides the capability of optimizing the design in terms of size and performance.

IR3840A provides precisely regulated output voltage programmed via two external resistors from 0.7V to 0.9\* $V_{in}$ .

The IR3840A operates with an external bias supply from 4.5V to 5.5V, allowing an extended operating input voltage range from 1.5V to 16V.

The device utilizes the on-resistance of the low side MOSFET as current sense element, this method enhances the converter's efficiency and reduces cost by eliminating the need for external current sense resistor.

IR3840A includes two low  $R_{ds(on)}$  MOSFETs using IR's HEXFET technology. These are specifically designed for high efficiency applications.

#### Under-Voltage Lockout and POR

The under-voltage lockout circuit monitors the input supply  $V_{cc}$  and the Enable input. It assures that the MOSFET driver outputs remain in the off state whenever either of these two signals drop below the set thresholds. Normal operation resumes once  $V_{cc}$  and Enable rise above their thresholds.

The POR (Power On Ready) signal is generated when all these signals reach the valid logic level (see system block diagram). When the POR is asserted the soft start sequence starts (see soft start section).

#### Enable

The Enable features another level of flexibility for start up. The Enable has precise threshold which is internally monitored by Under-Voltage Lockout (UVLO) circuit. Therefore, the IR3840A will turn on only when the voltage at the Enable pin exceeds this threshold, typically, 1.2V.

If the input to the Enable pin is derived from the bus voltage by a suitably programmed resistive divider, it can be ensured that the IR3840A does not turn on until the bus voltage reaches the desired level. Only after the bus voltage reaches or exceeds this level will the voltage at Enable pin exceed its threshold, thus enabling the IR3840A. Therefore, in addition to being a logic input pin to enable the IR3840A, the Enable feature, with its precise threshold, also allows the user to implement an Under-Voltage Lockout for the bus voltage  $V_{in}$ . This is desirable particularly for high output voltage applications, where we might want the IR3840A to be disabled at least until  $V_{in}$  exceeds the desired output voltage level.

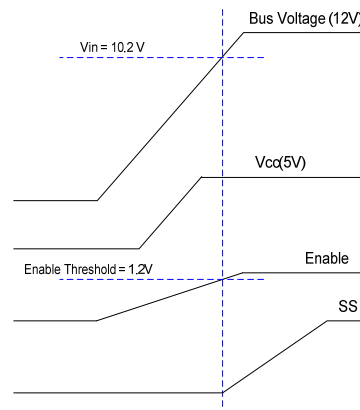

Fig. 3a. Normal Start up, Device turns on when the Bus voltage reaches 10.2V

Figure 3b. shows the recommended start-up sequence for the non-sequenced operation of IR3840A, when Enable is used as a logic input.

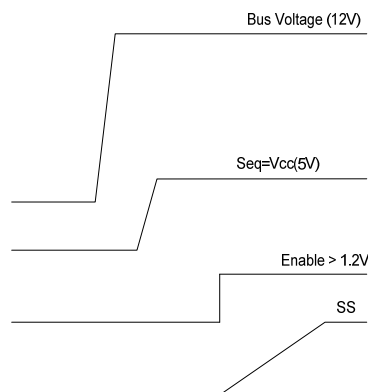

Fig. 3b. Recommended startup sequence, Non-Sequenced operation

Figure 3c. shows the recommended startup sequence for sequenced operation of IR3840A with Enable used as logic input.

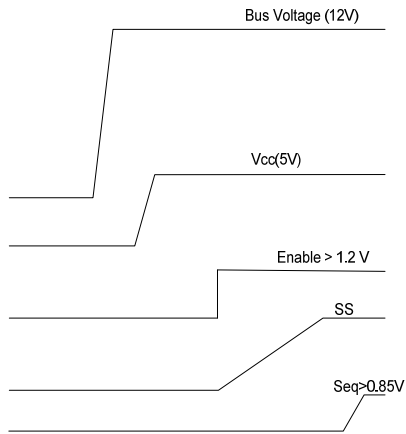

Fig. 3c. Recommended startup sequence, Sequenced operation

**Pre-Bias Startup**

IR3840A is able to start up into pre-charged output, which prevents oscillation and disturbances of the output voltage.

The output starts in asynchronous fashion and keeps the synchronous MOSFET off until the first gate signal for control MOSFET is generated. Figure 4 shows a typical Pre-Bias condition at start up.

The synchronous MOSFET always starts with a narrow pulse width and gradually increases its duty cycle with a step of 25%, 50%, 75% and 100% until it reaches the steady state value. The number of these startup pulses for the synchronous MOSFET is internally programmed. Figure 5 shows a series of 32, 16, 8 startup pulses.

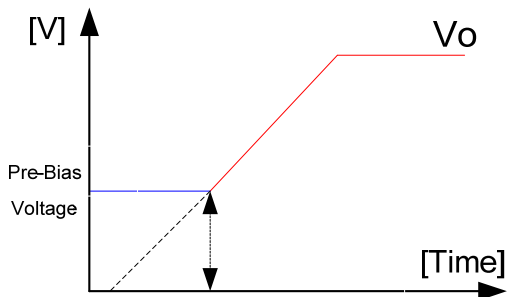

Fig. 4. Pre-Bias startup

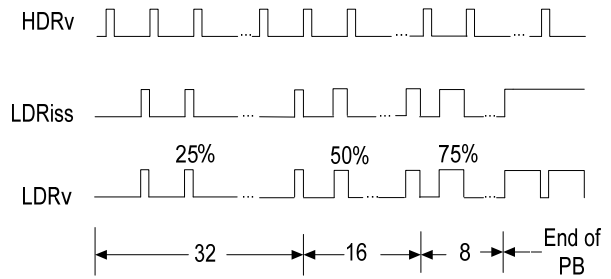

Fig. 5. Pre-Bias startup pulses

**Soft-Start**

The IR3840A has a programmable soft-start to control the output voltage rise and to limit the current surge at the start-up. To ensure correct start-up, the soft-start sequence initiates when the Enable and Vcc rise above their UVLO thresholds and generate the Power On Ready (POR) signal. The internal current source (typically 20uA) charges the external capacitor C<sub>ss</sub> linearly from 0V to 3V. Figure 6 shows the waveforms during the soft start.

The start up time can be estimated by:

$$T_{start} = \frac{(1.4 - 0.7) * C_{ss}}{20\mu A} \dots\dots\dots (1)$$

During the soft start the OCP is enabled to protect the device for any short circuit and over current condition.

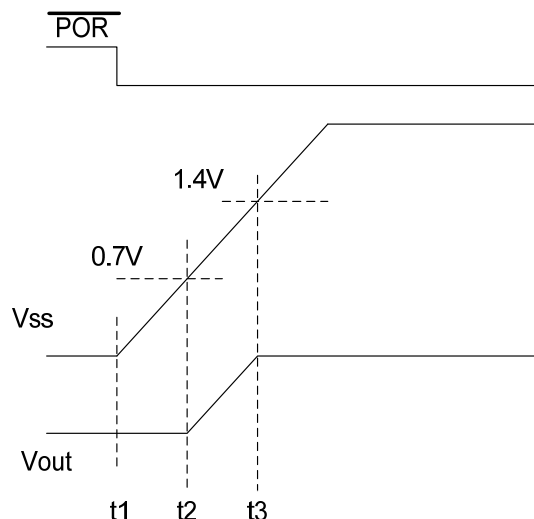

Fig. 6. Theoretical operation waveforms during soft-start

**Operating Frequency**

The switching frequency can be programmed between 250kHz – 1500kHz by connecting an external resistor from R<sub>t</sub> pin to Gnd. Table 1 tabulates the oscillator frequency versus R<sub>t</sub>.

Table 1. Switching Frequency and I<sub>OCSet</sub> vs. External Resistor (R<sub>t</sub>)

R <sub>t</sub> (kΩ)	F <sub>s</sub> (kHz)	I <sub>OCSet</sub> (μA)
47.5	300	29.4
35.7	400	39.2
28.7	500	48.7
23.7	600	59.07
20.5	700	68.2
17.8	800	78.6
15.8	900	88.6
14.3	1000	97.9

**Shutdown**

The IR3840A can be shutdown by pulling the Enable pin below its 1 V threshold. This will tri-state both, the high side driver as well as the low side driver. Alternatively, the output can be shutdown by pulling the soft-start pin below 0.3V. Normal operation is resumed by cycling the voltage at the Soft Start pin.

**Over-Current Protection**

The over current protection is performed by sensing current through the R<sub>DS(on)</sub> of low side MOSFET. This method enhances the converter’s efficiency and reduces cost by eliminating a current sense resistor. As shown in figure 7, an external resistor (R<sub>OCSet</sub>) is connected between OCSet pin and the switch node (SW) which sets the current limit set point.

An internal current source sources current (I<sub>OCSet</sub>) out of the OCSet pin. This current is a function of the switching frequency and hence, of R<sub>t</sub>.

$$I_{OCSet} (\mu A) = \frac{1400}{R_t (k\Omega)} \dots\dots\dots(2)$$

Table 1. shows I<sub>OCSet</sub> at different switching frequencies. The internal current source develops a voltage across R<sub>OCSet</sub>. When the low side MOSFET is turned on, the inductor current flows through the Q2 and results in a voltage at OCSet which is given by:

$$V_{OCSet} = (I_{OCSet} * R_{OCSet}) - (R_{DS(on)} * I_L) \dots\dots\dots(3)$$

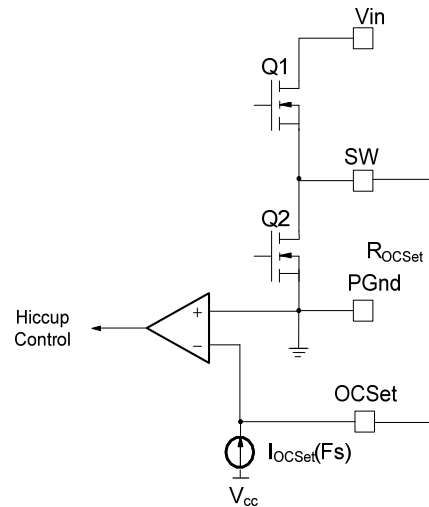

Fig. 7. Connection of over current sensing resistor

An over current is detected if the OCSet pin goes below ground. Hence, at the current limit threshold, V<sub>OCSet</sub>=0. Then, for a current limit setting I<sub>Limit</sub>, R<sub>OCSet</sub> is calculated as follows:

$$R_{OCSet} = \frac{R_{DS(on)} * I_{Limit}}{I_{OCSet}} \dots\dots\dots(4)$$

An overcurrent detection trips the OCP comparator, latches OCP signal and cycles the soft start function in hiccup mode.

The hiccup is performed by shorting the soft-start capacitor to ground and counting the number of switching cycles. The Soft Start pin is held low until 4096 cycles have been completed. The OCP signal resets and the converter recovers. After every soft start cycle, the converter stays in this mode until the overload or short circuit is removed.

The OCP circuit starts sampling current typically 160 ns after the low gate drive rises to about 3V. This delay functions to filter out switching noise.

### Thermal Shutdown

Temperature sensing is provided inside IR3840A. The trip threshold is typically set to 140°C. When trip threshold is exceeded, thermal shutdown turns off both MOSFETs and discharges the soft start capacitor.

Automatic restart is initiated when the sensed temperature drops within the operating range. There is a 20°C hysteresis in the thermal shutdown threshold.

### Output Voltage Sequencing

The IR3840A can accommodate user programmable sequencing options using Seq, Enable and Power Good pins.

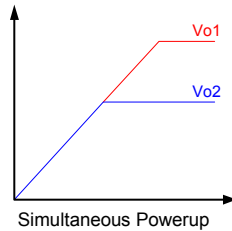

Fig. 8a. Simultaneous Power-up of the slave with respect to the master.

Through these pins, voltage sequencing such as simultaneous and sequential can be implemented. Figure 8. shows simultaneous sequencing configurations. In simultaneous power-up, the voltage at the Seq pin of the slave reaches 0.7V before the Fb pin of the master. For  $R_E/R_F = R_C/R_D$ , therefore, the output voltage of the slave follows that of the master until the voltage at the Seq pin of the slave reaches 0.7 V. After the voltage at the Seq pin of the slave exceeds 0.85V, the internal 0.7V reference of the slave dictates its output voltage.

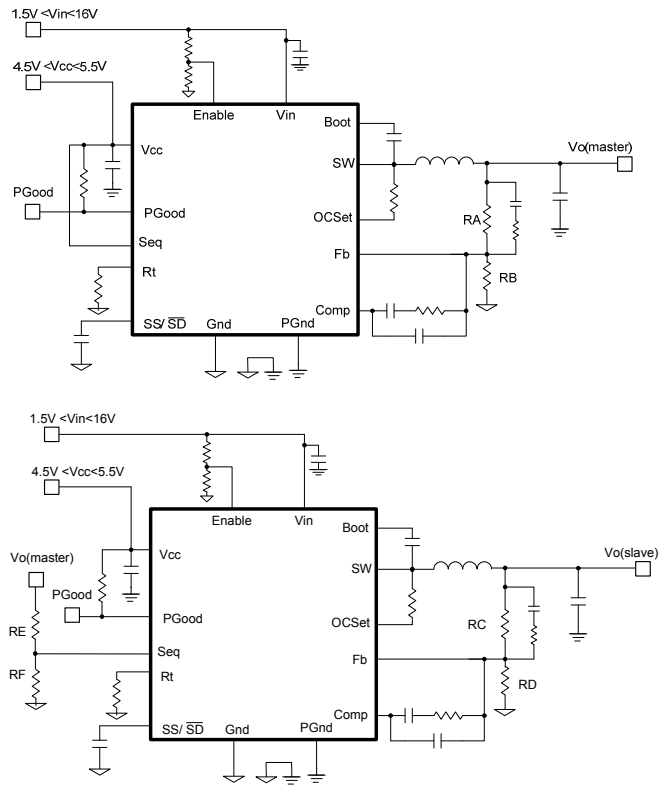

Fig. 8b. Application Circuit for Simultaneous Sequencing

### Power Good Output

The IC continually monitors the output voltage via Feedback (Fb pin). The feedback voltage forms an input to a window comparator whose upper and lower thresholds are 0.805V and 0.595V respectively. Hence, the Power Good signal is flagged when the Fb pin voltage is within the PGood window, i. e. between 0.595V to 0.805V, as shown in Fig. 9. The PGood pin is open drain and it needs to be externally pulled high. High state indicates that output is in regulation. Fig. 9a shows the PGood timing diagram for non-tracking operation. In this case, during startup, PGood goes high after the SS voltage reaches 2.1V if the Fb voltage is within the PGood comparator window. Fig. 9a. and Fig 9.b. also show a 256 cycle delay between the Fb voltage entering within the thresholds defined by the PGood window and PGood going high.



**TIMING DIAGRAM OF PGOOD FUNCTION**

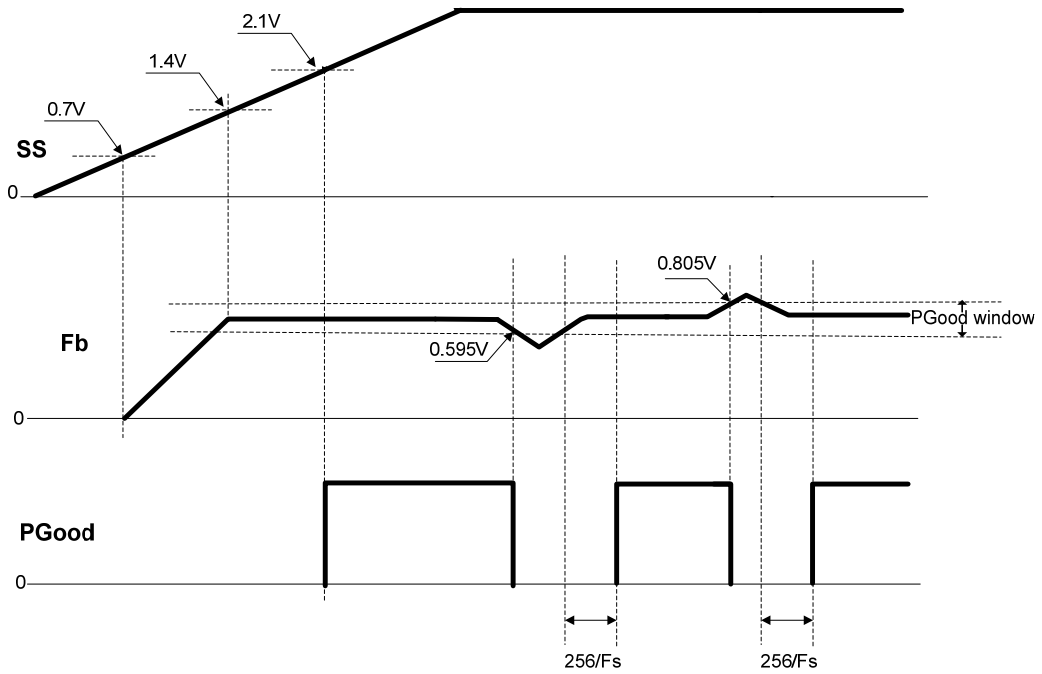

**Fig.9a IR3840A Non-Tracking Operation (Seq=Vcc)**

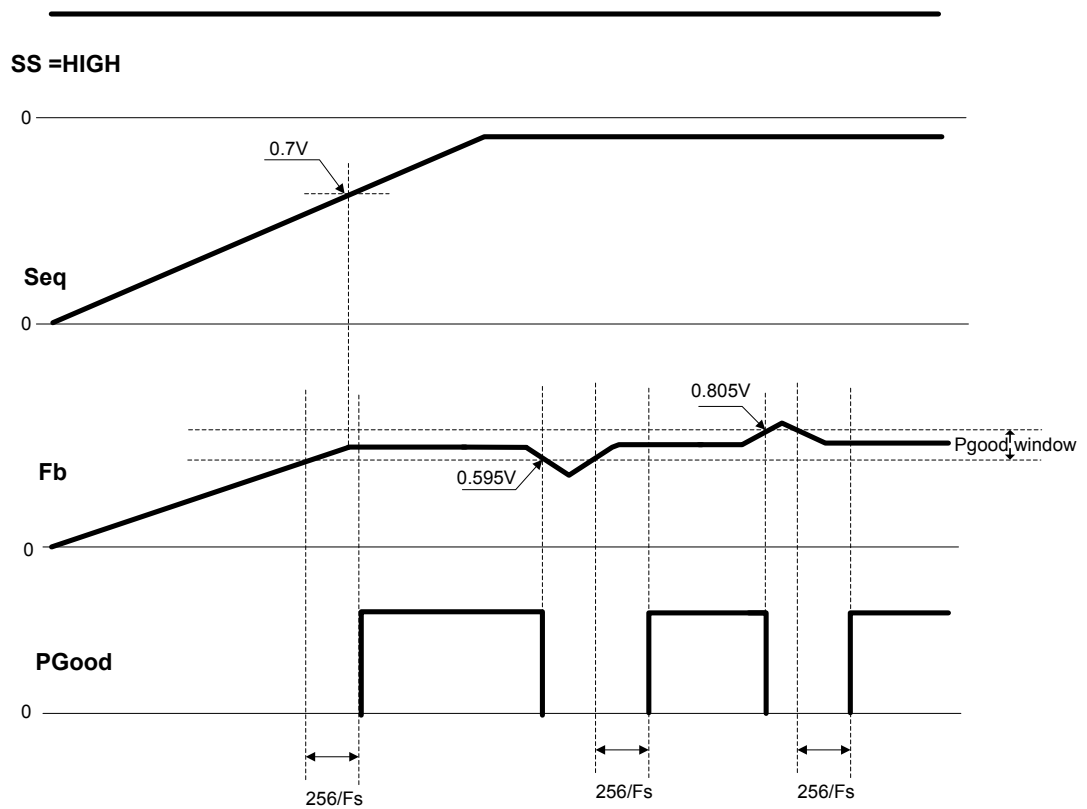

**Fig.9b IR3840A Tracking Operation**

### Minimum on time Considerations

The minimum ON time is the shortest amount of time for which the Control FET may be reliably turned on, and this depends on the internal timing delays. For the IR3840A, the typical minimum on-time is specified as 50 ns.

Any design or application using the IR3840A must ensure operation with a pulse width that is higher than this minimum on-time and preferably higher than 100 ns. This is necessary for the circuit to operate without jitter and pulse-skipping, which can cause high inductor current ripple and high output voltage ripple.

$$t_{on} = \frac{D}{F_s} = \frac{V_{out}}{V_{in} \times F_s}$$

In any application that uses the IR3840A, the following condition must be satisfied:

$$\begin{aligned} t_{on(min)} &\leq t_{on} \\ \therefore t_{on(min)} &\leq \frac{V_{out}}{V_{in} \times F_s} \\ \therefore V_{in} \times F_s &\leq \frac{V_{out}}{t_{on(min)}} \end{aligned}$$

The minimum output voltage is limited by the reference voltage and hence  $V_{out(min)} = 0.7 \text{ V}$ . Therefore, for  $V_{out(min)} = 0.7 \text{ V}$ ,

$$\begin{aligned} \therefore V_{in} \times F_s &\leq \frac{V_{out(min)}}{t_{on(min)}} \\ \therefore V_{in} \times F_s &\leq \frac{0.7 \text{ V}}{100 \text{ ns}} = 7 \times 10^6 \text{ V/s} \end{aligned}$$

Therefore, at the maximum recommended input voltage 16V and minimum output voltage, the converter should be designed at a switching frequency that does not exceed 440 kHz. Conversely, for operation at the maximum recommended operating frequency 1.65 MHz and minimum output voltage, any voltage above 4.2 V may not be stepped down without pulse-skipping.

### Maximum Duty Ratio Considerations

A fixed off-time of 200 ns maximum is specified for the IR3840A. This provides an upper limit on the operating duty ratio at any given switching frequency. It is clear, that higher the switching frequency, the lower is the maximum duty ratio at which the IR3840A can operate. To allow a margin of 50ns, the maximum operating duty ratio in any application using the IR3840A should still accommodate about 250 ns off-time. Fig 10. shows a plot of the maximum duty ratio v/s the switching frequency, with 250 ns off-time.

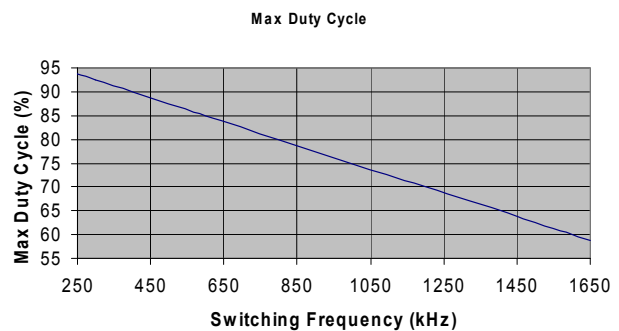

Fig. 10. Maximum duty cycle v/s switching frequency.

**Application Information**

**Design Example:**

The following example is a typical application for IR3840A. The application circuit is shown on page 23.

$$V_{in} = 12V (13.2V max)$$

$$V_o = 1.8V$$

$$I_o = 14A$$

$$\Delta V_o \leq 54mV$$

$$F_s = 600 kHz$$

**Enabling the IR3840A**

As explained earlier, the precise threshold of the Enable lends itself well to implementation of a UVLO for the Bus Voltage.

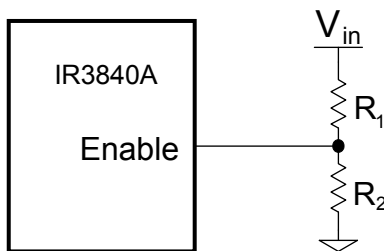

For a typical Enable threshold of  $V_{EN} = 1.2V$

$$V_{in(min)} * \frac{R_2}{R_1 + R_2} = V_{EN} = 1.2 \dots\dots\dots (5)$$

$$R_2 = R_1 \frac{V_{EN}}{V_{in(min)} - V_{EN}} \dots\dots\dots (6)$$

For a  $V_{in(min)} = 10.2V$ ,  $R_1 = 49.9K$  and  $R_2 = 7.5K$  is a good choice.

**Programming the frequency**

For  $F_s = 600 kHz$ , select  $R_t = 23.7 k\Omega$ , using Table. 1.

**Output Voltage Programming**

Output voltage is programmed by reference voltage and external voltage divider. The Fb pin is the inverting input of the error amplifier, which is internally referenced to 0.7V. The divider is ratioed to provide 0.7V at the Fb pin when the output is at its desired value. The output voltage is defined by using the following equation:

$$V_o = V_{ref} * \left(1 + \frac{R_8}{R_9}\right) \dots\dots\dots (7)$$

When an external resistor divider is connected to the output as shown in figure 11.

Equation (5) can be rewritten as:

$$R_9 = R_8 * \left(\frac{V_{ref}}{V_o - V_{ref}}\right) \dots\dots\dots (8)$$

For the calculated values of R8 and R9 see feedback compensation section.

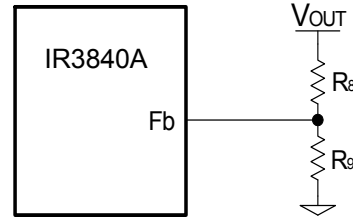

Fig. 11. Typical application of the IR3840A for programming the output voltage

**Soft-Start Programming**

The soft-start timing can be programmed by selecting the soft-start capacitance value. From (1), for a desired start-up time of the converter, the soft start capacitor can be calculated by using:

$$C_{SS} (\mu F) = T_{start} (ms) \times 0.02857 \dots\dots\dots (9)$$

Where  $T_{start}$  is the desired start-up time (ms).

For a start-up time of 3.5ms, the soft-start capacitor will be 0.099 $\mu F$ . Choose a 0.1 $\mu F$  ceramic capacitor.

**Bootstrap Capacitor Selection**

To drive the Control FET, it is necessary to supply a gate voltage at least 4V greater than the voltage at the SW pin, which is connected the source of the Control FET. This is achieved by using a bootstrap configuration, which comprises the internal bootstrap diode and an external bootstrap capacitor (C6) as shown in Fig. 12. The operation of the circuit is as follows: When the lower MOSFET is turned on, the capacitor node connected to SW is pulled down to ground. The capacitor charges towards  $V_{cc}$  through the internal bootstrap diode, which has a forward voltage drop  $V_D$ . The voltage  $V_c$  across the bootstrap capacitor C6 is approximately given as

$$V_c \cong V_{cc} - V_D \dots\dots\dots (10)$$

When the upper MOSFET turns on in the next cycle, the capacitor node connected to SW rises to the bus voltage  $V_{in}$ . However, if the value of C6 is appropriately chosen,

the voltage  $V_c$  across  $C_6$  remains approximately unchanged and the voltage at the Boot pin becomes

$$V_{Boot} \cong V_{in} + V_{cc} - V_D \dots\dots\dots (11)$$

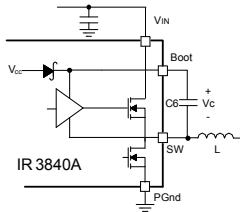

Fig. 12. Bootstrap circuit to generate  $V_c$  voltage

A bootstrap capacitor of value 0.1uF is suitable for most applications.

**Input Capacitor Selection**

The ripple current generated during the on time of the upper MOSFET should be provided by the input capacitor. The RMS value of this ripple is expressed by:

$$I_{RMS} = I_o * \sqrt{D*(1-D)} \dots\dots\dots (12)$$

$$D = \frac{V_o}{V_{in}} \dots\dots\dots (13)$$

Where:

$D$  is the Duty Cycle

$I_{RMS}$  is the RMS value of the input capacitor current.

$I_o$  is the output current.

For  $I_o=14A$  and  $D = 0.15$ , the  $I_{RMS} = 5A$ .

Ceramic capacitors are recommended due to their peak current capabilities. They also feature low ESR and ESL at higher frequency which enables better efficiency. For this application, it is advisable to have 4x10uF 16V ceramic capacitors ECJ-3YB1C106M from Panasonic. In addition to these, although not mandatory, a 1X330uF, 25V SMD capacitor EEV-FK1E331P may also be used as a bulk capacitor and is recommended if the input power supply is not located close to the converter.

**Inductor Selection**

The inductor is selected based on output power, operating frequency and efficiency requirements. A low inductor value causes large ripple current, resulting in the smaller size, faster response to a load transient but poor efficiency and high output noise. Generally, the selection of the inductor value can be reduced to the desired maximum ripple current in the inductor ( $\Delta i$ ). The optimum point is usually found between 20% and 50% ripple of the output current.

For the buck converter, the inductor value for the desired operating ripple current can be determined using the following relation:

$$V_{in} - V_o = L * \frac{\Delta i}{\Delta t}; \Delta t = D * \frac{1}{F_s} \dots\dots\dots (14)$$

$$L = (V_{in} - V_o) * \frac{V_o}{V_{in} * \Delta i * F_s}$$

Where:

$V_{in}$  = Maximum input voltage

$V_o$  = Output Voltage

$\Delta i$  = Inductor ripple current

$F_s$  = Switching frequency

$\Delta t$  = Turn on time

$D$  = Duty cycle

If  $\Delta i \approx 33\%(I_o)$ , then the output inductor is calculated to be 0.55uH. Select  $L=0.56 \mu H$ .

The MPC1040LR56C from Delta provides a compact, low profile inductor suitable for this application.

**Output Capacitor Selection**

The voltage ripple and transient requirements determine the output capacitors type and values. The criteria is normally based on the value of the Effective Series Resistance (ESR). However the actual capacitance value and the Equivalent Series Inductance (ESL) are other contributing components. These components can be described as

$$\Delta V_o = \Delta V_{o(ESR)} + \Delta V_{o(ESL)} + \Delta V_{o(C)} \dots\dots\dots (15)$$

$$\Delta V_{o(ESR)} = \Delta I_L * ESR$$

$$\Delta V_{o(ESL)} = \left( \frac{V_m - V_o}{L} \right) * ESL$$

$$\Delta V_{o(C)} = \frac{\Delta I_L}{8 * C_o * F_s} \dots\dots\dots (15)$$

$\Delta V_o$  = Output voltage ripple  
 $\Delta I_L$  = Inductor ripple current

Since the output capacitor has a major role in the overall performance of the converter and determines the result of transient response, selection of the capacitor is critical. The IR3840A can perform well with all types of capacitors.

As a rule, the capacitor must have low enough ESR to meet output ripple and load transient requirements.

The goal for this design is to meet the voltage ripple requirement in the smallest possible capacitor size. Therefore it is advisable to select ceramic capacitors due to their low ESR and ESL and small size. Eight of the Panasonic ECJ-2FB0J226ML (22uF, 6.3V, 3mOhm) capacitors is a good choice.

**Feedback Compensation**

The IR3840A is a voltage mode controller. The control loop is a single voltage feedback path including error amplifier and error comparator. To achieve fast transient response and accurate output regulation, a compensation circuit is necessary. The goal of the compensation network is to provide a closed-loop transfer function with the highest 0 dB crossing frequency and adequate phase margin (greater than 45°).

The output LC filter introduces a double pole, -40dB/decade gain slope above its corner resonant frequency, and a total phase lag of 180° (see figure 13). The resonant frequency of the LC filter is expressed as follows:

$$F_{LC} = \frac{1}{2 * \pi * \sqrt{L_o * C_o}} \dots\dots\dots (16)$$

Figure 13 shows gain and phase of the LC filter. Since we already have 180° phase shift from the output filter alone, the system runs the risk of being unstable.

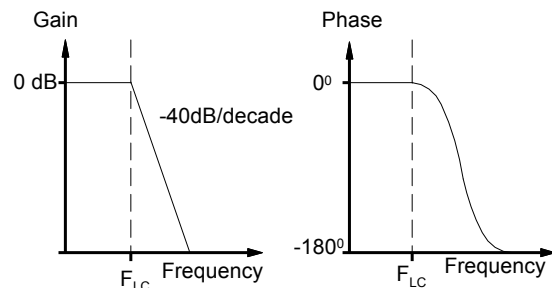

Fig. 13. Gain and Phase of LC filter

The IR3840A uses a voltage-type error amplifier with high-gain (110dB) and wide-bandwidth. The output of the amplifier is available for DC gain control and AC phase compensation.

The error amplifier can be compensated either in type II or type III compensation.

Local feedback with Type II compensation is shown in Fig. 14.

This method requires that the output capacitor should have enough ESR to generate a zero typically at 5kHz to 50kHz, which is essential for an acceptable phase margin and to satisfy stability requirements.

$$F_{ESR} = \frac{1}{2 * \pi * ESR * C_o} \dots\dots\dots (17)$$

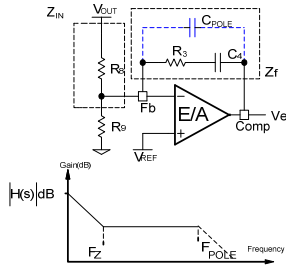

Fig. 14. Type II compensation network and its asymptotic gain plot

The transfer function ( $V_e/V_o$ ) is given by:

$$\frac{V_e}{V_o} = H(s) = -\frac{Z_f}{Z_{IN}} = -\frac{1+sR_3C_4}{sR_8C_4} \dots(18)$$

The (s) indicates that the transfer function varies as a function of frequency. This configuration introduces a gain and zero, expressed by:

$$|H(s)| = \frac{R_3}{R_8} \dots(19)$$

$$F_z = \frac{1}{2\pi * R_3 * C_4} \dots(20)$$

First select the desired zero-crossover frequency ( $F_o$ ):

$$F_o > F_{ESR} \text{ and } F_o \leq (1/5 \sim 1/10) * F_s$$

Use the following equation to calculate R3:

$$R_3 = \frac{V_{osc} * F_o * F_{ESR} * R_8}{V_{in} * F_{LC}^2} \dots(21)$$

Where:

- $V_{in}$  = Maximum Input Voltage
- $V_{osc}$  = Oscillator Ramp Voltage
- $F_o$  = Crossover Frequency
- $F_{ESR}$  = Zero Frequency of the Output Capacitor
- $F_{LC}$  = Resonant Frequency of the Output Filter
- $R_8$  = Feedback Resistor

To cancel one of the LC filter poles, place the zero before the LC filter resonant frequency pole:

$$F_z = 75\% F_{LC}$$

$$F_z = 0.75 * \frac{1}{2\pi * \sqrt{L_o} * C_o} \dots(22)$$

Use equations (20), (21) and (22) to calculate C4.

One more capacitor is sometimes added in parallel with C4 and R3. This introduces one more pole which is mainly used to suppress the switching noise.

The additional pole is given by:

$$F_p = \frac{1}{2\pi * R_3 * \frac{C_4 * C_{POLE}}{C_4 + C_{POLE}}} \dots(23)$$

The pole sets to one half of the switching frequency which results in the capacitor  $C_{POLE}$ :

$$C_{POLE} = \frac{1}{\pi * R_3 * F_s - \frac{1}{C_4}} \cong \frac{1}{\pi * R_3 * F_s} \dots(24)$$

For a general solution for unconditional stability for any type of output capacitors, and a wide range of ESR values, we should implement local feedback with a type III compensation network. The typically used compensation network for voltage-mode controller is shown in figure 15.

Again, the transfer function is given by:

$$\frac{V_e}{V_o} = H(s) = -\frac{Z_f}{Z_{IN}}$$

By replacing  $Z_{in}$  and  $Z_f$  according to figure 15, the transfer function can be expressed as:

$$H(s) = -\frac{(1+sR_3C_4)[1+sC_7(R_8+R_{10})]}{sR_8(C_4+C_3)\left[1+sR_3\left(\frac{C_4 * C_3}{C_4+C_3}\right)\right](1+sR_{10}C_7)} \dots(25)$$

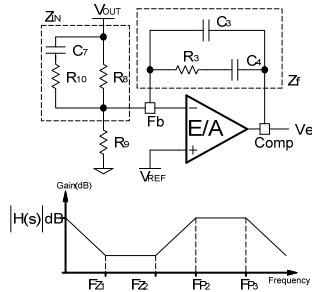

Fig.15. Type III Compensation network and its asymptotic gain plot

The compensation network has three poles and two zeros and they are expressed as follows:

$$F_{P1} = 0 \dots\dots\dots(26)$$

$$F_{P2} = \frac{1}{2\pi * R_{10} * C_7} \dots\dots\dots(27)$$

$$F_{P3} = \frac{1}{2\pi * R_3 * \left( \frac{C_4 * C_3}{C_4 + C_3} \right)} \cong \frac{1}{2\pi * R_3 * C_3} \dots\dots\dots(28)$$

$$F_{Z1} = \frac{1}{2\pi * R_3 * C_4} \dots\dots\dots(29)$$

$$F_{Z2} = \frac{1}{2\pi * C_7 * (R_8 + R_{10})} \cong \frac{1}{2\pi * C_7 * R_8} \dots\dots\dots(30)$$

Cross over frequency is expressed as:

$$F_o = R_3 * C_7 * \frac{V_{in}}{V_{osc}} * \frac{1}{2\pi * L_o * C_o} \dots\dots\dots(31)$$

Based on the frequency of the zero generated by the output capacitor and its ESR, relative to crossover frequency, the compensation type can be different. The table below shows the compensation types and location of the crossover frequency.

Compensator Type	$F_{ESR}$ vs $F_o$	Output Capacitor
Type II	$F_{LC} < F_{ESR} < F_o < F_s/2$	Electrolytic Tantalum
Type III	$F_{LC} < F_o < F_{ESR}$	Tantalum Ceramic

The higher the crossover frequency, the potentially faster the load transient response. However, the crossover frequency should be low enough to allow attenuation of switching noise. Typically, the control loop bandwidth or crossover frequency is selected such that

$$F_o \leq (1/5 \sim 1/10) * F_s$$

The DC gain should be large enough to provide high DC-regulation accuracy. The phase margin should be greater than 45° for overall stability.

For this design we have:

- $V_{in} = 12V$
- $V_o = 1.8V$
- $V_{osc} = 1.8V$
- $V_{ref} = 0.7V$
- $L_o = 0.56\mu H$
- $C_o = 8x22\mu F$ , ESR=1.3mOhm each

It must be noted here that the value of the capacitance used in the compensator design must be the small signal value. For instance, the small signal capacitance of the 22uF capacitor used in this design is 12uF at 1.8 V DC bias and 600 kHz frequency. It is this value that must be used for all computations related to the compensation. The small signal value may be obtained from the manufacturer's datasheets, design tools or SPICE models. Alternatively, they may also be inferred from measuring the power stage transfer function of the converter and measuring the double pole frequency  $F_{LC}$  and using equation (16) to compute the small signal  $C_o$ .

These result to:

- $F_{LC} = 21.71$  kHz**
- $F_{ESR} = 4.4$  MHz**
- $F_s/2 = 300$  kHz**

Select crossover frequency:  **$F_o = 100$  kHz**

Since  $F_{LC} < F_o < F_s/2 < F_{ESR}$ , TypeIII is selected to place the pole and zeros.

Detailed calculation of compensation TypeIII

Desired Phase Margin  $\Theta=70^\circ$

$$F_{Z2} = F_o \sqrt{\frac{1 - \sin \Theta}{1 + \sin \Theta}} = 17.63 \text{ kHz}$$

$$F_{P2} = F_o \sqrt{\frac{1 + \sin \Theta}{1 - \sin \Theta}} = 567.1 \text{ kHz}$$

Select  $F_{Z1} = 0.5 * F_{Z2} = 8.82 \text{ kHz}$  and

$$F_{P3} = 0.5 * F_s = 300 \text{ kHz}$$

Select  $C_7 = 2.2 \text{ nF}$

Calculate  $R_3$ ,  $C_3$  and  $C_4$  :

$$R_3 = \frac{2\pi * F_o * L_o * C_o * V_{osc}}{C_7 * V_{in}}; R_3 = 2.30 \text{ k}\Omega$$

Select  $R_3 = 2.32 \text{ k}\Omega$

$$C_4 = \frac{1}{2\pi * F_{Z1} * R_3}; C_4 = 7.8 \text{ nF, Select } C_4 = 8.2 \text{ nF}$$

$$C_3 = \frac{1}{2\pi * F_{P3} * R_3}; C_3 = 230.6 \text{ pF, Select } C_3 = 220 \text{ pF}$$

Calculate  $R_{10}$ ,  $R_8$  and  $R_9$  :

$$R_{10} = \frac{1}{2\pi * C_7 * F_{P2}}; R_{10} = 128 \Omega, \text{ Select } R_{10} = 130 \Omega$$

$$R_8 = \frac{1}{2\pi * C_7 * F_{Z2}} - R_{10}; R_8 = 3.97 \text{ k}\Omega,$$

Select  $R_8 = 4.02 \text{ k}\Omega$

$$R_9 = \frac{V_{ref}}{V_o - V_{ref}} * R_8; R_9 = 2.56 \text{ k}\Omega \text{ Select } R_9 = 2.55 \text{ k}\Omega$$

### Programming the Current-Limit

The Current-Limit threshold can be set by connecting a resistor ( $R_{OCSET}$ ) from the SW pin to the OCSet pin. The resistor can be calculated by using equation (4). This resistor ROCSET must be placed close to the IC.

The  $R_{DS(on)}$  has a positive temperature coefficient and it should be considered for the worst case operation.

$$I_{SET} = I_{L(critical)} = \frac{R_{OCSet} * I_{OCSet}}{R_{DS(on)}} \dots\dots\dots(32)$$

$$R_{DS(on)} = 5.7 \text{ m}\Omega * 1.25 = 7.125 \text{ m}\Omega$$

$$I_{SET} \cong I_{o(LIM)} = 14 \text{ A} * 1.5 = 21 \text{ A}$$

(50% over nominal output current )

$$I_{OCSet} = 59.07 \mu\text{A (at } F_s = 600 \text{ kHz)}$$

$$R_{OCSet} = 2.53 \text{ k}\Omega \text{ Select } R_7 = 2.55 \text{ k}\Omega$$

### Setting the Power Good Threshold

A window comparator internally sets a lower Power Good threshold at 0.6V and an upper Power Good threshold at 0.8V. When the voltage at the FB pin is within the window set by these thresholds, PGood is asserted.

The PGood is an open drain output. Hence, it is necessary to use a pull up resistor  $R_{PG}$  from PGood pin to Vcc. The value of the pull-up resistor must be chosen such as to limit the current flowing into the PGood pin, when the output voltage is not in regulation, to less than 5 mA. A typical value used is 10k $\Omega$ .





**TYPICAL OPERATING WAVEFORMS**

**Vin=12.0V, Vcc=5V, Vo=1.8V, Io=0-14A, Room Temperature, No Air Flow**

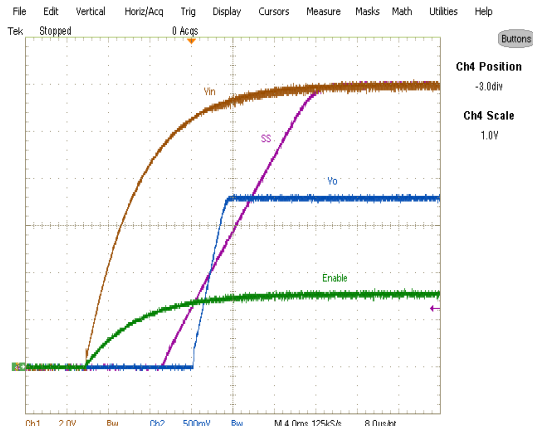

Fig. 17: Start up at 14A Load  
Ch<sub>1</sub>:V<sub>in</sub>, Ch<sub>2</sub>:V<sub>o</sub>, Ch<sub>3</sub>:V<sub>SS</sub>, Ch<sub>4</sub>:Enable

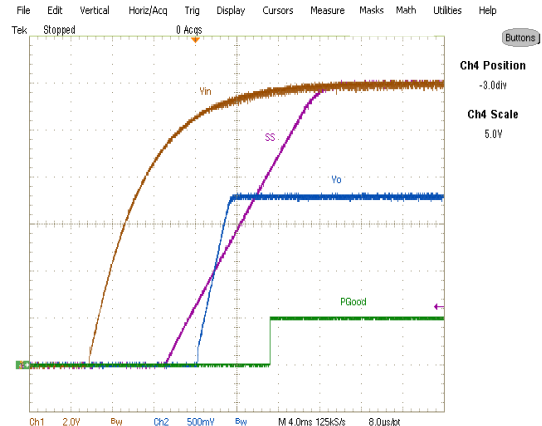

Fig. 18: Start up at 14A Load,  
Ch<sub>1</sub>:V<sub>in</sub>, Ch<sub>2</sub>:V<sub>o</sub>, Ch<sub>3</sub>:V<sub>SS</sub>, Ch<sub>4</sub>:V<sub>PGGood</sub>

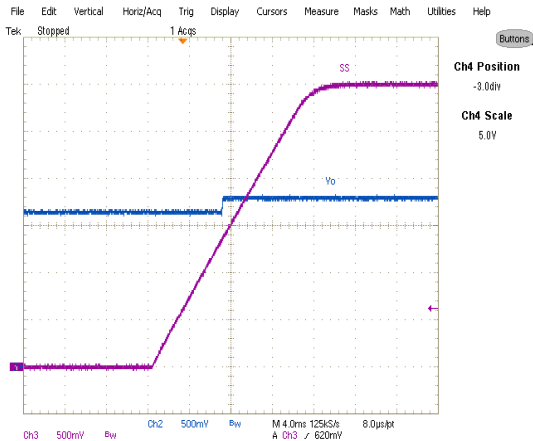

Fig. 19: Start up with 1.62V Pre Bias, 0A Load, Ch<sub>2</sub>:V<sub>o</sub>, Ch<sub>3</sub>:V<sub>SS</sub>

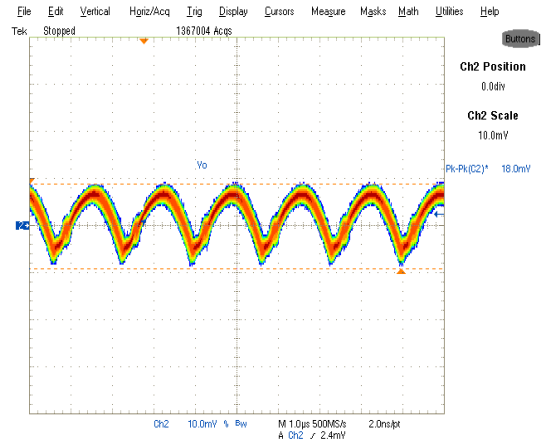

Fig. 20: Output Voltage Ripple, 14A load Ch<sub>2</sub>: V<sub>out</sub>

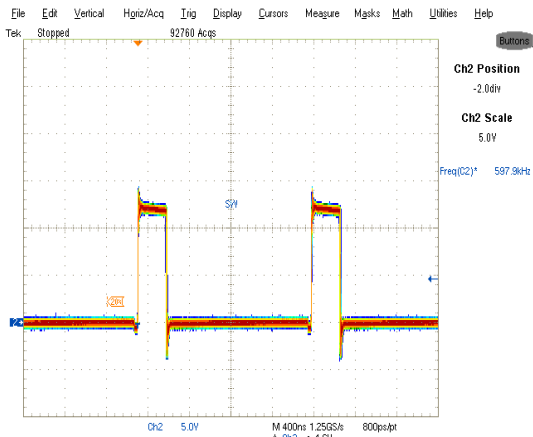

Fig. 21: Inductor node at 14A load  
Ch<sub>2</sub>:LX

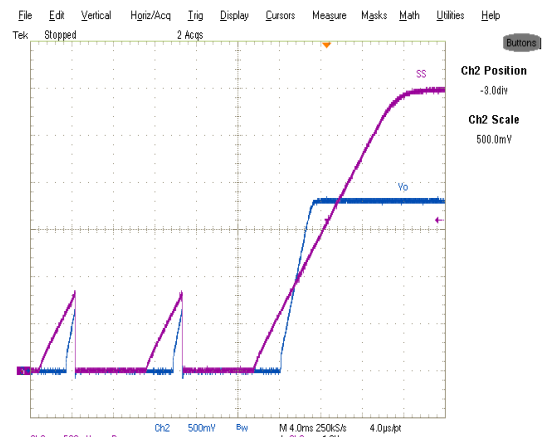

Fig. 22: Short (Hiccup) Recovery  
Ch<sub>2</sub>:V<sub>out</sub>, Ch<sub>3</sub>:V<sub>SS</sub>