



Chipsmall Limited consists of a professional team with an average of over 10 year of expertise in the distribution of electronic components. Based in Hongkong, we have already established firm and mutual-benefit business relationships with customers from,Europe,America and south Asia,supplying obsolete and hard-to-find components to meet their specific needs.

With the principle of “Quality Parts,Customers Priority,Honest Operation,and Considerate Service”,our business mainly focus on the distribution of electronic components. Line cards we deal with include Microchip,ALPS,ROHM,Xilinx,Pulse,ON,Everlight and Freescale. Main products comprise IC,Modules,Potentiometer,IC Socket,Relay,Connector.Our parts cover such applications as commercial,industrial, and automotives areas.

We are looking forward to setting up business relationship with you and hope to provide you with the best service and solution. Let us make a better world for our industry!



Contact us

Tel: +86-755-8981 8866 Fax: +86-755-8427 6832

Email & Skype: info@chipsmall.com Web: www.chipsmall.com

Address: A1208, Overseas Decoration Building, #122 Zhenhua RD., Futian, Shenzhen, China



Sup/IRBuck™

USER GUIDE FOR iP1827 EVALUATION BOARD

DESCRIPTION

The iP1827 is a synchronous buck converter, providing a compact, high performance and flexible solution in a small 7.7mm X 7.7 mm LGA package.

Key features offered by the iP1827 include programmable soft-start ramp, precision 0.6V reference voltage, Power Good, thermal protection, programmable switching frequency, Enable input, input under-voltage lockout for proper start-up, and pre-bias start-up.

An output over-current protection function is implemented by sensing the voltage developed across the on-resistance of the synchronous rectifier MOSFET for optimum cost and performance.

This user guide contains the schematic and bill of materials for the iP1827 evaluation board. The guide describes operation and use of the evaluation board itself. Detailed application information for iP1827 is available in the iP1827 data sheet.

BOARD FEATURES

- $V_{in} = +12V (+ 13.2V \text{ Max})$
- $V_{cc} = +3.3V (3.46V \text{ Max})$
- $V_{out} = +1.8V @ 0- 25A$
- $F_s = 600kHz$
- $L = 0.3\mu H$
- $C_{in} = 5 \times 22\mu F (\text{ceramic } 1206) + 1 \times 330\mu F (\text{electrolytic})$
- $C_{out} = 10 \times 22\mu F (\text{ceramic } 0805)$

CONNECTIONS and OPERATING INSTRUCTIONS

A well regulated +12V input supply should be connected to VIN+ and VIN-. A maximum 25A load should be connected to VOUT+ and VOUT-. The inputs and outputs of the board are listed in Table I.

iP1827 has two input supplies, one for biasing (Vcc) and the other as input voltage (Vin). Separate supplies should be applied to these inputs. Vcc input should be a well regulated 3.13V-3.46V supply and it would be connected to Vcc+ and Vcc-.

External Enable signal can be applied to the board via exposed Enable pad and *R18 should be removed for this purpose. For proper operation of iP1827, the voltage at Enable should always be kept below Vcc.*

Table I. Connections

Connection	Signal Name
VIN+	V_{in} (+12V)
VIN-	Ground of V_{in}
Vcc+	Vcc input
Vcc-	Ground for Vcc input
VOUT-	Ground of V_{out}
VOUT+	V_{out} (+1.8V)
Enable	Enable
P_Good	Power Good Signal

LAYOUT

The PCB is a 6-layer board. All of layers are 2 Oz. copper. The iP1827 and most of the passive components are mounted on the top side of the board.

Power supply decoupling capacitors and feedback components are located close to iP1827. The feedback resistors are connected to the output of the remote sense amplifier of the iP1827 and are located close to the iP1827. To improve efficiency, the circuit board is designed to minimize the length of the on-board power ground current path. Separate power ground and analog ground are used and may be connected together using a 0 ohm resistor at one of two possible locations

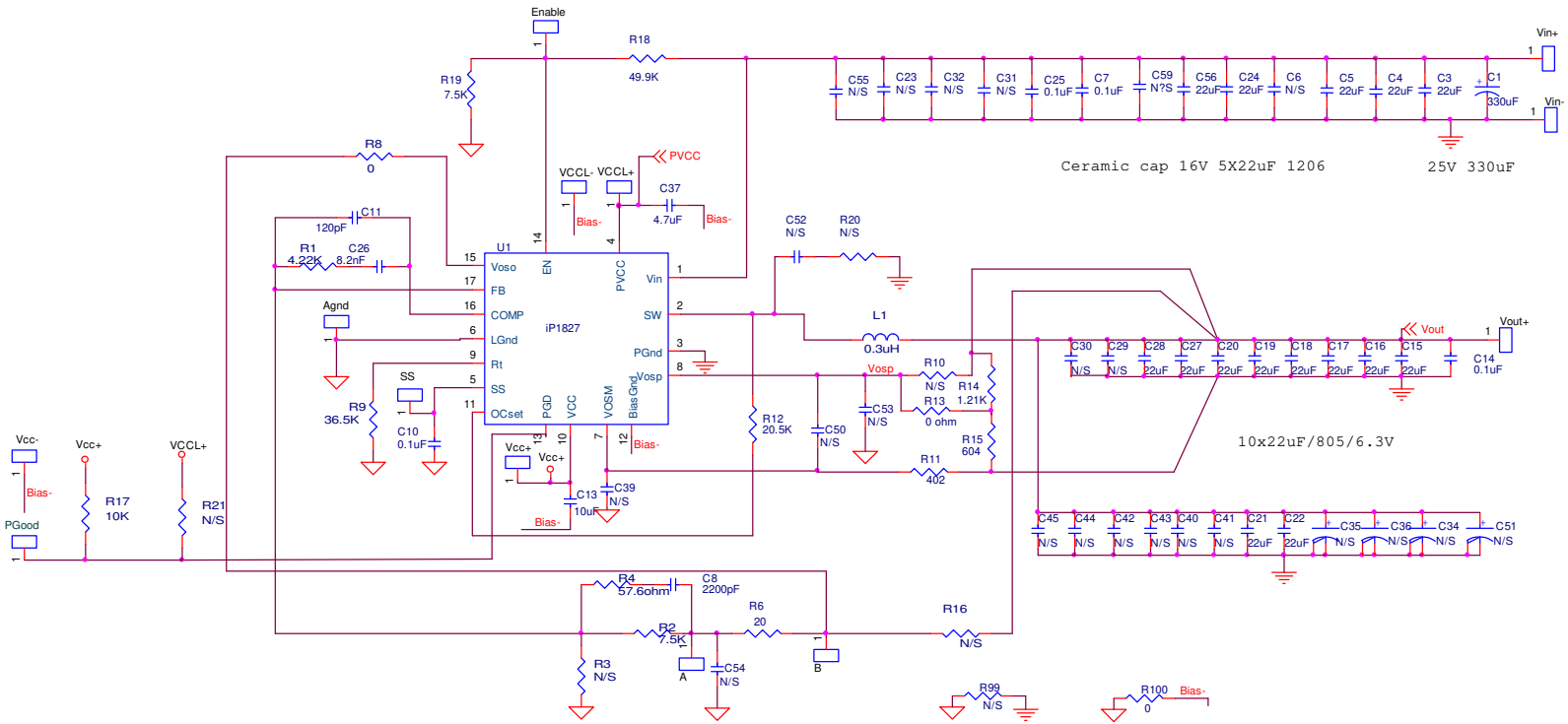

Single point of connection between Power Ground and Signal ("analog") Ground

Fig. 1: Schematic of the iP1827 evaluation board

Bill of Materials

Item	Quantity	Part Reference	Value	Description	Manufacturer	Part Number
1	5	C3 C4 C5 C24 C56	22uF	22uF,1206,16V, X5R, 20%	TDK	C3216X5R1C226M
2	1	C1	330uF	SMD Electrolytic, Fsize, 25V, 20%	Panasonic	EEV-FK1E331P
3	4	C7 C14 C25 C10	0.1uF	0603, 25V, X7R, 10%	Panasonic	ECJ-1VB1E104K
4	1	C8	2200pF	2200pF,0603,50V,X7R	Panasonic	ECJ-1VB1H222K
5	1	C11	120pF	50V, 0603, NP0, 5%	Murata	GRM1885C1H121JA01D
6	10	C15 C16 C17 C18 C19 C20 C21 C22 C27 C28	22uF	0805, 6.3V, X5R, 20%	Panasonic	ECJ-2FB0J226M
7	1	C37	4.7uF	0805, 10V, X5R	TDK	C2012X5R1A475K
8	1	C26	8200pF	0603, 50V, X7R, 10%	Panasonic	ECJ-1VB1H822K
9	1	L1	0.3uH	0.3uH, DCR=0.29mohm	Vitec	59PR9874N
10	1	R1	4.22K	0603,1/10W,1%	Rohm	MCR03EZPFX4221
11	1	R2	7.5k	0603,1/10W,1%	Rohm	MCR03EZPFX7501
12	1	R4	57.6	0603,1/10W,1%	Vishay/Dale	CRCW060357R6FKEA
13	1	R6	20	20,0603,1/10 W,1%	Vishay/Dale	CRCW060320R0FKEA
14	1	R9	36.5K	0603,1/10W,1%	Rohm	MCR03EZPFX3652
15	3	R8 R100 R13	0	0,0603,1/10 W,5%	Vishay/Dale	CRCW06030000Z0EA
16	1	C13	10uF	0603, X5R, 6.3V	TDK	C1608X5R0J106M
17	1	R12	20K	0603,1/10 W,1%	Rohm	MCR03EZPFX2002
18	1	R14	1.21K	0603,1/10 W,1%	Rohm	MCR03EZPFX1211
19	1	R15	604	0603,1/10 W,1%	Rohm	MCR03EZPFX6040
20	1	R11	402	0603,1/10 W,1%	Rohm	MCR03EZPFX4020
21	1	R18	49.9K	49.9K,0603,1/10 W,1%	Rohm	MCR03EZPFX4992
22	1	R19	7.5K	7.5K,0603,1/10W,1%	Rohm	MCR03EZPFX7501
23	1	R17	10K	0603,1/10 W,1%	Rohm	MCR03EZPFX1002
24	1	U1	iP1827	iP1827 7.7mmX7.7mm	International Rectifier	iP1827PbF

TYPICAL OPERATING WAVEFORMS

Vin=12.0V, Vcc=3.3V, Vo=1.8V, Io=0A-25A, Room Temperature, no airflow

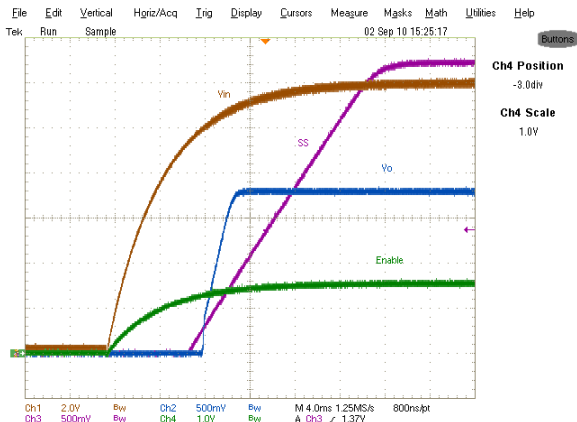

Fig. 2: Start up at 25A Load
Ch₁:V_{in}, Ch₂:V_o, Ch₃:V_{ss}, Ch₄:Enable

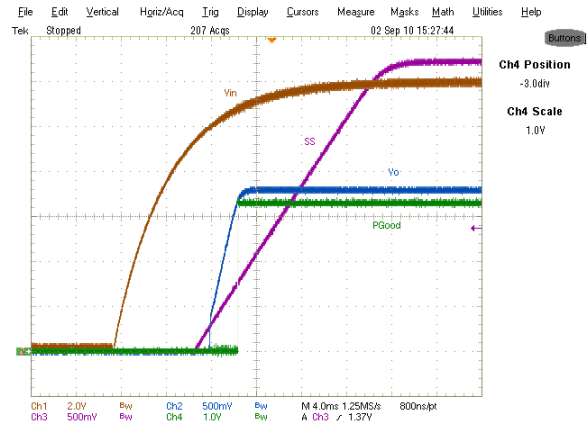

Fig. 3: Start up at 25A Load,
Ch₁:V_{in}, Ch₂:V_o, Ch₃:V_{ss}, Ch₄:V_{PGGood}

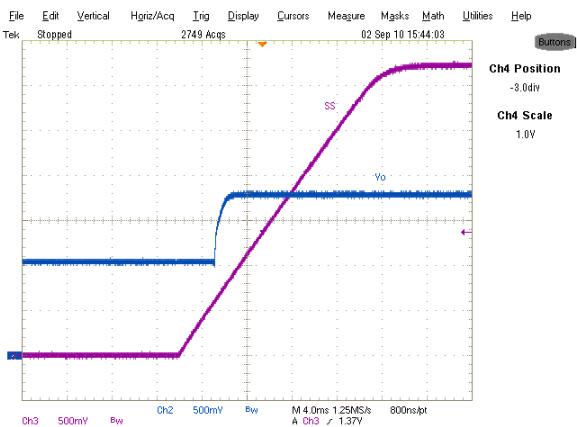

Fig. 4: Start up with 1V Pre Bias, 0A Load, Ch₂:V_o, Ch₃:V_{ss}

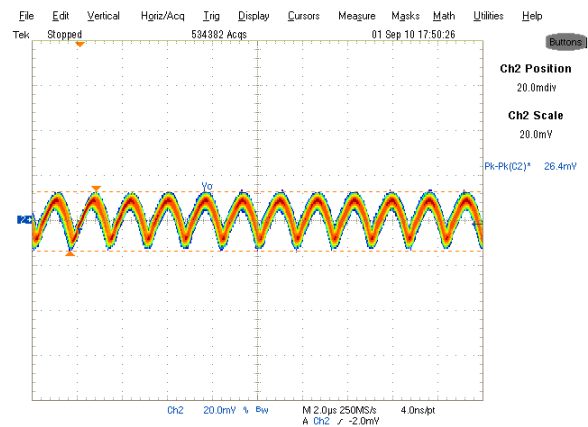

Fig. 5: Output Voltage Ripple, 25A load
Ch₂: V_{out}

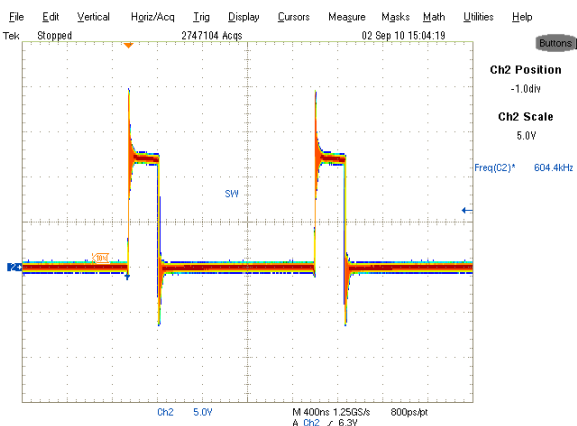

Fig. 6: Inductor node at 25A load
Ch₂:LX

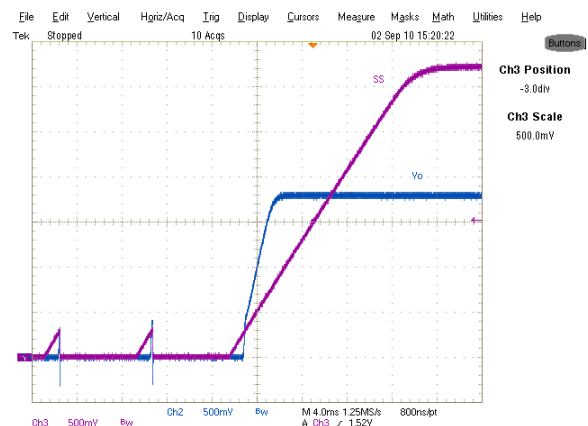

Fig. 7: Short (Hiccup) Recovery
Ch₂:V_{out}, Ch₃:V_{ss}

TYPICAL OPERATING WAVEFORMS

$V_{in}=12.0V$, $V_{cc}=3.3V$, $V_o=1.8V$, $I_o=2.5A-10A$, Room Temperature, no air flow

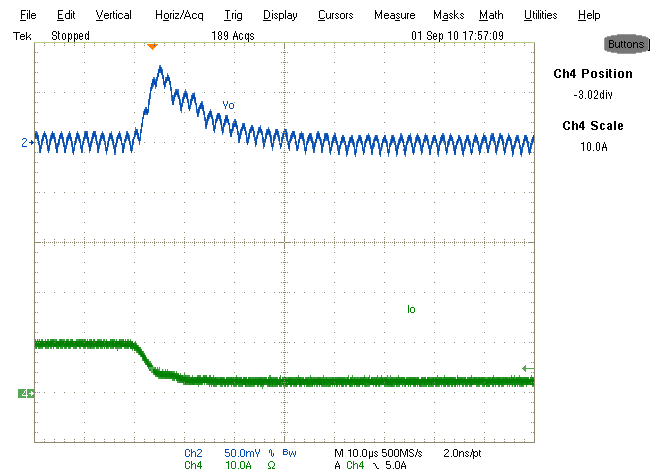
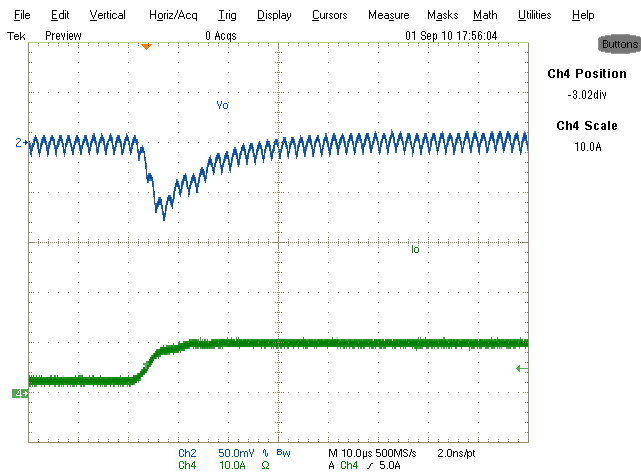
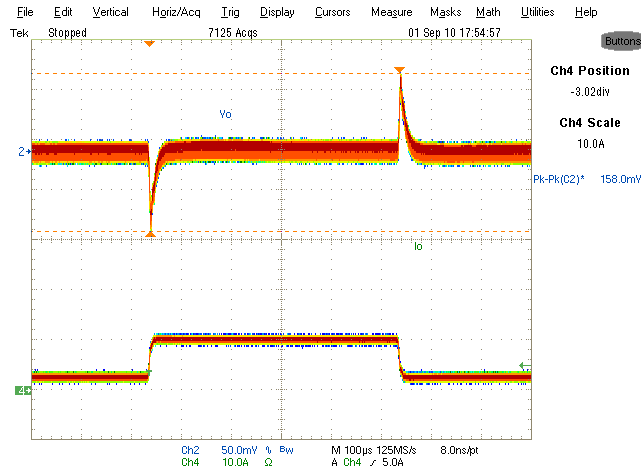

Fig. 8: Transient Response, 2.5A to 10A step (2.5A/us)
 $Ch_2: V_{out}$, $Ch_4: I_o$

TYPICAL OPERATING WAVEFORMS

$V_{in}=12.0V$, $V_{cc}=3.3V$, $V_o=1.8V$, $I_o=17.5A-25A$, Room Temperature, no air flow

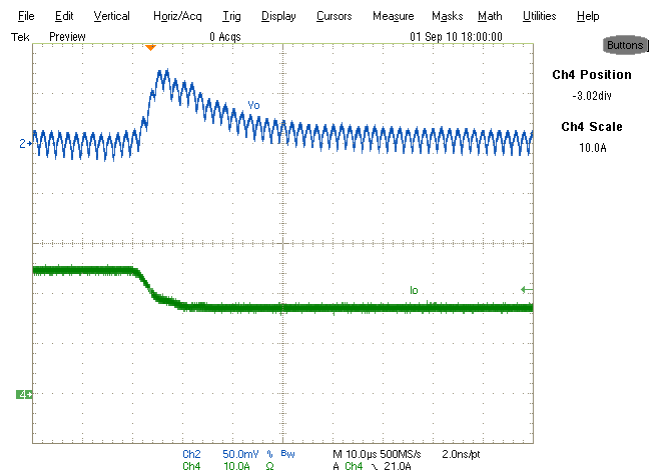
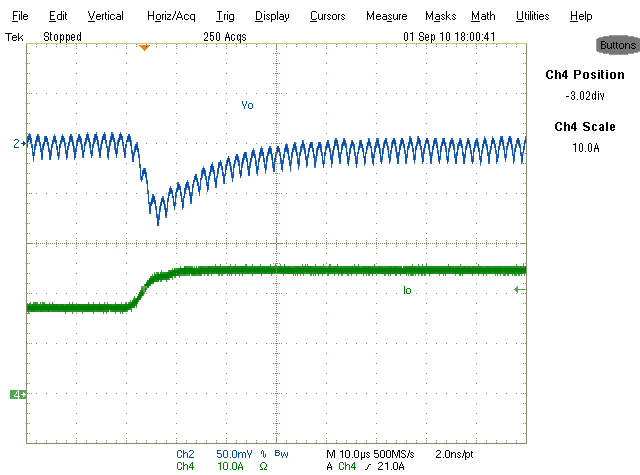
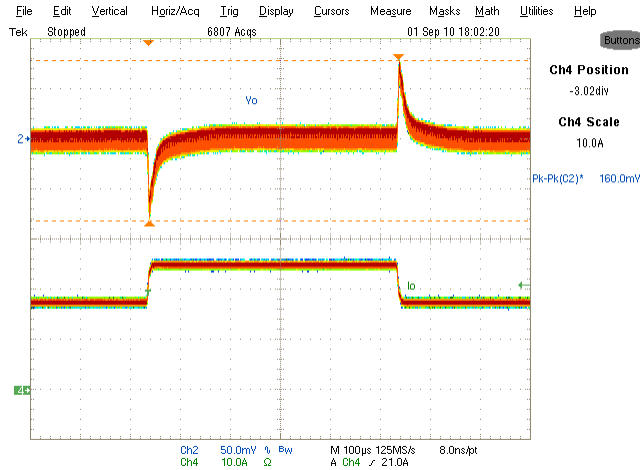

Fig. 9: Transient Response, 17.5A to 25A step (2.5A/µs)
 $Ch_2: V_{out}$, $Ch_4: I_o$

TYPICAL OPERATING WAVEFORMS
Vin=12.0V, Vcc=3.3V, Vo=1.8V, Io=0A-25A, Room Temperature

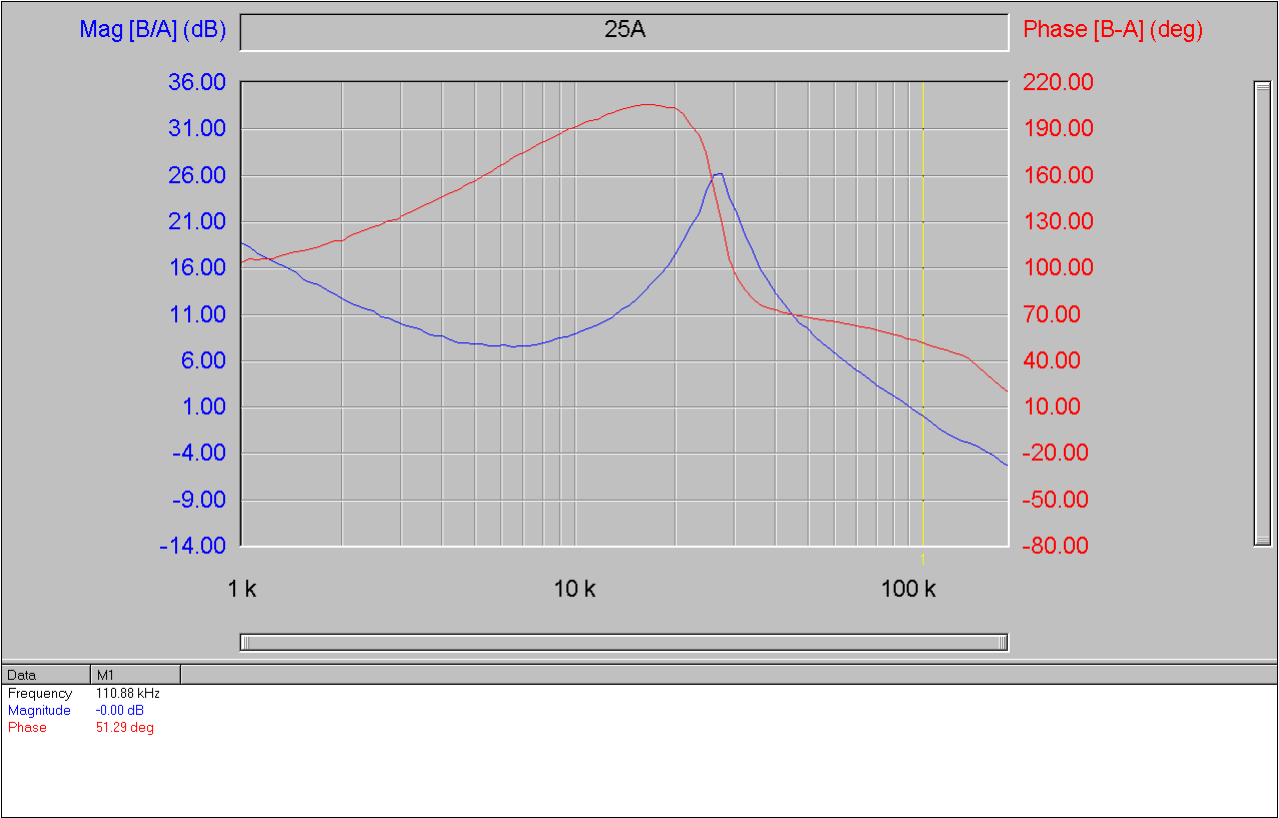

Fig. 10: Bode Plot at 25A load shows a bandwidth of 110.88kHz and phase margin of 51.29 degrees

TYPICAL OPERATING WAVEFORMS

$V_{in}=12.0V$, $V_{cc}=3.3V$, $V_o=1.8V$, $I_o=0A-25A$, Room Temperature, no air flow

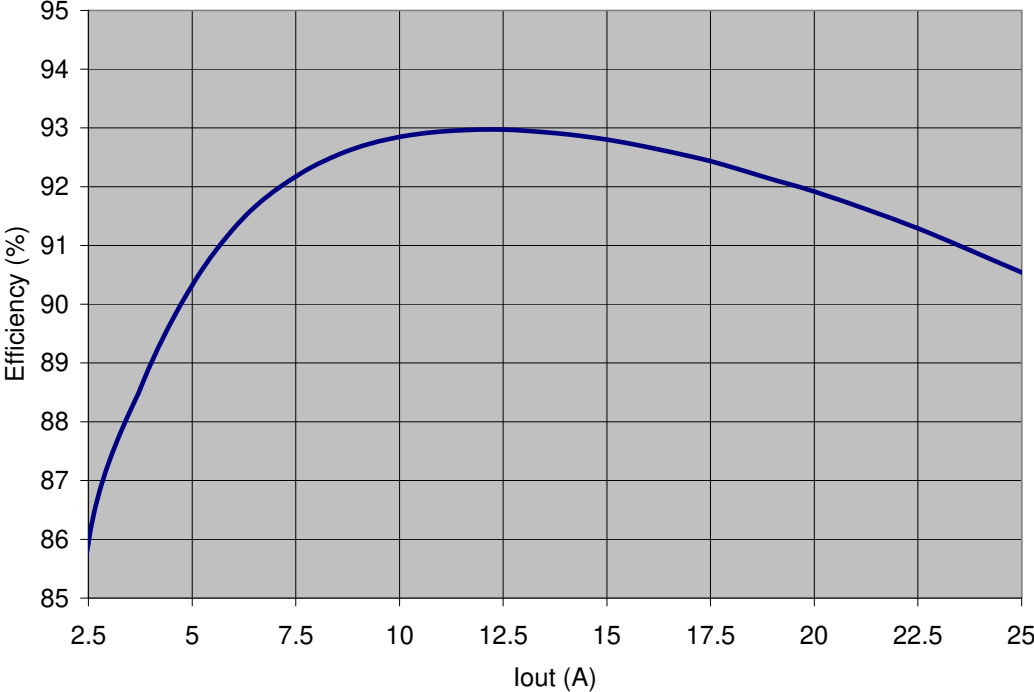

Fig.11: Efficiency versus load current

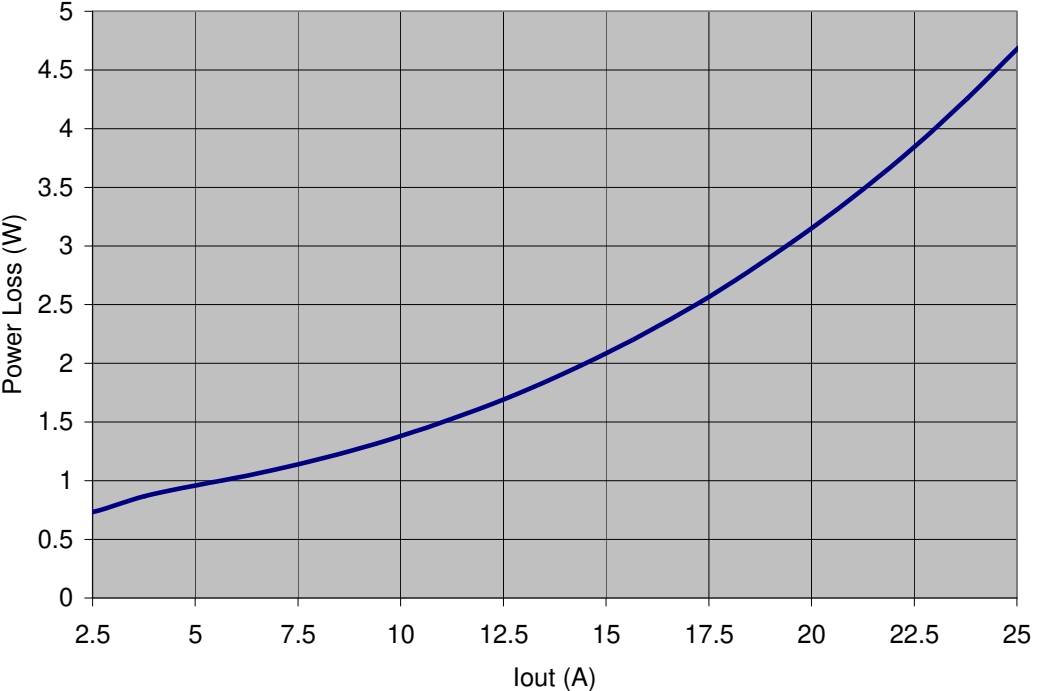

Fig.12: Power loss versus load current

THERMAL IMAGES

Vin=12.0V, Vcc=3.3V, Vo=1.8V, Io=0A-25A, Room Temperature, 200 LFM



Fig. 13: Thermal Image of the board at 25A load
Test point 1 is iP1827
Test point 2 is inductor

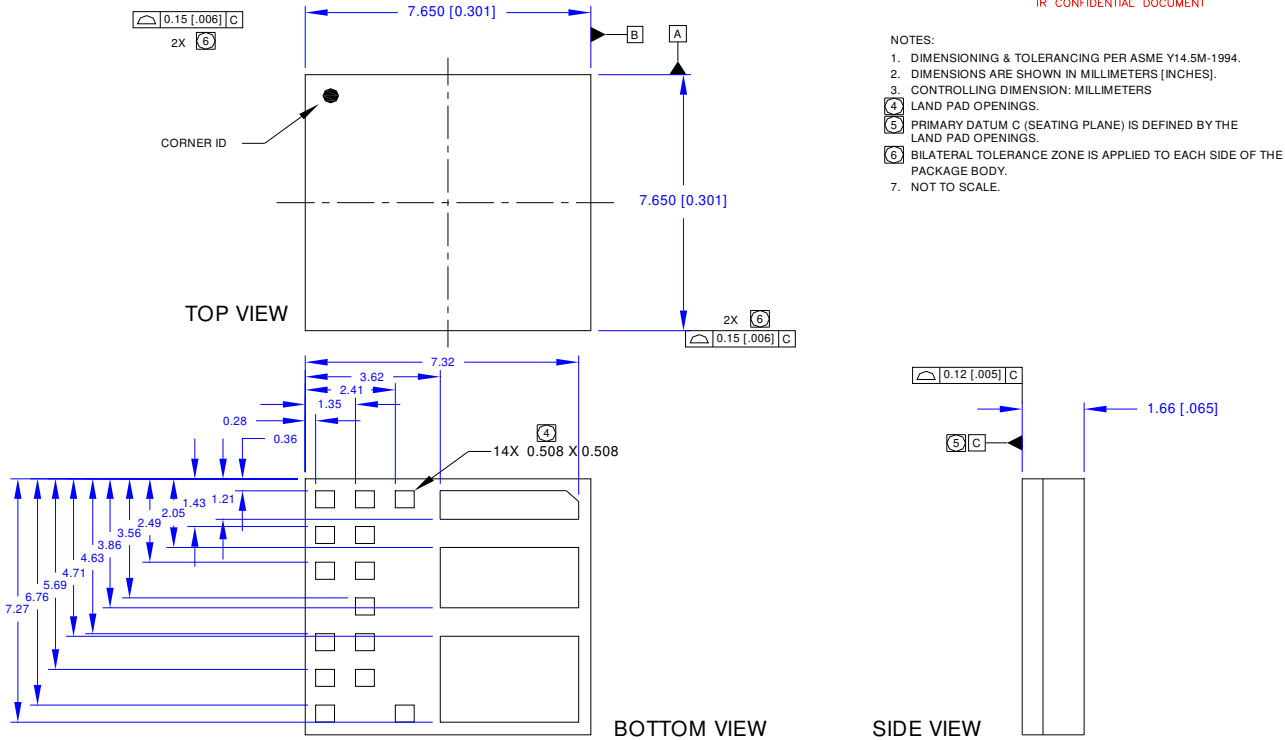
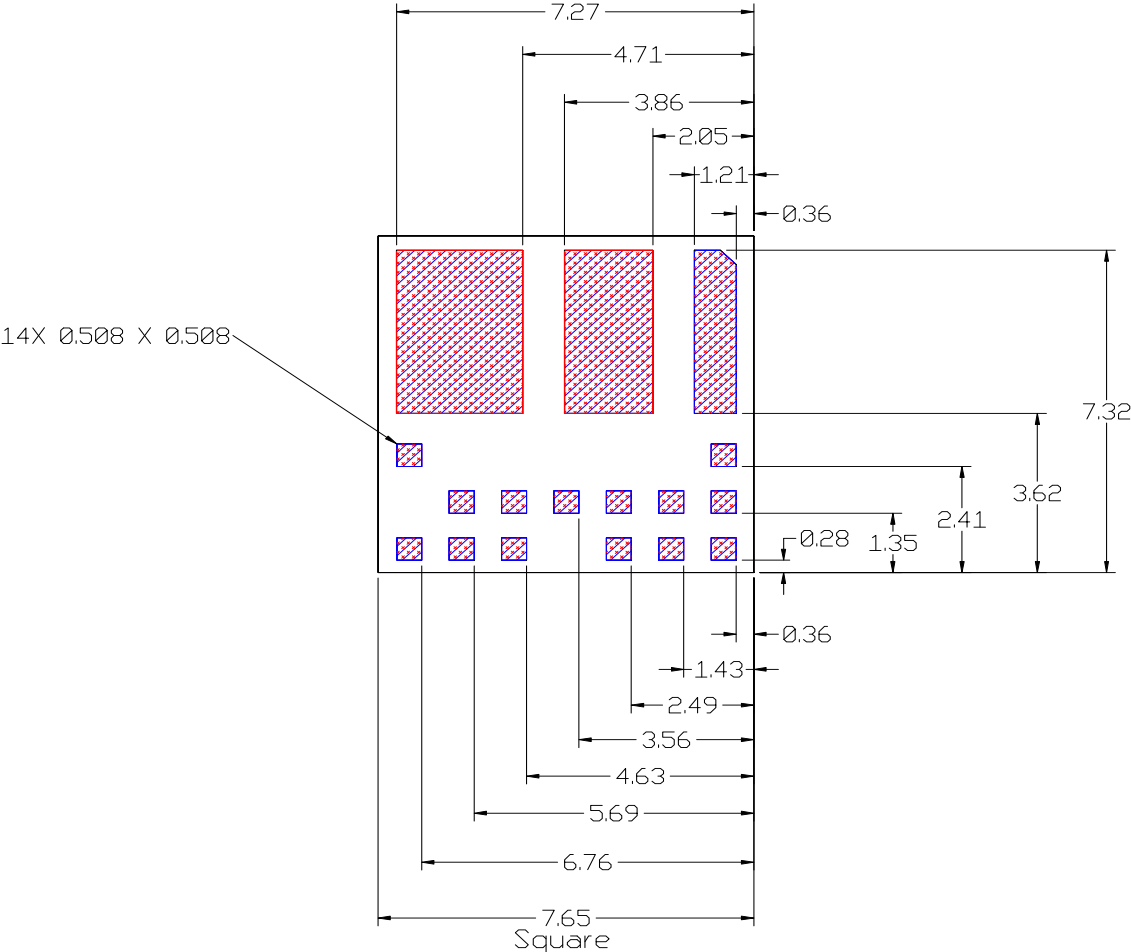

Fig. 14. Mechanical Outline Drawing



All dimensions in mm

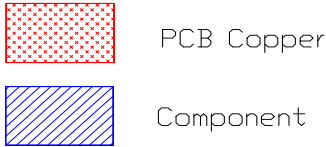
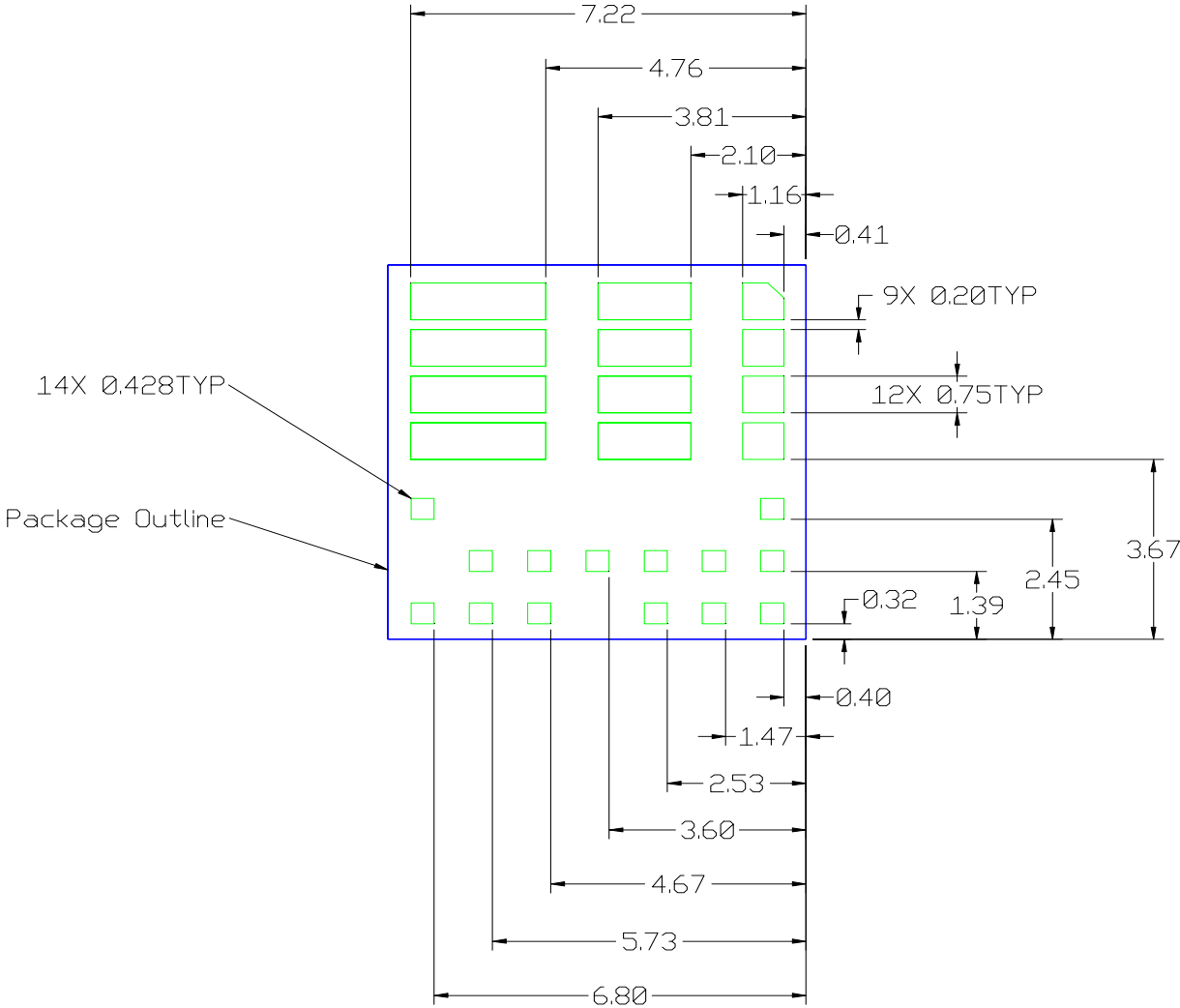

Fig. 15. PCB Metal and Components Placement



Stencil Aperture

All dimensions in mm

Fig. 16. Stencil Design

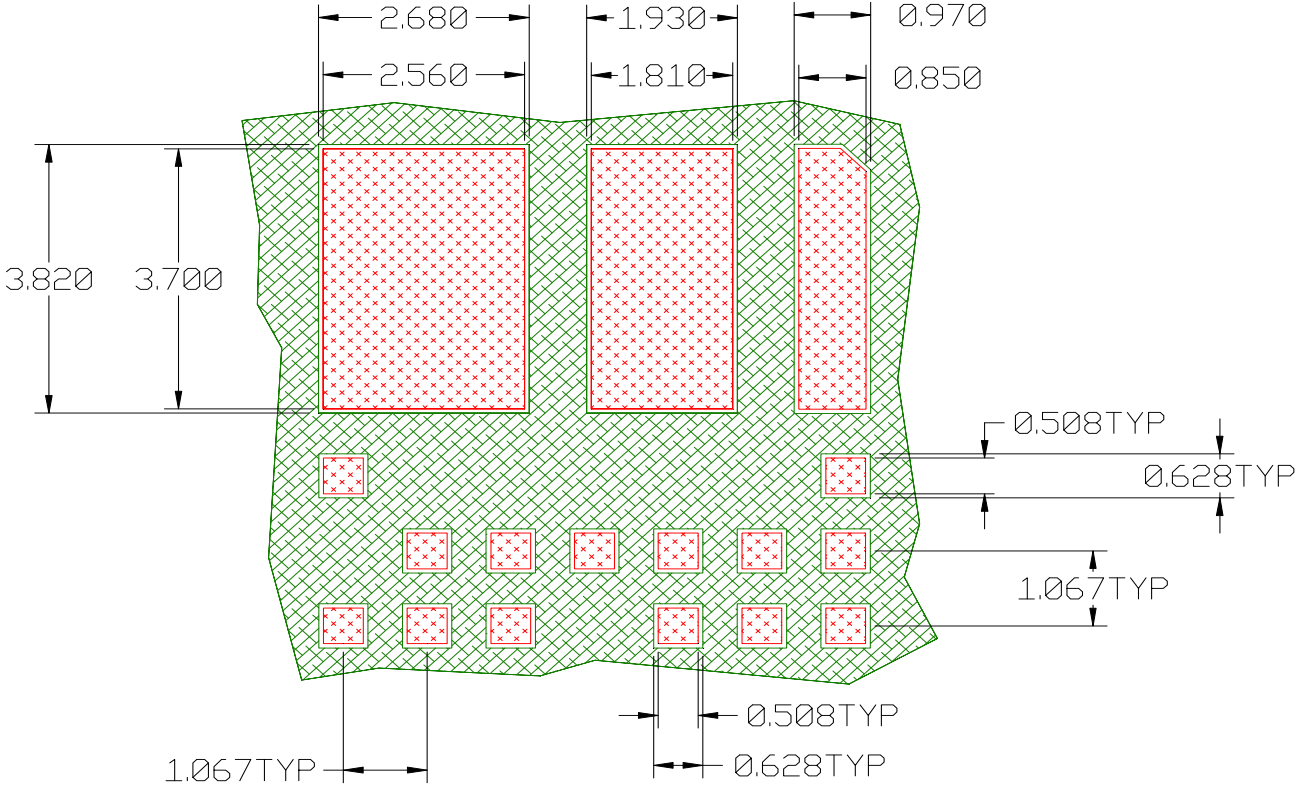

All dimensions in mm

-  PCB Copper
-  PCB Solder Resist

Fig. 17. Solder Resist

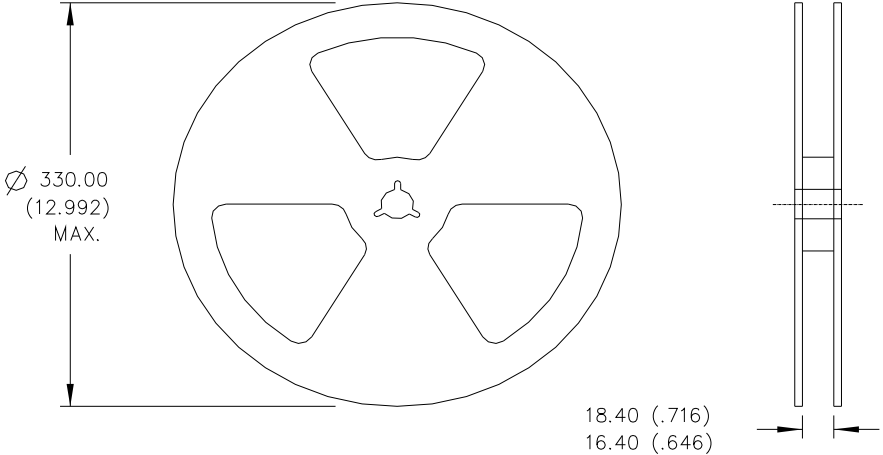
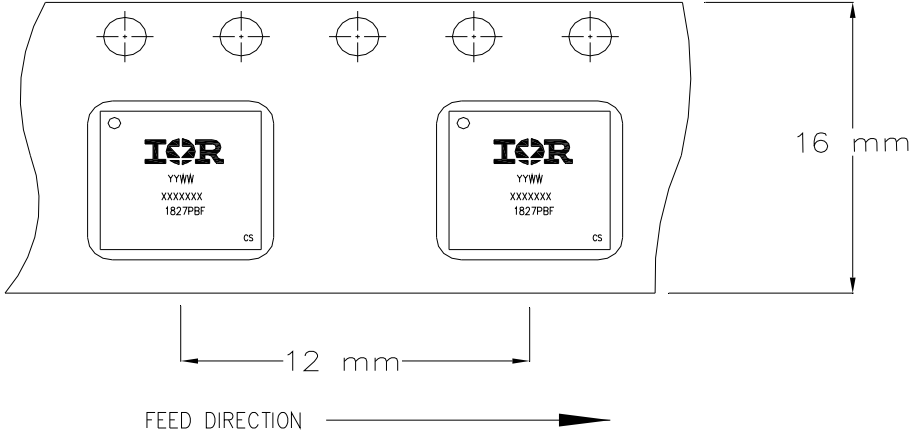

- NOTES:
1. CONTROLLING DIMENSION: MILLIMETER.
 2. ALL DIMENSIONS ARE SHOWN IN MILLIMETERS (INCHES).
 3. OUTLINE CONFORMS TO EIA-481 & EIA-541.

Fig. 18. Tape and Reel Information

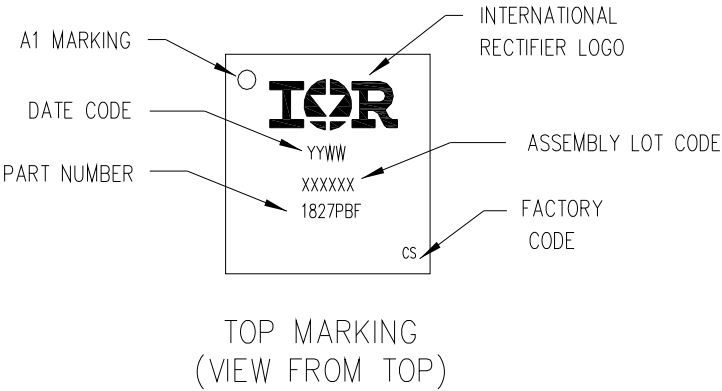

Fig. 19. Part Marking