



Chipsmall Limited consists of a professional team with an average of over 10 year of expertise in the distribution of electronic components. Based in Hongkong, we have already established firm and mutual-benefit business relationships with customers from,Europe,America and south Asia,supplying obsolete and hard-to-find components to meet their specific needs.

With the principle of “Quality Parts,Customers Priority,Honest Operation,and Considerate Service”,our business mainly focus on the distribution of electronic components. Line cards we deal with include Microchip,ALPS,ROHM,Xilinx,Pulse,ON,Everlight and Freescale. Main products comprise IC,Modules,Potentiometer,IC Socket,Relay,Connector.Our parts cover such applications as commercial,industrial, and automotives areas.

We are looking forward to setting up business relationship with you and hope to provide you with the best service and solution. Let us make a better world for our industry!



Contact us

Tel: +86-755-8981 8866 Fax: +86-755-8427 6832

Email & Skype: info@chipsmall.com Web: www.chipsmall.com

Address: A1208, Overseas Decoration Building, #122 Zhenhua RD., Futian, Shenzhen, China



IRF7389

HEXFET® Power MOSFET

- Generation V Technology
- Ultra Low On-Resistance
- Complimentary Half Bridge
- Surface Mount
- Fully Avalanche Rated

Description

Fifth Generation HEXFETs from International Rectifier utilize advanced processing techniques to achieve extremely low on-resistance per silicon area. This benefit, combined with the fast switching speed and ruggedized device design that HEXFET Power MOSFETs are well known for, provides the designer with an extremely efficient and reliable device for use in a wide variety of applications.

The SO-8 has been modified through a customized leadframe for enhanced thermal characteristics and multiple-die capability making it ideal in a variety of power applications. With these improvements, multiple devices can be used in an application with dramatically reduced board space. The package is designed for vapor phase, infra red, or wave soldering techniques.

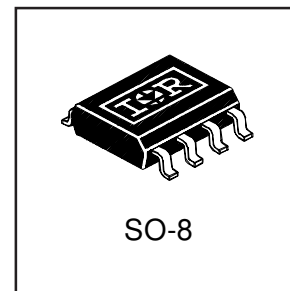
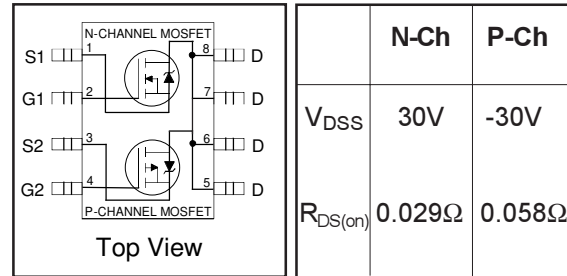

Absolute Maximum Ratings ($T_A = 25^\circ\text{C}$ Unless Otherwise Noted)

	Symbol	Maximum		Units
		N-Channel	P-Channel	
Drain-Source Voltage	V_{DS}	30	-30	
Gate-Source Voltage	V_{GS}	± 20		
Continuous Drain Current [Ⓢ]	$T_A = 25^\circ\text{C}$ $T_A = 70^\circ\text{C}$	7.3	-5.3	A
		5.9	-4.2	
Pulsed Drain Current	I_{DM}	30	-30	
Continuous Source Current (Diode Conduction)	I_S	2.5	-2.5	
Maximum Power Dissipation [Ⓢ]	$T_A = 25^\circ\text{C}$ $T_A = 70^\circ\text{C}$	2.5		W
		1.6		
Single Pulse Avalanche Energy	E_{AS}	82	140	mJ
Avalanche Current	I_{AR}	4.0	-2.8	A
Repetitive Avalanche Energy	E_{AR}	0.20		mJ
Peak Diode Recovery dv/dt [Ⓢ]	dv/dt	3.8	-2.2	V/ ns
Junction and Storage Temperature Range	T_J, T_{STG}	-55 to + 150 °C		

Thermal Resistance Ratings

Parameter	Symbol	Limit	Units
Maximum Junction-to-Ambient [Ⓢ]	$R_{\theta JA}$	50	$^\circ\text{C/W}$

Electrical Characteristics @ T_J = 25°C (unless otherwise specified)

Parameter	Min.	Typ.	Max.	Units	Conditions	
						Parameter
V _{(BR)DSS}	N-Ch	30	—	—	V	V _{GS} = 0V, I _D = 250μA
	P-Ch	-30	—	—		V _{GS} = 0V, I _D = -250μA
ΔV _{(BR)DSS} /ΔT _J	N-Ch	—	0.022	—	V/°C	Reference to 25°C, I _D = 1mA
	P-Ch	—	0.022	—		Reference to 25°C, I _D = -1mA
R _{DS(ON)}	N-Ch	—	0.023	0.029	Ω	V _{GS} = 10V, I _D = 5.8A ④
		—	0.032	0.046		V _{GS} = 4.5V, I _D = 4.7A ④
	P-Ch	—	0.042	0.058		V _{GS} = -10V, I _D = -4.9A ④
		—	0.076	0.098		V _{GS} = -4.5V, I _D = -3.6A ④
V _{GS(th)}	N-Ch	1.0	—	—	V	V _{DS} = V _{GS} , I _D = 250μA
	P-Ch	-1.0	—	—		V _{DS} = V _{GS} , I _D = -250μA
g _{fs}	N-Ch	—	14	—	S	V _{DS} = 15V, I _D = 5.8A ④
	P-Ch	—	7.7	—		V _{DS} = -15V, I _D = -4.9A ④
I _{DSS}	N-Ch	—	—	1.0	μA	V _{DS} = 24V, V _{GS} = 0V
	P-Ch	—	—	-1.0		V _{DS} = -24V, V _{GS} = 0V
	N-Ch	—	—	25		V _{DS} = 24V, V _{GS} = 0V, T _J = 55°C
	P-Ch	—	—	-25		V _{DS} = -24V, V _{GS} = 0V, T _J = 55°C
I _{GSS}	N-P	—	—	±100	nA	V _{GS} = ±20V
Q _g	N-Ch	—	22	33	nC	N-Channel I _D = 5.8A, V _{DS} = 15V, V _{GS} = 10V ④
	P-Ch	—	23	34		
Q _{gs}	N-Ch	—	2.6	3.9	nC	P-Channel I _D = -4.9A, V _{DS} = -15V, V _{GS} = -10V ④
	P-Ch	—	3.8	5.7		
Q _{gd}	N-Ch	—	6.4	9.6	nC	N-Channel V _{DD} = 15V, I _D = 1.0A, R _G = 6.0Ω, R _D = 15Ω ④
	P-Ch	—	5.9	8.9		
t _{d(on)}	N-Ch	—	8.1	12	ns	P-Channel V _{DD} = -15V, I _D = -1.0A, R _G = 6.0Ω, R _D = 15Ω ④
	P-Ch	—	13	19		
t _r	N-Ch	—	8.9	13	ns	N-Channel V _{GS} = 0V, V _{DS} = 25V, f = 1.0MHz
	P-Ch	—	13	20		
t _{d(off)}	N-Ch	—	26	39	ns	P-Channel V _{GS} = 0V, V _{DS} = -25V, f = 1.0MHz
	P-Ch	—	34	51		
t _f	N-Ch	—	17	26	ns	N-Channel V _{GS} = 0V, V _{DS} = 25V, f = 1.0MHz
	P-Ch	—	32	48		
C _{iss}	N-Ch	—	650	—	pF	P-Channel V _{GS} = 0V, V _{DS} = -25V, f = 1.0MHz
	P-Ch	—	710	—		
C _{oss}	N-Ch	—	320	—	pF	N-Channel V _{GS} = 0V, V _{DS} = 25V, f = 1.0MHz
	P-Ch	—	380	—		
C _{rss}	N-Ch	—	130	—	pF	P-Channel V _{GS} = 0V, V _{DS} = -25V, f = 1.0MHz
	P-Ch	—	180	—		

Source-Drain Ratings and Characteristics

Parameter	Min.	Typ.	Max.	Units	Conditions	
I _S	N-Ch	—	2.5	A		
	P-Ch	—	-2.5			
I _{SM}	N-Ch	—	30	A		
	P-Ch	—	-30			
V _{SD}	N-Ch	—	0.78	1.0	V	T _J = 25°C, I _S = 1.7A, V _{GS} = 0V ③
	P-Ch	—	-0.78	-1.0		T _J = 25°C, I _S = -1.7A, V _{GS} = 0V ③
t _{rr}	N-Ch	—	45	68	ns	N-Channel T _J = 25°C, I _F = 1.7A, di/dt = 100A/μs ④
	P-Ch	—	44	66		
Q _{rr}	N-Ch	—	58	87	nC	P-Channel T _J = 25°C, I _F = -1.7A, di/dt = 100A/μs ④
	P-Ch	—	42	63		

Notes:

- ① Repetitive rating; pulse width limited by max. junction temperature. (See fig. 22)
- ② N-Channel I_{SD} ≤ 4.0A, di/dt ≤ 74A/μs, V_{DD} ≤ V_{(BR)DSS}, T_J ≤ 150°C
P-Channel I_{SD} ≤ -2.8A, di/dt ≤ 150A/μs, V_{DD} ≤ V_{(BR)DSS}, T_J ≤ 150°C
- ③ N-Channel Starting T_J = 25°C, L = 10mH R_G = 25Ω, I_{AS} = 4.0A. (See Figure 12)
P-Channel Starting T_J = 25°C, L = 35mH R_G = 25Ω, I_{AS} = -2.8A.
- ④ Pulse width ≤ 300μs; duty cycle ≤ 2%.
- ⑤ Surface mounted on FR-4 board, t ≤ 10sec.

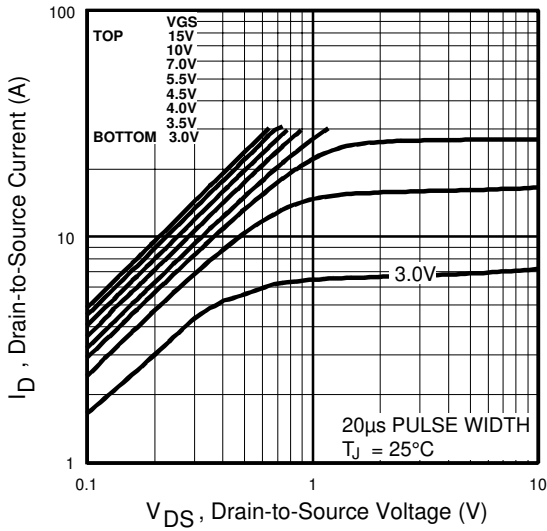

Fig 1. Typical Output Characteristics

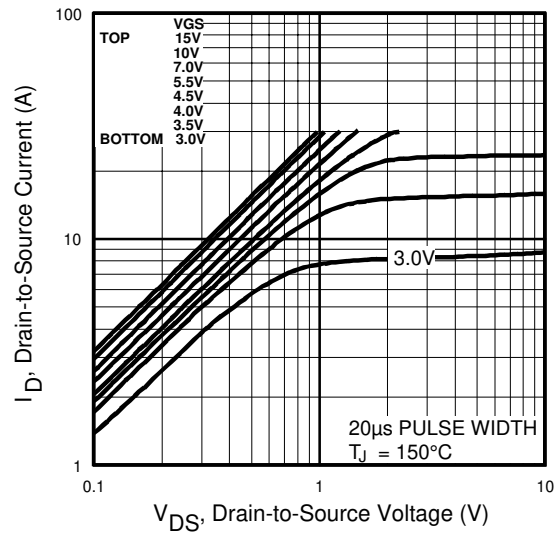

Fig 2. Typical Output Characteristics

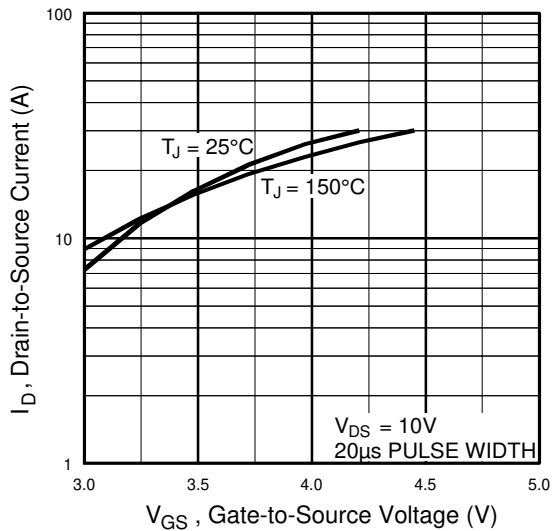

Fig 3. Typical Transfer Characteristics

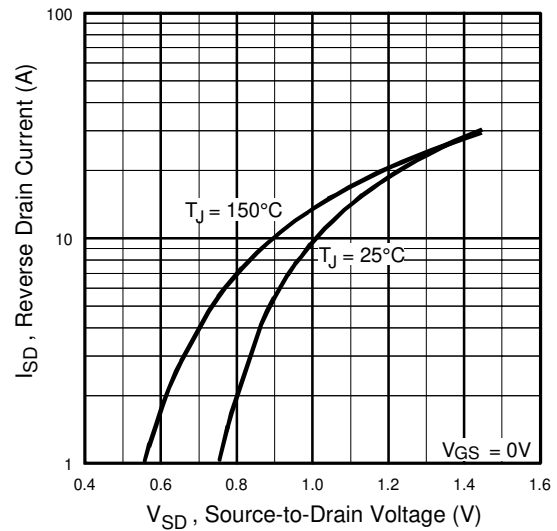

Fig 4. Typical Source-Drain Diode Forward Voltage

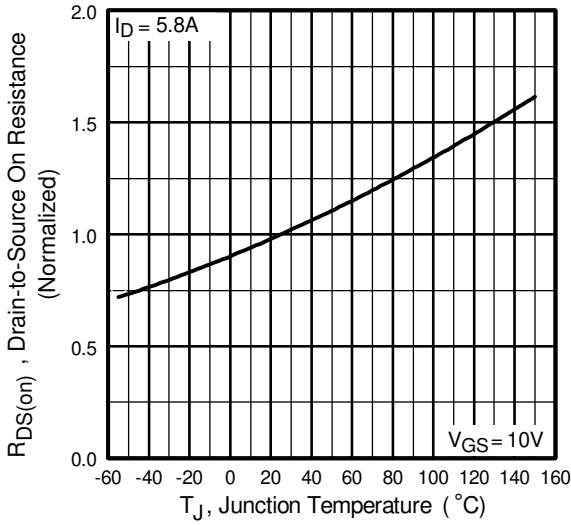

Fig 5. Normalized On-Resistance Vs. Temperature

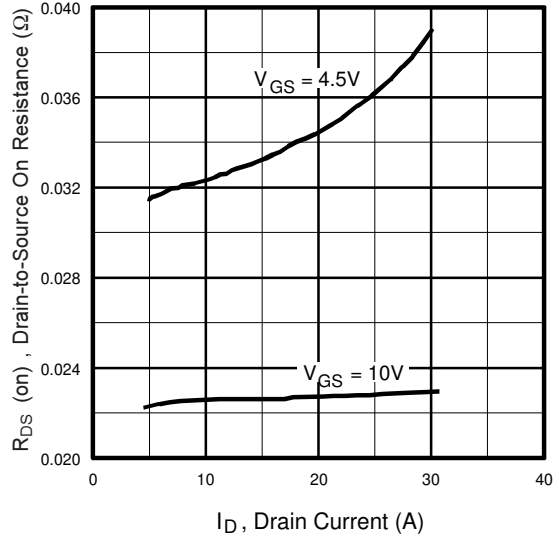

Fig 6. Typical On-Resistance Vs. Drain Current

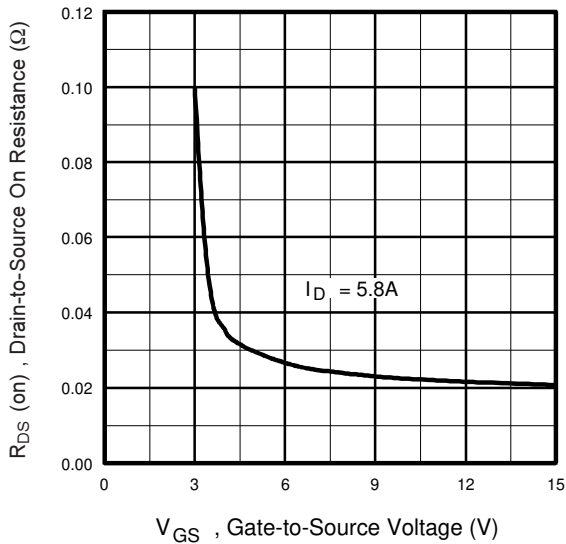

Fig 7. Typical On-Resistance Vs. Gate Voltage

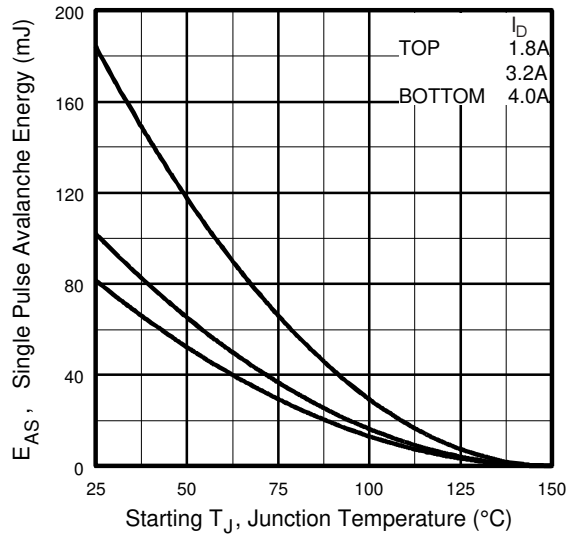

Fig 8. Maximum Avalanche Energy Vs. Drain Current

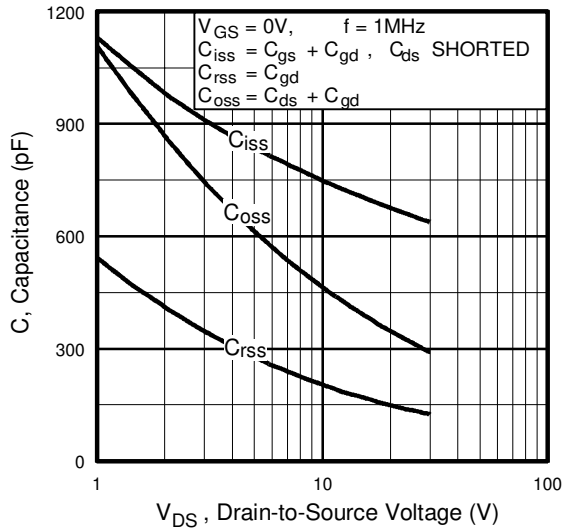

Fig 9. Typical Capacitance Vs. Drain-to-Source Voltage

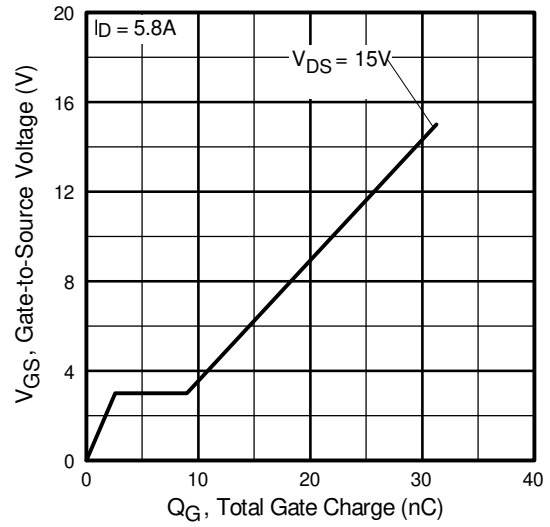

Fig 10. Typical Gate Charge Vs. Gate-to-Source Voltage

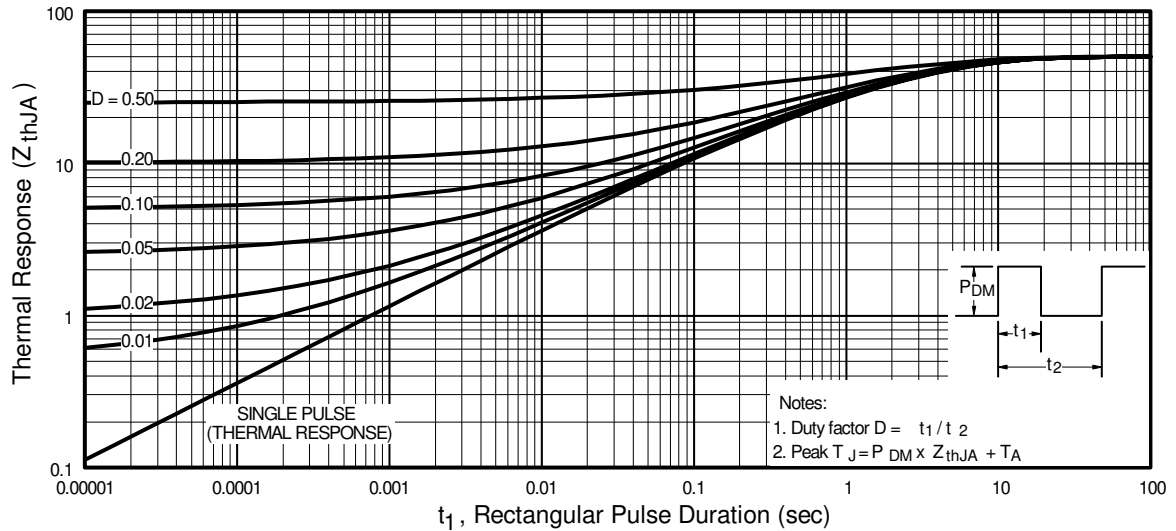

Fig 11. Maximum Effective Transient Thermal Impedance, Junction-to-Ambient

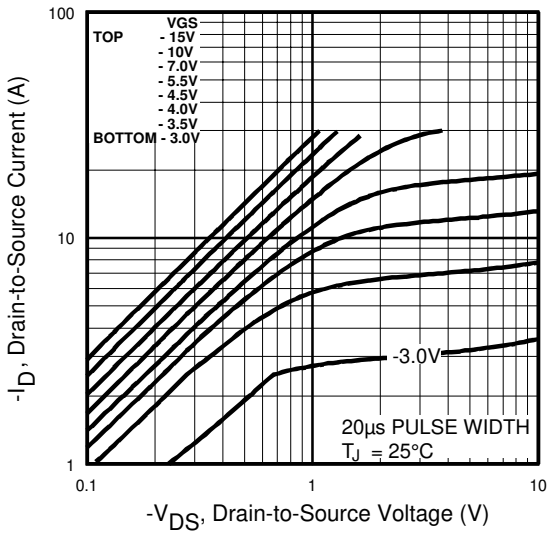

Fig 12. Typical Output Characteristics

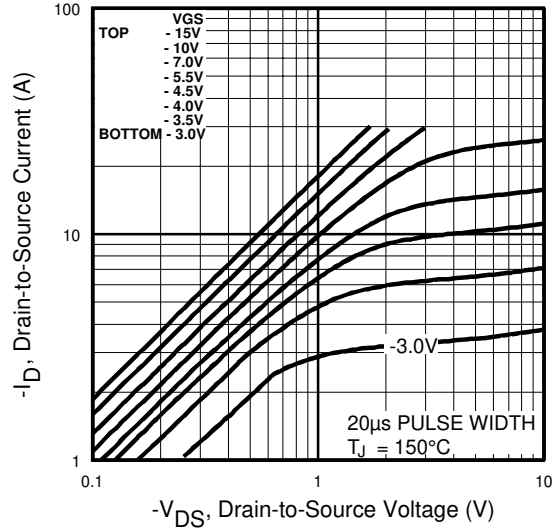

Fig 13. Typical Output Characteristics

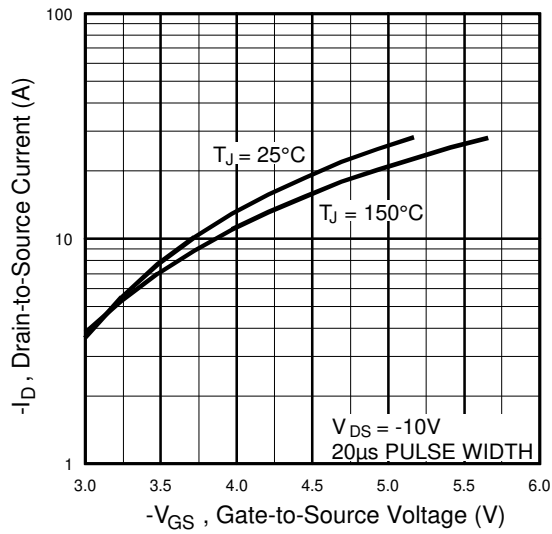

Fig 14. Typical Transfer Characteristics

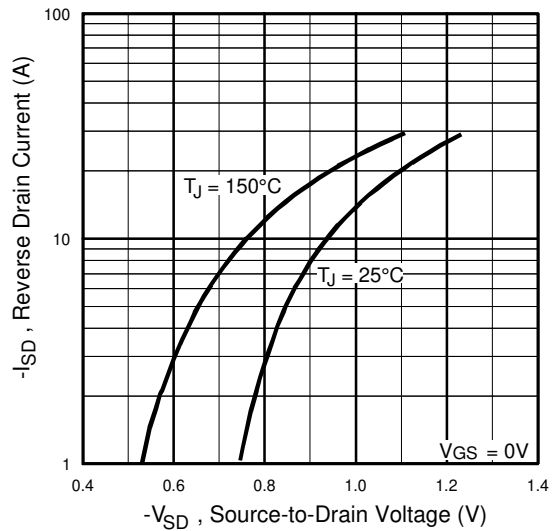

Fig 15. Typical Source-Drain Diode Forward Voltage

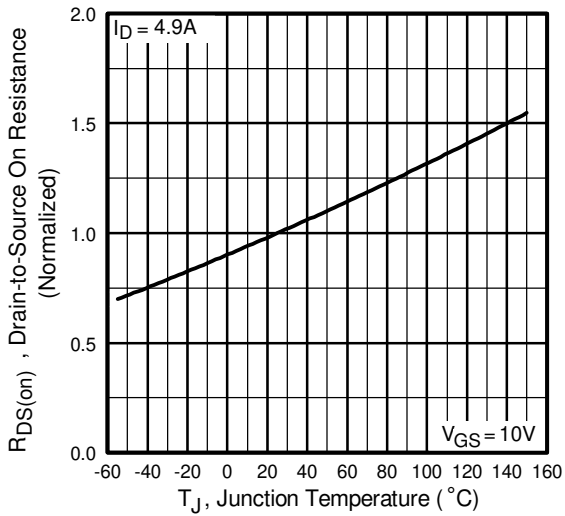

Fig 16. Normalized On-Resistance Vs. Temperature

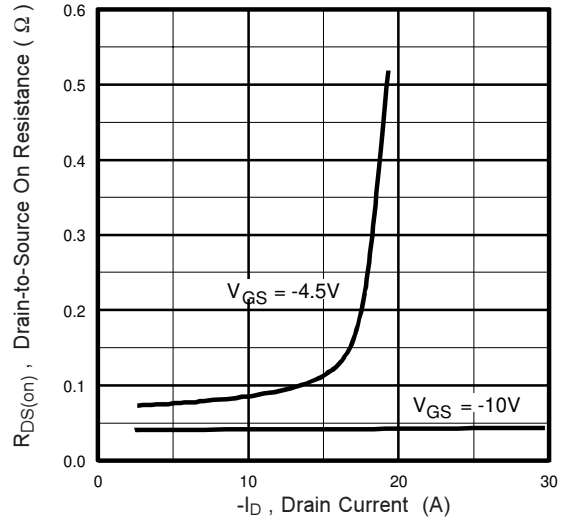

Fig 17. Typical On-Resistance Vs. Drain Current

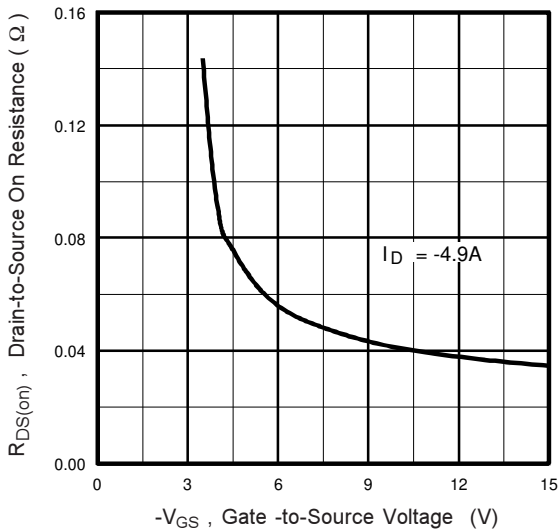

Fig 18. Typical On-Resistance Vs. Gate Voltage

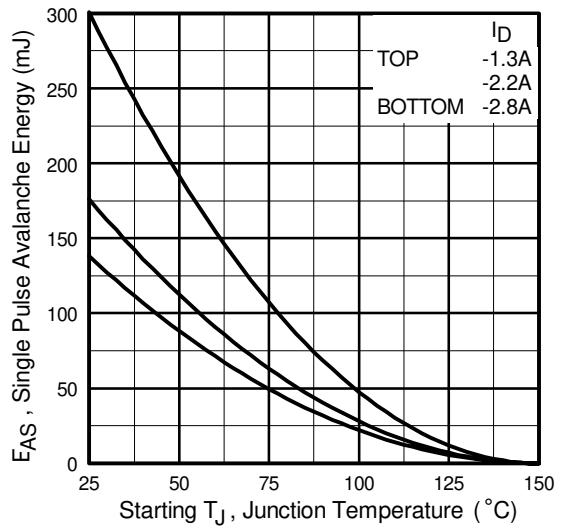

Fig 19. Maximum Avalanche Energy Vs. Drain Current

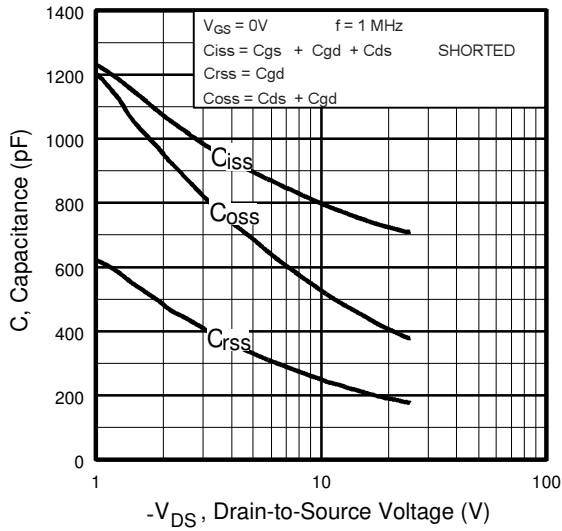

Fig 20. Typical Capacitance Vs. Drain-to-Source Voltage

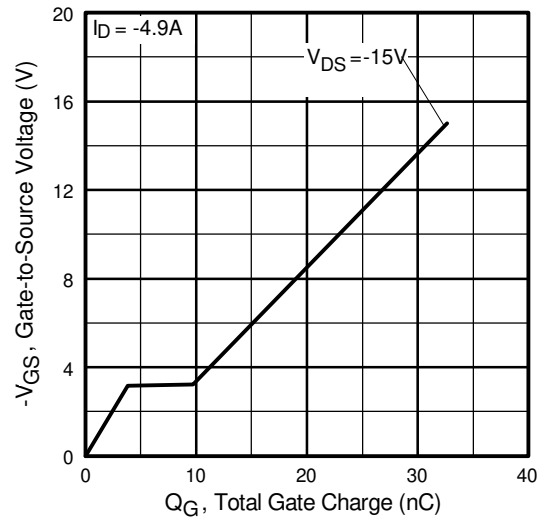

Fig 21. Typical Gate Charge Vs. Gate-to-Source Voltage

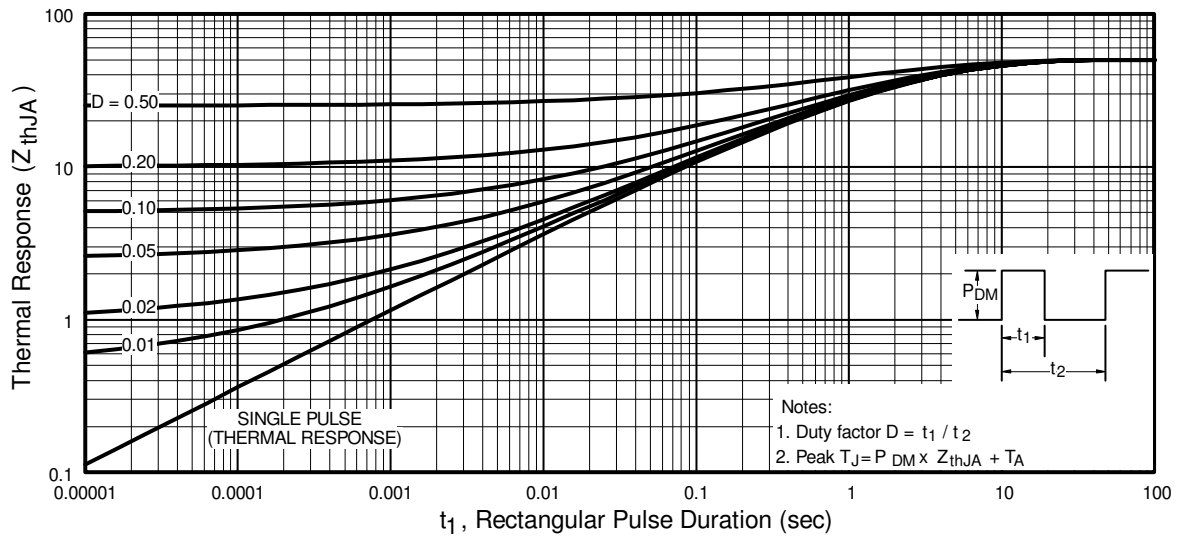
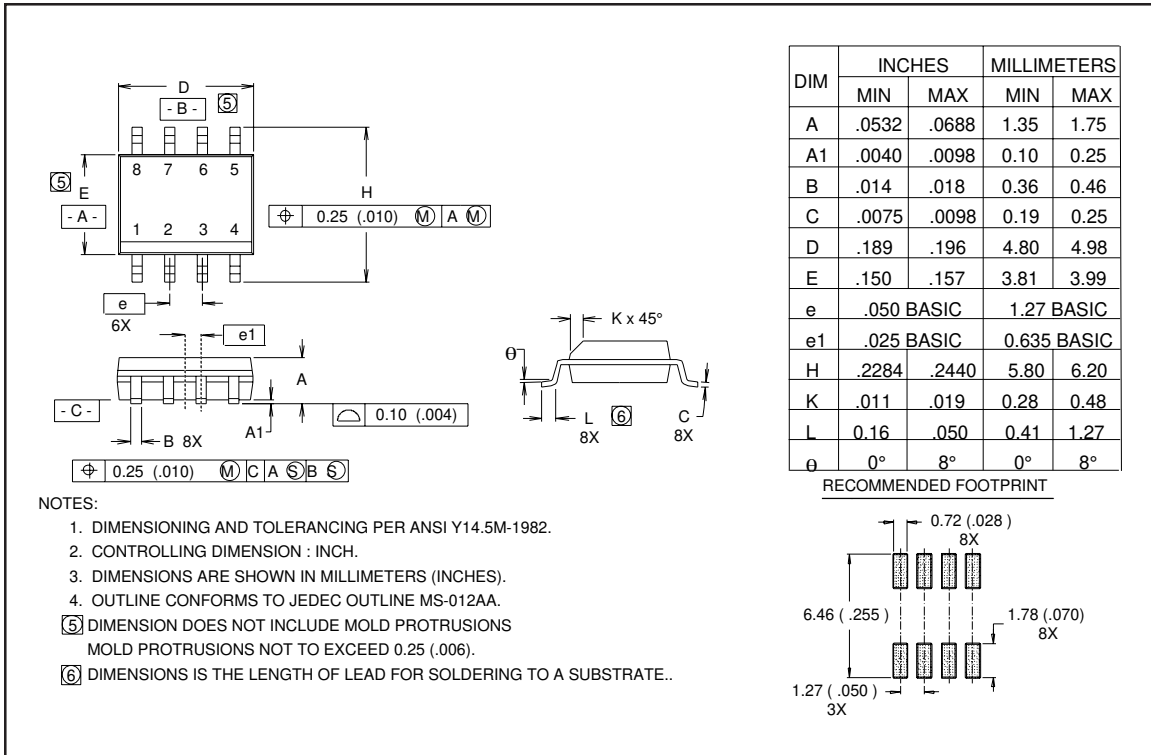

Fig 22. Maximum Effective Transient Thermal Impedance, Junction-to-Ambient

Package Outline SO8 Outline



Part Marking Information

SO8

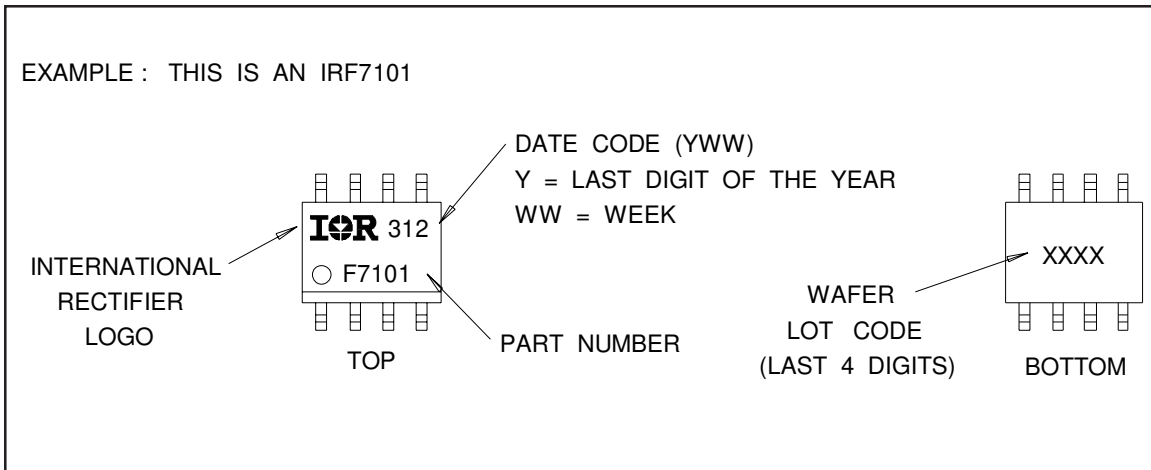

IRF7389

International
IR Rectifier

Tape & Reel Information

S08

Dimensions are shown in millimeters (inches)

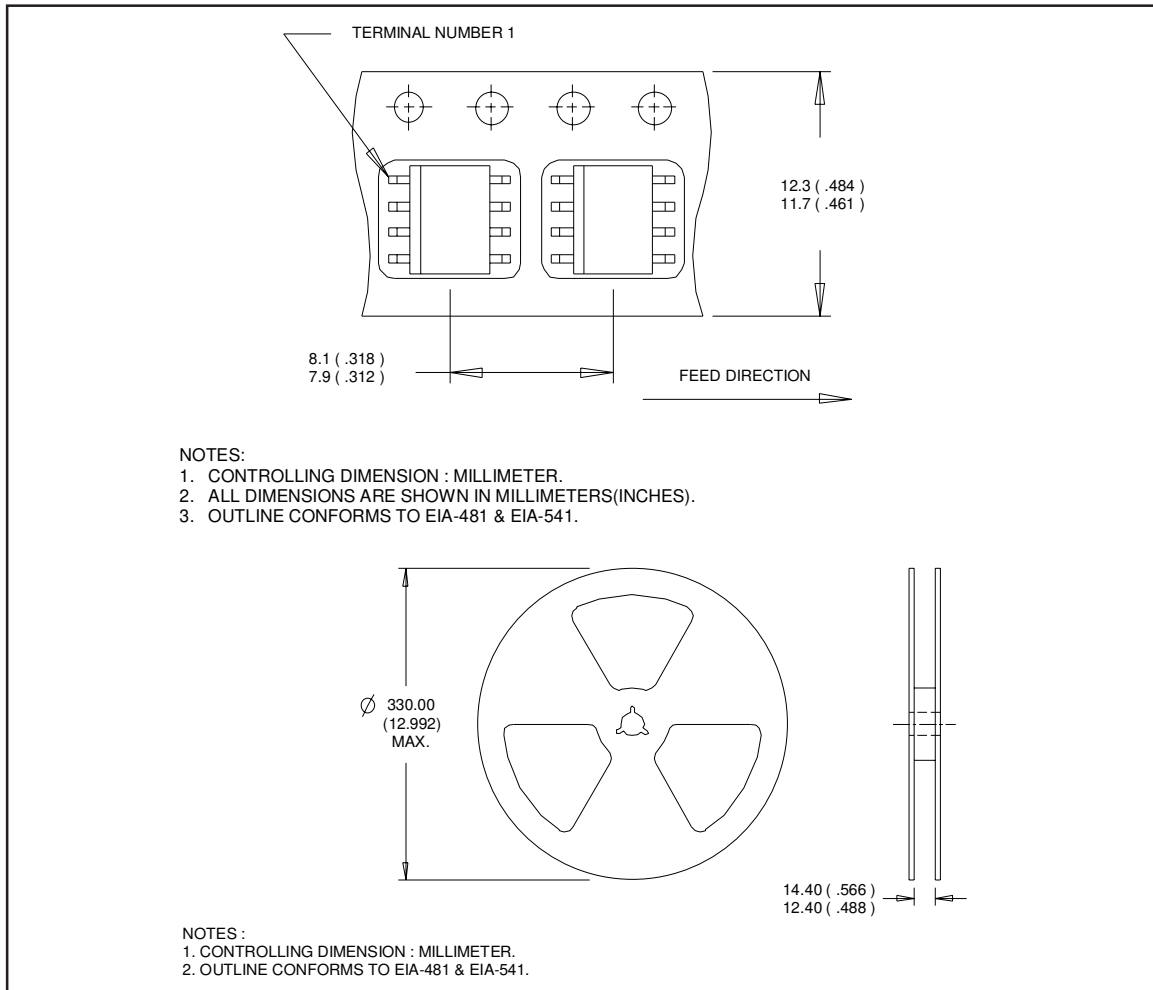

Data and specifications subject to change without notice.

International
IR Rectifier

IR WORLD HEADQUARTERS: 233 Kansas St., El Segundo, California 90245, USA Tel: (310) 252-7105
TAC Fax: (310) 252-7903

Visit us at www.irf.com for sales contact information. 02/04

www.irf.com