



Chipsmall Limited consists of a professional team with an average of over 10 year of expertise in the distribution of electronic components. Based in Hongkong, we have already established firm and mutual-benefit business relationships with customers from,Europe,America and south Asia,supplying obsolete and hard-to-find components to meet their specific needs.

With the principle of “Quality Parts,Customers Priority,Honest Operation,and Considerate Service”,our business mainly focus on the distribution of electronic components. Line cards we deal with include Microchip,ALPS,ROHM,Xilinx,Pulse,ON,Everlight and Freescale. Main products comprise IC,Modules,Potentiometer,IC Socket,Relay,Connector.Our parts cover such applications as commercial,industrial, and automotives areas.

We are looking forward to setting up business relationship with you and hope to provide you with the best service and solution. Let us make a better world for our industry!



Contact us

Tel: +86-755-8981 8866 Fax: +86-755-8427 6832

Email & Skype: info@chipsmall.com Web: www.chipsmall.com

Address: A1208, Overseas Decoration Building, #122 Zhenhua RD., Futian, Shenzhen, China



IRF7754

HEXFET® Power MOSFET

- Ultra Low On-Resistance
- P-Channel MOSFET
- Very Small SOIC Package
- Low Profile (< 1.2mm)
- Available in Tape & Reel

V_{DS}	$R_{DS(on)}$ max	I_D
-12V	25mΩ@ $V_{GS} = -4.5V$	-5.4A
	34mΩ@ $V_{GS} = -2.5V$	-4.6A
	49mΩ@ $V_{GS} = -1.8V$	-3.9A

Description

HEXFET® Power MOSFETs from International Rectifier utilize advanced processing techniques to achieve extremely low on-resistance per silicon area. This benefit, combined with the ruggedized device design, that International Rectifier is well known for, provides the designer with an extremely efficient and reliable device for battery and load management.

The TSSOP-8 package has 45% less footprint area than the standard SO-8. This makes the TSSOP-8 an ideal device for applications where printed circuit board space is at a premium. The low profile (<1.2mm) allows it to fit easily into extremely thin environments such as portable electronics and PCMCIA cards.

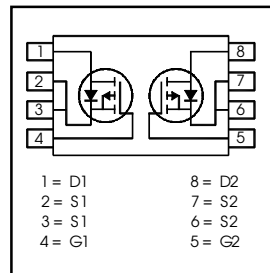

Absolute Maximum Ratings

	Parameter	Max.	Units
V_{DS}	Drain-Source Voltage	-12	V
$I_D @ T_A = 25^\circ C$	Continuous Drain Current, $V_{GS} @ -4.5V$	-5.5	A
$I_D @ T_A = 70^\circ C$	Continuous Drain Current, $V_{GS} @ -4.5V$	-4.4	
I_{DM}	Pulsed Drain Current ^①	-22	
$P_D @ T_A = 25^\circ C$	Maximum Power Dissipation ^③	1	W
$P_D @ T_A = 70^\circ C$	Maximum Power Dissipation ^③	0.64	W
	Linear Derating Factor	0.01	W/°C
V_{GS}	Gate-to-Source Voltage	±8	V
T_J, T_{STG}	Junction and Storage Temperature Range	-55 to +150	°C

Thermal Resistance

	Parameter	Max.	Units
$R_{\theta JA}$	Maximum Junction-to-Ambient ^③	125	°C/W

Electrical Characteristics @ $T_J = 25^\circ\text{C}$ (unless otherwise specified)

	Parameter	Min.	Typ.	Max.	Units	Conditions
$V_{(BR)DSS}$	Drain-to-Source Breakdown Voltage	-12	—	—	V	$V_{GS} = 0V, I_D = -250\mu A$
$\Delta V_{(BR)DSS}/\Delta T_J$	Breakdown Voltage Temp. Coefficient	—	0.008	—	V/ $^\circ\text{C}$	Reference to 25°C , $I_D = -1\text{mA}$
$R_{DS(on)}$	Static Drain-to-Source On-Resistance	—	—	25	m Ω	$V_{GS} = -4.5V, I_D = -5.4A$ ②
		—	—	34		$V_{GS} = -2.5V, I_D = -4.6A$ ②
		—	—	49		$V_{GS} = -1.8V, I_D = -3.9A$ ②
$V_{GS(th)}$	Gate Threshold Voltage	-0.4	—	-0.9	V	$V_{DS} = V_{GS}, I_D = -250\mu A$
g_{fs}	Forward Transconductance	16	—	—	S	$V_{DS} = -10V, I_D = -5.4A$
I_{DSS}	Drain-to-Source Leakage Current	—	—	-1.0	μA	$V_{DS} = -9.6V, V_{GS} = 0V$
		—	—	-25		$V_{DS} = -9.6V, V_{GS} = 0V, T_J = 70^\circ\text{C}$
I_{GSS}	Gate-to-Source Forward Leakage	—	—	-100	nA	$V_{GS} = -8V$
	Gate-to-Source Reverse Leakage	—	—	100		$V_{GS} = 8V$
Q_g	Total Gate Charge	—	22	—	nC	$I_D = -5.4A$
Q_{gs}	Gate-to-Source Charge	—	3.9	—		$V_{DS} = -6V$
Q_{gd}	Gate-to-Drain ("Miller") Charge	—	4.8	—		$V_{GS} = -4.5V$ ②
$t_{d(on)}$	Turn-On Delay Time	—	9.8	14.7	ns	$V_{DD} = -6V, V_{GS} = -4.5V$
t_r	Rise Time	—	18	27		$I_D = -1.0A$
$t_{d(off)}$	Turn-Off Delay Time	—	267	401		$R_D = 6\Omega$
t_f	Fall Time	—	191	287		$R_G = 6\Omega$ ②
C_{iss}	Input Capacitance	—	1984	—	pF	$V_{GS} = 0V$
C_{oss}	Output Capacitance	—	618	—		$V_{DS} = -6V$
C_{rss}	Reverse Transfer Capacitance	—	385	—		$f = 1.0\text{MHz}$

Source-Drain Ratings and Characteristics

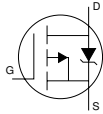
	Parameter	Min.	Typ.	Max.	Units	Conditions
I_S	Continuous Source Current (Body Diode)	—	—	-1.0	A	MOSFET symbol showing the integral reverse p-n junction diode. 
I_{SM}	Pulsed Source Current (Body Diode) ①	—	—	-22		
V_{SD}	Diode Forward Voltage	—	—	-1.2	V	$T_J = 25^\circ\text{C}, I_S = -1.0A, V_{GS} = 0V$ ②
t_{rr}	Reverse Recovery Time	—	39	59	ns	$T_J = 25^\circ\text{C}, I_F = -1.0A$
Q_{rr}	Reverse Recovery Charge	—	27	41	nC	$di/dt = -100A/\mu s$ ②

Notes:

① Repetitive rating; pulse width limited by max. junction temperature.

② Pulse width $\leq 400\mu s$; duty cycle $\leq 2\%$.

③ When mounted on 1 inch square copper board, $t < 10$ sec.

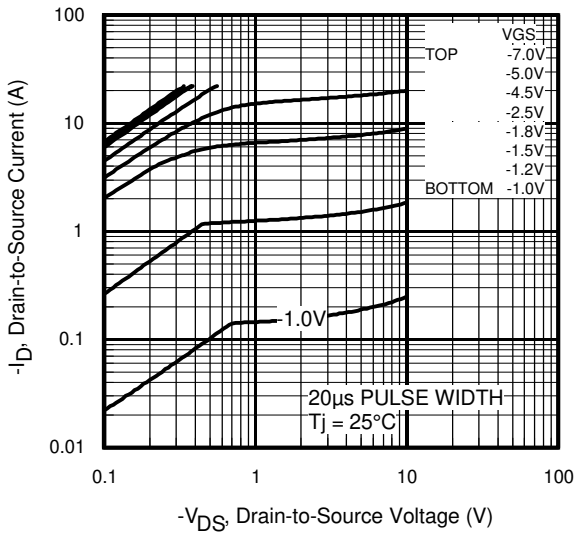

Fig 1. Typical Output Characteristics

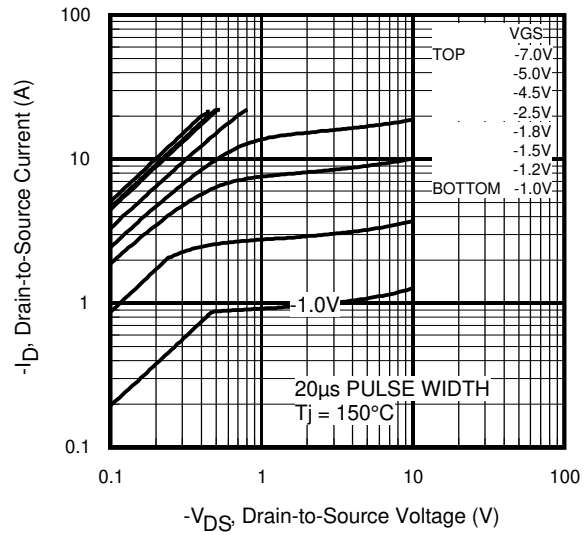

Fig 2. Typical Output Characteristics

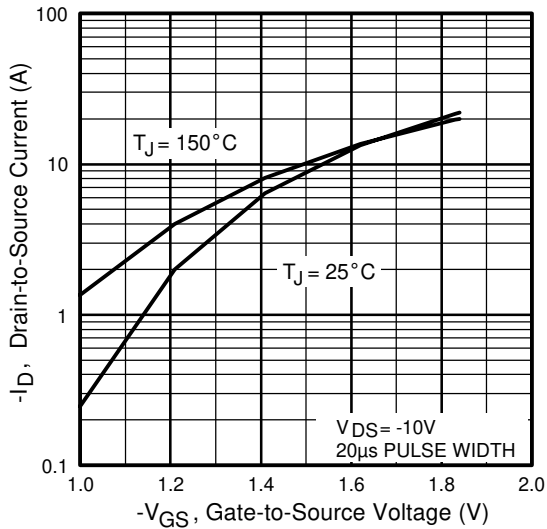

Fig 3. Typical Transfer Characteristics

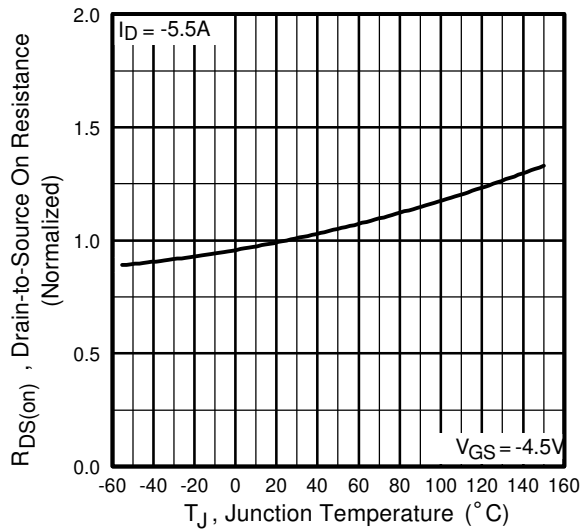

Fig 4. Normalized On-Resistance Vs. Temperature

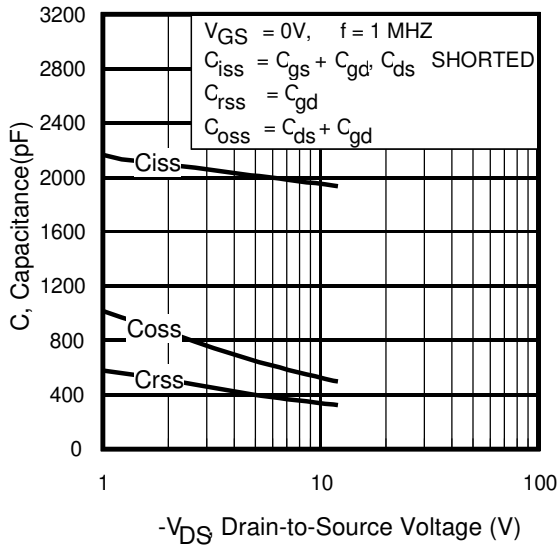

Fig 5. Typical Capacitance Vs. Drain-to-Source Voltage

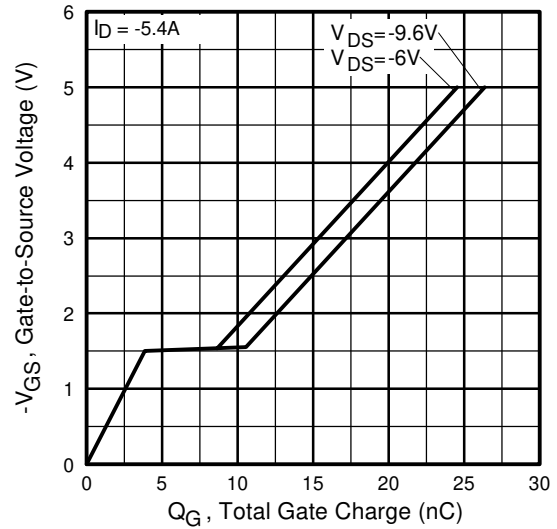

Fig 6. Typical Gate Charge Vs. Gate-to-Source Voltage

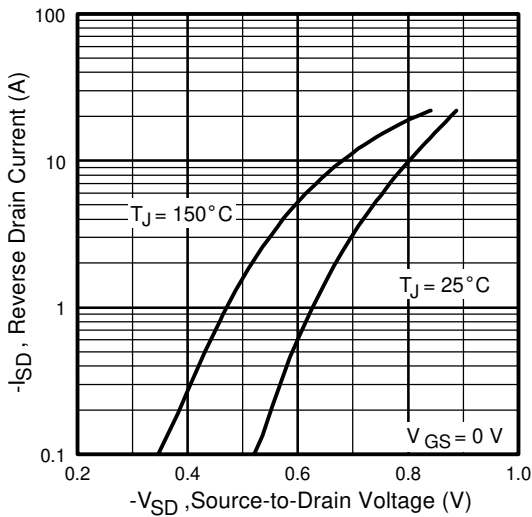

Fig 7. Typical Source-Drain Diode Forward Voltage

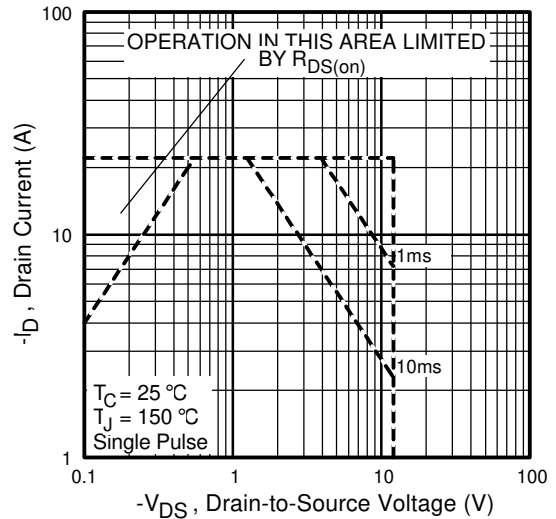

Fig 8. Maximum Safe Operating Area

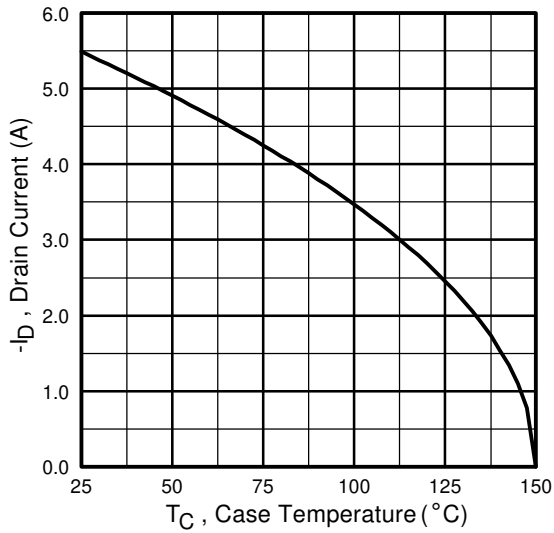

Fig 9. Maximum Drain Current Vs. Case Temperature

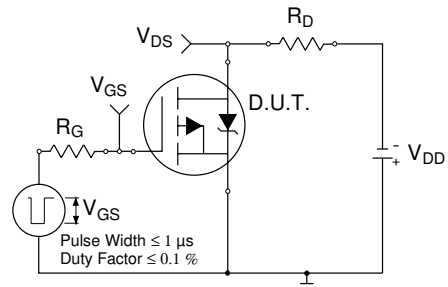

Fig 10a. Switching Time Test Circuit

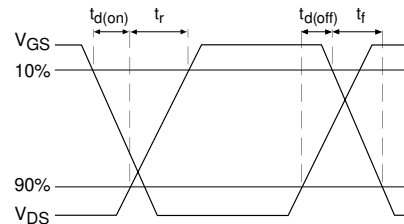

Fig 10b. Switching Time Waveforms

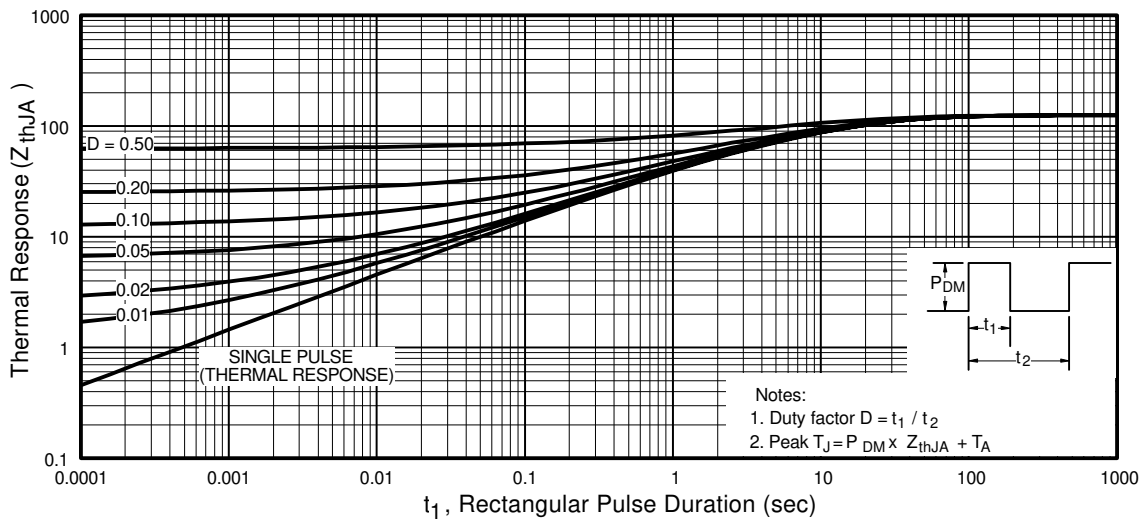

Fig 11. Maximum Effective Transient Thermal Impedance, Junction-to-Ambient

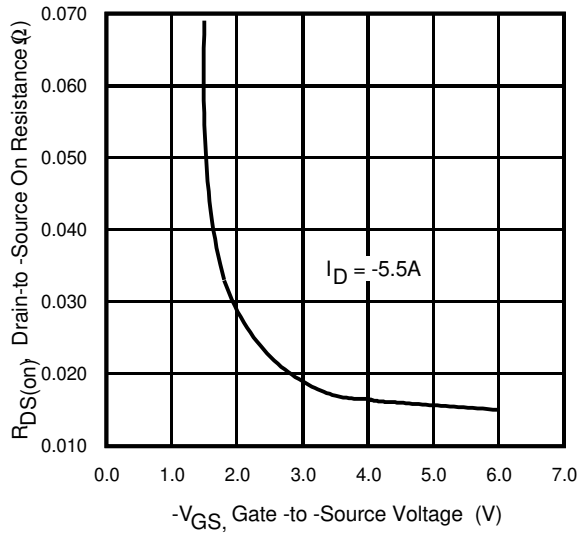

Fig 12. Typical On-Resistance Vs. Gate Voltage

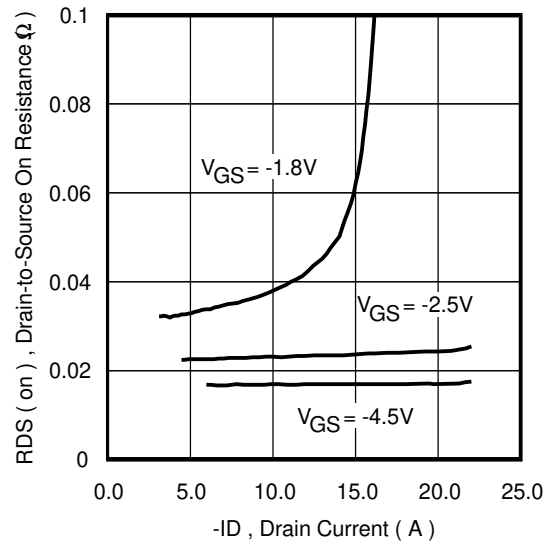

Fig 13. Typical On-Resistance Vs. Drain Current

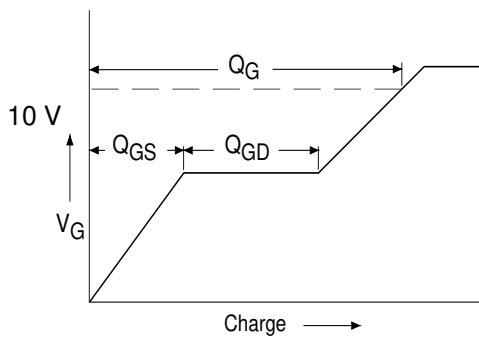

Fig 14a. Basic Gate Charge Waveform

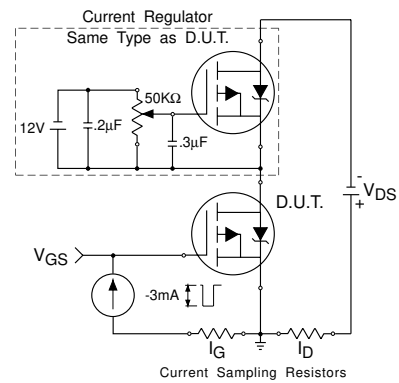

Fig 14b. Gate Charge Test Circuit

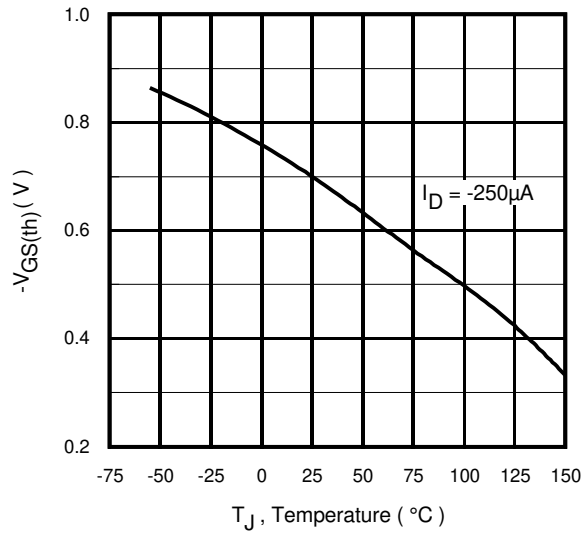

Fig 15. Typical $V_{GS(th)}$ Vs. Junction Temperature

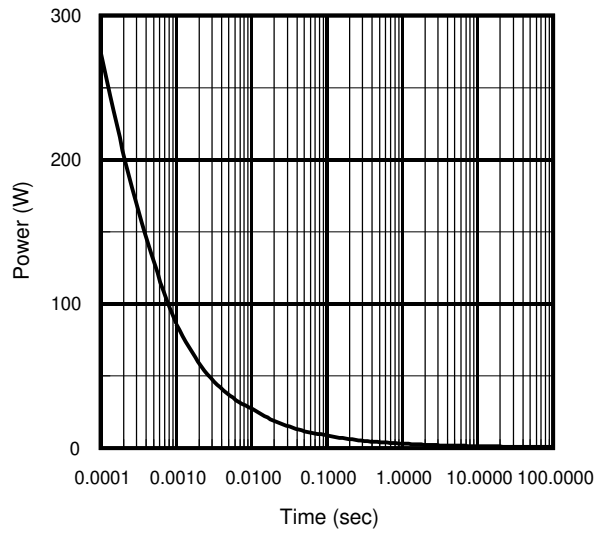
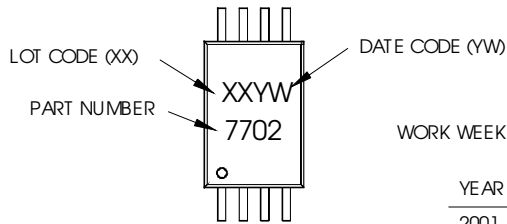

Fig 16. Typical Power Vs. Time

IRF7754

TSSOP-8 Part Marking Information

EXAMPLE: THIS IS AN IRF7702



DATE CODE EXAMPLES:

9503 = 5C
9532 = EF

TABLE 1

WORK WEEK 1-26, NUMERIC YEAR CODE (1,2, ...ETC.)

YEAR	Y	WORK WEEK	W
2001	1	01	A
2002	2	02	B
2003	3	03	C
1994	4	04	D
1995	5		
1996	6		
1997	7		
1998	8		
1999	9		
2000	0	24	X
		25	Y
		26	Z

TABLE 2

WORK WEEK 27-52, ALPHANUMERIC YEAR CODE (A,B, ...ETC.)

YEAR	Y	WORK WEEK	W
2001	A	27	A
2002	B	28	B
2003	C	29	C
1994	D	30	D
1995	E		
1996	F		
1997	G		
1998	H		
1999	J		
2000	K	50	X
		51	Y
		52	Z

TSSOP-8 Tape and Reel

8LTSSOP (MO-153AA)

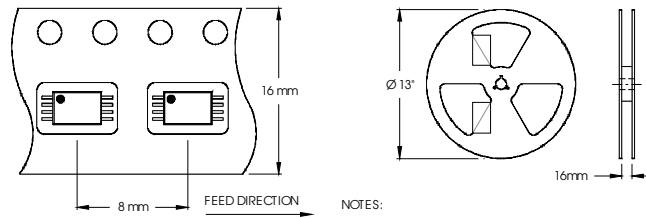

NOTES:

1. TAPE & REEL OUTLINE CONFORMS TO EIA-481 & EIA-541.

TSSOP-8 Package Outline

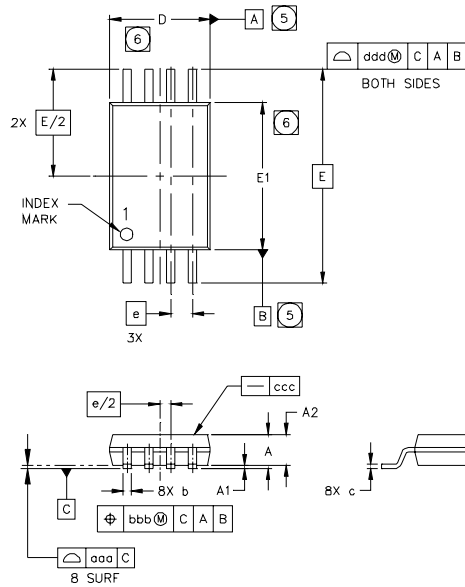

SYMBOL	MO-153AA DIMENSIONS					
	MILLIMETERS			INCHES		
	MIN	NOM	MAX	MIN	NOM	MAX
A	---	---	1.20	---	---	.0472
A1	0.05	---	0.15	.0020	---	.0059
A2	0.80	1.00	1.05	.032	.039	.041
b	0.19	---	0.30	.0075	---	.0118
c	0.09	---	0.20	.0036	---	.0078
D	2.90	3.00	3.10	.115	.118	.122
E	6.40 BSC			.251 BSC		
E1	4.30	4.40	4.50	.170	.173	.177
e	0.65 BSC			.0256		
L	0.45	0.60	0.75	.0178	.0236	.0290
L1	0.25 BSC			.010 BSC		
θ	0°	---	8°	0°	---	8°
aaa	0.10			.0039		
bbb	0.10			.0039		
ccc	0.05			.0019		
ddd	0.20			.0078		

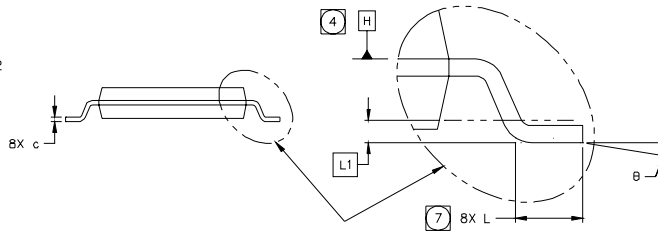

NOTES

1. DIMENSIONING AND TOLERANCING PER ASME Y14.5M-1994.
2. DIMENSIONS ARE SHOWN IN MILLIMETERS AND INCHES.
3. CONTROLLING DIMENSION: MILLIMETER.
4. DATUM PLANE H IS LOCATED AS SHOWN.
5. DATUM A AND B TO BE DETERMINED AT DATUM PLANE H.
6. DIMENSIONS D AND E1 ARE MEASURED AT DATUM PLANE H.
7. DIMENSION L IS THE LEAD LENGTH FOR SOLDERING TO A SUBSTRATE.
8. OUTLINE CONFORMS TO JEDEC OUTLINE MO-153AA.

LEAD ASSIGNMENTS



Data and specifications subject to change without notice.
This product has been designed and qualified for the consumer market.
Qualification Standards can be found on IR's Web site.

International
IR Rectifier

IR WORLD HEADQUARTERS: 233 Kansas St., El Segundo, California 90245, USA Tel: (310) 252-7105
TAC Fax: (310) 252-7903

Visit us at www.irf.com for sales contact information.05/01