



Chipsmall Limited consists of a professional team with an average of over 10 year of expertise in the distribution of electronic components. Based in Hongkong, we have already established firm and mutual-benefit business relationships with customers from,Europe,America and south Asia,supplying obsolete and hard-to-find components to meet their specific needs.

With the principle of "Quality Parts,Customers Priority,Honest Operation,and Considerate Service",our business mainly focus on the distribution of electronic components. Line cards we deal with include Microchip,ALPS,ROHM,Xilinx,Pulse,ON,Everlight and Freescale. Main products comprise IC,Modules,Potentiometer,IC Socket,Relay,Connector.Our parts cover such applications as commercial,industrial, and automotives areas.

We are looking forward to setting up business relationship with you and hope to provide you with the best service and solution. Let us make a better world for our industry!



Contact us

Tel: +86-755-8981 8866 Fax: +86-755-8427 6832

Email & Skype: info@chipsmall.com Web: www.chipsmall.com

Address: A1208, Overseas Decoration Building, #122 Zhenhua RD., Futian, Shenzhen, China



IRF7905PbF

HEXFET® Power MOSFET

Applications

- Dual SO-8 MOSFET for POL Converters in Notebook Computers, Servers, Graphics Cards, Game Consoles and Set-Top Box

Benefits

- Very Low $R_{DS(on)}$ at 4.5V V_{GS}
- Low Gate Charge
- Fully Characterized Avalanche Voltage and Current
- 20V V_{GS} Max. Gate Rating
- Improved Body Diode Reverse Recovery
- 100% Tested for R_G
- Lead-Free

V_{DSS}	$R_{DS(on)}$ max	I_D
30V	Q1 21.8m Ω @ $V_{GS} = 10V$	7.8A
	Q2 17.1m Ω @ $V_{GS} = 10V$	8.9A

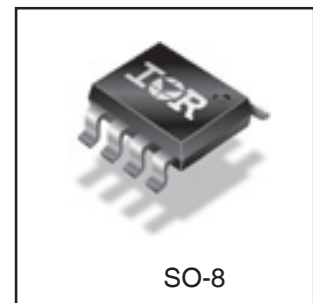
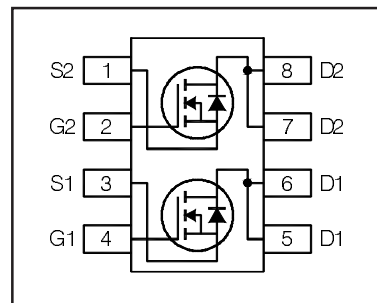

Absolute Maximum Ratings

	Parameter	Q1 Max.	Q2 Max.	Units
V_{DS}	Drain-to-Source Voltage	30		V
V_{GS}	Gate-to-Source Voltage	± 20		
$I_D @ T_A = 25^\circ C$	Continuous Drain Current, $V_{GS} @ 10V$	7.8	8.9	A
$I_D @ T_A = 70^\circ C$	Continuous Drain Current, $V_{GS} @ 10V$	6.2	7.1	
I_{DM}	Pulsed Drain Current ①	62	71	
$P_D @ T_A = 25^\circ C$	Power Dissipation	2.0	2.0	W
$P_D @ T_A = 70^\circ C$	Power Dissipation	1.3	1.3	
	Linear Derating Factor	0.016	0.016	W/ $^\circ C$
T_J T_{STG}	Operating Junction and Storage Temperature Range	-55 to + 150		$^\circ C$

Thermal Resistance

	Parameter	Q1 Max.	Q2 Max.	Units
$R_{\theta JL}$	Junction-to-Drain Lead ⑤	42	42	$^\circ C/W$
$R_{\theta JA}$	Junction-to-Ambient ④⑤	62.5	62.5	

IRF7905PbF

Static @ T_J = 25°C (unless otherwise specified)

International
IR Rectifier

	Parameter		Min.	Typ.	Max.	Units	Conditions
BV _{DSS}	Drain-to-Source Breakdown Voltage	Q1&Q2	30	—	—	V	V _{GS} = 0V, I _D = 250μA
ΔBV _{DSS} /ΔT _J	Breakdown Voltage Temp. Coefficient	Q1	—	0.024	—	V/°C	Reference to 25°C, I _D = 1mA
		Q2	—	0.024	—		
R _{DS(on)}	Static Drain-to-Source On-Resistance	Q1	—	17.4	21.8	mΩ	V _{GS} = 10V, I _D = 7.8A ③
			—	23.4	29.3		V _{GS} = 4.5V, I _D = 6.2A ③
		Q2	—	13.7	17.1		V _{GS} = 10V, I _D = 8.9A ③
			—	17.1	21.3		V _{GS} = 4.5V, I _D = 7.1A ③
V _{GS(th)}	Gate Threshold Voltage	Q1&Q2	1.35	1.8	2.25	V	V _{DS} = V _{GS} , I _D = 25μA
ΔV _{GS(th)} /ΔT _J	Gate Threshold Voltage Coefficient	Q1	—	-5.0	—	mV/°C	
		Q2	—	-5.0	—		
I _{DSS}	Drain-to-Source Leakage Current	Q1&Q2	—	—	1.0	μA	V _{DS} = 24V, V _{GS} = 0V
		Q1&Q2	—	—	150		V _{DS} = 24V, V _{GS} = 0V, T _J = 125°C
I _{GSS}	Gate-to-Source Forward Leakage	Q1&Q2	—	—	100	nA	V _{GS} = 20V
	Gate-to-Source Reverse Leakage	Q1&Q2	—	—	-100		V _{GS} = -20V
gfs	Forward Transconductance	Q1	15	—	—	S	V _{DS} = 15V, I _D = 6.2A
		Q2	18	—	—		V _{DS} = 15V, I _D = 7.1A
Q _g	Total Gate Charge	Q1	—	4.6	6.9		
		Q2	—	6.9	10		
Q _{gs1}	Pre-V _{th} Gate-to-Source Charge	Q1	—	0.9	—		Q1 V _{DS} = 15V V _{GS} = 4.5V, I _D = 6.2A
		Q2	—	1.5	—		
Q _{gs2}	Post-V _{th} Gate-to-Source Charge	Q1	—	0.6	—		
		Q2	—	0.8	—		
Q _{gd}	Gate-to-Drain Charge	Q1	—	1.7	—		Q2 V _{DS} = 15V V _{GS} = 4.5V, I _D = 7.1A
		Q2	—	2.5	—		
Q _{godr}	Gate Charge Overdrive	Q1	—	1.4	—		
		Q2	—	2.1	—		
Q _{sw}	Switch Charge (Q _{gs2} + Q _{gd})	Q1	—	2.3	—		
		Q2	—	3.3	—		
Q _{oss}	Output Charge	Q1	—	2.9	—	nC	V _{DS} = 16V, V _{GS} = 0V
		Q2	—	4.5	—		
R _G	Gate Resistance	Q1	—	3.1	4.9	Ω	
		Q2	—	3.1	4.9		
t _{d(on)}	Turn-On Delay Time	Q1	—	5.2	—		Q1 V _{DD} = 15V, V _{GS} = 4.5V I _D = 6.2A
		Q2	—	6.2	—		
t _r	Rise Time	Q1	—	8.3	—	ns	
		Q2	—	9.3	—		
t _{d(off)}	Turn-Off Delay Time	Q1	—	6.9	—		Q2 V _{DD} = 15V, V _{GS} = 4.5V I _D = 7.1A Clamped Inductive Load
		Q2	—	8.1	—		
t _f	Fall Time	Q1	—	3.4	—		
		Q2	—	3.4	—		
C _{iss}	Input Capacitance	Q1	—	600	—	pF	V _{GS} = 0V V _{DS} = 15V f = 1.0MHz
		Q2	—	910	—		
C _{oss}	Output Capacitance	Q1	—	130	—		
		Q2	—	190	—		
C _{rss}	Reverse Transfer Capacitance	Q1	—	78	—		
		Q2	—	95	—		

Avalanche Characteristics

	Parameter	Typ.	Q1 Max.	Q2 Max.	Units
E _{AS}	Single Pulse Avalanche Energy ①	—	12	18	mJ
I _{AR}	Avalanche Current ①	—	6.2	7.1	A

Diode Characteristics

	Parameter		Min.	Typ.	Max.	Units	Conditions
I _S	Continuous Source Current (Body Diode)	Q1	—	—	2.8	A	MOSFET symbol showing the integral reverse p-n junction diode.
		Q2	—	—	2.8		
I _{SM}	Pulsed Source Current (Body Diode) ①	Q1	—	—	62	A	
		Q2	—	—	71		
V _{SD}	Diode Forward Voltage	Q1	—	—	1.0	V	T _J = 25°C, I _S = 6.1A, V _{GS} = 0V ③
		Q2	—	—	1.0		T _J = 25°C, I _S = 7.1A, V _{GS} = 0V ③
t _{rr}	Reverse Recovery Time	Q1	—	10	15	ns	Q1 T _J = 25°C, I _F = 6.2A, V _{DD} = 15V, di/dt = 100A/μs ③
		Q2	—	13	20		
Q _{rr}	Reverse Recovery Charge	Q1	—	2.5	3.8	nC	Q2 T _J = 25°C, I _F = 7.1A, V _{DD} = 15V, di/dt = 100A/μs ③
		Q2	—	4.0	6.0		

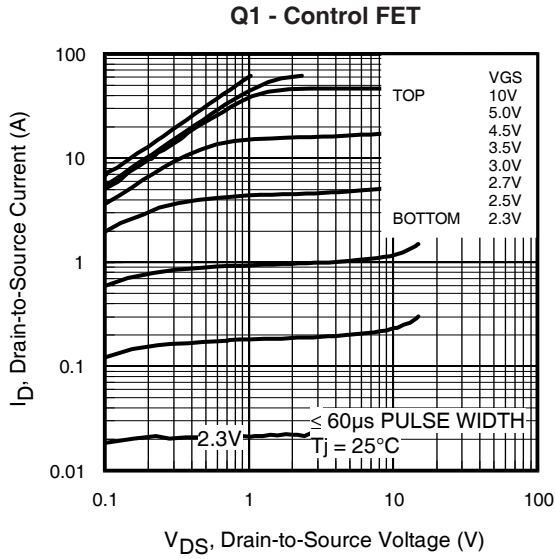

Fig 1. Typical Output Characteristics

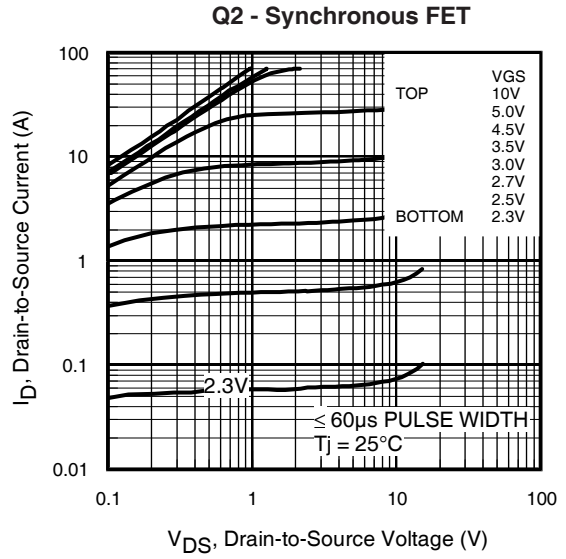

Fig 2. Typical Output Characteristics

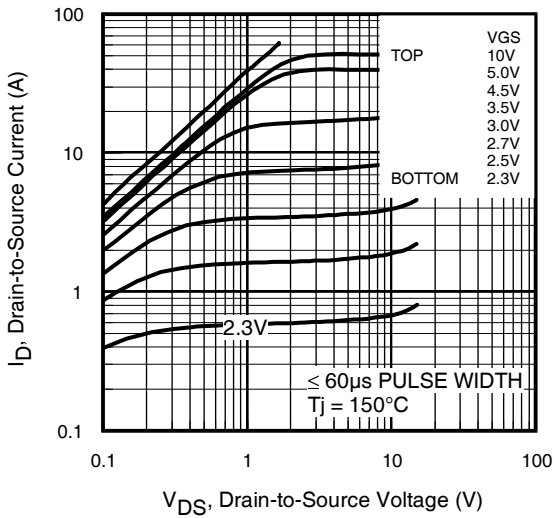

Fig 3. Typical Output Characteristics

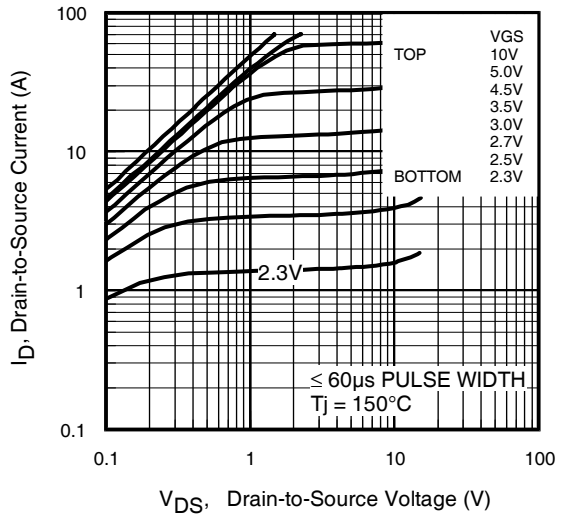

Fig 4. Typical Output Characteristics

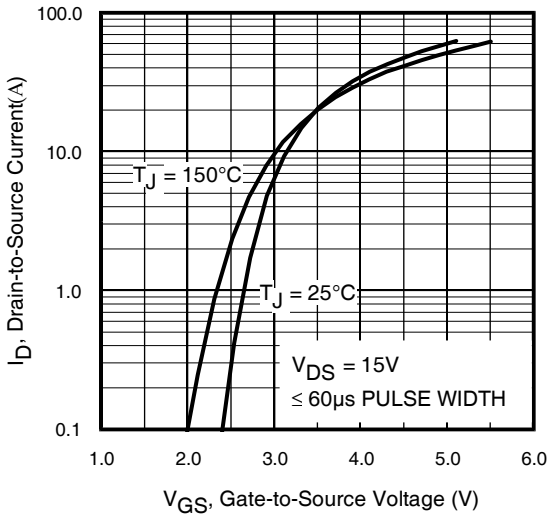

Fig 5. Typical Transfer Characteristics

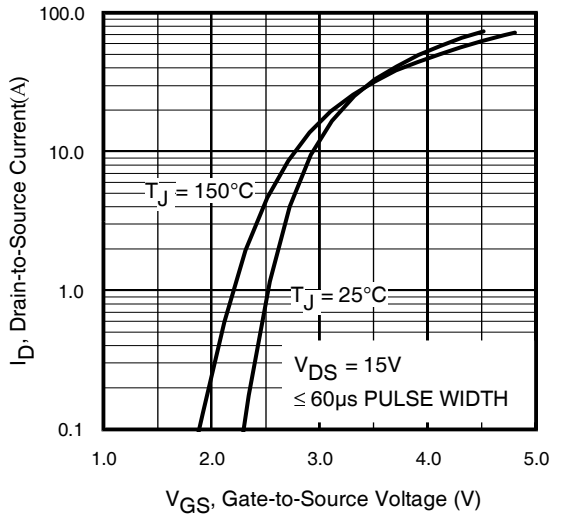

Fig 6. Typical Transfer Characteristics

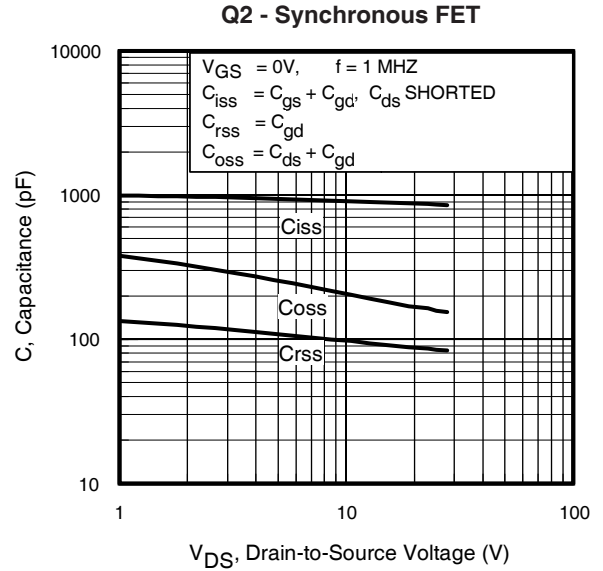
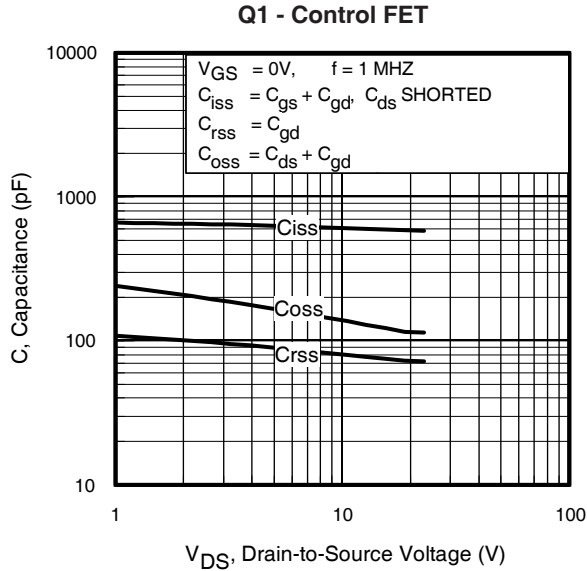

Fig 7. Typical Capacitance vs. Drain-to-Source Voltage **Fig 8.** Typical Capacitance vs. Drain-to-Source Voltage

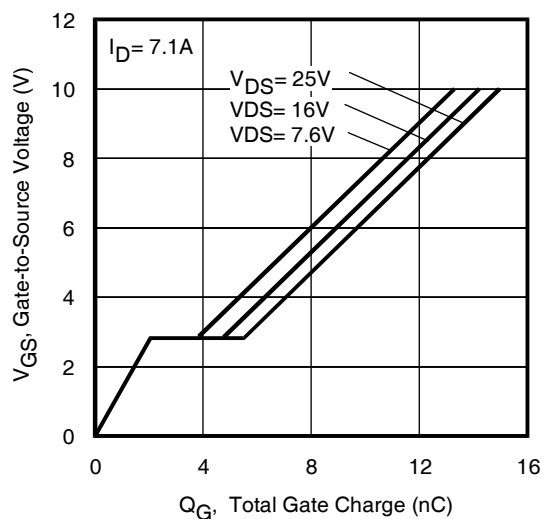
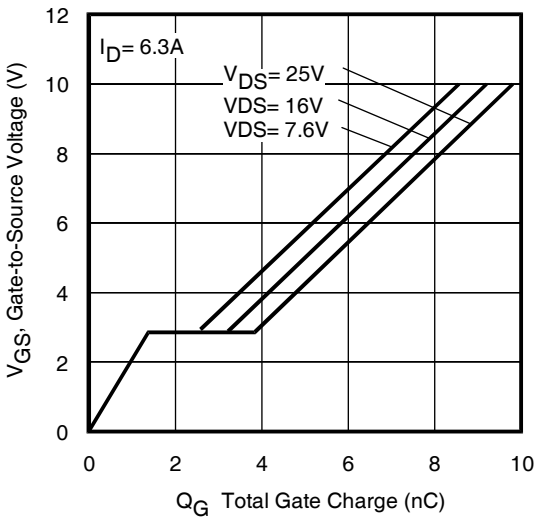

Fig 9. Typical Gate Charge vs. Gate-to-Source Voltage

Fig 10. Typical Gate Charge vs. Gate-to-Source Voltage

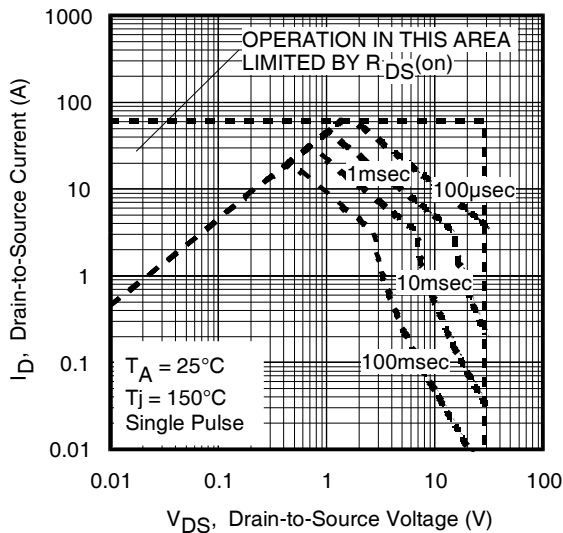

Fig 11. Maximum Safe Operating Area

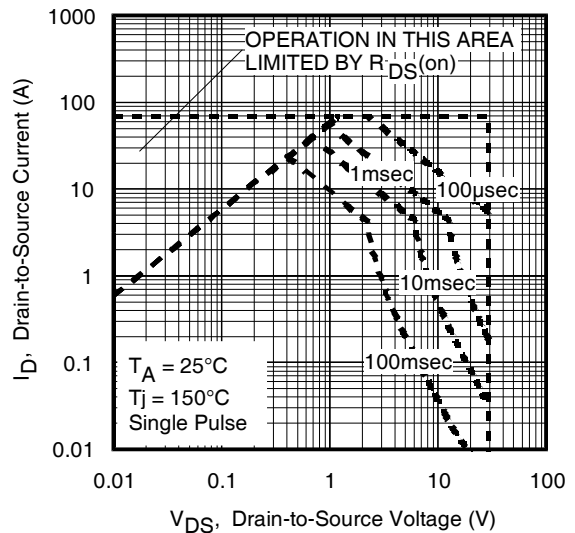

Fig 12. Maximum Safe Operating Area

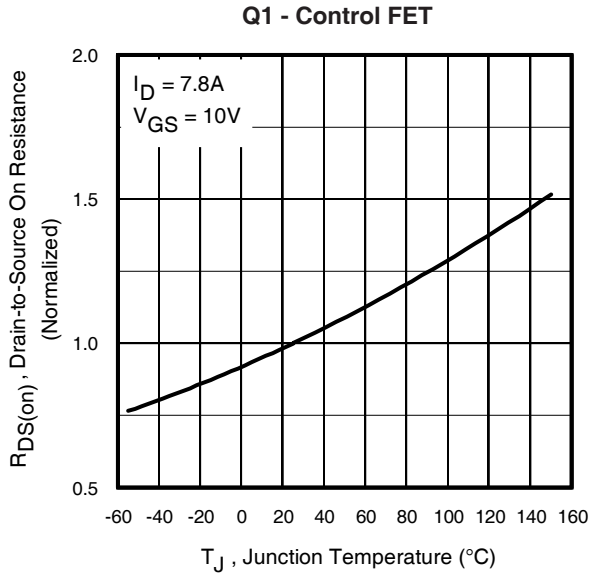

Fig 13. Normalized On-Resistance vs. Temperature

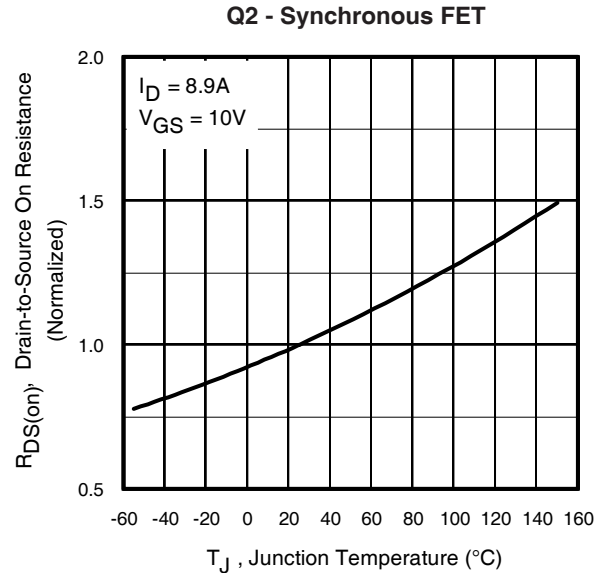

Fig 14. Normalized On-Resistance vs. Temperature

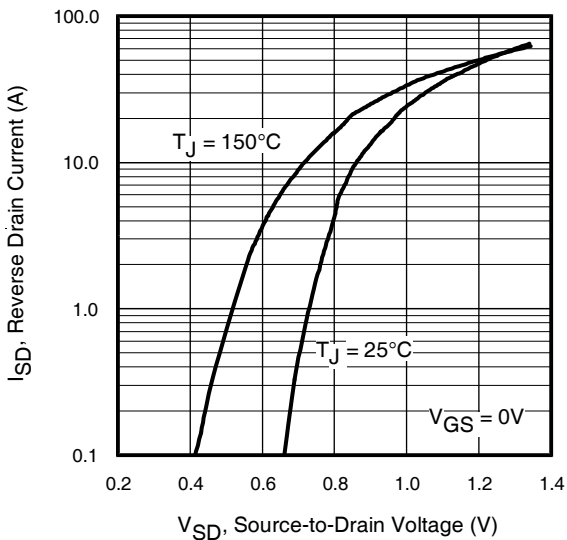

Fig 15. Typical Source-Drain Diode Forward Voltage

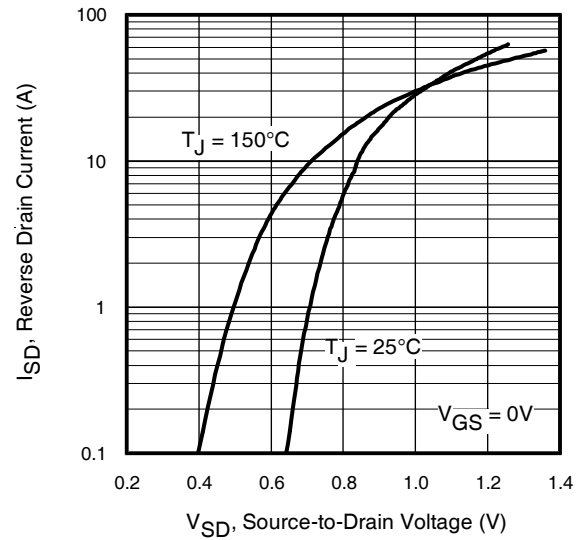

Fig 16. Typical Source-Drain Diode Forward Voltage

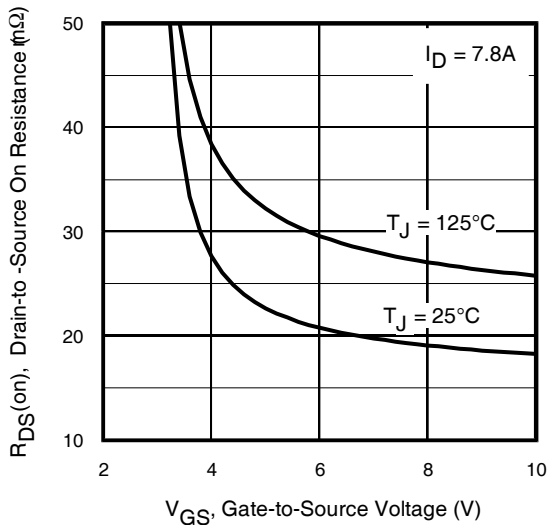

Fig 17. Typical On-Resistance vs. Gate Voltage

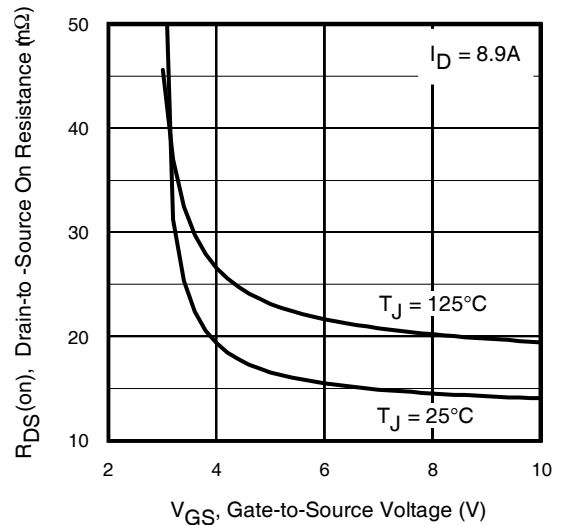

Fig 18. Typical On-Resistance vs. Gate Voltage

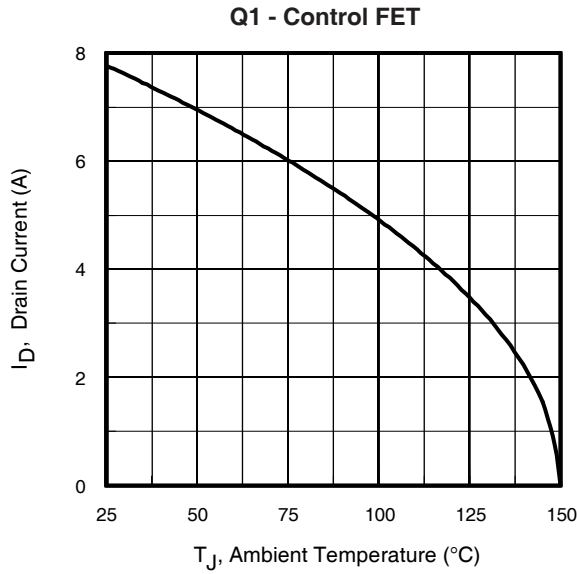

Fig 19. Maximum Drain Current vs. Ambient Temp.

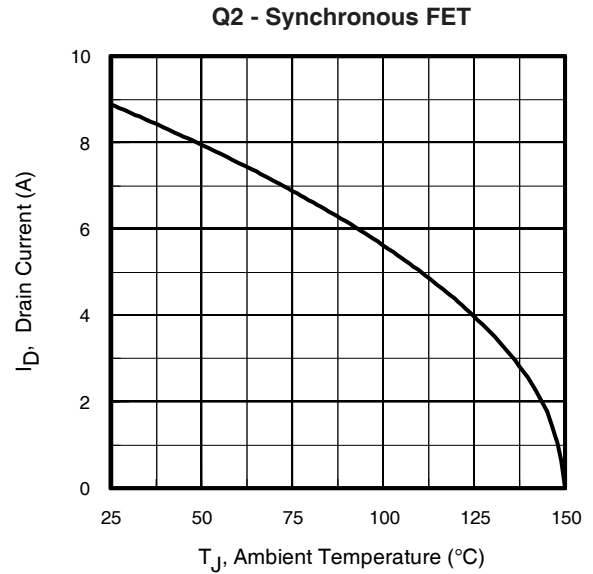

Fig 20. Maximum Drain Current vs. Ambient Temp.

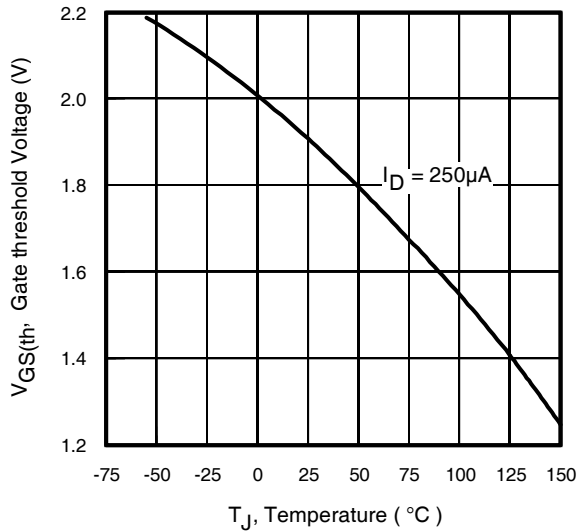

Fig 21. Threshold Voltage vs. Temperature

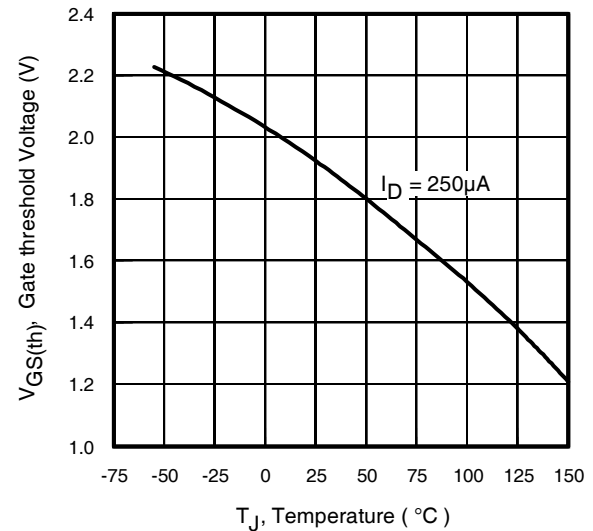

Fig 22. Threshold Voltage vs. Temperature

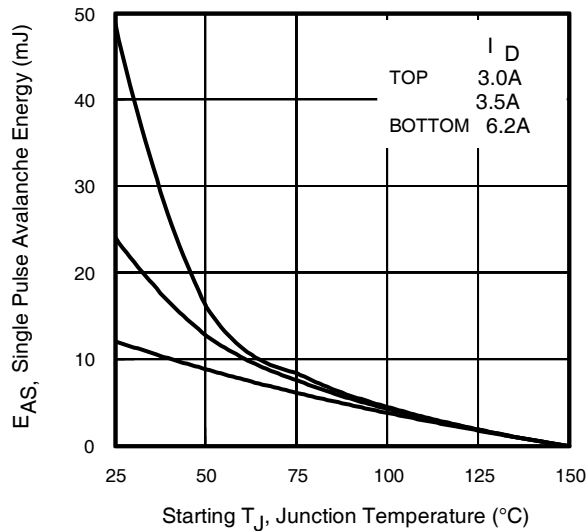

Fig 23. Maximum Avalanche Energy vs. Drain Current

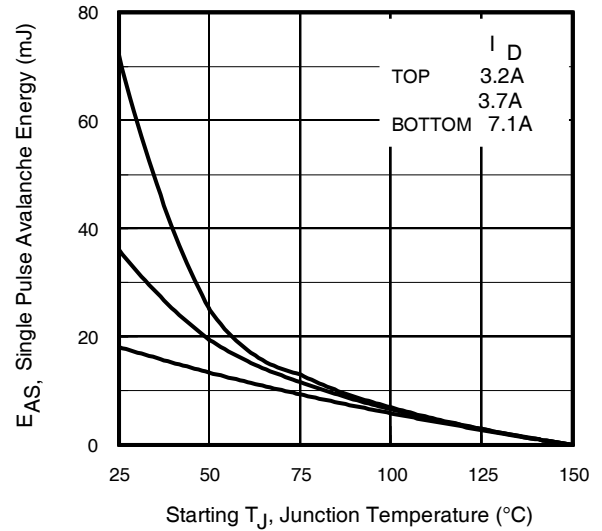

Fig 24. Maximum Avalanche Energy vs. Drain Current

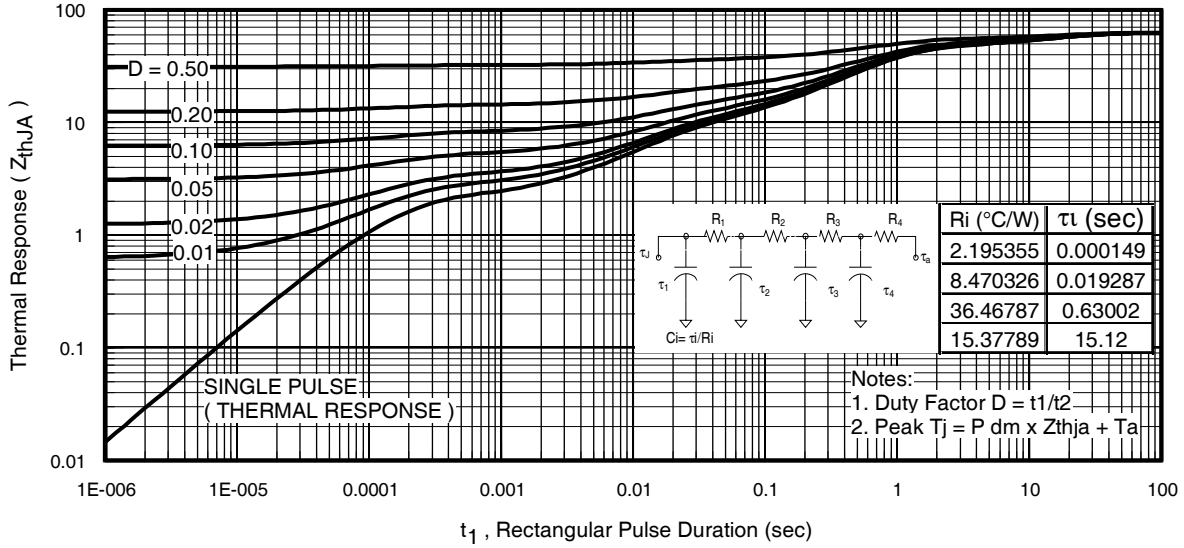

Fig 25. Maximum Effective Transient Thermal Impedance, Junction-to-Ambient (Q1)

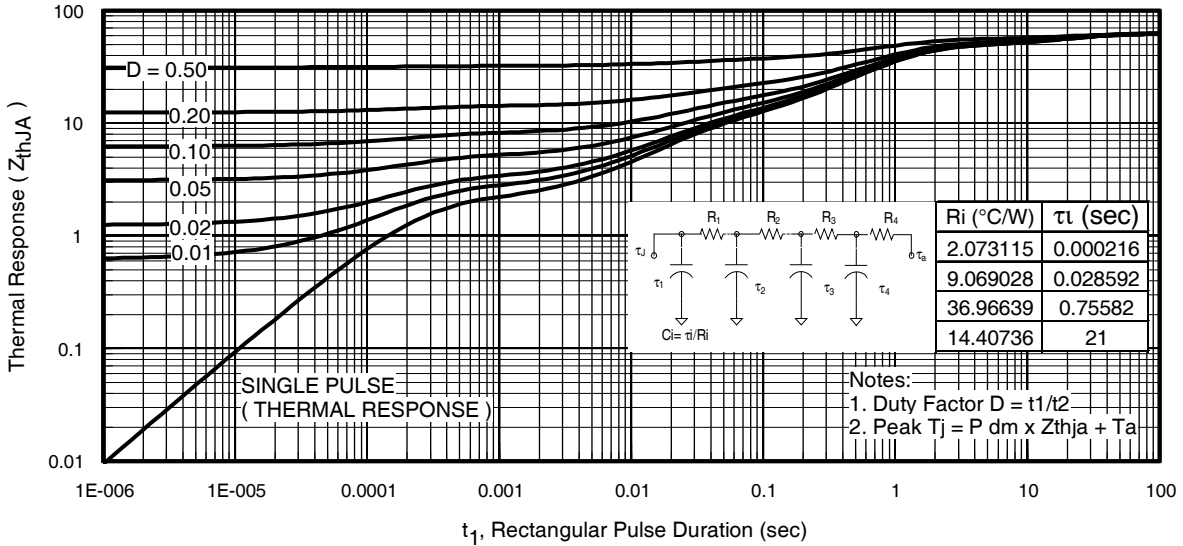

Fig 26. Maximum Effective Transient Thermal Impedance, Junction-to-Ambient (Q2)

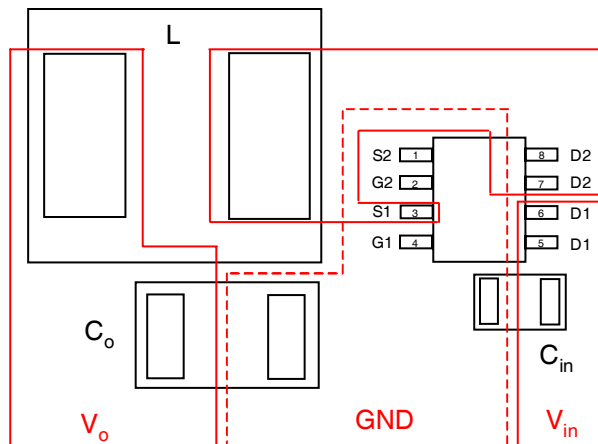

Fig 27. Layout Diagram

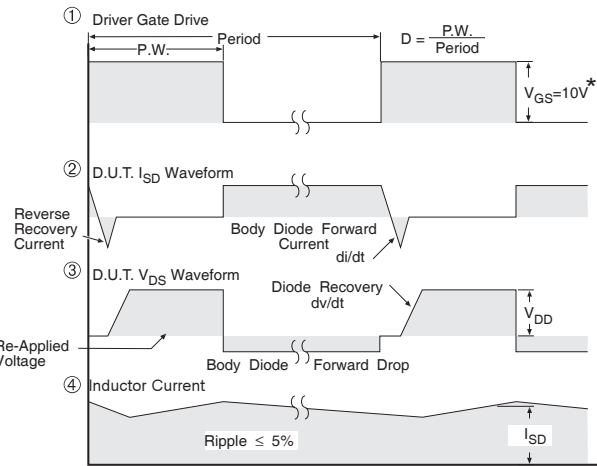
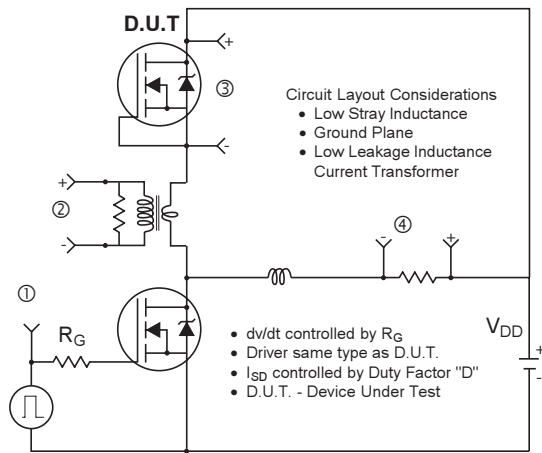

Fig 28. Peak Diode Recovery dv/dt Test Circuit for N-Channel HEXFET[®] Power MOSFETs

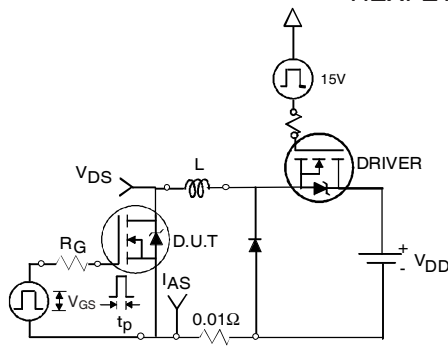

Fig 29a. Unclamped Inductive Test Circuit

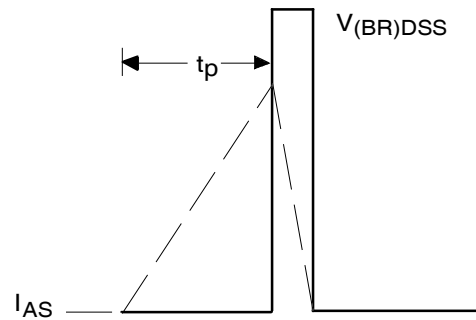

Fig 29b. Unclamped Inductive Waveforms

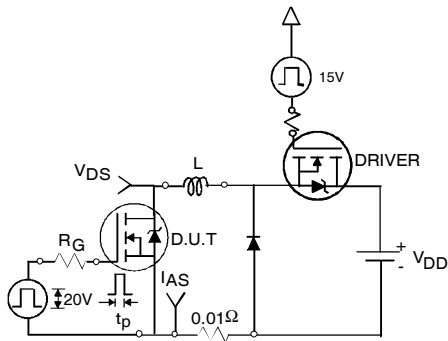

Fig 30a. Switching Time Test Circuit

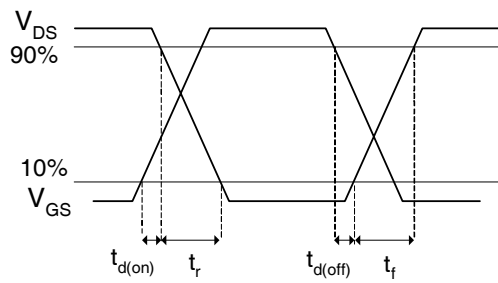

Fig 30b. Switching Time Waveforms

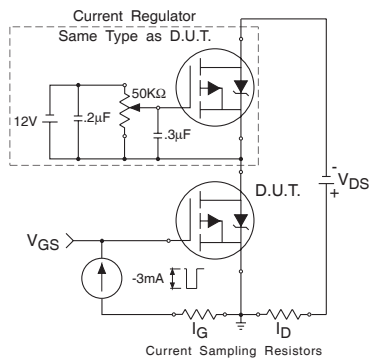

Fig 31a. Gate Charge Test Circuit

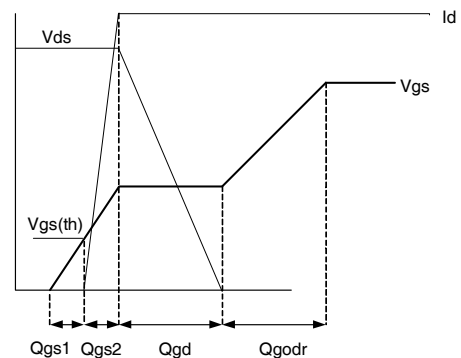
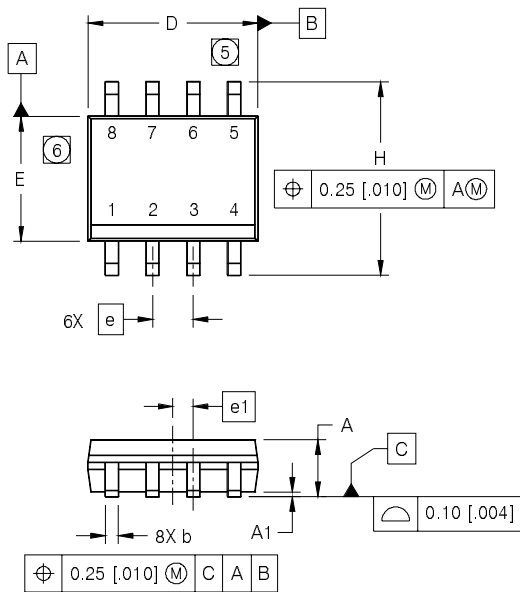

Fig 31b. Gate Charge Waveform

SO-8 Package Outline (MOSFET & Fetky)

Dimensions are shown in millimeters (inches)



DIM	INCHES		MILLIMETERS	
	MIN	MAX	MIN	MAX
A	.0532	.0688	1.35	1.75
A1	.0040	.0098	0.10	0.25
b	.013	.020	0.33	0.51
c	.0075	.0098	0.19	0.25
D	.189	.1968	4.80	5.00
E	.1497	.1574	3.80	4.00
e	.050 BASIC		1.27 BASIC	
e 1	.025 BASIC		0.635 BASIC	
H	.2284	.2440	5.80	6.20
K	.0099	.0196	0.25	0.50
L	.016	.050	0.40	1.27
y	0°	8°	0°	8°

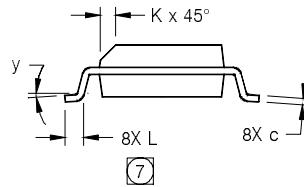

NOTES:

1. DIMENSIONING & TOLERANCING PER ASME Y14.5M-1994.
2. CONTROLLING DIMENSION: MILLIMETER
3. DIMENSIONS ARE SHOWN IN MILLIMETERS [INCHES].
4. OUTLINE CONFORMS TO JEDEC OUTLINE MS-012AA.
5. DIMENSION DOES NOT INCLUDE MOLD PROTRUSIONS. MOLD PROTRUSIONS NOT TO EXCEED 0.15 [0.006].
6. DIMENSION DOES NOT INCLUDE MOLD PROTRUSIONS. MOLD PROTRUSIONS NOT TO EXCEED 0.25 [0.010].
7. DIMENSION IS THE LENGTH OF LEAD FOR SOLDERING TO A SUBSTRATE.

FOOTPRINT

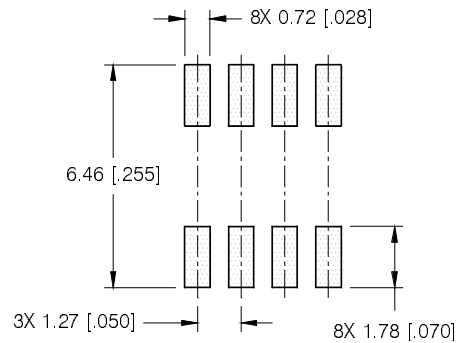

SO-8 Part Marking Information

EXAMPLE: THIS IS AN IRF7101 (MOSFET)

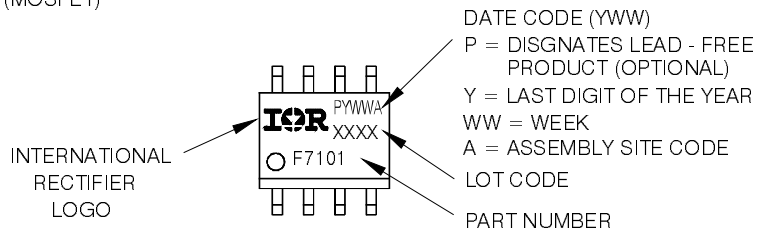

Note: For the most current drawing please refer to IR website at: <http://www.irf.com/package/>

IRF7905PbF

SO-8 Tape and Reel

Dimensions are shown in millimeters (inches)

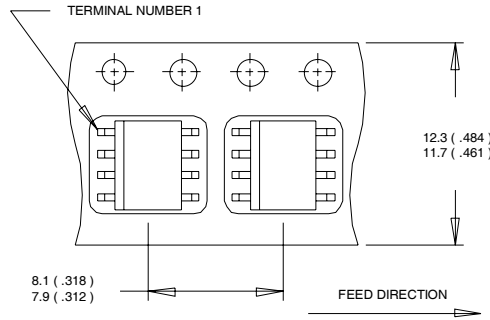

- NOTES:
1. CONTROLLING DIMENSION : MILLIMETER.
 2. ALL DIMENSIONS ARE SHOWN IN MILLIMETERS(INCHES).
 3. OUTLINE CONFORMS TO EIA-481 & EIA-541.

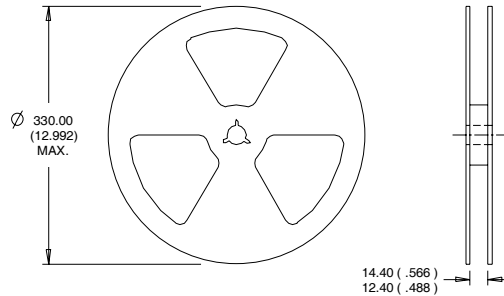

- NOTES :
1. CONTROLLING DIMENSION : MILLIMETER.
 2. OUTLINE CONFORMS TO EIA-481 & EIA-541.

Note: For the most current drawing please refer to IR website at: <http://www.irf.com/package/>

Notes:

- ① Repetitive rating; pulse width limited by max. junction temperature.
- ② Starting $T_J = 25^\circ\text{C}$, Q1: $L = 0.62\text{mH}$
 $R_G = 25\Omega$, $I_{AS} = 6.2\text{A}$; Q2: $L = 0.72\text{mH}$
 $R_G = 25\Omega$, $I_{AS} = 7.1\text{A}$.
- ③ Pulse width $\leq 400\mu\text{s}$; duty cycle $\leq 2\%$.
- ④ When mounted on 1 inch square copper board.
- ⑤ R_θ is measured at T_J approximately 90°C .

Data and specifications subject to change without notice.
This product has been designed and qualified for the Consumer market.
Qualification Standards can be found on IR's Web site.