



Chipsmall Limited consists of a professional team with an average of over 10 year of expertise in the distribution of electronic components. Based in Hongkong, we have already established firm and mutual-benefit business relationships with customers from,Europe,America and south Asia,supplying obsolete and hard-to-find components to meet their specific needs.

With the principle of “Quality Parts,Customers Priority,Honest Operation,and Considerate Service”,our business mainly focus on the distribution of electronic components. Line cards we deal with include Microchip,ALPS,ROHM,Xilinx,Pulse,ON,Everlight and Freescale. Main products comprise IC,Modules,Potentiometer,IC Socket,Relay,Connector.Our parts cover such applications as commercial,industrial, and automotives areas.

We are looking forward to setting up business relationship with you and hope to provide you with the best service and solution. Let us make a better world for our industry!



Contact us

Tel: +86-755-8981 8866 Fax: +86-755-8427 6832

Email & Skype: info@chipsmall.com Web: www.chipsmall.com

Address: A1208, Overseas Decoration Building, #122 Zhenhua RD., Futian, Shenzhen, China



	N-CH	P-CH	
V_{DS}	30	-30	V
$R_{DS(on) \max}$	27	64	m Ω
Q_g (typical)	6.8	8.1	nC
I_D (@ $T_A = 25^\circ\text{C}$)	6.8	-4.6	A

HEXFET® Power MOSFET

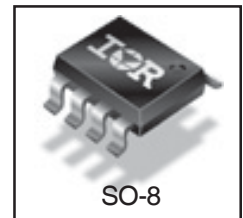
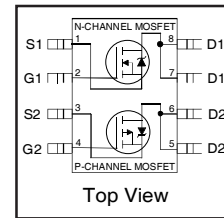

Applications

- High and Low Side Switches for Inverter
- High and Low Side Switches for Generic Half-Bridge

Features

High and low-side MOSFETs in a single package
High-side P-Channel MOSFET
Industry-standard pinout
Compatible with existing surface mount techniques
RoHS compliant containing no Lead, no Bromide and no Halogen
MSL1, Consumer qualification

results in
 \Rightarrow

Benefits

Increased power density
Easier drive circuitry
Multi-vendor compatibility
Easier manufacturing
Environmentally friendlier
Increased reliability

Base Part Number	Package Type	Standard Pack		Orderable part number
		Form	Quantity	
IRF9389PbF	SO-8	Tube/Bulk	95	IRF9389PbF
		Tape and Reel	4000	IRF9389TRPbF

Absolute Maximum Ratings

	Parameter	Max.		Units
		N-Channel	P-Channel	
V_{GS}	Gate-to-Source Voltage	± 20	± 20	V
$I_D @ T_A = 25^\circ\text{C}$	Continuous Drain Current, $V_{GS} @ 10\text{V}$	6.8	-4.6	A
$I_D @ T_A = 70^\circ\text{C}$	Continuous Drain Current, $V_{GS} @ 10\text{V}$	5.4	-3.7	
I_{DM}	Pulsed Drain Current ①	34	-23	
$P_D @ T_A = 25^\circ\text{C}$	Power Dissipation	2.0		W
$P_D @ T_A = 70^\circ\text{C}$	Power Dissipation	1.3		
	Linear Derating Factor	0.016		
T_J T_{STG}	Operating Junction and Storage Temperature Range	-55 to + 150		$^\circ\text{C}$

Thermal Resistance

	Parameter	Typ.	Max	Units
$R_{\theta JL}$	Junction-to-Drain Lead ④	—	20	$^\circ\text{C/W}$
$R_{\theta JA}$	Junction-to-Ambient ③	—	62.5	

Static @ T_J = 25°C (unless otherwise specified)

	Parameter		Min.	Typ.	Max.	Units	Conditions
BV _{DSS}	Drain-to-Source Breakdown Voltage	N-Ch	30	—	—	V	V _{GS} = 0V, I _D = 250μA
		P-Ch	-30	—	—		V _{GS} = 0V, I _D = -250μA
ΔBV _{DSS} /ΔT _J	Breakdown Voltage Temp. Coefficient	N-Ch	—	0.03	—	V/°C	Reference to 25°C, I _D = 1mA
		P-Ch	—	0.02	—		Reference to 25°C, I _D = -1mA
R _{DS(on)}	Static Drain-to-Source On-Resistance	N-Ch	—	22	27	mΩ	V _{GS} = 10V, I _D = 6.8A ②
			—	33	40		V _{GS} = 4.5V, I _D = 5.4A ②
		P-Ch	—	51	64	mΩ	V _{GS} = -10V, I _D = -4.6A ②
			—	82	103		V _{GS} = -4.5V, I _D = -3.7A ②
V _{GS(th)}	Gate Threshold Voltage	N-Ch	1.3	1.8	2.3	V	V _{DS} = V _{GS} , I _D = 10μA
		P-Ch	-1.3	-1.8	-2.3		V _{DS} = V _{GS} , I _D = -10μA
I _{DSS}	Drain-to-Source Leakage Current	N-Ch	—	—	1.0	μA	V _{DS} = 24V, V _{GS} = 0V
		P-Ch	—	—	-1.0		V _{DS} = -24V, V _{GS} = 0V
		N-Ch	—	—	150		V _{DS} = 24V, V _{GS} = 0V, T _J = 125°C
		P-Ch	—	—	-150		V _{DS} = -24V, V _{GS} = 0V, T _J = 125°C
I _{GSS}	Gate-to-Source Forward Leakage	N-Ch	—	—	100	nA	V _{GS} = 20V
		P-Ch	—	—	-100		V _{GS} = -20V
	Gate-to-Source Reverse Leakage	N-Ch	—	—	-100		V _{GS} = -20V
		P-Ch	—	—	100		V _{GS} = 20V
g _{fs}	Forward Transconductance	N-Ch	8.2	—	—	S	V _{DS} = 15V, I _D = 5.4A
		P-Ch	4.1	—	—		V _{DS} = -15V, I _D = -3.7A
Q _g	Total Gate Charge	N-Ch	—	6.8	14	nC	N-Channel V _{GS} = 10V, V _{DS} = 15V, I _D = 6.8A
		P-Ch	—	8.1	16		P-Channel V _{GS} = -10V, V _{DS} = -15V, I _D = -4.6A
Q _{gs}	Gate-to-Source Charge	N-Ch	—	1.4	—		
		P-Ch	—	1.3	—		
Q _{gd}	Gate-to-Drain ("Miller") Charge	N-Ch	—	0.98	—		
		P-Ch	—	2.1	—		
R _G	Gate Resistance	N-Ch	—	2.2	4.4	Ω	
		P-Ch	—	9.4	19		
t _{d(on)}	Turn-On Delay Time	N-Ch	—	5.1	—	ns	N-Channel V _{DD} = 15V, V _{GS} = 4.5V ③ I _D = 1.0A, R _G = 6.2Ω
		P-Ch	—	8.0	—		
t _r	Rise Time	N-Ch	—	4.8	—		
		P-Ch	—	14	—		
t _{d(off)}	Turn-Off Delay Time	N-Ch	—	4.9	—		P-Channel V _{DD} = -15V, V _{GS} = -4.5V ③ I _D = -1.0A, R _G = 6.8Ω
		P-Ch	—	17	—		
t _f	Fall Time	N-Ch	—	3.9	—		
		P-Ch	—	15	—		
C _{iss}	Input Capacitance	N-Ch	—	398	—	pF	N-Channel V _{GS} = 0V, V _{DS} = 15V, f = 1.0MHz
		P-Ch	—	383	—		
C _{oss}	Output Capacitance	N-Ch	—	82	—		P-Channel V _{GS} = 0V, V _{DS} = -15V, f = 1.0KHz
		P-Ch	—	104	—		
C _{riss}	Reverse Transfer Capacitance	N-Ch	—	36	—		
		P-Ch	—	64	—		

Diode Characteristics

	Parameter		Min.	Typ.	Max.	Units	Conditions
I _S	Continuous Source Current (Body Diode)	N-Ch	—	—	2.0	A	
		P-Ch	—	—	-2.0		
I _{SM}	Pulsed Source Current (Body Diode)	N-Ch	—	—	34		
		P-Ch	—	—	-23		
V _{SD}	Diode Forward Voltage	N-Ch	—	—	1.2	V	T _J = 25°C, I _S = 2.0A, V _{GS} = 0V ③
		P-Ch	—	—	-1.2		T _J = 25°C, I _S = -2.0A, V _{GS} = 0V ③
t _{rr}	Reverse Recovery Time	N-Ch	—	8.4	13	ns	N-Channel: T _J = 25°C, I _F = 2.0A, V _{DD} = 15V, di/dt = 102/μs ④
		P-Ch	—	11	17		
Q _{rr}	Reverse Recovery Charge	N-Ch	—	2.3	3.5	nC	P-Channel: T _J = 25°C, I _F = -2.0A, V _{DD} = -15V, di/dt = 102/μs ④
		P-Ch	—	4.8	7.2		

Notes:

- ① Repetitive rating; pulse width limited by max. junction temperature. (See fig. 16)
 ② Pulse width ≤ 400μs; duty cycle ≤ 2%.

- ③ Surface mounted on 1 in square Cu board
 ④ R_θ is measured at T_J approximately 90°C

N-Channel

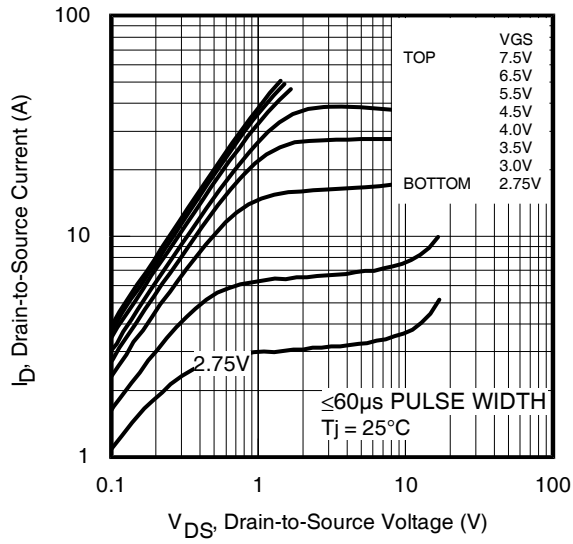

Fig 1. Typical Output Characteristics

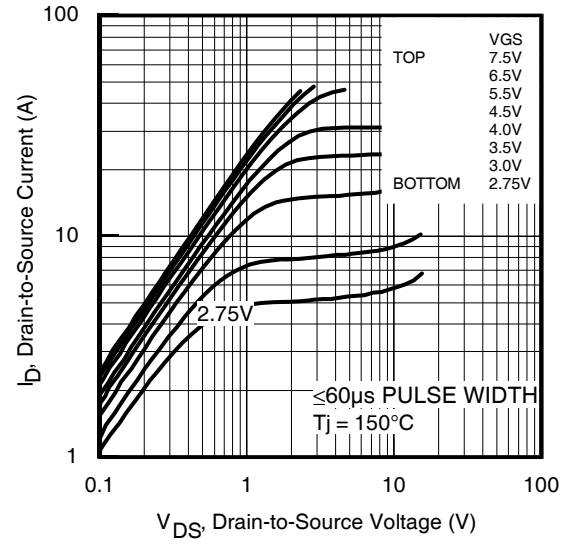

Fig 2. Typical Output Characteristics

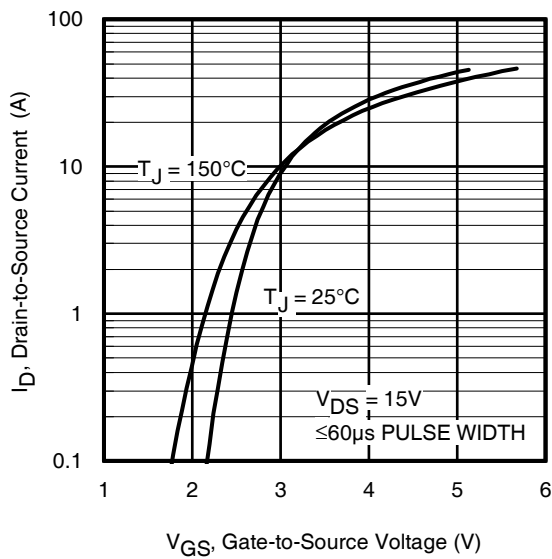

Fig 3. Typical Transfer Characteristics

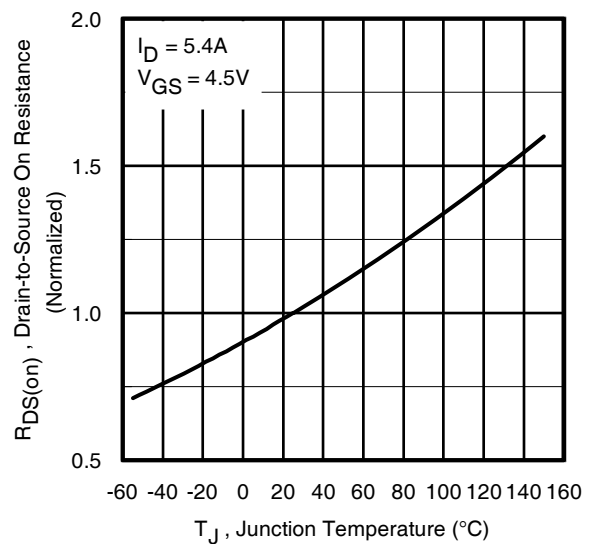
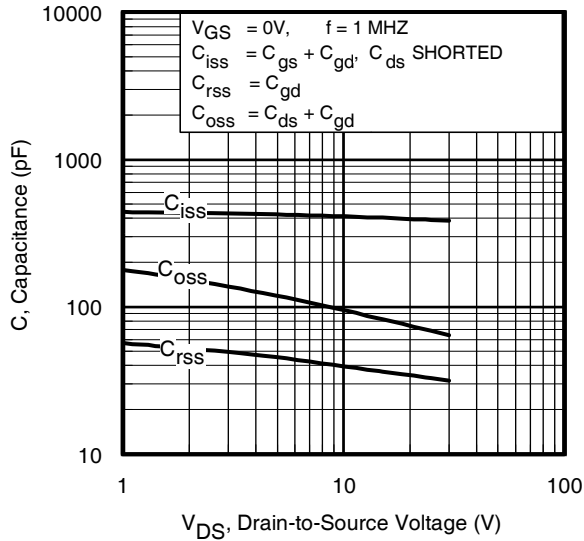
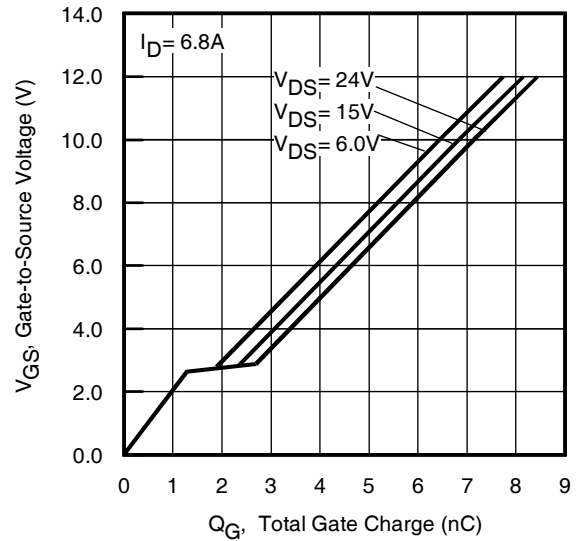
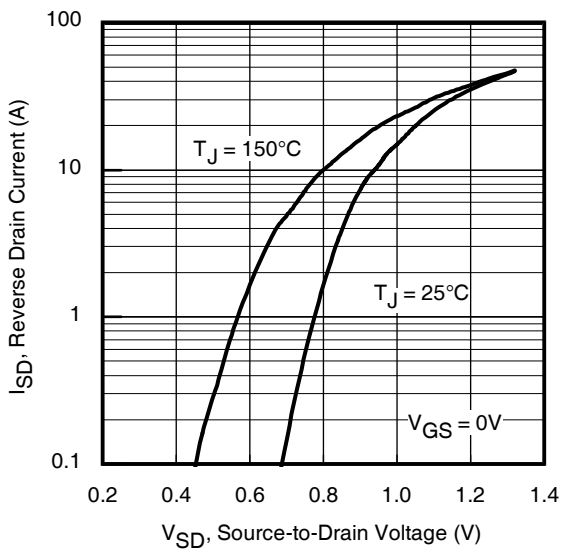
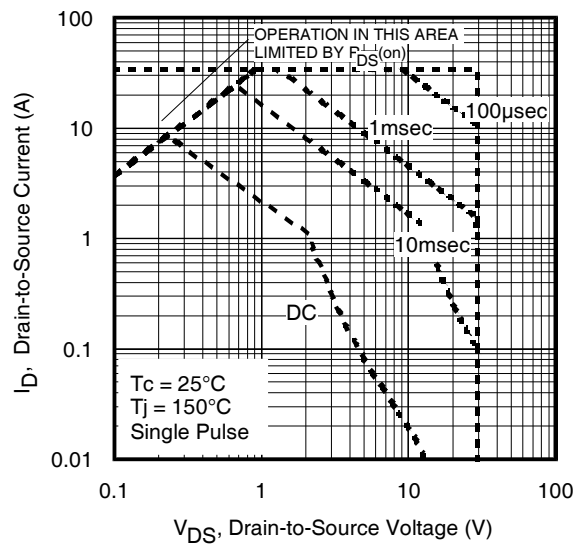
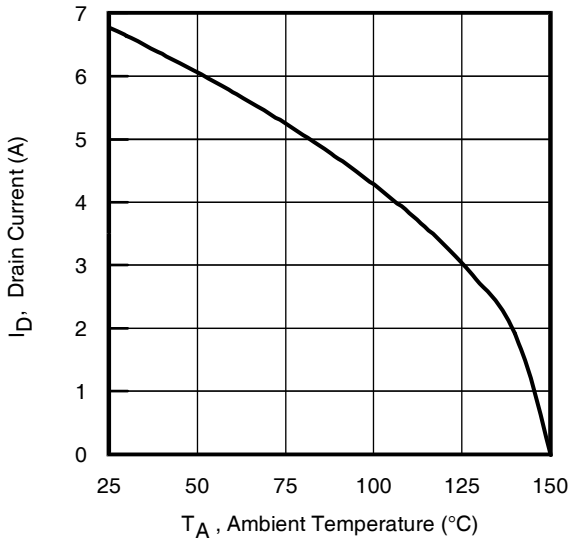
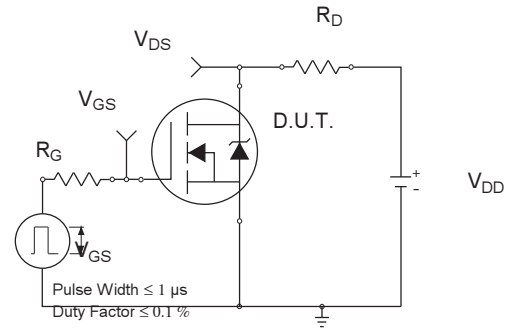
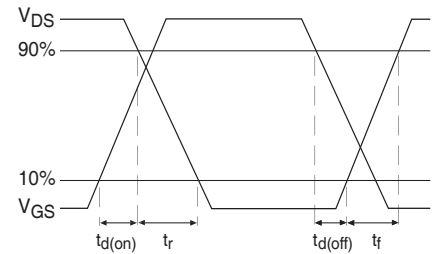
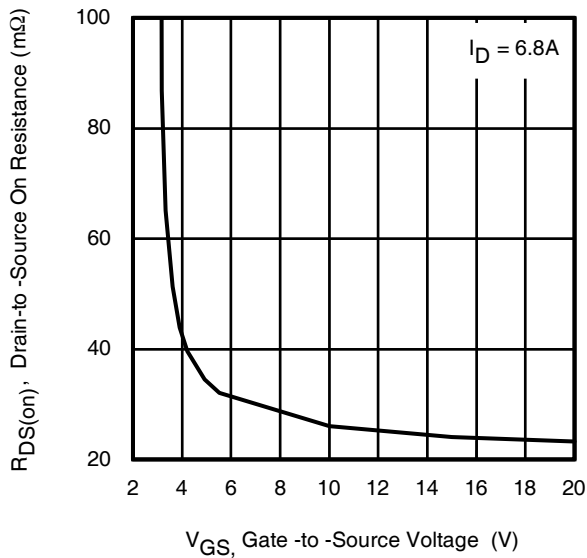
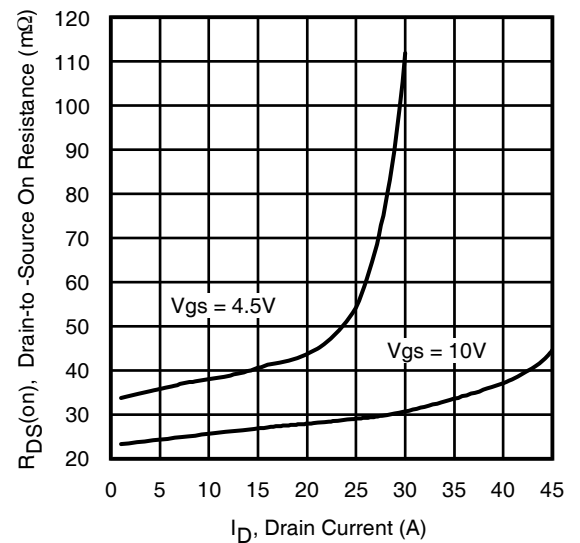

Fig 4. Normalized On-Resistance vs. Temperature

N-Channel

Fig 5. Typical Capacitance vs. Drain-to-Source Voltage

Fig 6. Typical Gate Charge vs. Gate-to-Source Voltage

Fig 7. Typical Source-Drain Diode Forward Voltage

Fig 8. Maximum Safe Operating Area

N-Channel

Fig 9. Maximum Drain Current vs. Ambient Temperature

Fig 10a. Switching Time Test Circuit

Fig 10b. Switching Time Waveforms

Fig 11. Typical On-Resistance vs. Gate Voltage

Fig 12. Typical On-Resistance vs. Drain Current

N-Channel

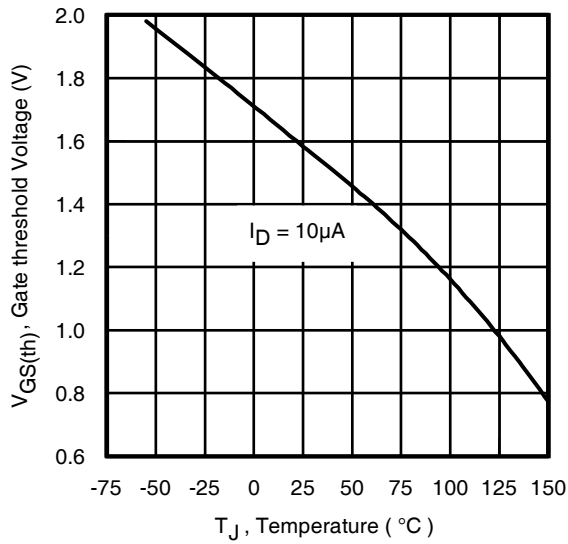

Fig 13. Threshold Voltage vs. Temperature

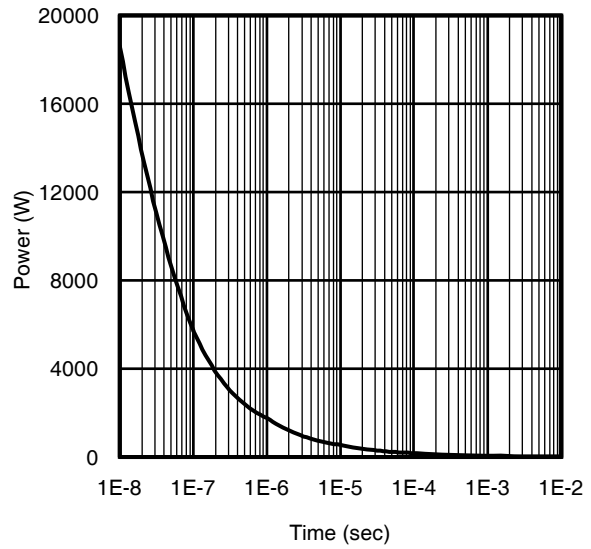

Fig 14. Typical Power vs. Time

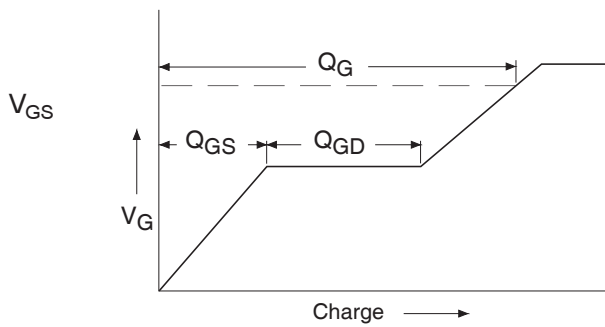

Fig 15a. Basic Gate Charge Waveform

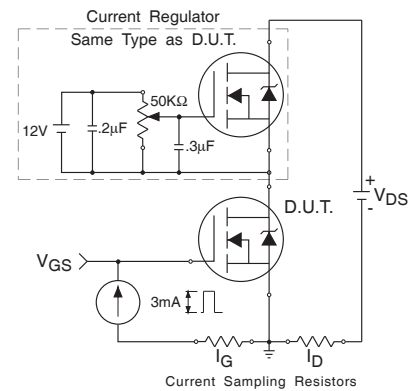

Fig 15b. Gate Charge Test Circuit

N and P-Channel

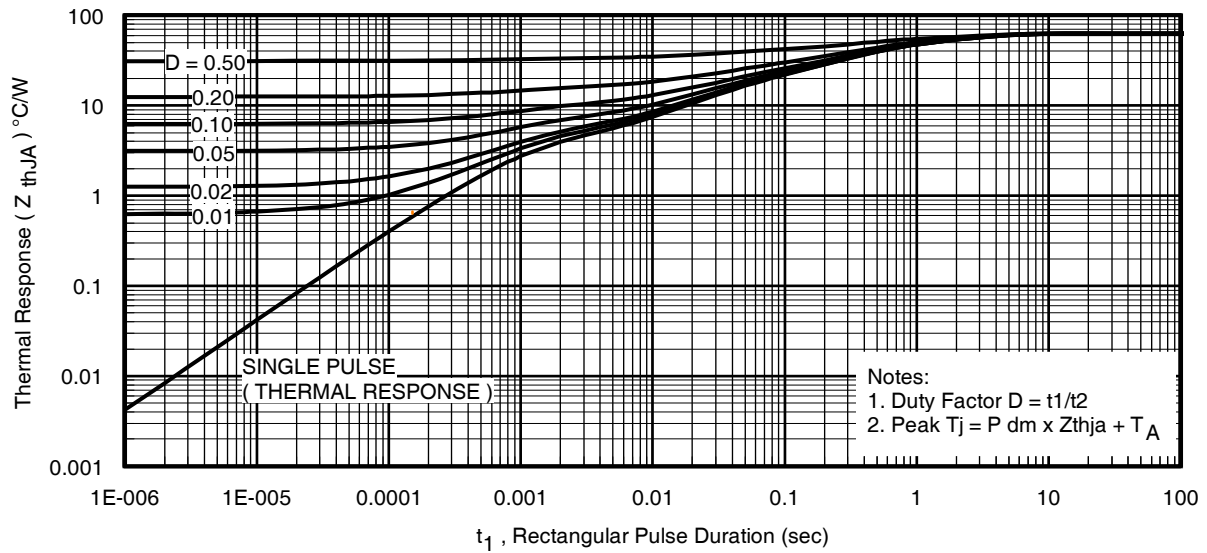

Fig 16. Typical Effective Transient Thermal Impedance, Junction-to-Ambient

P-Channel

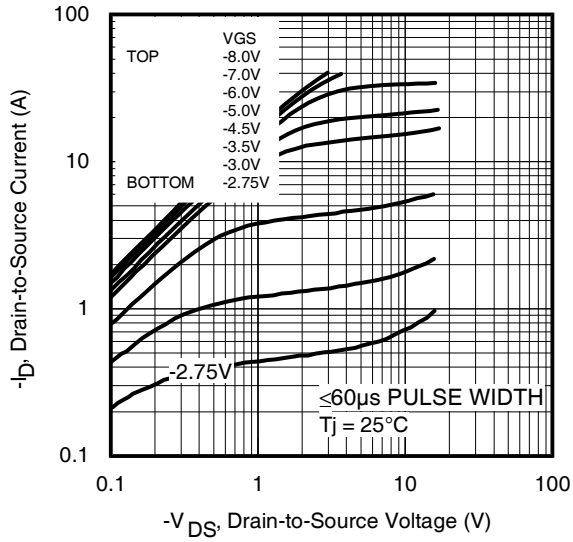

Fig 17. Typical Output Characteristics

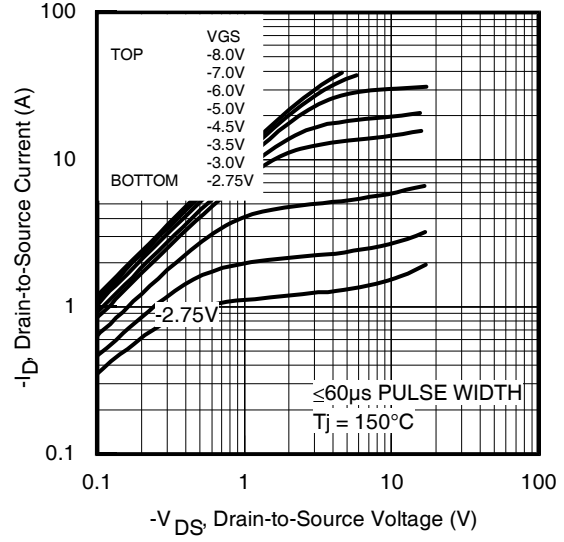

Fig 18. Typical Output Characteristics

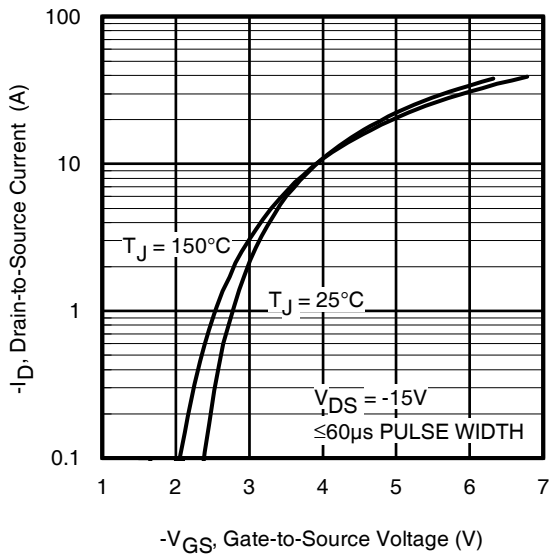

Fig 19. Typical Transfer Characteristics

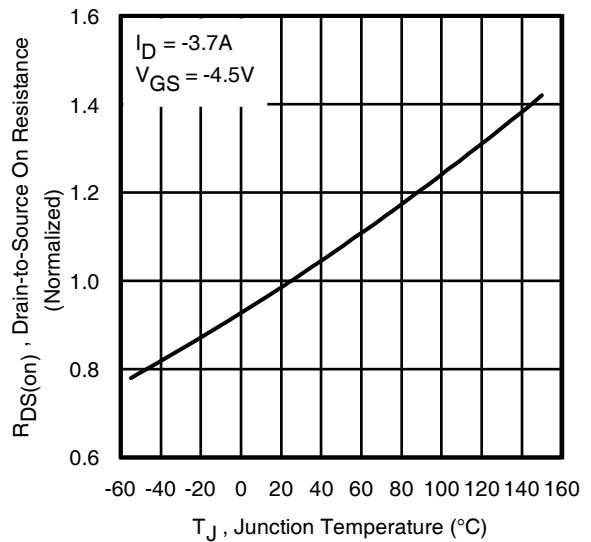

Fig 20. Normalized On-Resistance vs. Temperature

P-Channel

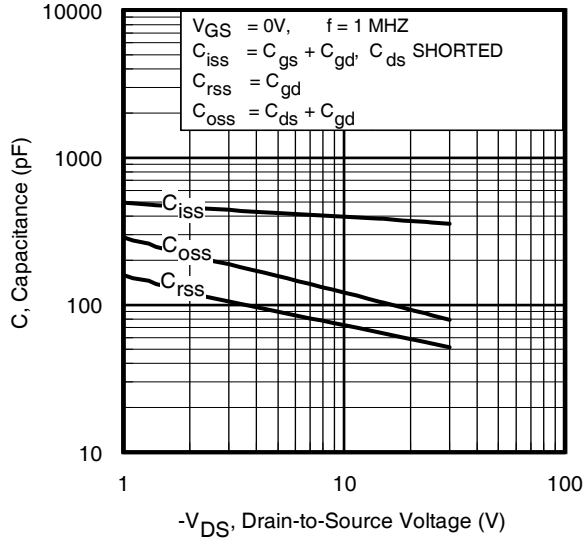

Fig 21. Typical Capacitance vs. Drain-to-Source Voltage

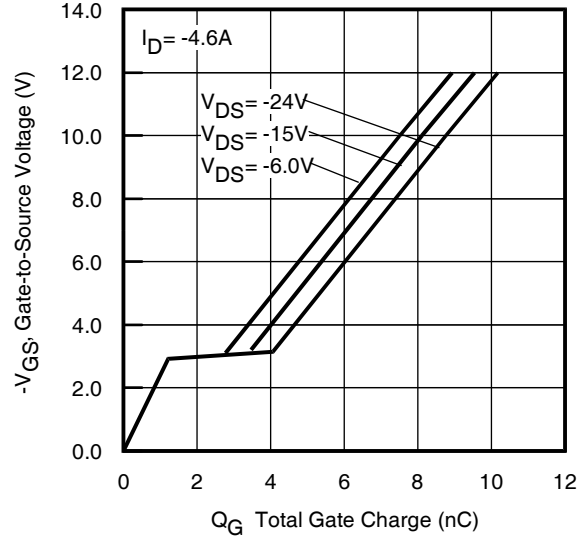

Fig 22. Typical Gate Charge vs. Gate-to-Source Voltage

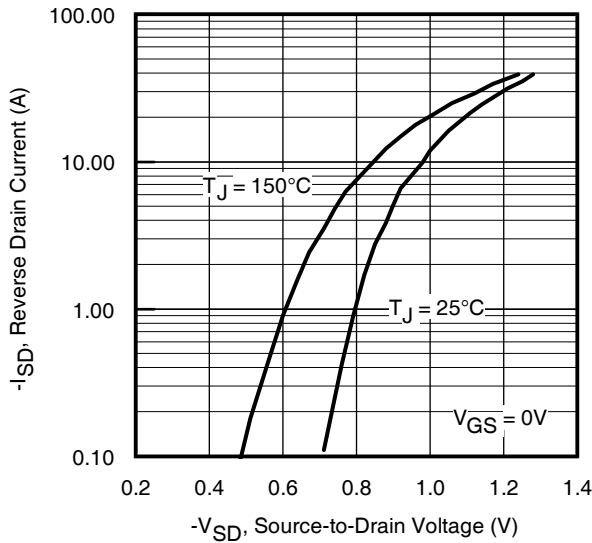

Fig 23. Typical Source-Drain Diode Forward Voltage

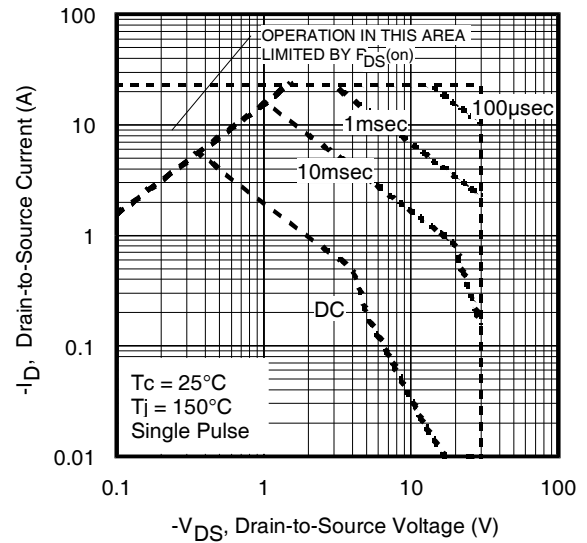
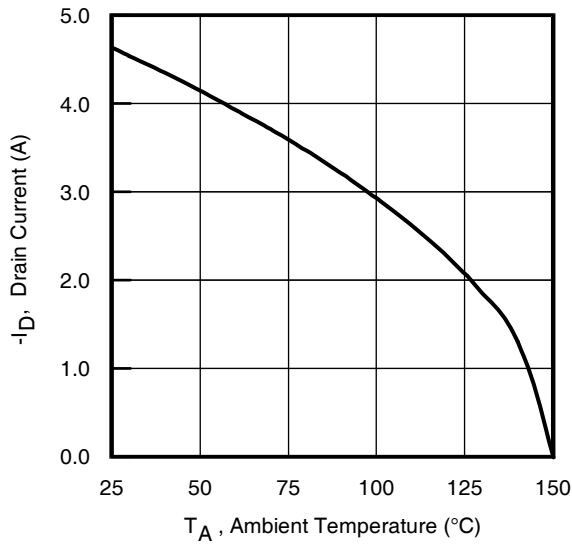
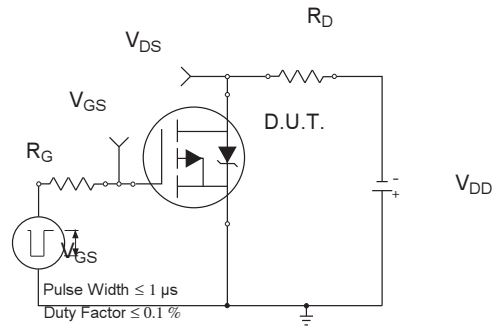
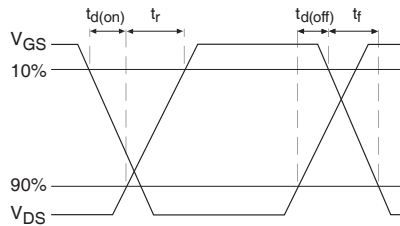
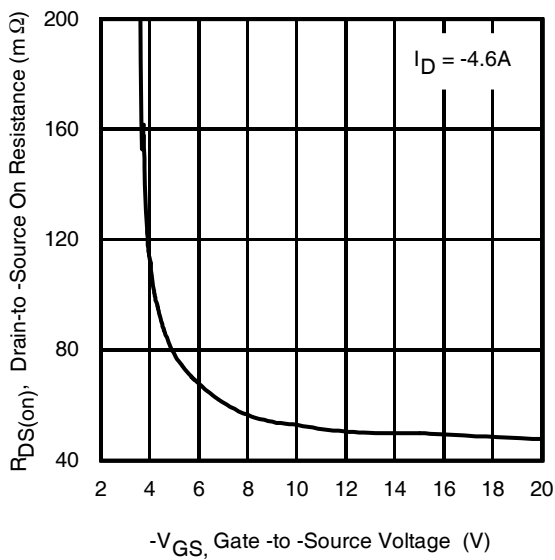
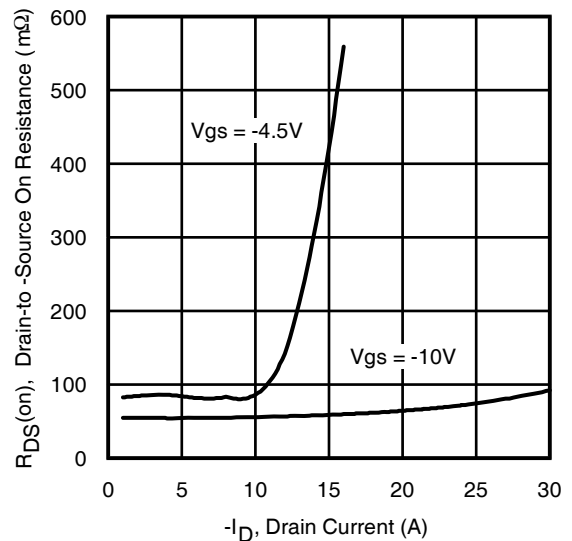

Fig 24. Maximum Safe Operating Area

P-Channel

Fig 25. Maximum Drain Current vs. Ambient Temperature

Fig 26a. Switching Time Test Circuit

Fig 26b. Switching Time Waveforms

Fig 27. Typical On-Resistance vs. Gate Voltage

Fig 28. Typical On-Resistance vs. Drain Current

P-Channel

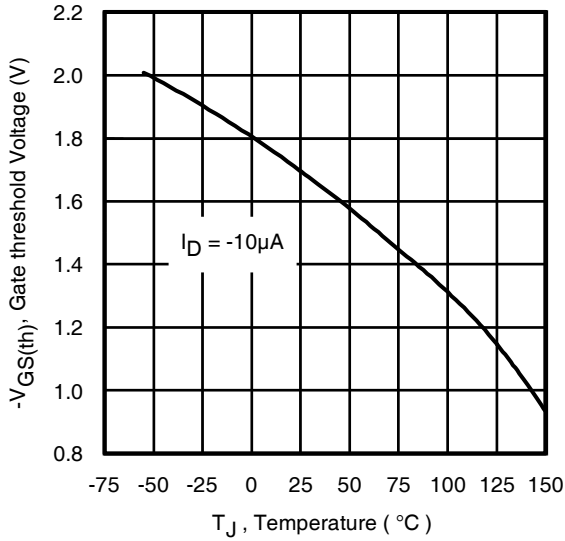

Fig 29. Threshold Voltage vs. Temperature

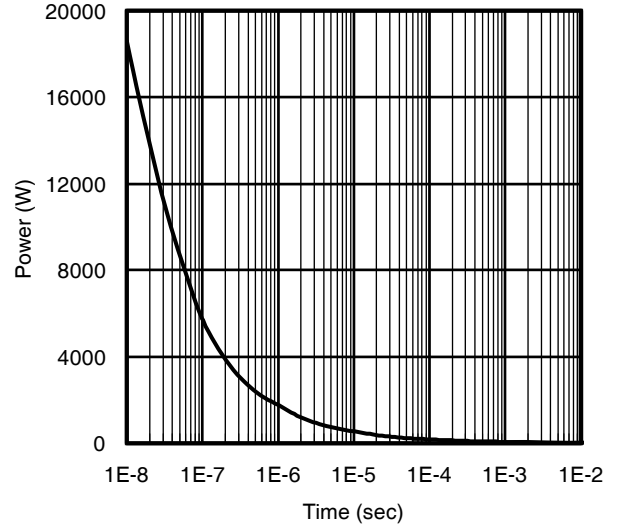

Fig 30. Typical Power vs. Time

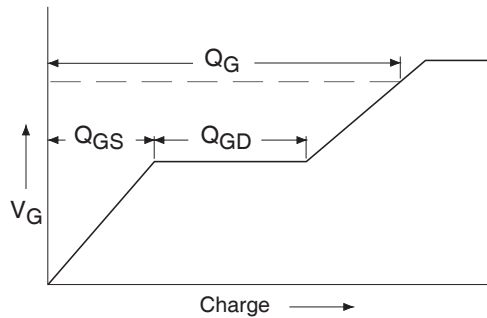

Fig 31a. Basic Gate Charge Waveform

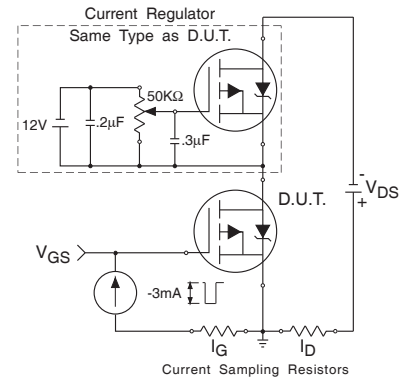
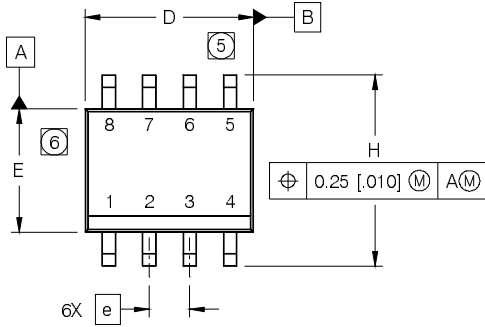
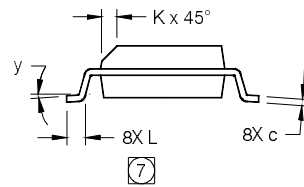
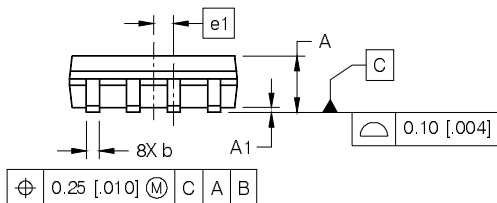

Fig 31b. Gate Charge Test Circuit

SO-8 Package Details



DIM	INCHES		MILLIMETERS	
	MIN	MAX	MIN	MAX
A	.0532	.0688	1.35	1.75
A1	.0040	.0098	0.10	0.25
b	.013	.020	0.33	0.51
c	.0075	.0098	0.19	0.25
D	.189	.1968	4.80	5.00
E	.1497	.1574	3.80	4.00
e	.050 BASIC		1.27 BASIC	
e1	.025 BASIC		0.635 BASIC	
H	.2284	.2440	5.80	6.20
K	.0099	.0196	0.25	0.50
L	.016	.050	0.40	1.27
y	0°	8°	0°	8°



- NOTES:
1. DIMENSIONING & TOLERANCING PER ASME Y14.5M-1994.
 2. CONTROLLING DIMENSION: MILLIMETER
 3. DIMENSIONS ARE SHOWN IN MILLIMETERS [INCHES].
 4. OUTLINE CONFORMS TO JEDEC OUTLINE MS-012AA.
 5. DIMENSION DOES NOT INCLUDE MOLD PROTRUSIONS. MOLD PROTRUSIONS NOT TO EXCEED 0.15 [0.006].
 6. DIMENSION DOES NOT INCLUDE MOLD PROTRUSIONS. MOLD PROTRUSIONS NOT TO EXCEED 0.25 [0.010].
 7. DIMENSION IS THE LENGTH OF LEAD FOR SOLDERING TO A SUBSTRATE.

FOOTPRINT

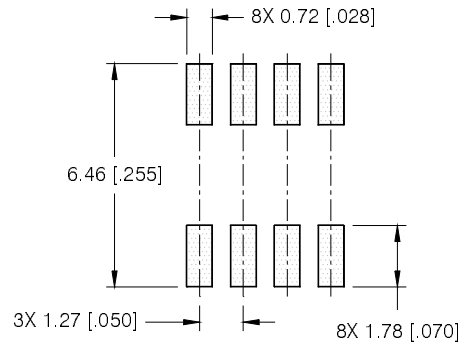

SO-8 Part Marking

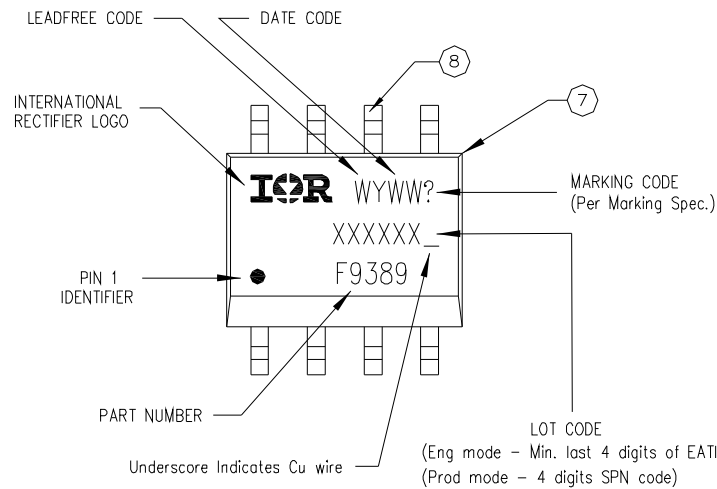

Note: For the most current drawing please refer to IR website at <http://www.irf.com/package/>

Tape and Reel

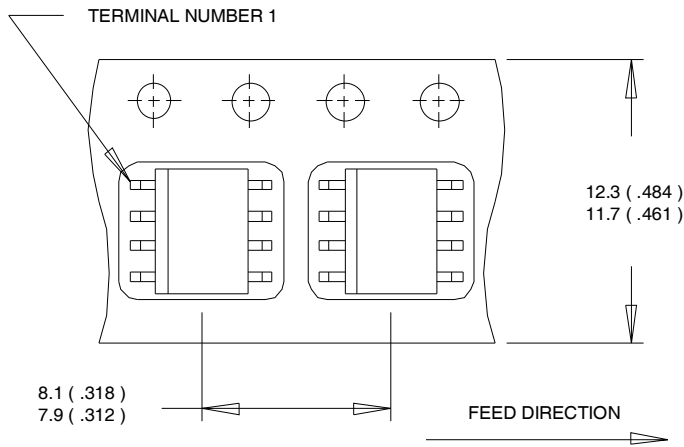

- NOTES:
1. CONTROLLING DIMENSION : MILLIMETER.
 2. ALL DIMENSIONS ARE SHOWN IN MILLIMETERS(INCHES).
 3. OUTLINE CONFORMS TO EIA-481 & EIA-541.

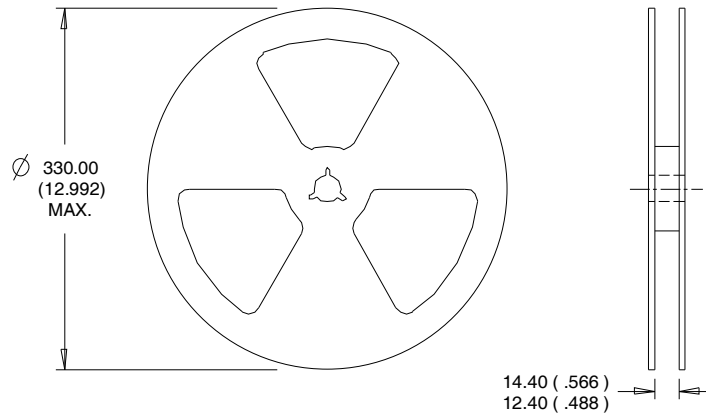

- NOTES :
1. CONTROLLING DIMENSION : MILLIMETER.
 2. OUTLINE CONFORMS TO EIA-481 & EIA-541.

Qualification information[†]

Qualification level	Consumer (per JEDEC JES D47F ^{††} guidelines)	
Moisture Sensitivity Level	SO-8	MSL1 (per JEDEC J-S TD-020D ^{††})
RoHS compliant	Yes	

† Qualification standards can be found at International Rectifier’s web site:

<http://www.irf.com/product-info/reliability/>

†† Applicable version of JEDEC standard at the time of product release.