



Chipsmall Limited consists of a professional team with an average of over 10 year of expertise in the distribution of electronic components. Based in Hongkong, we have already established firm and mutual-benefit business relationships with customers from,Europe,America and south Asia,supplying obsolete and hard-to-find components to meet their specific needs.

With the principle of “Quality Parts,Customers Priority,Honest Operation,and Considerate Service”,our business mainly focus on the distribution of electronic components. Line cards we deal with include Microchip,ALPS,ROHM,Xilinx,Pulse,ON,Everlight and Freescale. Main products comprise IC,Modules,Potentiometer,IC Socket,Relay,Connector.Our parts cover such applications as commercial,industrial, and automotives areas.

We are looking forward to setting up business relationship with you and hope to provide you with the best service and solution. Let us make a better world for our industry!



## Contact us

Tel: +86-755-8981 8866 Fax: +86-755-8427 6832

Email & Skype: info@chipsmall.com Web: www.chipsmall.com

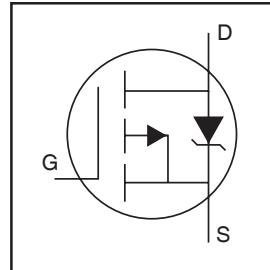
Address: A1208, Overseas Decoration Building, #122 Zhenhua RD., Futian, Shenzhen, China



# IRF9530NPbF

HEXFET® Power MOSFET

- Advanced Process Technology
- Dynamic dv/dt Rating
- 175°C Operating Temperature
- Fast Switching
- P-Channel
- Fully Avalanche Rated
- Lead-Free

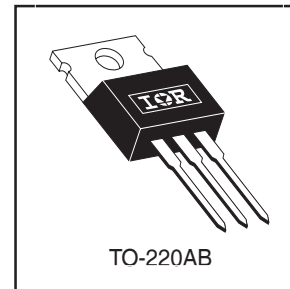


$V_{DSS} = -100V$
$R_{DS(on)} = 0.20\Omega$
$I_D = -14A$

## Description

Fifth Generation HEXFETs from International Rectifier utilize advanced processing techniques to achieve extremely low on-resistance per silicon area. This benefit, combined with the fast switching speed and ruggedized device design that HEXFET Power MOSFETs are well known for, provides the designer with an extremely efficient and reliable device for use in a wide variety of applications.

The TO-220 package is universally preferred for all commercial-industrial applications at power dissipation levels to approximately 50 watts. The low thermal resistance and low package cost of the TO-220 contribute to its wide acceptance throughout the industry.



## Absolute Maximum Ratings

	Parameter	Max.	Units
$I_D @ T_C = 25^\circ C$	Continuous Drain Current, $V_{GS} @ -10V$	-14	A
$I_D @ T_C = 100^\circ C$	Continuous Drain Current, $V_{GS} @ -10V$	-10	
$I_{DM}$	Pulsed Drain Current ①	-56	
$P_D @ T_C = 25^\circ C$	Power Dissipation	79	W
	Linear Derating Factor	0.53	W/°C
$V_{GS}$	Gate-to-Source Voltage	$\pm 20$	V
$E_{AS}$	Single Pulse Avalanche Energy ②	250	mJ
$I_{AR}$	Avalanche Current ①	-8.4	A
$E_{AR}$	Repetitive Avalanche Energy ①	7.9	mJ
dv/dt	Peak Diode Recovery dv/dt ③	-5.0	V/ns
$T_J$	Operating Junction and	-55 to + 175	°C
$T_{STG}$	Storage Temperature Range		
	Soldering Temperature, for 10 seconds		
	Mounting torque, 6-32 or M3 screw	10 lbf•in (1.1N•m)	

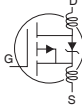
## Thermal Resistance

	Parameter	Typ.	Max.	Units
$R_{\theta JC}$	Junction-to-Case	---	1.9	°C/W
$R_{\theta CS}$	Case-to-Sink, Flat, Greased Surface	0.50	---	
$R_{\theta JA}$	Junction-to-Ambient	---	62	

# IRF9530NPbF

International  
**IR** Rectifier

## Electrical Characteristics @ $T_J = 25^\circ\text{C}$ (unless otherwise specified)

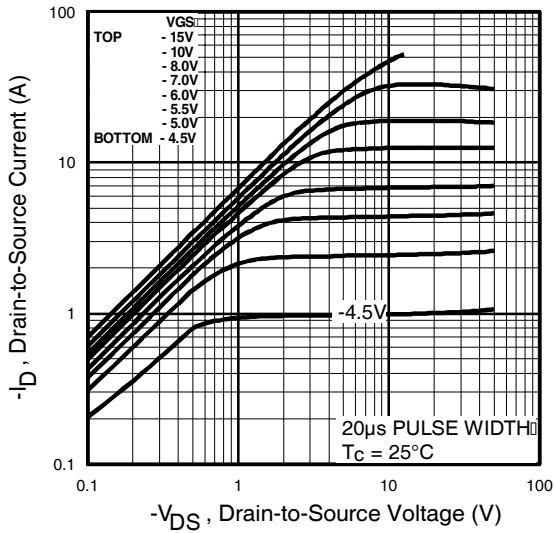
	Parameter	Min.	Typ.	Max.	Units	Conditions
$V_{(BR)DSS}$	Drain-to-Source Breakdown Voltage	-100	—	—	V	$V_{GS} = 0V, I_D = -250\mu A$
$\Delta V_{(BR)DSS}/\Delta T_J$	Breakdown Voltage Temp. Coefficient	—	-0.11	—	V/ $^\circ\text{C}$	Reference to $25^\circ\text{C}, I_D = -1\text{mA}$
$R_{DS(on)}$	Static Drain-to-Source On-Resistance	—	—	0.20	$\Omega$	$V_{GS} = -10V, I_D = -8.4A$ ④
$V_{GS(th)}$	Gate Threshold Voltage	-2.0	—	-4.0	V	$V_{DS} = V_{GS}, I_D = -250\mu A$
$g_{fs}$	Forward Transconductance	3.2	—	—	S	$V_{DS} = -50V, I_D = -8.4A$
$I_{DSS}$	Drain-to-Source Leakage Current	—	—	-25	$\mu A$	$V_{DS} = -100V, V_{GS} = 0V$
		—	—	-250		$V_{DS} = -80V, V_{GS} = 0V, T_J = 150^\circ\text{C}$
$I_{GSS}$	Gate-to-Source Forward Leakage	—	—	100	nA	$V_{GS} = 20V$
	Gate-to-Source Reverse Leakage	—	—	-100		$V_{GS} = -20V$
$Q_g$	Total Gate Charge	—	—	58	nC	$I_D = -8.4A$
$Q_{gs}$	Gate-to-Source Charge	—	—	8.3		$V_{DS} = -80V$
$Q_{gd}$	Gate-to-Drain ("Miller") Charge	—	—	32		$V_{GS} = -10V$ , See Fig. 6 and 13 ④
$t_{d(on)}$	Turn-On Delay Time	—	15	—	ns	$V_{DD} = -50V$
$t_r$	Rise Time	—	58	—		$I_D = -8.4A$
$t_{d(off)}$	Turn-Off Delay Time	—	45	—		$R_G = 9.1\Omega$
$t_f$	Fall Time	—	46	—		$R_D = 6.2\Omega$ , See Fig. 10 ④
$L_D$	Internal Drain Inductance	—	4.5	—	nH	Between lead, 6mm (0.25in.) from package and center of die contact
$L_S$	Internal Source Inductance	—	7.5	—		
$C_{iss}$	Input Capacitance	—	760	—	pF	$V_{GS} = 0V$
$C_{oss}$	Output Capacitance	—	260	—		$V_{DS} = -25V$
$C_{rss}$	Reverse Transfer Capacitance	—	170	—		$f = 1.0\text{MHz}$ , See Fig. 5

## Source-Drain Ratings and Characteristics

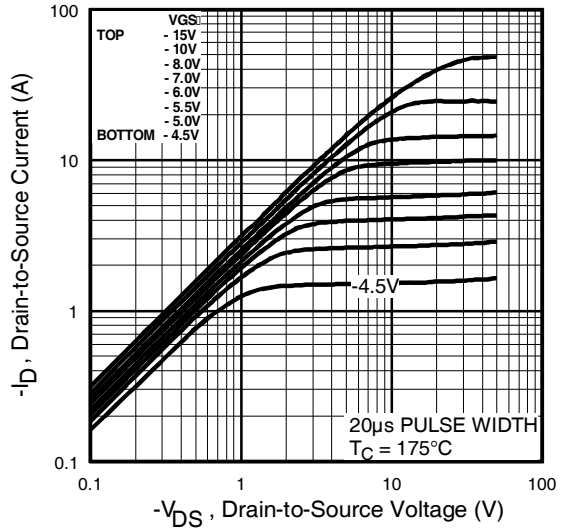
	Parameter	Min.	Typ.	Max.	Units	Conditions
$I_S$	Continuous Source Current (Body Diode)	—	—	-14	A	MOSFET symbol showing the integral reverse p-n junction diode.
$I_{SM}$	Pulsed Source Current (Body Diode) ①	—	—	-56		
$V_{SD}$	Diode Forward Voltage	—	—	-1.6	V	$T_J = 25^\circ\text{C}, I_S = -8.4A, V_{GS} = 0V$ ④
$t_{rr}$	Reverse Recovery Time	—	130	190	ns	$T_J = 25^\circ\text{C}, I_F = -8.4A$
$Q_{rr}$	Reverse Recovery Charge	—	650	970	nC	$di/dt = -100A/\mu s$ ④
$t_{on}$	Forward Turn-On Time	Intrinsic turn-on time is negligible (turn-on is dominated by $L_S + L_D$ )				

### Notes:

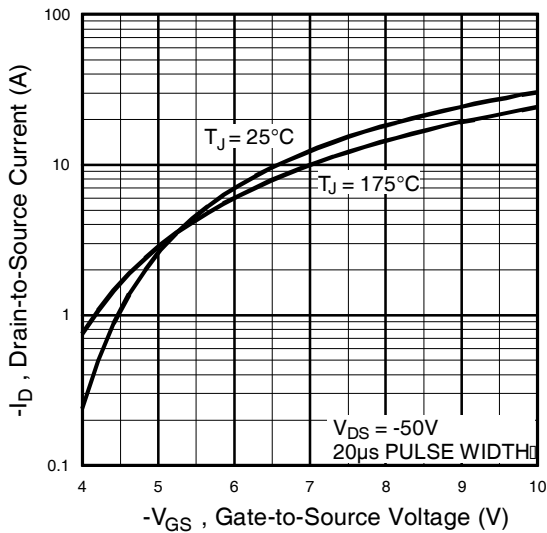
- ① Repetitive rating; pulse width limited by max. junction temperature. ( See fig. 11 )
- ② Starting  $T_J = 25^\circ\text{C}$ ,  $L = 7.0\text{mH}$   
 $R_G = 25\Omega, I_{AS} = -8.4A$ . (See Figure 12)
- ③  $I_{SD} \leq -8.4A, di/dt \leq -490A/\mu s, V_{DD} \leq V_{(BR)DSS}, T_J \leq 175^\circ\text{C}$
- ④ Pulse width  $\leq 300\mu s$ ; duty cycle  $\leq 2\%$ .



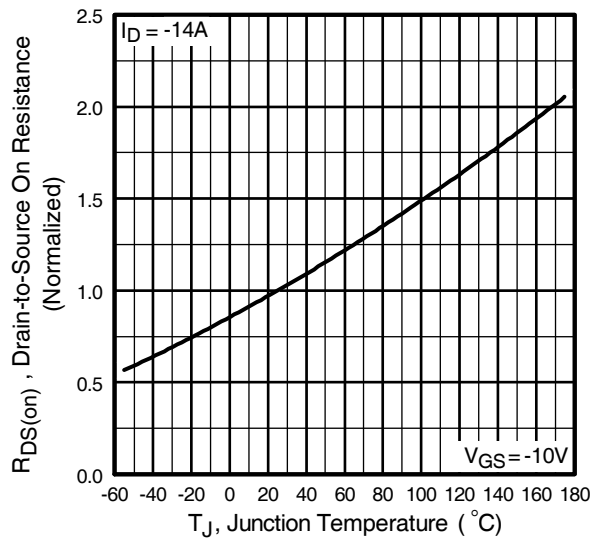
**Fig 1.** Typical Output Characteristics



**Fig 2.** Typical Output Characteristics



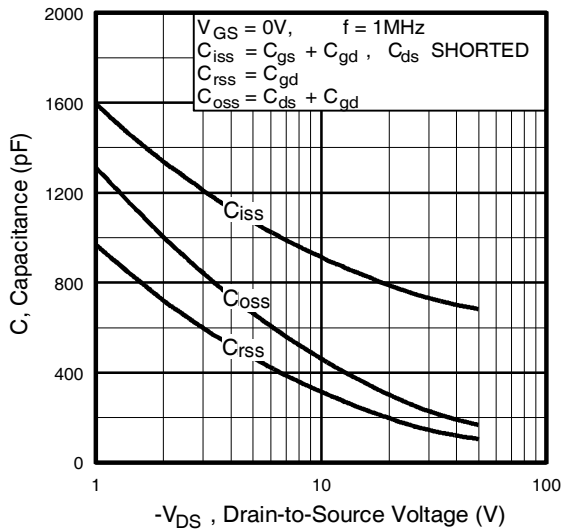
**Fig 3.** Typical Transfer Characteristics



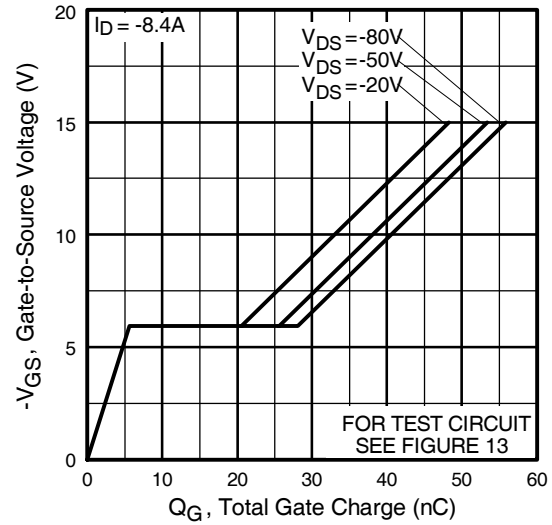
**Fig 4.** Normalized On-Resistance Vs. Temperature

# IRF9530NPbF

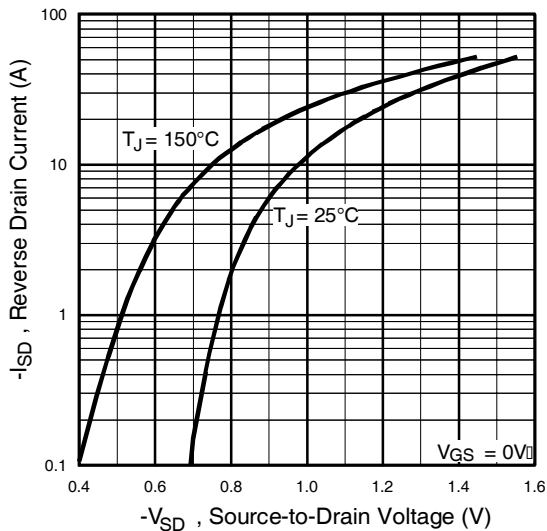
International  
**IR** Rectifier



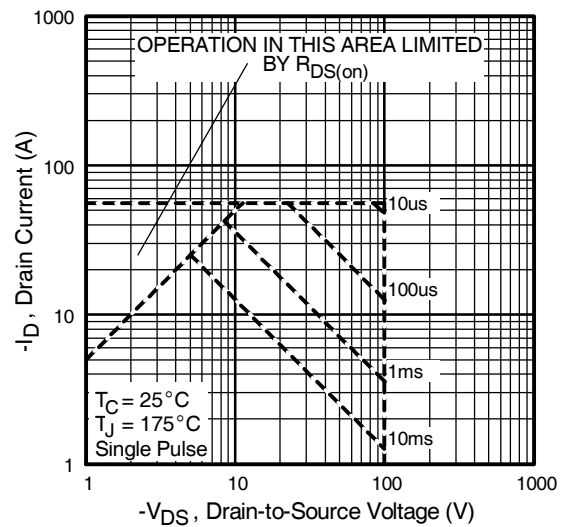
**Fig 5.** Typical Capacitance Vs. Drain-to-Source Voltage



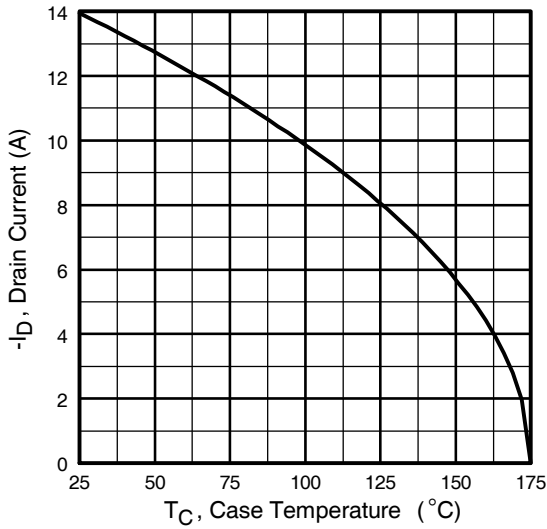
**Fig 6.** Typical Gate Charge Vs. Gate-to-Source Voltage



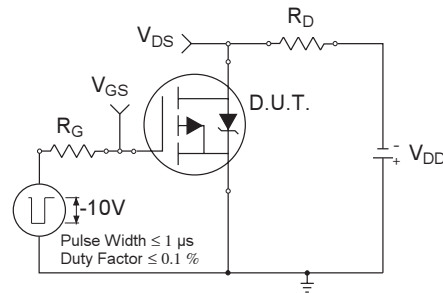
**Fig 7.** Typical Source-Drain Diode Forward Voltage



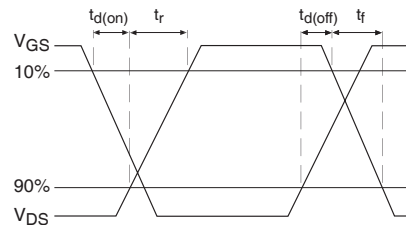
**Fig 8.** Maximum Safe Operating Area



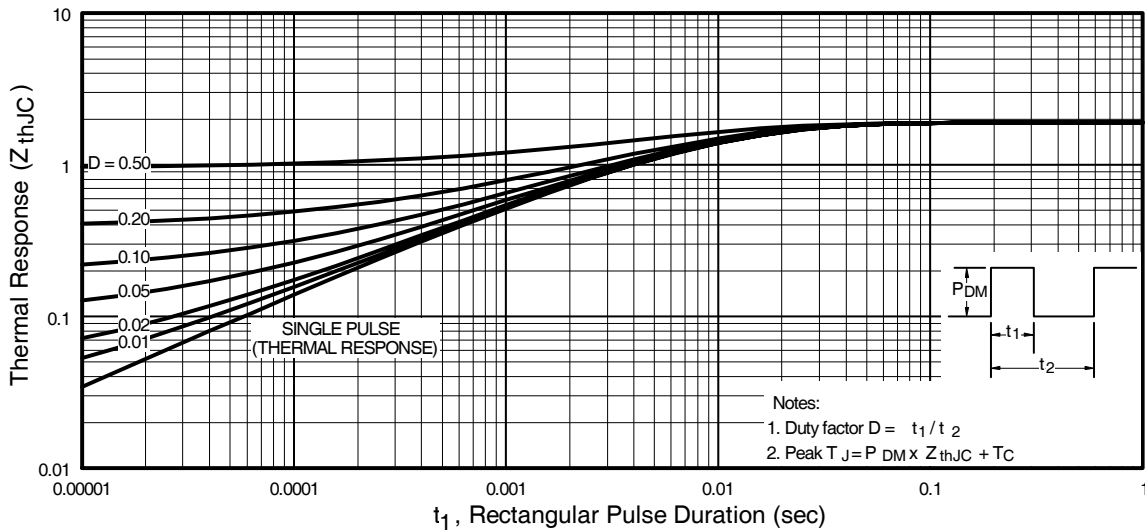
**Fig 9.** Maximum Drain Current Vs. Case Temperature



**Fig 10a.** Switching Time Test Circuit



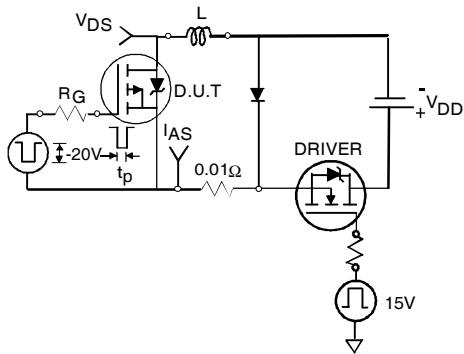
**Fig 10b.** Switching Time Waveforms



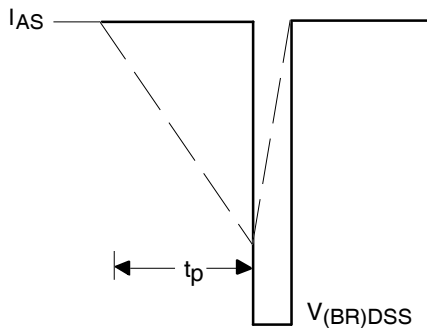
**Fig 11.** Maximum Effective Transient Thermal Impedance, Junction-to-Case

# IRF9530NPbF

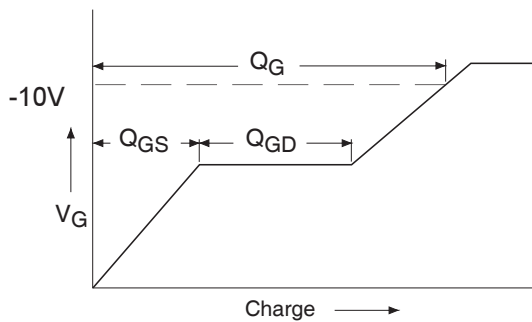
International  
**IGR** Rectifier



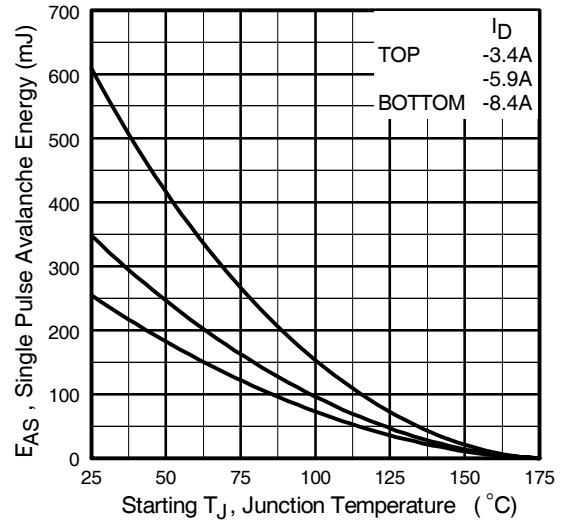
**Fig 12a.** Unclamped Inductive Test Circuit



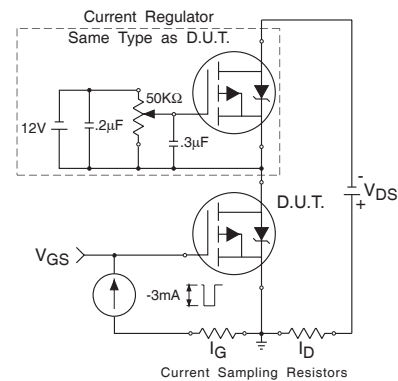
**Fig 12b.** Unclamped Inductive Waveforms



**Fig 13a.** Basic Gate Charge Waveform

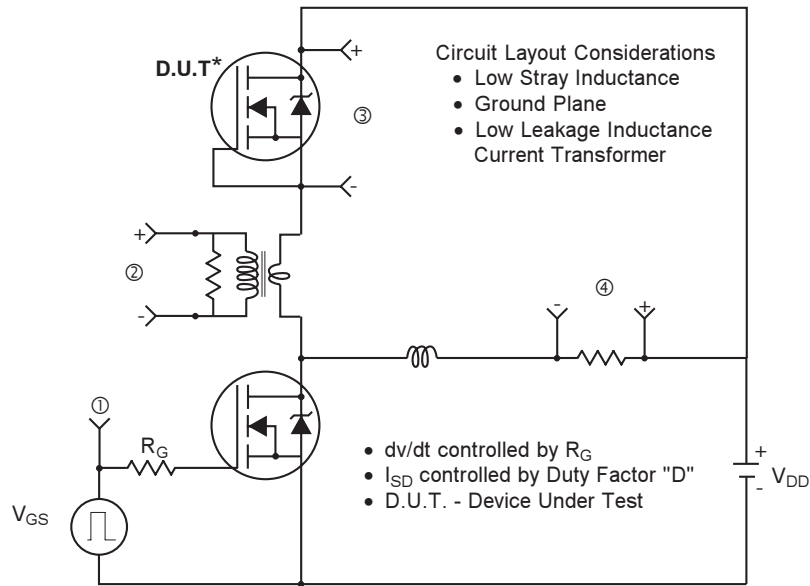


**Fig 12c.** Maximum Avalanche Energy Vs. Drain Current

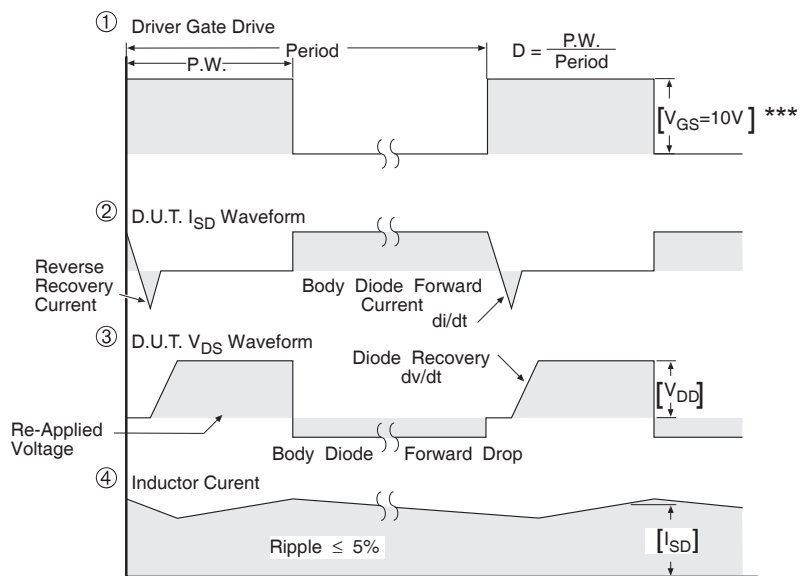


**Fig 13b.** Gate Charge Test Circuit

## Peak Diode Recovery dv/dt Test Circuit



\* Reverse Polarity of D.U.T for P-Channel



\*\*\*  $V_{GS} = 5.0V$  for Logic Level and 3V Drive Devices

**Fig 14. For P-Channel HEXFETS**

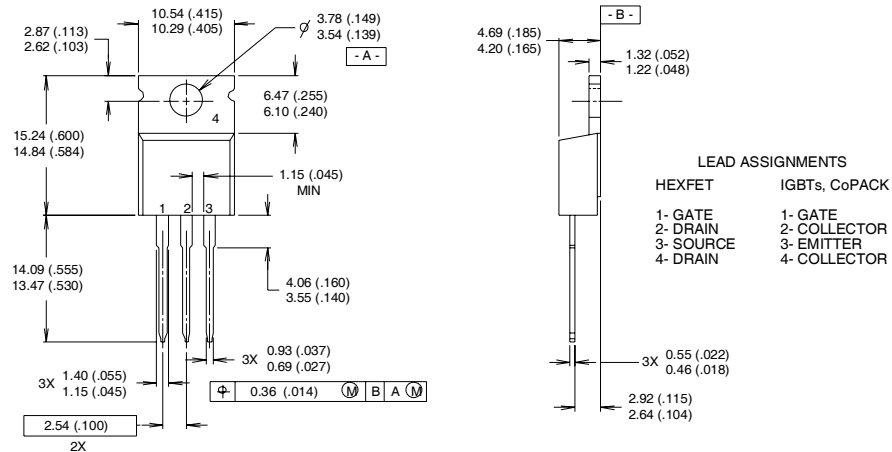


# IRF9530NPbF

International  
**IR** Rectifier

## TO-220AB Package Outline

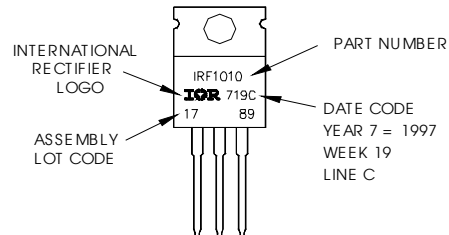
Dimensions are shown in millimeters (inches)



- NOTES:
- 1 DIMENSIONING & TOLERANCING PER ANSI Y14.5M, 1982.
  - 2 CONTROLLING DIMENSION : INCH
  - 3 OUTLINE CONFORMS TO JEDEC OUTLINE TO-220AB.
  - 4 HEATSINK & LEAD MEASUREMENTS DO NOT INCLUDE BURRS.

## TO-220AB Part Marking Information

EXAMPLE: THIS IS AN IRF1010  
LOT CODE 1789  
ASSEMBLED ON WW 19, 1997  
IN THE ASSEMBLY LINE "C"  
**Note:** "P" in assembly line  
position indicates "Lead-Free"



Data and specifications subject to change without notice.

International  
**IR** Rectifier

IR WORLD HEADQUARTERS: 233 Kansas St., El Segundo, California 90245, USA Tel: (310) 252-7105  
TAC Fax: (310) 252-7903

Visit us at [www.irf.com](http://www.irf.com) for sales contact information.02/04

Note: For the most current drawings please refer to the IR website at:  
<http://www.irf.com/package/>