



Chipsmall Limited consists of a professional team with an average of over 10 year of expertise in the distribution of electronic components. Based in Hongkong, we have already established firm and mutual-benefit business relationships with customers from,Europe,America and south Asia,supplying obsolete and hard-to-find components to meet their specific needs.

With the principle of “Quality Parts,Customers Priority,Honest Operation,and Considerate Service”,our business mainly focus on the distribution of electronic components. Line cards we deal with include Microchip,ALPS,ROHM,Xilinx,Pulse,ON,Everlight and Freescale. Main products comprise IC,Modules,Potentiometer,IC Socket,Relay,Connector.Our parts cover such applications as commercial,industrial, and automotives areas.

We are looking forward to setting up business relationship with you and hope to provide you with the best service and solution. Let us make a better world for our industry!



Contact us

Tel: +86-755-8981 8866 Fax: +86-755-8427 6832

Email & Skype: info@chipsmall.com Web: www.chipsmall.com

Address: A1208, Overseas Decoration Building, #122 Zhenhua RD., Futian, Shenzhen, China



HEXFET® Power MOSFET

	Q1	Q2	
V_{DSS}	25	25	V
R_{DS(on)} max (@V _{GS} = 4.5V)	4.60	2.10	mΩ
Qg (typical)	10	23	nC
I_D (@T _C = 25°C)	30 Ⓣ	30 Ⓣ	A

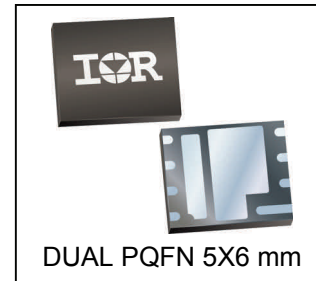
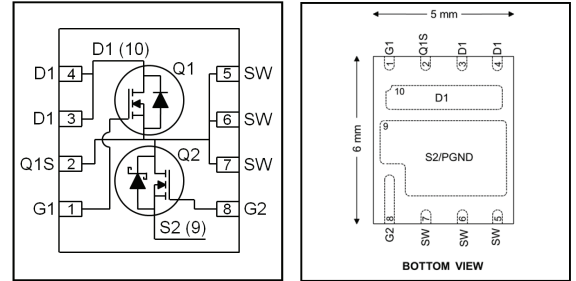

Applications

- Control and Synchronous MOSFETs for synchronous buck converters

Features

Control and synchronous MOSFETs in one package
Low charge control MOSFET (10nC typical)
Low R _{DS(on)} synchronous MOSFET (<2.10mΩ)
Intrinsic Schottky Diode with Low Forward Voltage on Q2
RoHS Compliant, Halogen-Free
MSL1, Industrial Qualification

results in
⇒

Benefits

Increased power density
Lower switching losses
Lower conduction losses
Lower Switching Losses
Environmentally friendlier
Increased reliability

Base part number	Package Type	Standard Pack		Orderable Part Number
		Form	Quantity	
IRFH4255DPbF	Dual PQFN 5mm x 6mm	Tape and Reel	4000	IRFH4255DTRPbF

Absolute Maximum Ratings

	Parameter	Q1 Max.	Q2 Max.	Units
V _{GS}	Gate-to-Source Voltage	± 20		V
I _D @ T _C = 25°C	Continuous Drain Current, V _{GS} @ 4.5V	64ⓉⓈ	105ⓉⓈ	A
I _D @ T _C = 70°C	Continuous Drain Current, V _{GS} @ 4.5V	51ⓉⓈ	84ⓉⓈ	
I _D @ T _C = 25°C	Continuous Drain Current, V _{GS} @ 4.5V (Source Bonding Technology Limited)	30Ⓣ	30Ⓣ	
I _{DM}	Pulsed Drain Current	120	420Ⓢ	W
P _D @ T _C = 25°C	Power Dissipation	31	38	
P _D @ T _C = 70°C	Power Dissipation	20	24	W/°C
	Linear Derating Factor	0.25	0.30	
T _J T _{STG}	Operating Junction and Storage Temperature Range	-55 to + 150		°C

Thermal Resistance

	Parameter	Q1 Max.	Q2 Max.	Units
R _{θJC} (Bottom)	Junction-to-Case ④	4.0	3.3	°C/W
R _{θJC} (Top)	Junction-to-Case ④	20	12	
R _{θJA}	Junction-to-Ambient ⑤	34	31	
R _{θJA} (<10s)	Junction-to-Ambient ⑤	24	19	

Notes ① through ⑧ are on page 12

Static @ T_J = 25°C (unless otherwise specified)

	Parameter		Min.	Typ.	Max.	Units	Conditions
BV _{DSS}	Drain-to-Source Breakdown Voltage	Q1	25	—	—	V	V _{GS} = 0V, I _D = 250μA
		Q2	25	—	—		V _{GS} = 0V, I _D = 1.0mA
ΔBV _{DSS} /ΔT _J	Breakdown Voltage Temp. Coefficient	Q1	—	22	—	mV/°C	Reference to 25°C, I _D = 1.0mA
		Q2	—	23	—		Reference to 25°C, I _D = 10mA
R _{DS(on)}	Static Drain-to-Source On-Resistance	Q1	—	2.50	3.20	mΩ	V _{GS} = 10V, I _D = 30A ③
		Q2	—	1.20	1.50		V _{GS} = 10V, I _D = 30A ③
		Q1	—	3.70	4.60		V _{GS} = 4.5V, I _D = 30A ③
		Q2	—	1.65	2.10		V _{GS} = 4.5V, I _D = 30A ③
V _{GS(th)}	Gate Threshold Voltage	Q1	1.1	1.6	2.1	V	Q1: V _{DS} = V _{GS} , I _D = 35μA
		Q2	1.1	1.6	2.1		Q2: V _{DS} = V _{GS} , I _D = 100μA
ΔV _{GS(th)} /ΔT _J	Gate Threshold Voltage Coefficient	Q1	—	-5.7	—	mV/°C	Q1: V _{DS} = V _{GS} , I _D = 35μA
		Q2	—	-5.3	—		Q2: V _{DS} = V _{GS} , I _D = 1mA
I _{DSS}	Drain-to-Source Leakage Current	Q1	—	—	1.0	μA	V _{DS} = 20V, V _{GS} = 0V
		Q2	—	—	250		V _{DS} = 20V, V _{GS} = 0V
I _{GSS}	Gate-to-Source Forward Leakage	Q1	—	—	100	nA	V _{GS} = 20V
		Q2	—	—	100		V _{GS} = 20V
	Gate-to-Source Reverse Leakage	Q1	—	—	-100		V _{GS} = -20V
		Q2	—	—	-100		V _{GS} = -20V
g _{fs}	Forward Transconductance	Q1	131	—	—	S	V _{DS} = 10V, I _D = 30A
		Q2	182	—	—		V _{DS} = 10V, I _D = 30A
Q _g	Total Gate Charge	Q1	—	10	15	nC	Q1 V _{DS} = 13V V _{GS} = 4.5V, I _D = 30A Q2 V _{DS} = 13V V _{GS} = 4.5V, I _D = 30A
Q _{gs1}	Pre-V _{th} Gate-to-Source Charge	Q1	—	2.5	—		
		Q2	—	4.5	—		
Q _{gs2}	Post-V _{th} Gate-to-Source Charge	Q1	—	1.6	—		
		Q2	—	2.3	—		
Q _{gd}	Gate-to-Drain Charge	Q1	—	3.8	—		
		Q2	—	8.4	—		
Q _{godr}	Gate Charge Overdrive	Q1	—	2.1	—		
		Q2	—	7.8	—		
Q _{sw}	Switch Charge (Q _{gs2} + Q _{gd})	Q1	—	5.4	—		
		Q2	—	10.7	—		
Q _{oss}	Output Charge	Q1	—	10	—	nC	V _{DS} = 16V, V _{GS} = 0V
		Q2	—	23	—		
R _G	Gate Resistance	Q1	—	2.4	—	Ω	
		Q2	—	1.5	—		
t _{d(on)}	Turn-On Delay Time	Q1	—	10	—	ns	Q1 V _{DS} = 13V V _{GS} = 4.5V I _D = 30A, R _g = 1.8Ω
		Q2	—	10	—		
t _r	Rise Time	Q1	—	61	—	ns	Q2 V _{DS} = 13V V _{GS} = 4.5V I _D = 30A, R _g = 1.8Ω
		Q2	—	43	—		
t _{d(off)}	Turn-Off Delay Time	Q1	—	13	—	ns	Q2 V _{DS} = 13V V _{GS} = 4.5V I _D = 30A, R _g = 1.8Ω
		Q2	—	27	—		
t _f	Fall Time	Q1	—	15	—	ns	Q2 V _{DS} = 13V V _{GS} = 4.5V I _D = 30A, R _g = 1.8Ω
		Q2	—	26	—		
C _{iss}	Input Capacitance	Q1	—	1314	—	pF	V _{GS} = 0V V _{DS} = 13V f = 1.0MHz
		Q2	—	2877	—		
C _{oss}	Output Capacitance	Q1	—	365	—	pF	V _{GS} = 0V V _{DS} = 13V f = 1.0MHz
		Q2	—	907	—		
C _{rss}	Reverse Transfer Capacitance	Q1	—	92	—	pF	V _{GS} = 0V V _{DS} = 13V f = 1.0MHz
		Q2	—	234	—		

Avalanche Characteristics

	Parameter	Typ.	Q1 Max.	Q2 Max.	Units
E _{AS}	Single Pulse Avalanche Energy ②	—	61	364	mJ

Diode Characteristics

	Parameter		Min.	Typ.	Max.	Units	Conditions
I _S	Continuous Source Current (Body Diode)	Q1	—	—	30⑦	A	MOSFET symbol showing the integral reverse p-n junction diode.
		Q2	—	—	30⑦		
I _{SM}	Pulsed Source Current (Body Diode)	Q1	—	—	120	A	
		Q2	—	—	420⑧		
V _{SD}	Diode Forward Voltage	Q1	—	—	1.0	V	T _J = 25°C, I _S = 30A, V _{GS} = 0V③
		Q2	—	—	0.75		T _J = 25°C, I _S = 30A, V _{GS} = 0V③
t _{rr}	Reverse Recovery Time	Q1	—	16	—	ns	Q1 T _J = 25°C, I _F = 30A V _{DD} = 13V, di/dt = 235A/μs ③
		Q2	—	26	—		
Q _{rr}	Reverse Recovery Charge	Q1	—	13	—	nC	Q2 T _J = 25°C, I _F = 30A V _{DD} = 13V, di/dt = 270A/μs ③
		Q2	—	34	—		

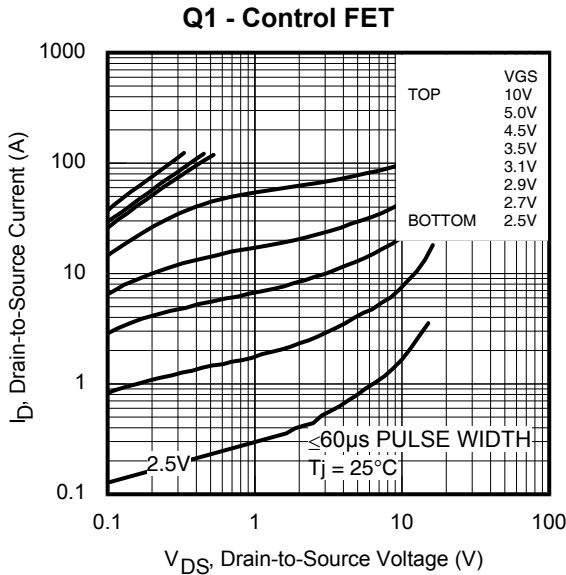
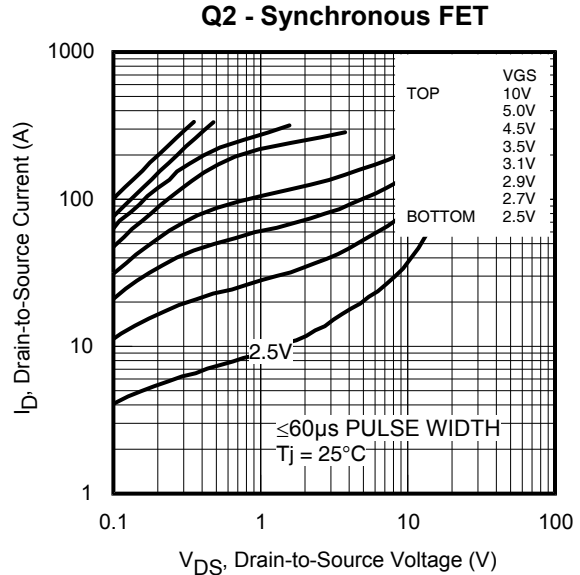
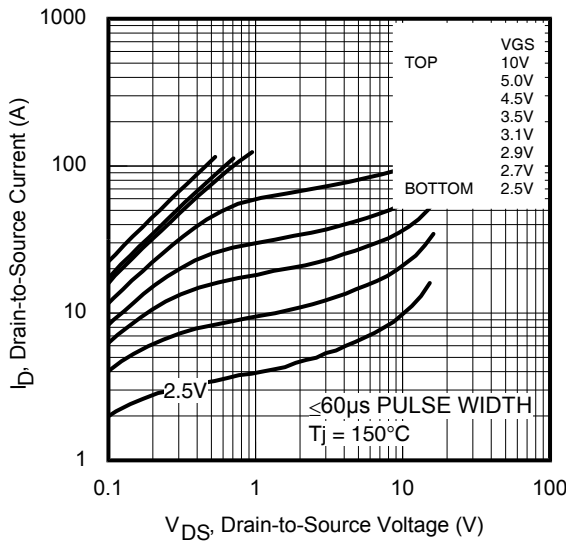
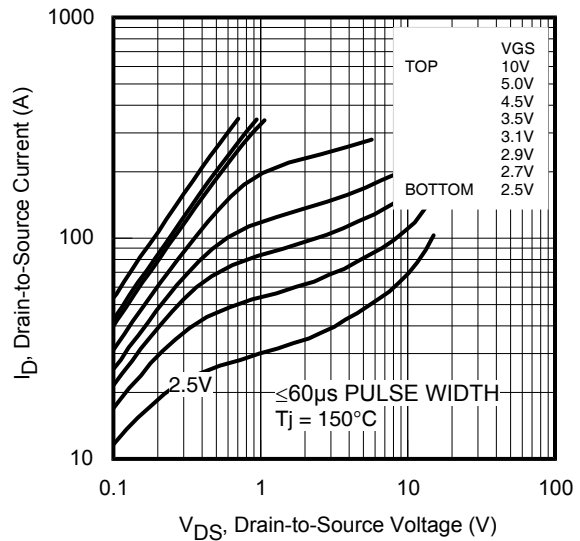
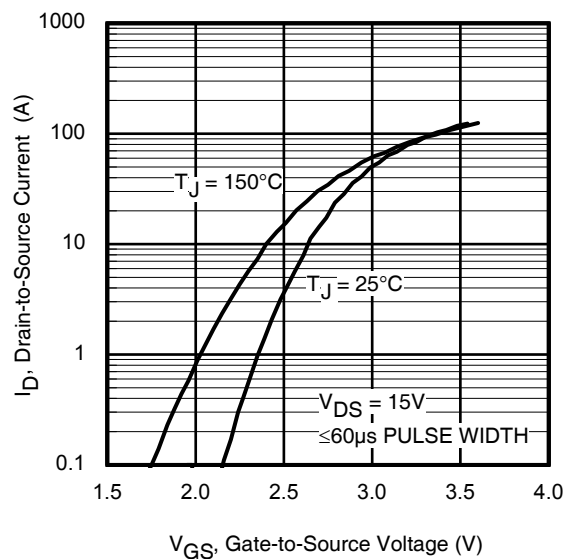
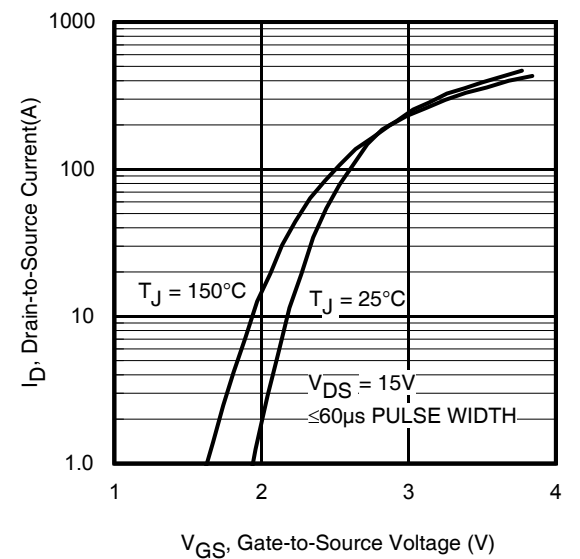
Fig 1. Typical Output Characteristics

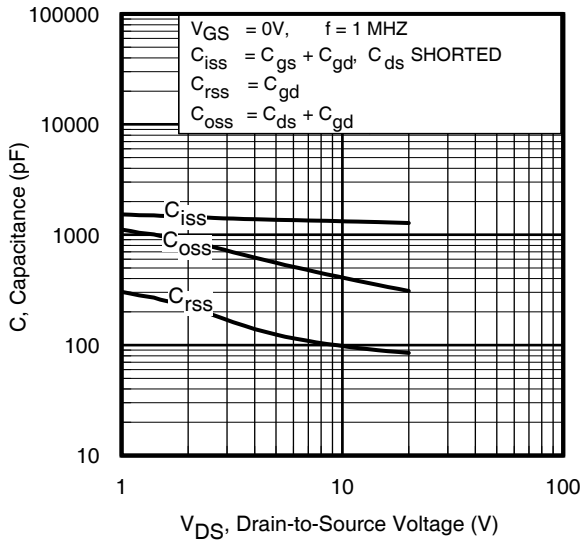
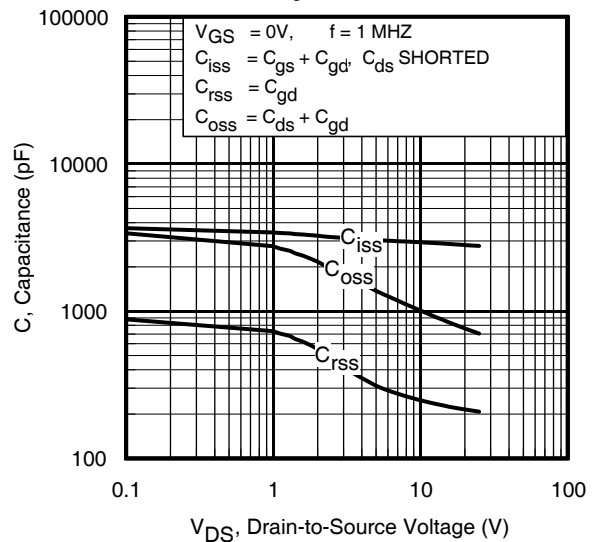
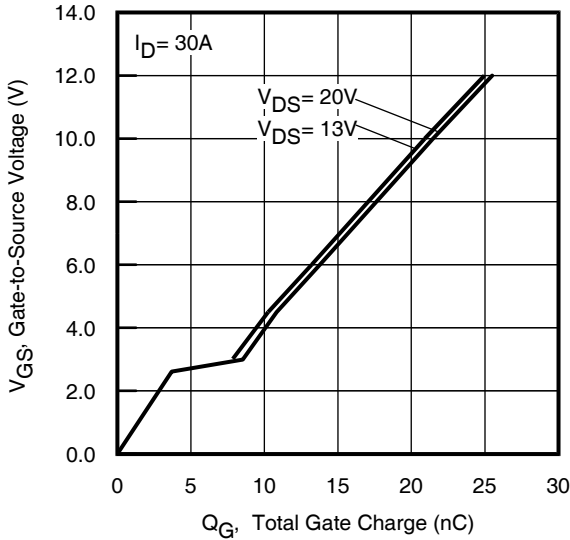
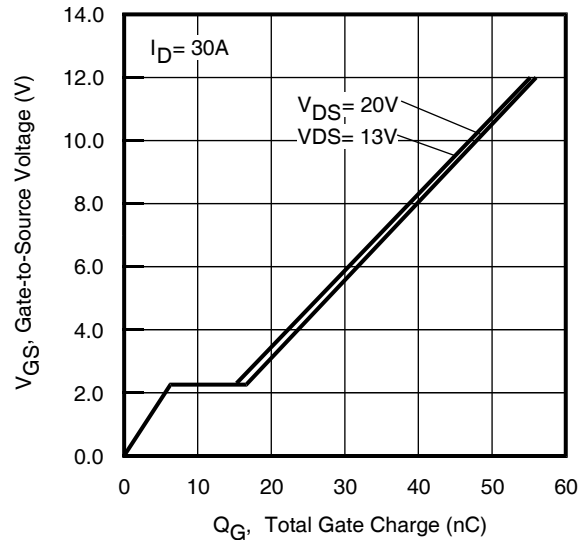
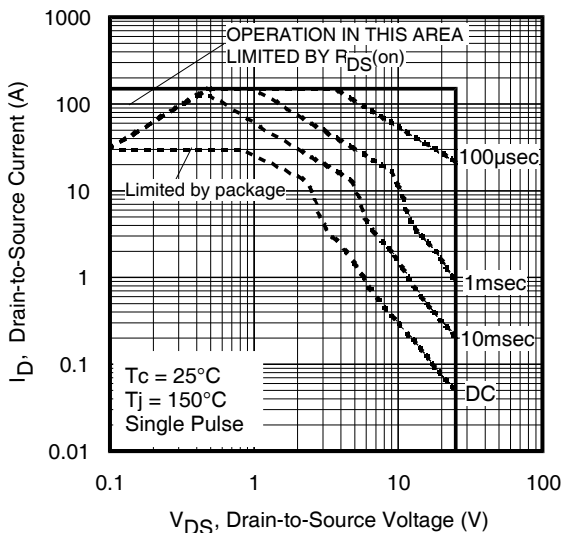
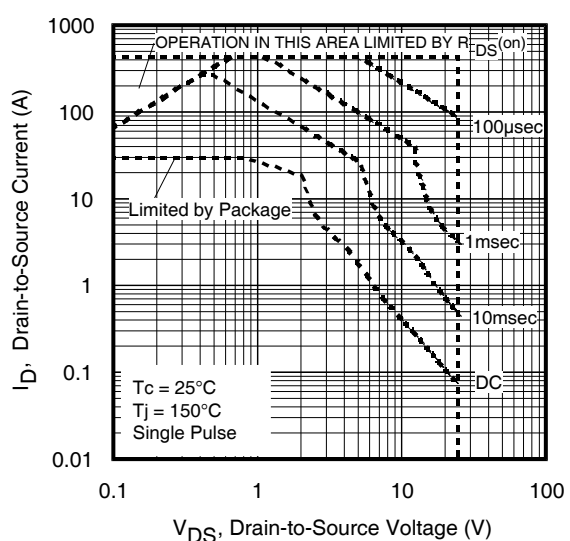
Fig 2. Typical Output Characteristics

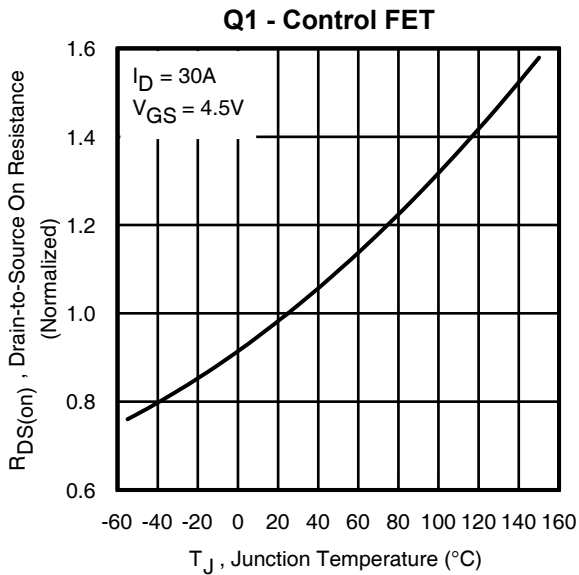
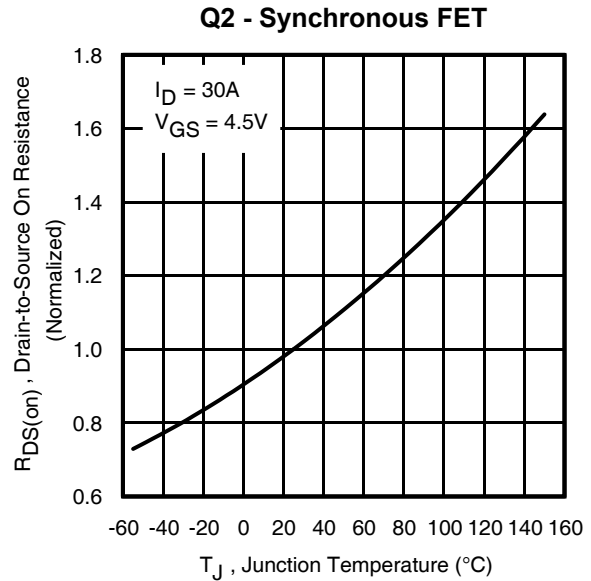
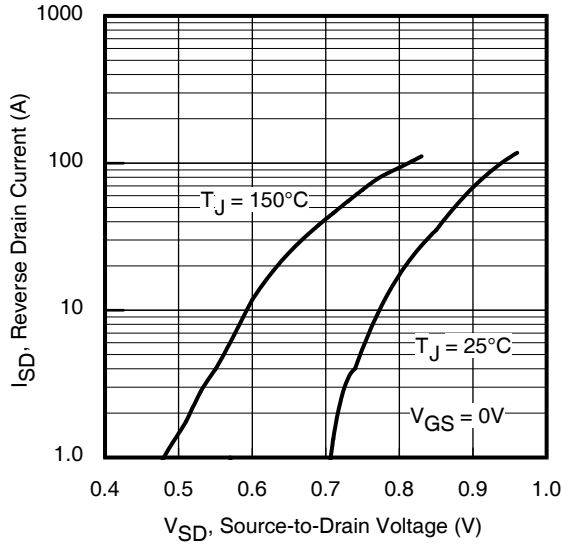
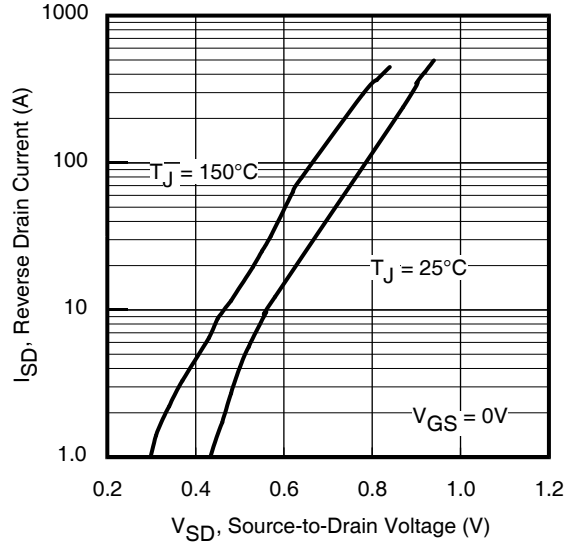
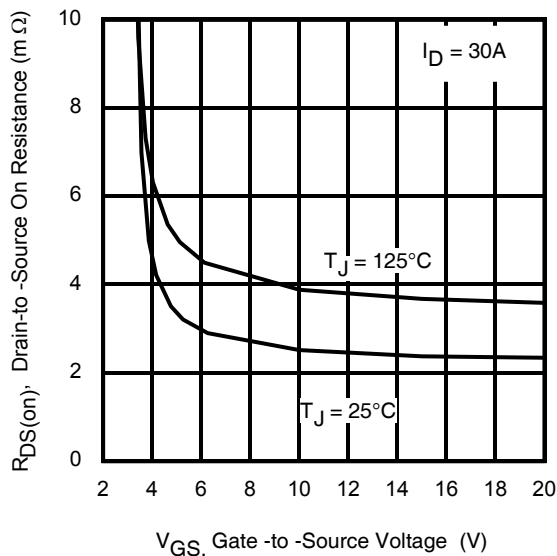
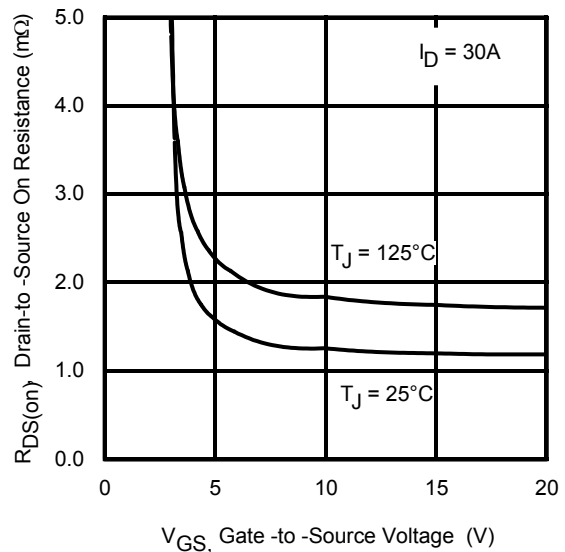
Fig 3. Typical Output Characteristics

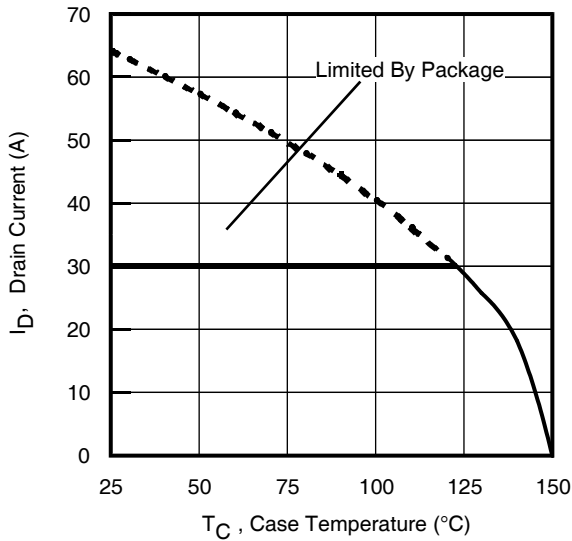
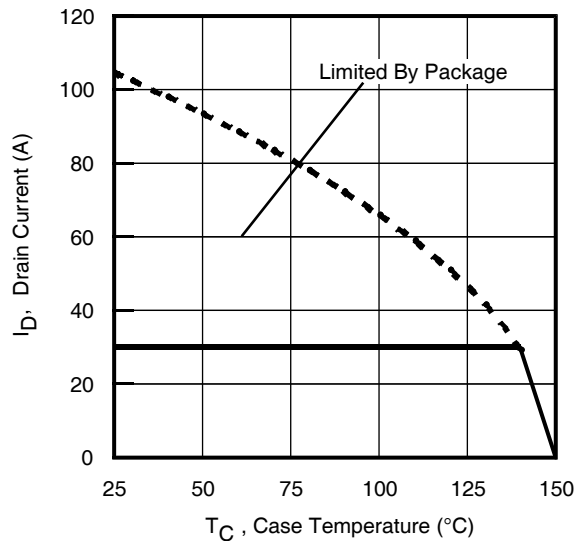
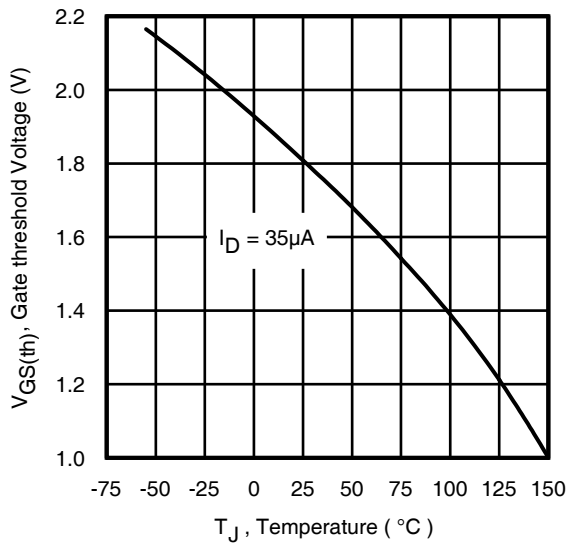
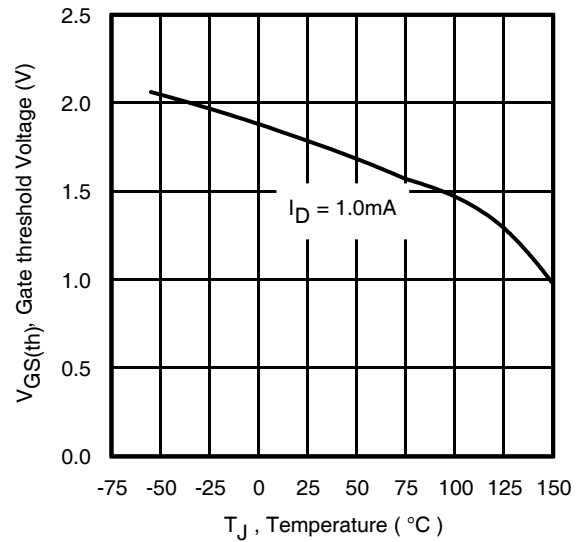
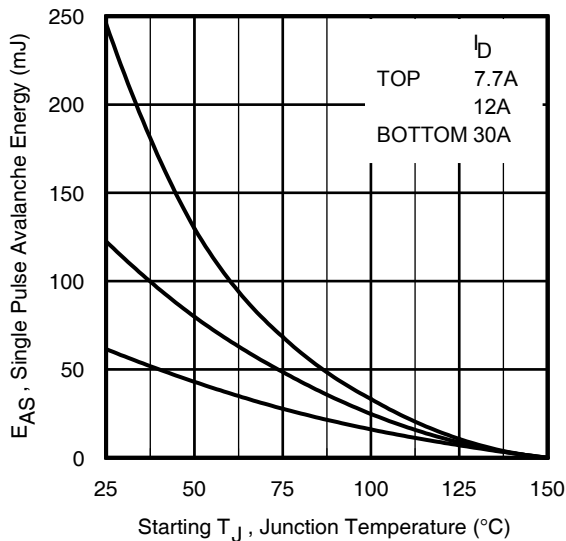
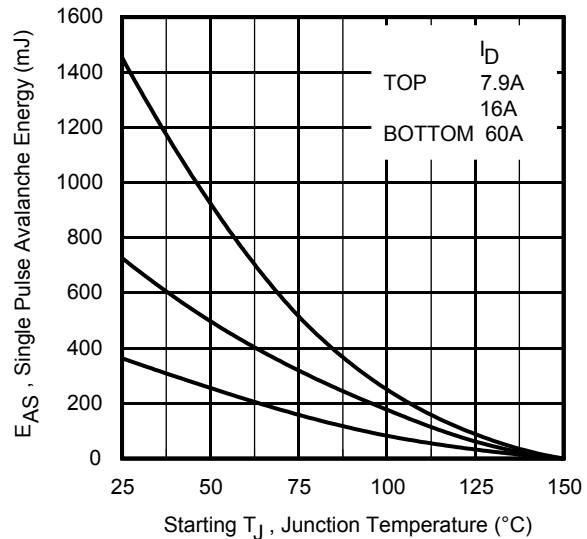
Fig 4. Typical Output Characteristics

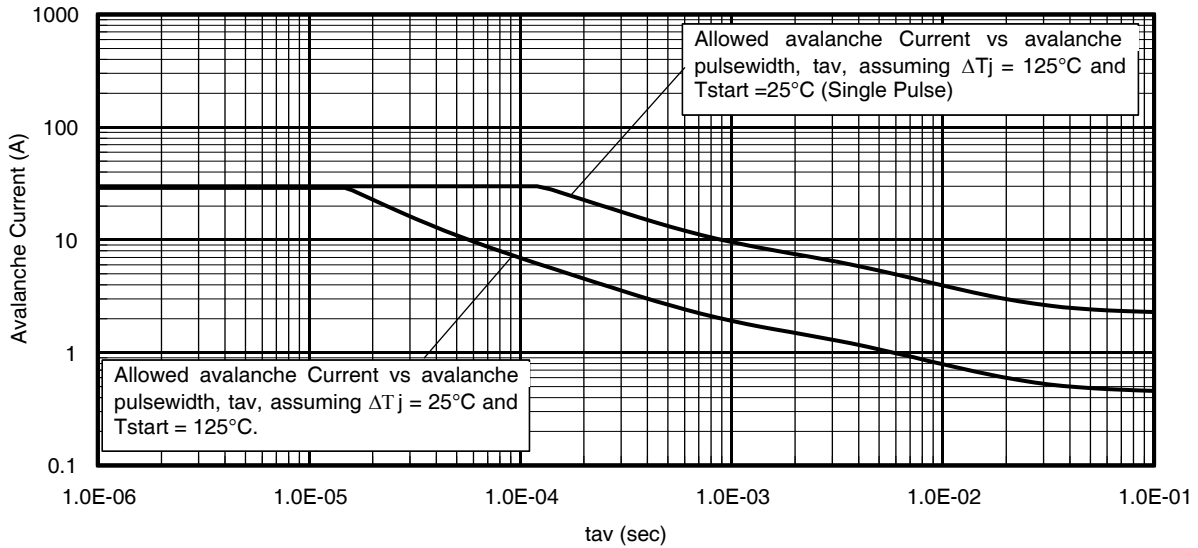
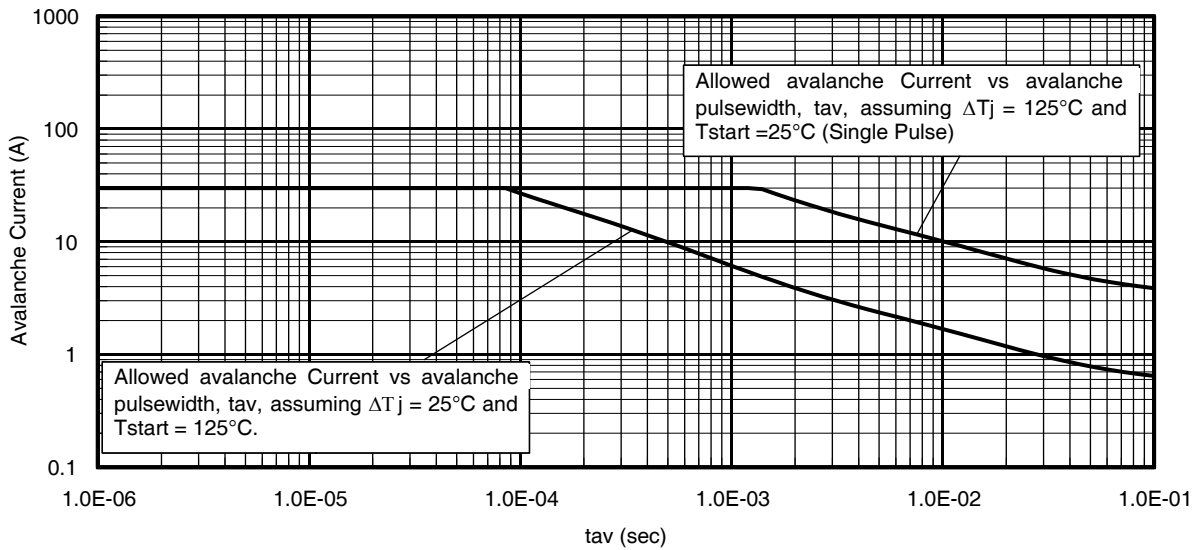
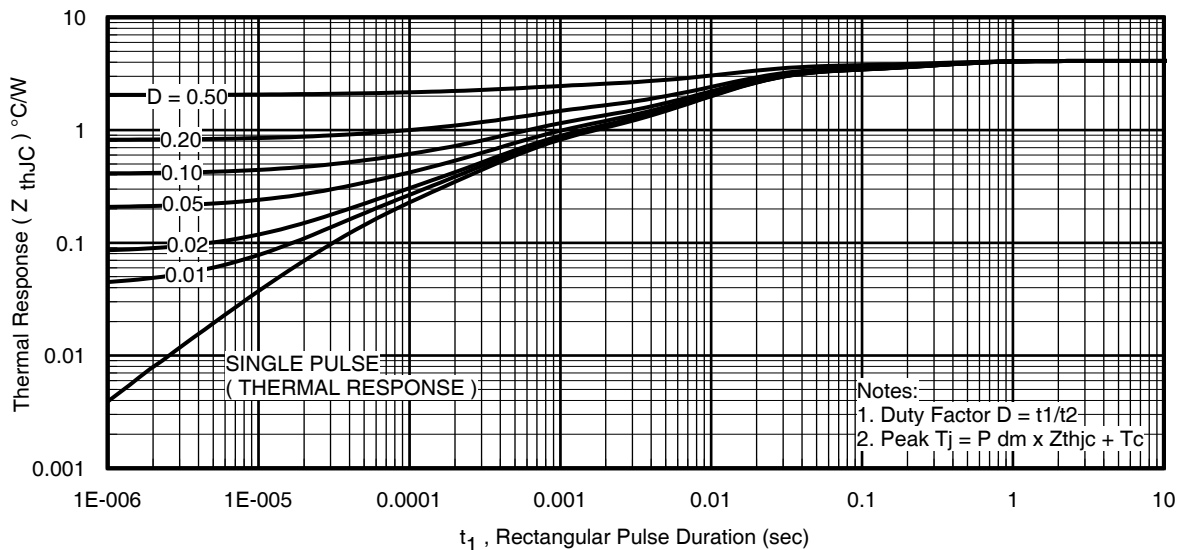
Fig 5. Typical Transfer Characteristics

Fig 6. Typical Transfer Characteristics

Q1 - Control FET

Fig 7. Typical Capacitance vs. Drain-to-Source Voltage
Q2 - Synchronous FET

Fig 8. Typical Capacitance vs. Drain-to-Source Voltage

Fig 9. Typical Gate Charge vs. Gate-to-Source Voltage

Fig 10. Typical Gate Charge vs. Gate-to-Source Voltage

Fig 11. Maximum Safe Operating Area

Fig 12. Maximum Safe Operating Area

Fig 13. Normalized On-Resistance vs. Temperature

Fig 14. Normalized On-Resistance vs. Temperature

Fig 15. Typical Source-Drain Diode Forward Voltage

Fig 16. Typical Source-Drain Diode Forward Voltage

Fig 17. Typical On-Resistance vs. Gate Voltage

Fig 18. Typical On-Resistance vs. Gate Voltage

Q1 - Control FET

Fig 19. Maximum Drain Current vs. Case Temperature
Q2 - Synchronous FET

Fig 20. Maximum Drain Current vs. Case Temperature

Fig 21. Threshold Voltage vs. Temperature

Fig 22. Threshold Voltage vs. Temperature

Fig 23. Maximum Avalanche Energy vs. Drain Current

Fig 24. Maximum Avalanche Energy vs. Drain Current

Fig 25. Typical Avalanche Current vs. Pulse Width (Q1)

Fig 26. Typical Avalanche Current vs. Pulse Width (Q2)

Fig 27. Maximum Effective Transient Thermal Impedance, Junction-to-Case (Q1)

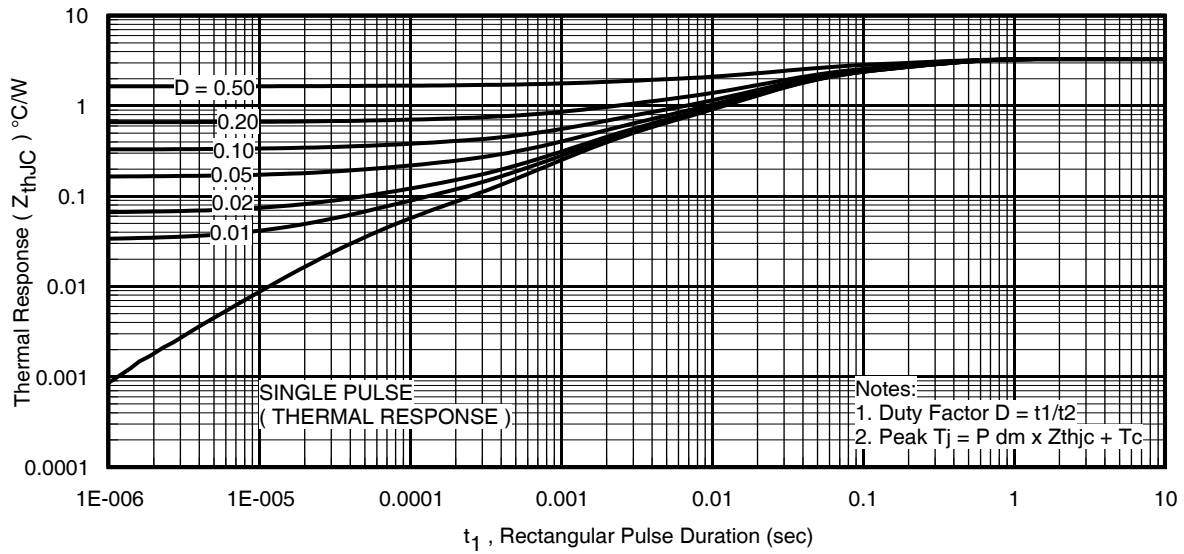
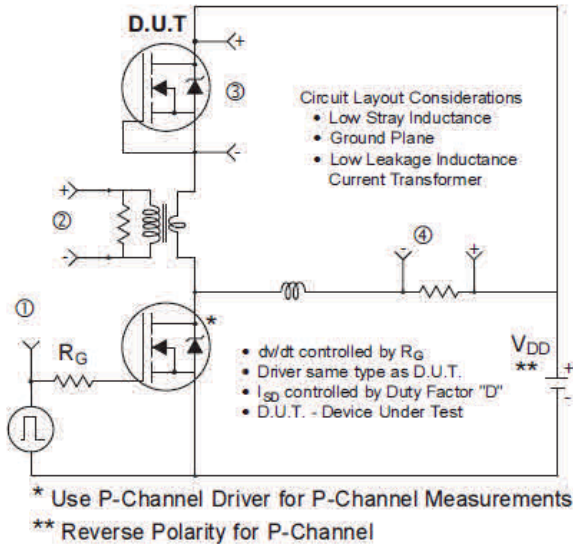
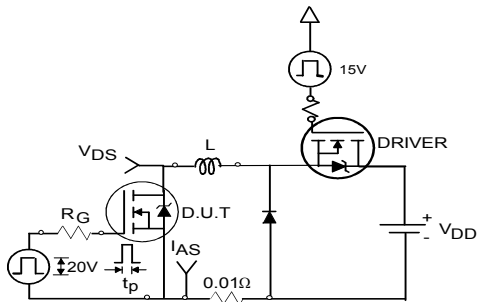
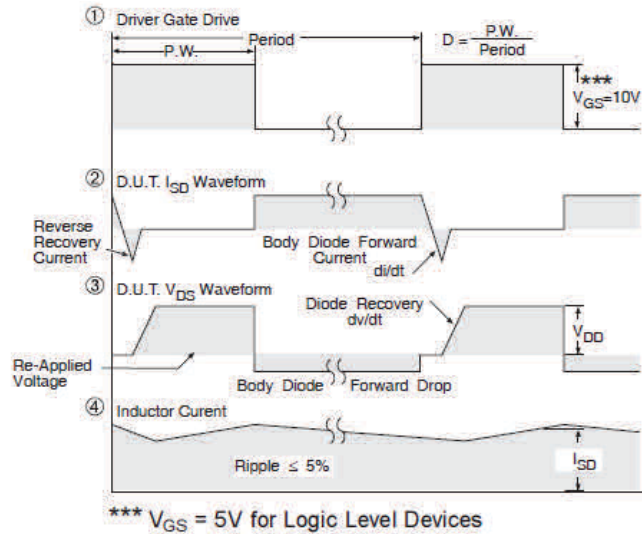
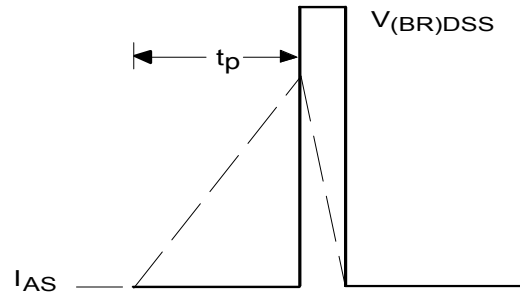
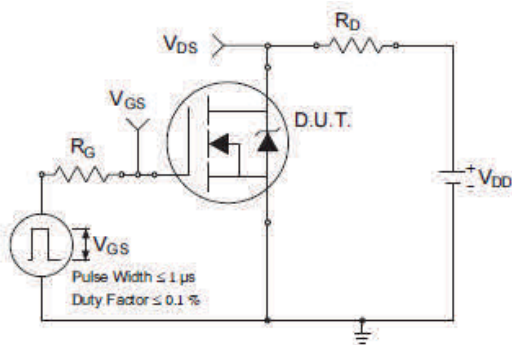
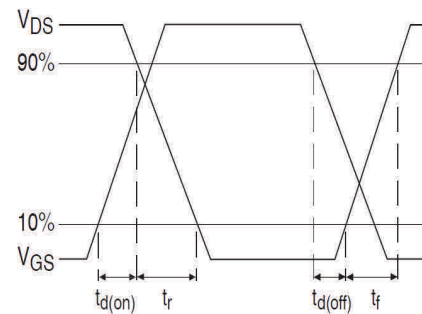
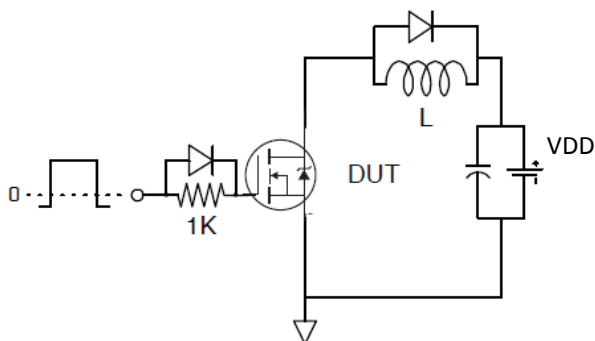
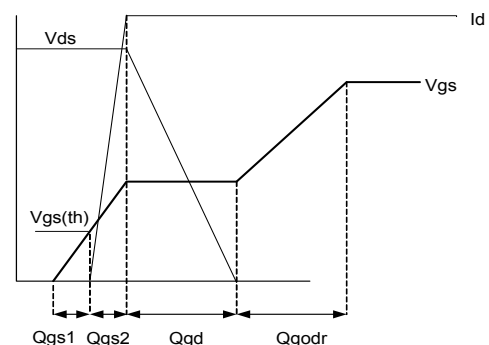
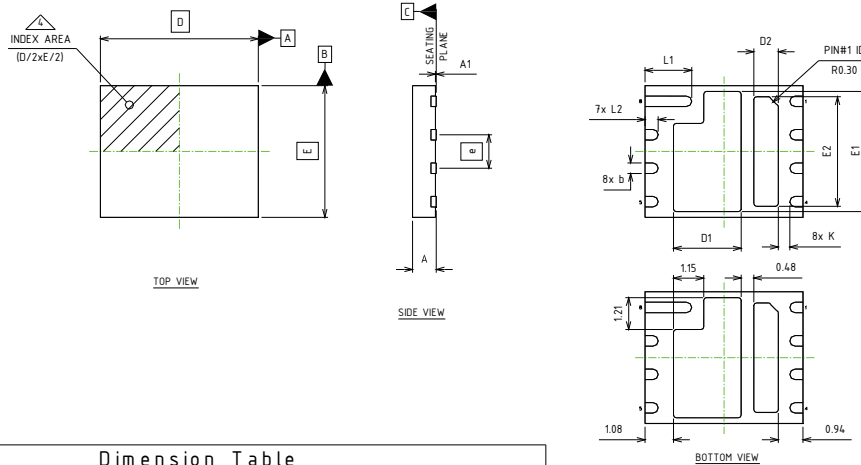
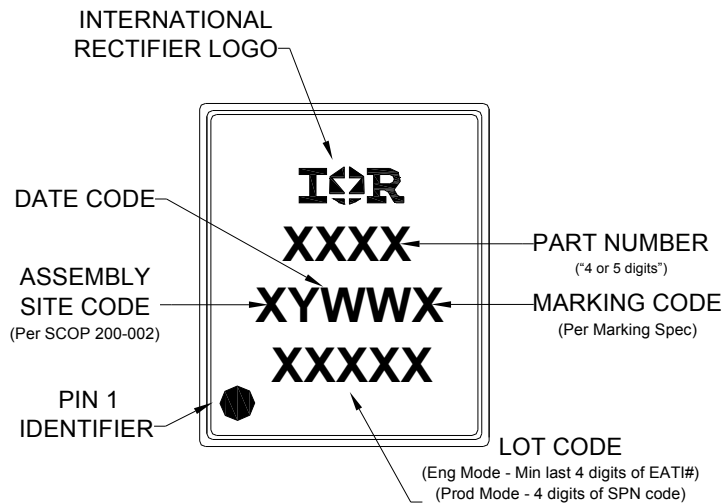

Fig 28. Maximum Effective Transient Thermal Impedance, Junction-to-Case (Q2)

Fig 29. Peak Diode Recovery dv/dt Test Circuit for N-Channel HEXFET[®] Power MOSFETs

Fig 30a. Unclamped Inductive Test Circuit

Fig 30b. Unclamped Inductive Waveforms

Fig 31a. Switching Time Test Circuit

Fig 31b. Switching Time Waveforms

Fig 32a. Gate Charge Test Circuit

Fig 32b. Gate Charge Waveform

Dual PQFN 5x6 Outline “H” Package Details

Dimension Table				
Thickness Symbol	V : Very Thin			NOTE
	MINIMUM	NOMINAL	MAXIMUM	
A	0.80	0.90	1.00	
A1	0.00	0.02	0.05	
b	0.30	0.40	0.50	6
D	6.00 BSC			
E	5.00 BSC			
e	1.27 BSC			
D1	2.42	2.57	2.67	
E1	4.41	4.56	4.66	
D2	0.78	0.93	1.03	
E2	4.01	4.16	4.26	
K	0.20	---	---	
L1	1.67	1.77	1.87	
L2	0.40	0.50	0.60	

Dual PQFN 5x6 Outline “H” Part Marking

For more information on board mounting, including footprint and stencil recommendation, please refer to application note AN-1136: <http://www.irf.com/technical-info/appnotes/an-1136.pdf>

For more information on package inspection techniques, please refer to application note AN-1154: <http://www.irf.com/technical-info/appnotes/an-1154.pdf>

Note: For the most current drawing please refer to IR website at <http://www.irf.com/package/>

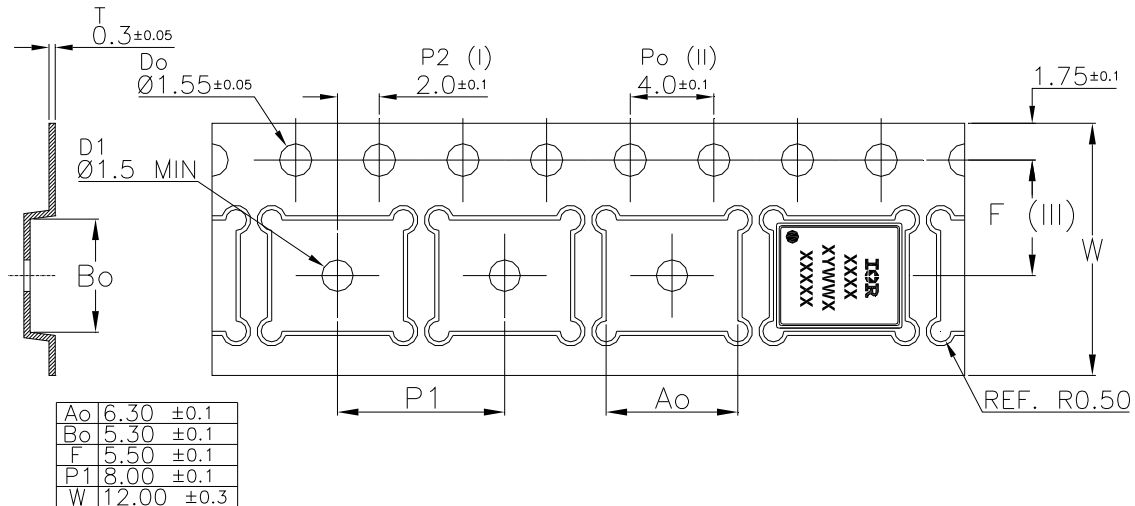
Dual PQFN 5x6 Outline Tape and Reel

Note: For the most current drawing please refer to IR website at <http://www.irf.com/package/>

Qualification Information†

Qualification level	Industrial (per JEDEC JESD47F †† guidelines)	
Moisture Sensitivity Level	DUAL PQFN 5mm x 6mm	MSL1 (per JEDEC J-STD-020D††)
RoHS Compliant	Yes	

† Qualification standards can be found at International Rectifier's web site <http://www.irf.com/product-info/reliability>

†† Applicable version of JEDEC standard at the time of product release.

Notes:

- ① Repetitive rating; pulse width limited by max. junction temperature.
- ② Starting $T_J = 25^\circ\text{C}$,
Q1: $L = 0.14\text{mH}$, $R_G = 50\Omega$, $I_{AS} = 30\text{A}$;
Q2: $L = 0.20\text{mH}$, $R_G = 50\Omega$, $I_{AS} = 60\text{A}$.
- ③ Pulse width $\leq 400\mu\text{s}$; duty cycle $\leq 2\%$.
- ④ R_θ is measured at T_J approximately 90°C .
- ⑤ When mounted on 1 inch square PCB (FR-4). Please refer to AN-994 for more details:
<http://www.irf.com/technical-info/appnotes/an-994.pdf>
- ⑥ Calculated continuous current based on maximum allowable junction temperature.
- ⑦ Current is limited to Q1 = 30A & Q2 = 30A by source bonding technology.
- ⑧ Pulsed drain current is limited to 120A by source bonding technology.

Revision History

Date	Comments
01/27/2014	• Update the MSL level from MSL2 to MSL1, on page 1 & 12.
04/08/2014	• Removed "redundant" information of IDSS Q1 & Q2 on page 2.

International
 Rectifier

IR WORLD HEADQUARTERS: 101 N. Sepulveda Blvd., El Segundo, California 90245, USA

To contact International Rectifier, please visit <http://www.irf.com/whoto-call/>