



Chipsmall Limited consists of a professional team with an average of over 10 year of expertise in the distribution of electronic components. Based in Hongkong, we have already established firm and mutual-benefit business relationships with customers from,Europe,America and south Asia,supplying obsolete and hard-to-find components to meet their specific needs.

With the principle of “Quality Parts,Customers Priority,Honest Operation,and Considerate Service”,our business mainly focus on the distribution of electronic components. Line cards we deal with include Microchip,ALPS,ROHM,Xilinx,Pulse,ON,Everlight and Freescale. Main products comprise IC,Modules,Potentiometer,IC Socket,Relay,Connector.Our parts cover such applications as commercial,industrial, and automotives areas.

We are looking forward to setting up business relationship with you and hope to provide you with the best service and solution. Let us make a better world for our industry!



Contact us

Tel: +86-755-8981 8866 Fax: +86-755-8427 6832

Email & Skype: info@chipsmall.com Web: www.chipsmall.com

Address: A1208, Overseas Decoration Building, #122 Zhenhua RD., Futian, Shenzhen, China



V_{DS}	-30	V
$V_{GS\ max}$	±20	V
$R_{DS(on)\ max}$ (@ $V_{GS} = -10V$)	170	mΩ
I_D (@ $T_C = 25^\circ C$)	-3.4 ②	A

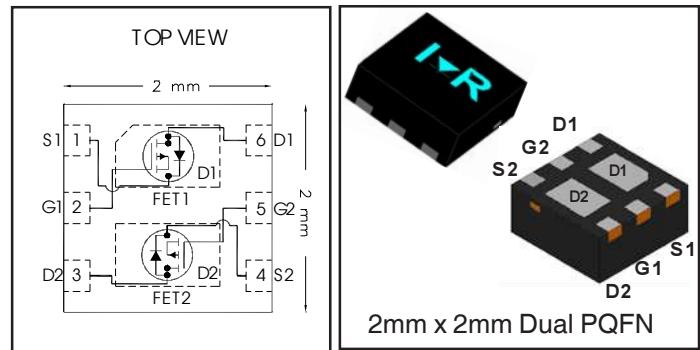

Applications

- Charge and Discharge Switch for Battery Application
- System/load switch

Features and Benefits

Features

Low $R_{DS(on)}$ ($\leq 170m\Omega$)
Low Thermal Resistance to PCB ($\leq 19^\circ C/W$)
Low Profile ($\leq 1.0\ mm$)
Compatible with Existing Surface Mount Techniques
RoHS Compliant Containing no Lead, no Bromide and no Halogen
MSL1, Industrial Qualification

results in

Benefits

Lower Conduction Losses
Enable better thermal dissipation
Increased Power Density
Easier Manufacturing
Environmentally Friendlier
Increased Reliability

Orderable part number	Package Type	Standard Pack		Note
		Form	Quantity	
IRFHS9351TRPBF	PQFN 2mm x 2mm	Tape and Reel	4000	
IRFHS9351TR2PBF	PQFN 2mm x 2mm	Tape and Reel	400	EOL notice # 259

Absolute Maximum Ratings

	Parameter	Max.	Units
V_{DS}	Drain-to-Source Voltage	-30	V
V_{GS}	Gate-to-Source Voltage	± 20	
$I_D @ T_A = 25^\circ C$	Continuous Drain Current, $V_{GS} @ -10V$	-2.3	A
$I_D @ T_A = 70^\circ C$	Continuous Drain Current, $V_{GS} @ -10V$	-1.5	
$I_D @ T_C = 25^\circ C$	Continuous Drain Current, $V_{GS} @ -10V$	-5.1 ②	
$I_D @ T_C = 70^\circ C$	Continuous Drain Current, $V_{GS} @ -10V$	-4.1 ②	
$I_D @ T_C = 25^\circ C$	Continuous Drain Current, $V_{GS} @ 10V$ (Package Limited)	-3.4 ②	
I_{DM}	Pulsed Drain Current ①	-20	
$P_D @ T_A = 25^\circ C$	Power Dissipation ④	1.4	
$P_D @ T_A = 70^\circ C$	Power Dissipation ④	0.9	
	Linear Derating Factor	0.01	W/°C
T_J T_{STG}	Operating Junction and Storage Temperature Range	-55 to + 150	°C

Notes ① through ⑥ are on page 2

Static @ $T_J = 25^\circ\text{C}$ (unless otherwise specified)

	Parameter	Min.	Typ.	Max.	Units	Conditions
BV_{DSS}	Drain-to-Source Breakdown Voltage	-30	—	—	V	$V_{GS} = 0V, I_D = -250\mu A$
V_{DSS}/T_J	Breakdown Voltage Temp. Coefficient	—	0.02	—	V/ $^\circ\text{C}$	Reference to $25^\circ\text{C}, I_D = -1\text{mA}$
$R_{DS(on)}$	Static Drain-to-Source On-Resistance	—	135	170	m	$V_{GS} = -10V, I_D = -3.1A$ ③
		—	235	290		$V_{GS} = -4.5V, I_D = -2.5A$ ③
$V_{GS(th)}$	Gate Threshold Voltage	-1.3	-1.8	-2.4	V	$V_{DS} = V_{GS}, I_D = -10\mu A$
$V_{GS(th)}$	Gate Threshold Voltage Coefficient	—	-4.6	—	mV/ $^\circ\text{C}$	
I_{DSS}	Drain-to-Source Leakage Current	—	—	-1.0	μA	$V_{DS} = -24V, V_{GS} = 0V$
		—	—	-150		$V_{DS} = -24V, V_{GS} = 0V, T_J = 125^\circ\text{C}$
I_{GSS}	Gate-to-Source Forward Leakage	—	—	-100	nA	$V_{GS} = -20V$
	Gate-to-Source Reverse Leakage	—	—	100		$V_{GS} = 20V$
g_{fs}	Forward Transconductance	2.4	—	—	S	$V_{DS} = -10V, I_D = -3.1A$
Q_g	Total Gate Charge ⑥	—	1.9	—	nC	$V_{DS} = -15V, V_{GS} = -4.5V, I_D = -3.1A$
Q_g	Total Gate Charge ⑥	—	3.7	—	nC	$V_{GS} = -10V$
Q_{gs}	Gate-to-Source Charge ⑥	—	0.6	—		$V_{DS} = -15V$
Q_{gd}	Gate-to-Drain Charge ⑥	—	1.1	—		$I_D = -3.1A$
R_G	Gate Resistance ⑥	—	17	—		
$t_{d(on)}$	Turn-On Delay Time	—	8.3	—	ns	$V_{DD} = -15V, V_{GS} = -4.5V$ ③
t_r	Rise Time	—	30	—		$I_D = -3.1A$
$t_{d(off)}$	Turn-Off Delay Time	—	6.3	—		$R_G = 1.8$
t_f	Fall Time	—	7.9	—		See Figs. 19a & 19b
C_{iss}	Input Capacitance	—	160	—	pF	$V_{GS} = 0V$
C_{oss}	Output Capacitance	—	39	—		$V_{DS} = -25V$
C_{rss}	Reverse Transfer Capacitance	—	26	—		$f = 1.0\text{KHz}$

Diode Characteristics

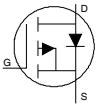
	Parameter	Min.	Typ.	Max.	Units	Conditions
I_S	Continuous Source Current (Body Diode)	—	—	-5.1	A	MOSFET symbol showing the integral reverse p-n junction diode. 
I_{SM}	Pulsed Source Current (Body Diode) ①	—	—	-20		
V_{SD}	Diode Forward Voltage	—	—	-1.2	V	$T_J = 25^\circ\text{C}, I_S = -3.1A, V_{GS} = 0V$ ③
t_{rr}	Reverse Recovery Time	—	20	30	ns	$T_J = 25^\circ\text{C}, I_F = -3.1A, V_{DD} = -15V$
Q_{rr}	Reverse Recovery Charge	—	42	63	nC	$di/dt = 370/\mu s$ ③

Thermal Resistance

	Parameter	Typ.	Max.	Units
R_{JC} (Bottom)	Junction-to-Case ②	—	19	$^\circ\text{C/W}$
R_{JC} (Top)	Junction-to-Case ②	—	170	
R_{JA}	Junction-to-Ambient ④	—	90	
R_{JA}	Junction-to-Ambient ($t < 10s$) ④	—	75	

Notes:

- ① Repetitive rating; pulse width limited by max. junction temperature.
- ② Current limited by package. .
- ③ Pulse width $\leq 400\mu s$; duty cycle $\leq 2\%$.
- ④ When mounted on 1 inch square copper board.
- ⑤ R_{θ} is measured at T_J of approximately 90°C .
- ⑥ For DESIGN AID ONLY, not subject to production testing.

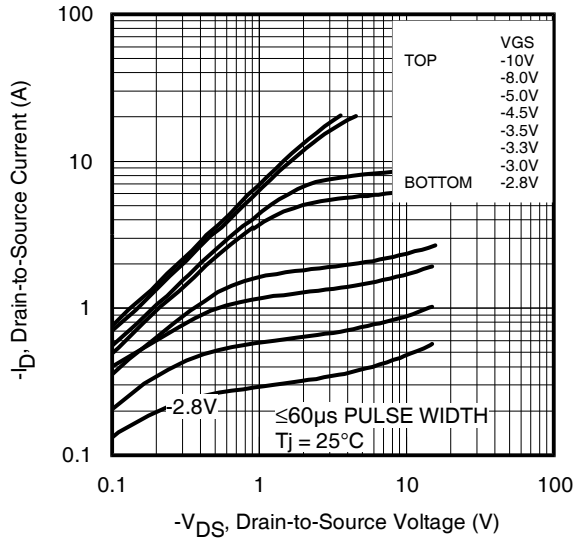
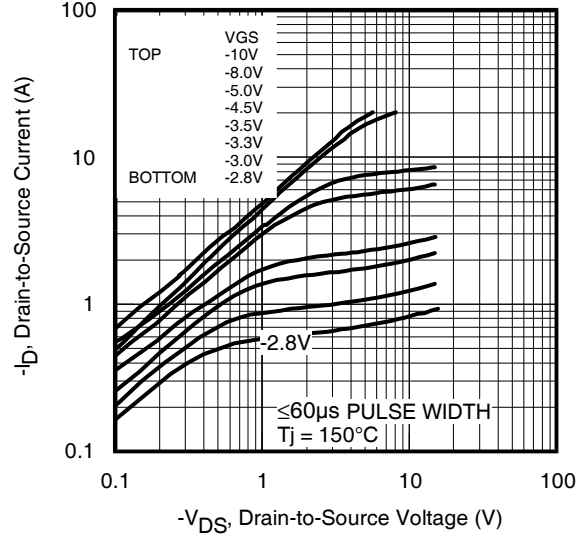
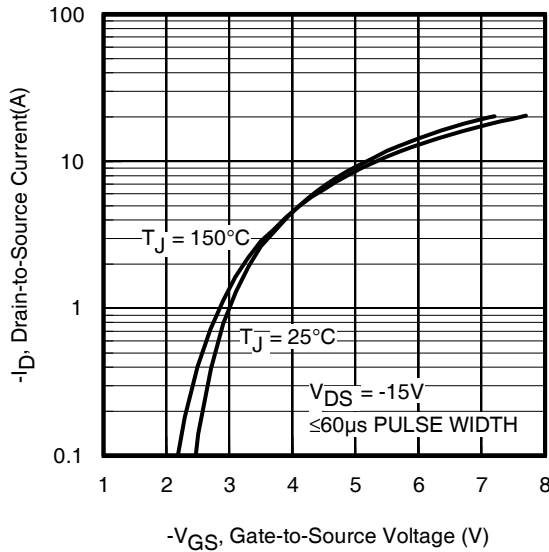
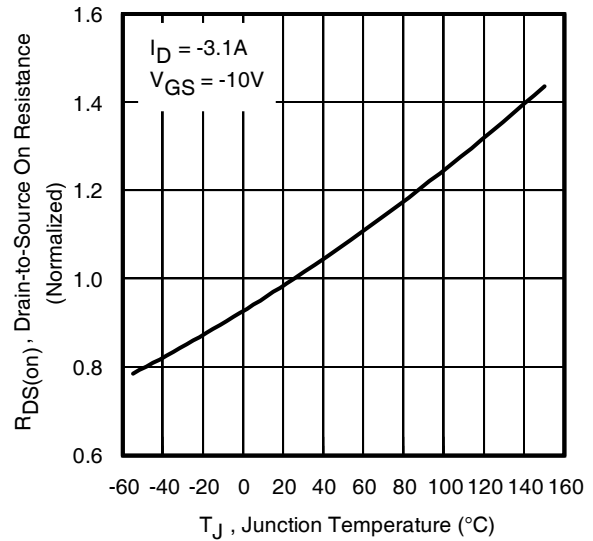
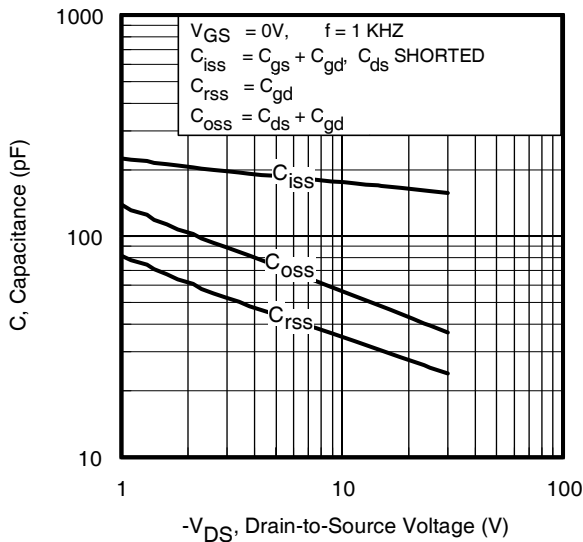
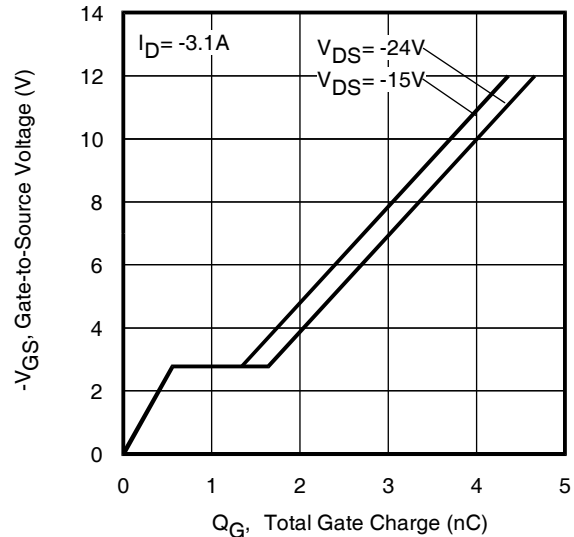
Fig 1. Typical Output Characteristics

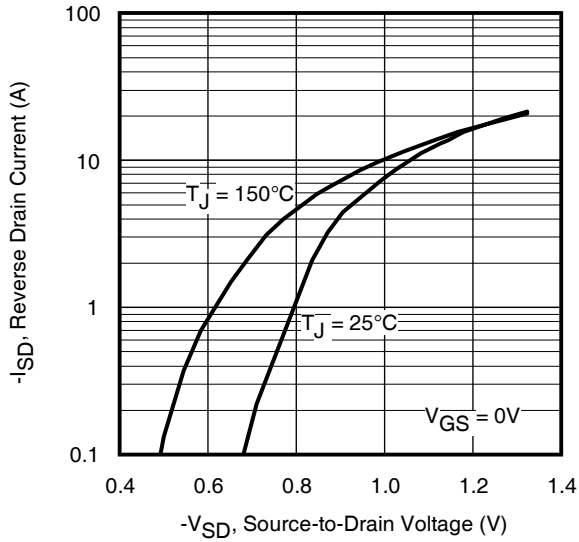
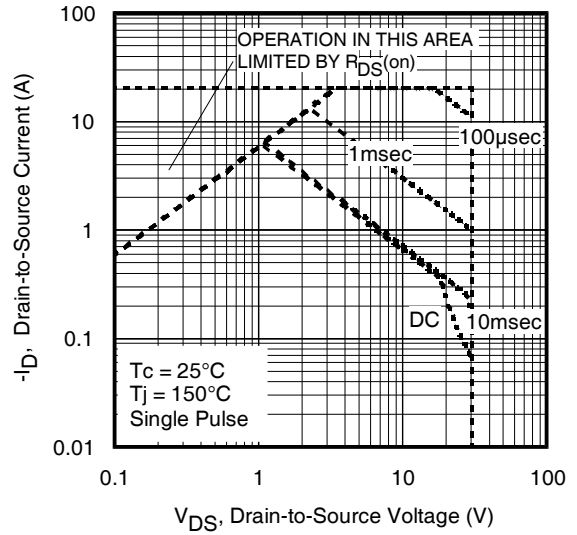
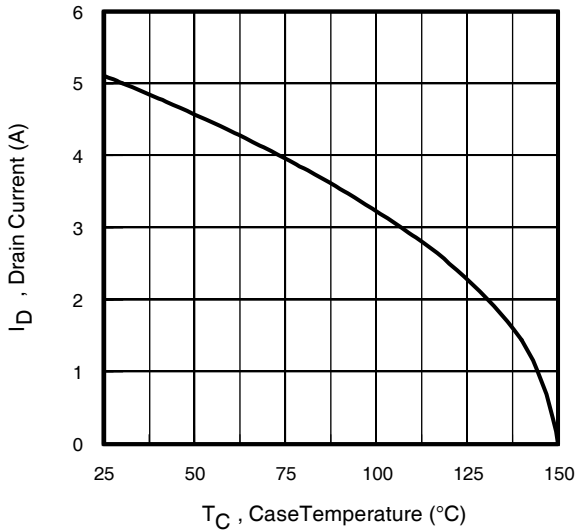
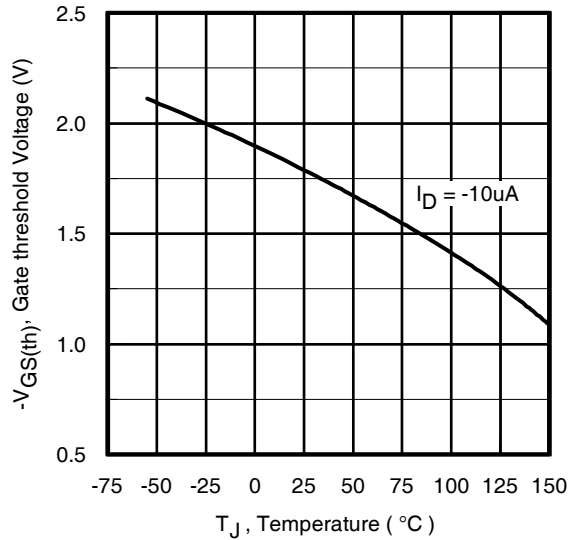
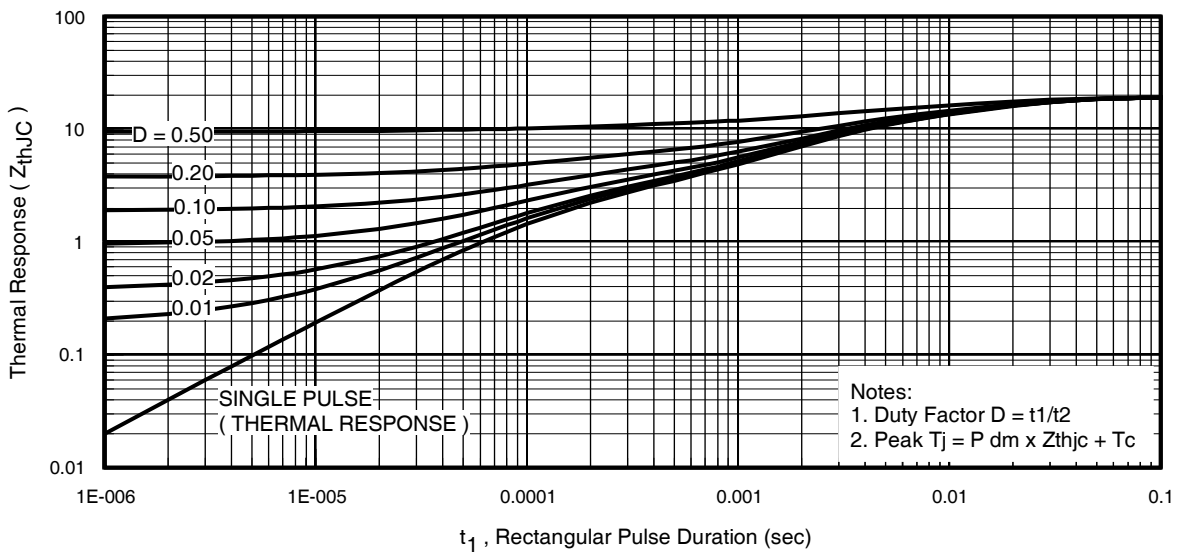
Fig 2. Typical Output Characteristics

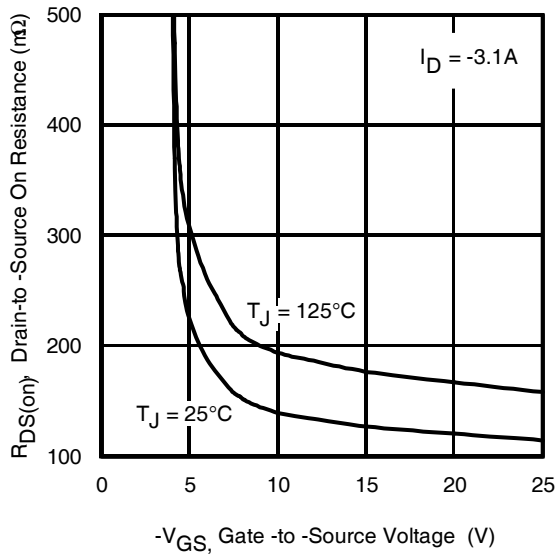
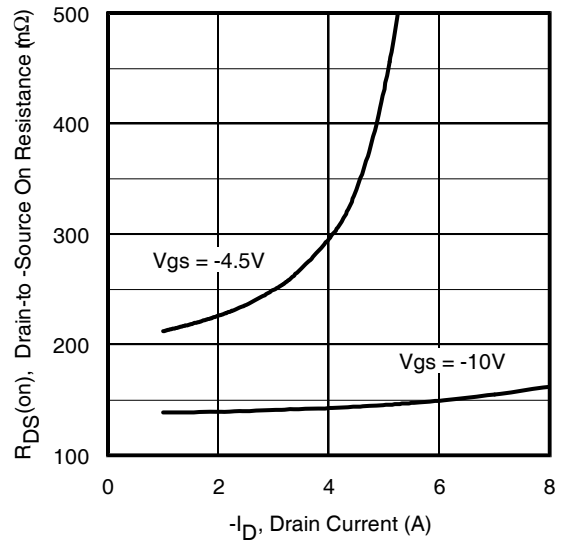
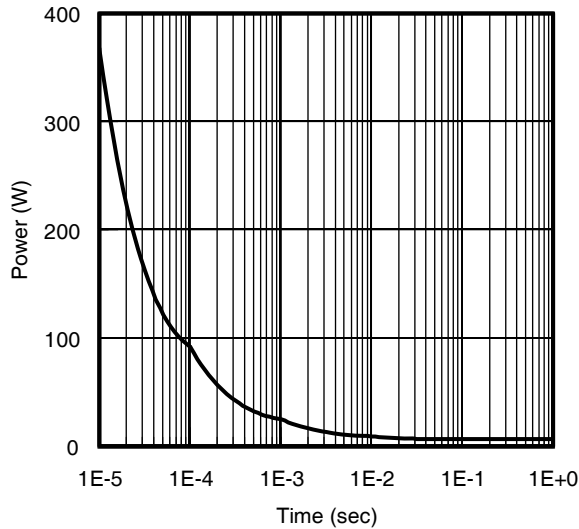
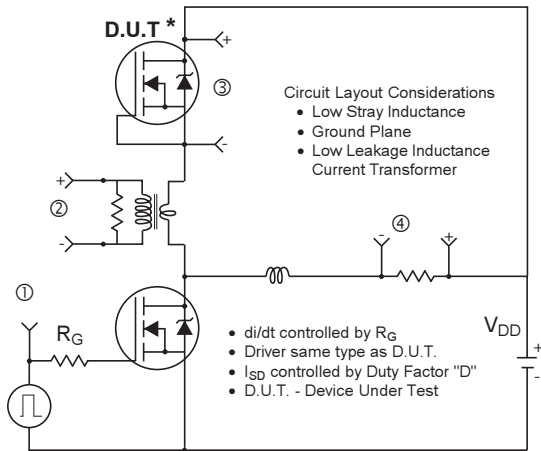
Fig 3. Typical Transfer Characteristics

Fig 4. Normalized On-Resistance vs. Temperature

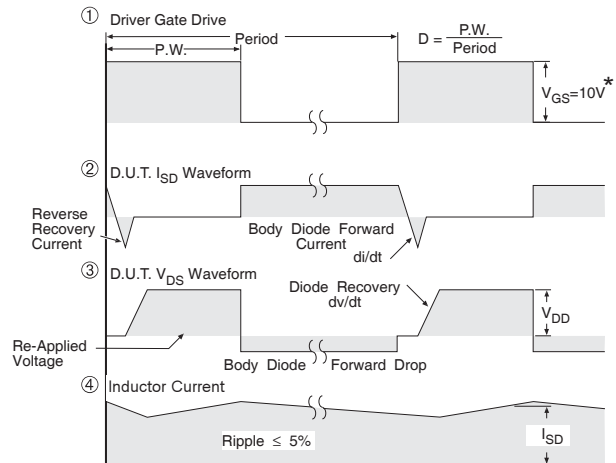
Fig 5. Typical Capacitance vs. Drain-to-Source Voltage

Fig 6. Typical Gate Charge vs. Gate-to-Source Voltage

Fig 7. Typical Source-Drain Diode Forward Voltage

Fig 8. Maximum Safe Operating Area

Fig 9. Maximum Drain Current vs. Case Temperature

Fig 10. Threshold Voltage vs. Temperature

Fig 11. Maximum Effective Transient Thermal Impedance, Junction-to-Case

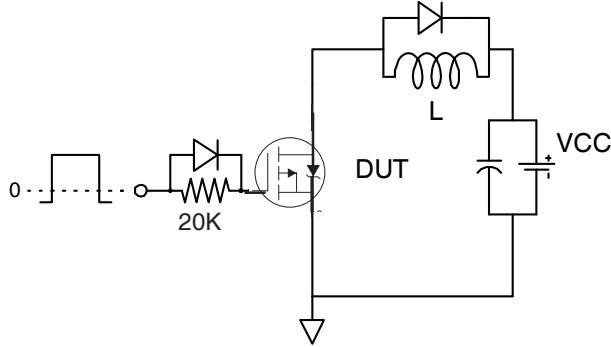
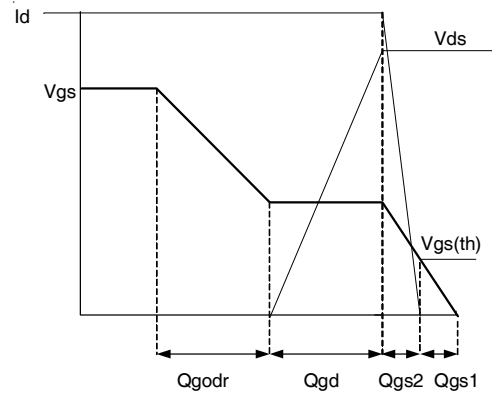
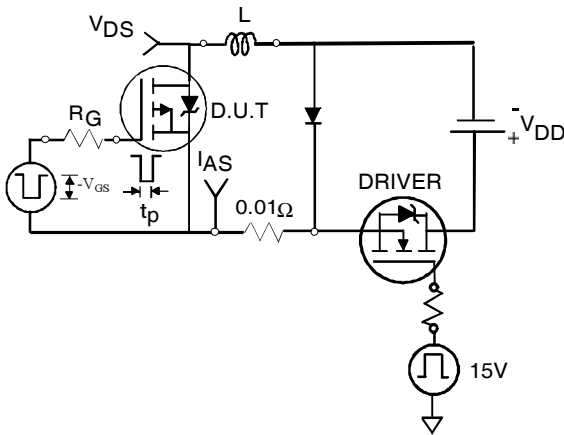
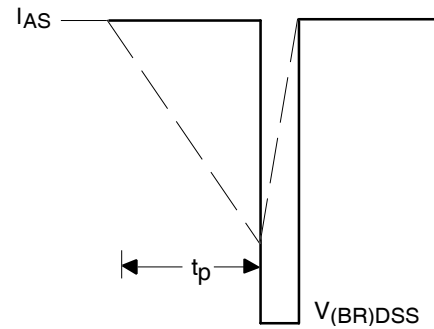
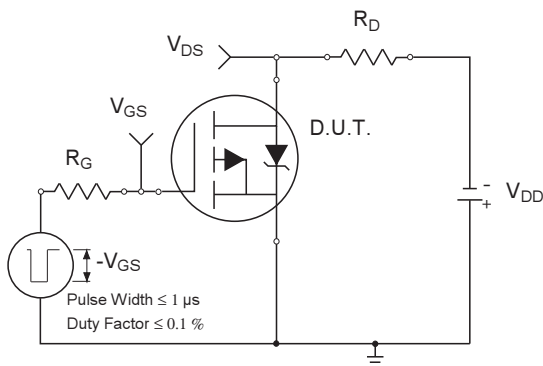
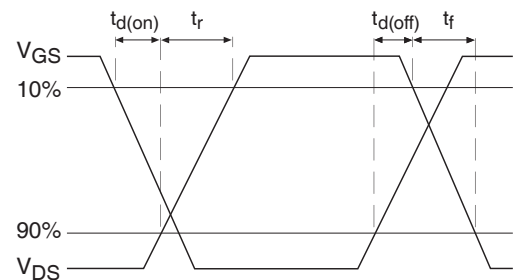

Fig 12. On-Resistance vs. Gate Voltage

Fig 13. Typical On-Resistance vs. Drain Current

Fig 14. Typical Power vs. Time

* Reverse Polarity of D.U.T. for P-Channel



* $V_{GS} = 5V$ for Logic Level Devices

Fig 15. Diode Reverse Recovery Test Circuit for P-Channel HEXFET® Power MOSFETs

Fig 16a. Gate Charge Test Circuit

Fig 16b. Gate Charge Waveform

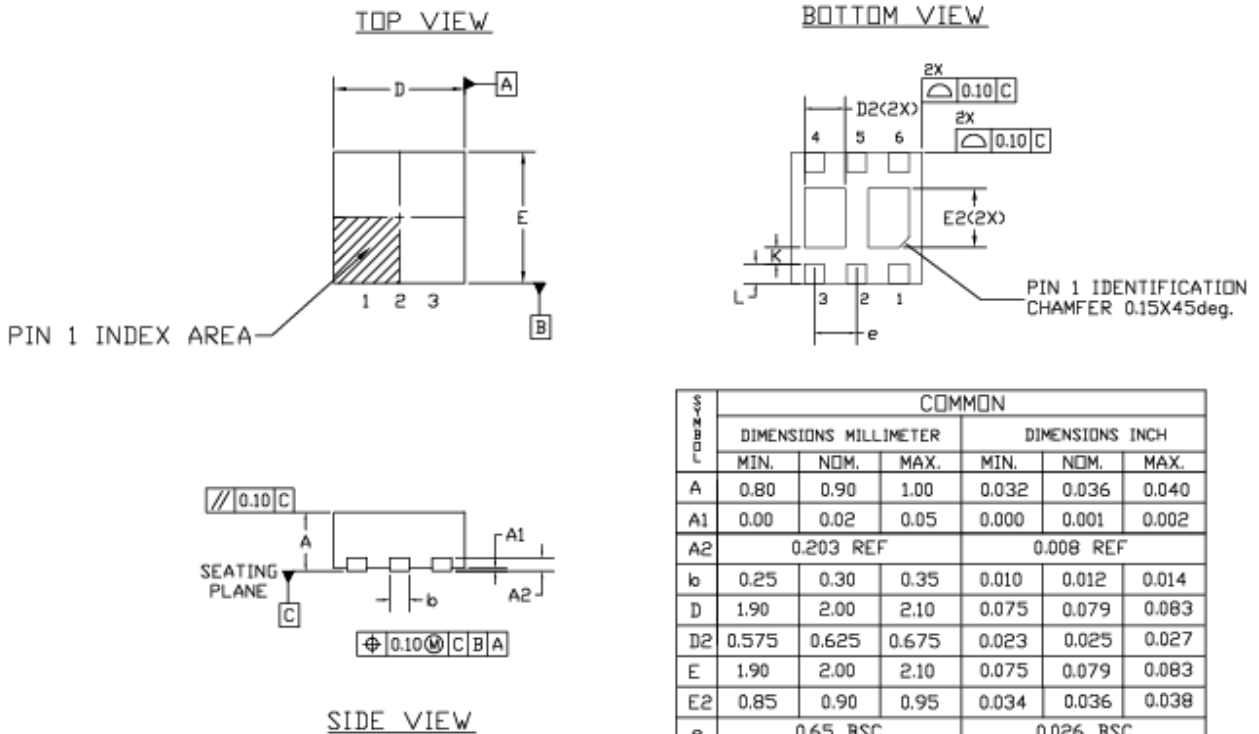
Fig 17a. Unclamped Inductive Test Circuit

Fig 17b. Unclamped Inductive Waveforms

Fig 18a. Switching Time Test Circuit

Fig 18b. Switching Time Waveforms

PQFN Package Details



NOTES :

1. DIMENSION AND TOLERANCING CONFORM TO ASME Y14.5M-1994.
2. CONTROLLING DIMENSIONS : MILLIMETER. CONVERTED INCH DIMENSION ARE NOT NECESSARILY EXACT.

PQFN Part Marking

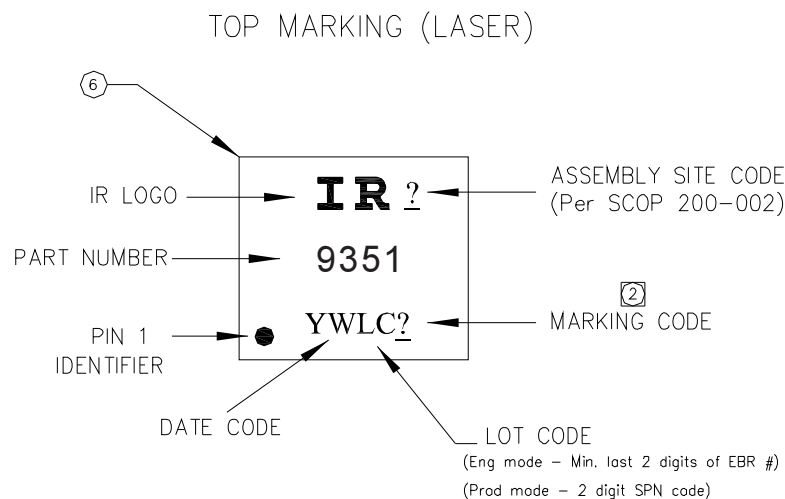

Note: For the most current drawing please refer to IR website at: <http://www.irf.com/package/>

PQFN Tape and Reel

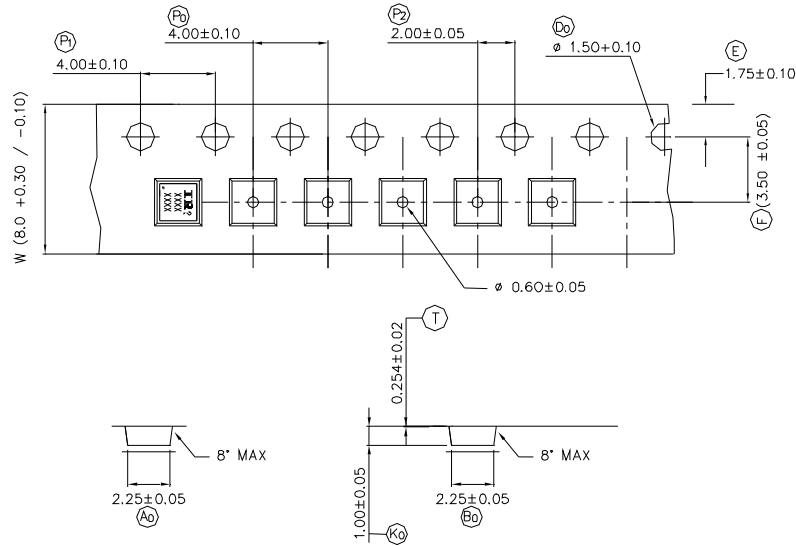

NOTE: The Surface Resistivity is $10^4 - 10^8$ OHM/SQ

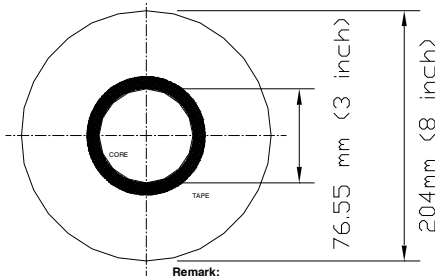
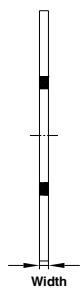

Remark:
 - Dimension above are typical dimensions.
 - Cover tape thickness is 0.043mm +/- 0.005mm.
 - Surface resistivity $10E5 < R_s < 10E8$.

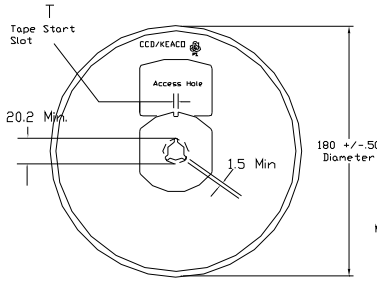

FRONT VIEW

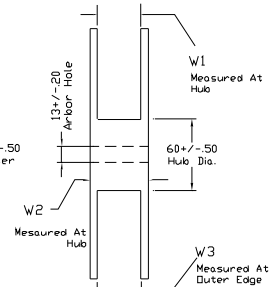

SIDE VIEW

COVER TAPE (WIDTH)	TOLERANCE
5.4 mm	+/- 0.1 mm
9.5 mm	+/- 0.1 mm

TAPE WIDTH	T	W1	W2	W3	PART NO
8 MM	3 ± 0.50	8.4 ^{+1.5} _{-0.0}	14.4 Max	7.90 Min 10.9 Max	91586-1
12 MM	3 ± 0.50	12.4 ^{+2.0} _{-0.0}	18.4 Max	11.9 Min 15.4 Max	91586-2

Note: Surface resistivity is $\geq 1 \times 10^5$ but $< 1 \times 10^{12}$ ohm/sq.

Note: For the most current drawing please refer to IR website at: <http://www.irf.com/package/>

Qualification information[†]

Qualification level	Industrial ^{††} (per JEDEC JESD47F ^{†††} guidelines)	
Moisture Sensitivity Level	PQFN 2mm x 2mm	MSL1 (per IPC/JEDEC J-STD-020D ^{†††})
RoHS compliant	Yes	

† Qualification standards can be found at International Rectifier's web site

<http://www.irf.com/product-info/reliability>

†† Higher qualification ratings may be available should the user have such requirements.

Please contact your International Rectifier sales representative for further information:

<http://www.irf.com/whoto-call/salesrep/>

††† Applicable version of JEDEC standard at the time of product release.

Revision History

Date	Comment
5/13/2014	<ul style="list-style-type: none"> Updated ordering information to reflect the End-Of-life (EOL) of the mini-reel option (EOL notice #259) Updated data sheet based on corporate template.
5/21/2014	<ul style="list-style-type: none"> Updated qual level from "Consumer" to "Industrial" on page 1 & 9.