



Chipsmall Limited consists of a professional team with an average of over 10 year of expertise in the distribution of electronic components. Based in Hongkong, we have already established firm and mutual-benefit business relationships with customers from,Europe,America and south Asia,supplying obsolete and hard-to-find components to meet their specific needs.

With the principle of “Quality Parts,Customers Priority,Honest Operation,and Considerate Service”,our business mainly focus on the distribution of electronic components. Line cards we deal with include Microchip,ALPS,ROHM,Xilinx,Pulse,ON,Everlight and Freescale. Main products comprise IC,Modules,Potentiometer,IC Socket,Relay,Connector.Our parts cover such applications as commercial,industrial, and automotives areas.

We are looking forward to setting up business relationship with you and hope to provide you with the best service and solution. Let us make a better world for our industry!



Contact us

Tel: +86-755-8981 8866 Fax: +86-755-8427 6832

Email & Skype: info@chipsmall.com Web: www.chipsmall.com

Address: A1208, Overseas Decoration Building, #122 Zhenhua RD., Futian, Shenzhen, China



HEXFET® Power MOSFET

Applications

- Synchronous Rectification
- Active ORing

| V_{DSS} | $R_{DS(on) \max}$ | I_D |
|-----------|-------------------|-------------------|
| 30V | 0.0028Ω | 210A ^⑥ |

Benefits

- Ultra Low On-Resistance
- Low Gate Impedance to Reduce Switching Losses
- Fully Avalanche Rated



Absolute Maximum Ratings

| | Parameter | Max. | Units |
|---------------------------------|---|------------------|-------|
| $I_D @ T_C = 25^\circ\text{C}$ | Continuous Drain Current, $V_{GS} @ 10\text{V}$ | 210 ^⑥ | A |
| $I_D @ T_C = 100^\circ\text{C}$ | Continuous Drain Current, $V_{GS} @ 10\text{V}$ | 100 ^⑥ | |
| I_{DM} | Pulsed Drain Current ^① | 1000 | |
| $P_D @ T_C = 25^\circ\text{C}$ | Power Dissipation | 230 | W |
| $P_D @ T_A = 25^\circ\text{C}$ | Power Dissipation | 3.8 | |
| | Linear Derating Factor | 1.5 | W/°C |
| V_{GS} | Gate-to-Source Voltage | ± 20 | V |
| dv/dt | Peak Diode Recovery dv/dt ^③ | 5.0 | V/ns |
| T_J, T_{STG} | Junction and Storage Temperature Range | -55 to + 175 | °C |

Thermal Resistance

| | Parameter | Typ. | Max. | Units |
|-----------------|-------------------------------------|------|------|-------|
| $R_{\theta JC}$ | Junction-to-Case | — | 0.65 | °C/W |
| $R_{\theta CS}$ | Case-to-Sink, Flat, Greased Surface | 0.24 | — | |
| $R_{\theta JA}$ | Junction-to-Ambient | — | 40 | |

Typical SMPS Topologies

- Forward and Bridge Converters with Synchronous Rectification for Telecom and Industrial Applications
- Offline High Power AC/DC Convertors using Synchronous Rectification

Notes ^① through ^⑥ are on page 8

www.irf.com

IRFP3703

International
IR Rectifier

Static @ T_J = 25°C (unless otherwise specified)

| | Parameter | Min. | Typ. | Max. | Units | Conditions |
|--|--------------------------------------|------|-------|------|-------|---|
| V _{(BR)DSS} | Drain-to-Source Breakdown Voltage | 30 | — | — | V | V _{GS} = 0V, I _D = 250μA |
| ΔV _{(BR)DSS} /ΔT _J | Breakdown Voltage Temp. Coefficient | — | 0.028 | — | V/°C | Reference to 25°C, I _D = 1mA |
| R _{DS(on)} | Static Drain-to-Source On-Resistance | — | 2.3 | 2.8 | mΩ | V _{GS} = 10V, I _D = 76A ④ |
| | | — | 2.8 | 3.9 | | V _{GS} = 7.0V, I _D = 76A ④ |
| V _{GS(th)} | Gate Threshold Voltage | 2.0 | — | 4.0 | V | V _{DS} = V _{GS} , I _D = 250μA |
| I _{DSS} | Drain-to-Source Leakage Current | — | — | 20 | μA | V _{DS} = 24V, V _{GS} = 0V |
| | | — | — | 250 | | V _{DS} = 24V, V _{GS} = 0V, T _J = 150°C |
| I _{GSS} | Gate-to-Source Forward Leakage | — | — | 200 | nA | V _{GS} = 20V |
| | Gate-to-Source Reverse Leakage | — | — | -200 | | V _{GS} = -20V |

Dynamic @ T_J = 25°C (unless otherwise specified)

| | Parameter | Min. | Typ. | Max. | Units | Conditions |
|-----------------------|---------------------------------|------|-------|------|-------|--|
| g _{fs} | Forward Transconductance | 150 | — | — | S | V _{DS} = 24V, I _D = 76A |
| Q _g | Total Gate Charge | — | 209 | — | nC | I _D = 76A |
| Q _{gs} | Gate-to-Source Charge | — | 62 | — | | V _{DS} = 24V |
| Q _{gd} | Gate-to-Drain ("Miller") Charge | — | 42 | — | | V _{GS} = 10V, ④ |
| t _{d(on)} | Turn-On Delay Time | — | 18 | — | ns | V _{DD} = 15V, V _{GS} = 10V |
| t _r | Rise Time | — | 123 | — | | I _D = 76A |
| t _{d(off)} | Turn-Off Delay Time | — | 53 | — | | R _G = 1.8Ω |
| t _f | Fall Time | — | 24 | — | | V _{GS} = 10V ④ |
| C _{iss} | Input Capacitance | — | 8250 | — | pF | V _{GS} = 0V |
| C _{oss} | Output Capacitance | — | 3000 | — | | V _{DS} = 25V |
| C _{rss} | Reverse Transfer Capacitance | — | 290 | — | | f = 1.0MHz |
| C _{oss} | Output Capacitance | — | 10360 | — | | V _{GS} = 0V, V _{DS} = 1.0V, f = 1.0MHz |
| C _{oss} | Output Capacitance | — | 3060 | — | | V _{GS} = 0V, V _{DS} = 24V, f = 1.0MHz |
| C _{oss eff.} | Effective Output Capacitance | — | 2590 | — | | V _{GS} = 0V, V _{DS} = 0V to 24V ⑤ |

Avalanche Characteristics

| | Parameter | Typ. | Max. | Units |
|-----------------|--------------------------------|------|------|-------|
| E _{AS} | Single Pulse Avalanche Energy② | — | 1700 | mJ |
| I _{AR} | Avalanche Current③ | — | 76 | A |
| E _{AR} | Repetitive Avalanche Energy① | — | 23 | mJ |

Diode Characteristics

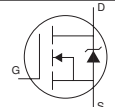
| | Parameter | Min. | Typ. | Max. | Units | Conditions |
|-----------------|--|------|------|------|-------|--|
| I _S | Continuous Source Current (Body Diode) | — | — | 210⑥ | A | MOSFET symbol showing the integral reverse p-n junction diode.  |
| I _{SM} | Pulsed Source Current (Body Diode) ① | — | — | 1000 | | |
| V _{SD} | Diode Forward Voltage | — | 0.8 | 1.3 | V | T _J = 25°C, I _S = 76A, V _{GS} = 0V ④ |
| t _{rr} | Reverse Recovery Time | — | 80 | 120 | ns | T _J = 25°C, I _F = 76A, V _{DS} = 16V |
| Q _{rr} | Reverse Recovery Charge | — | 185 | 275 | nC | di/dt = 100A/μs ④ |

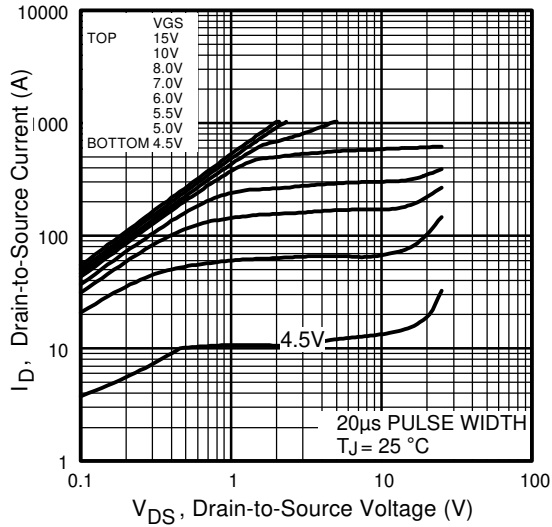

Fig 1. Typical Output Characteristics

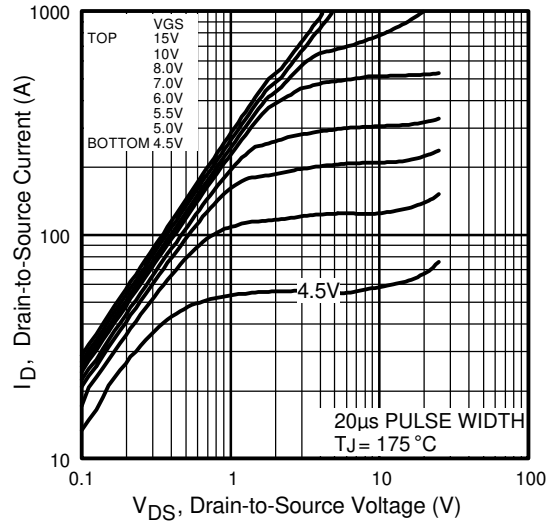

Fig 2. Typical Output Characteristics

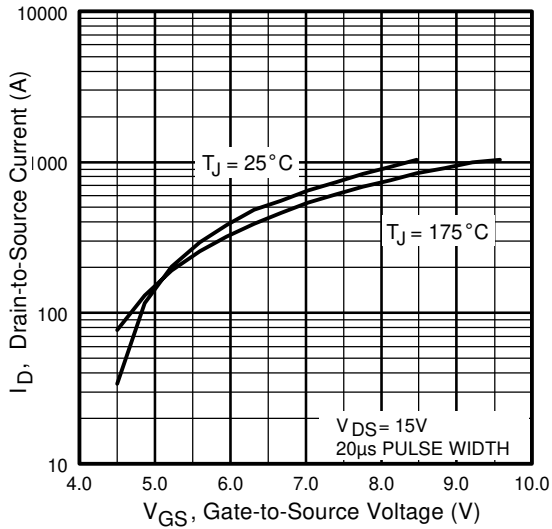

Fig 3. Typical Transfer Characteristics

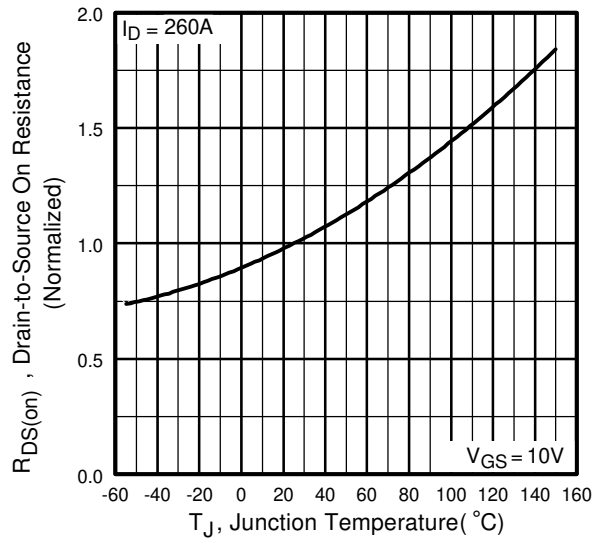

Fig 4. Normalized On-Resistance Vs. Temperature

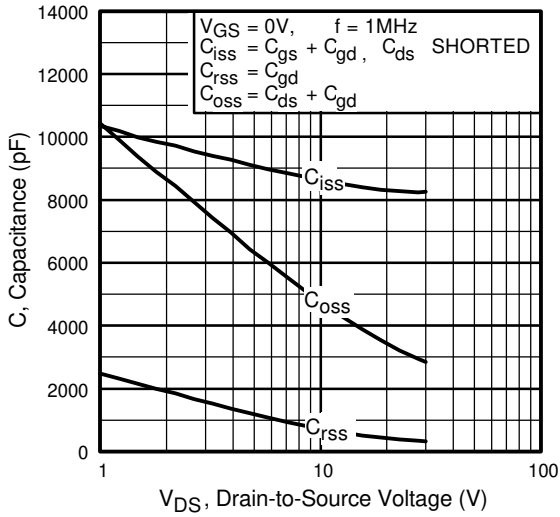

Fig 5. Typical Capacitance Vs. Drain-to-Source Voltage

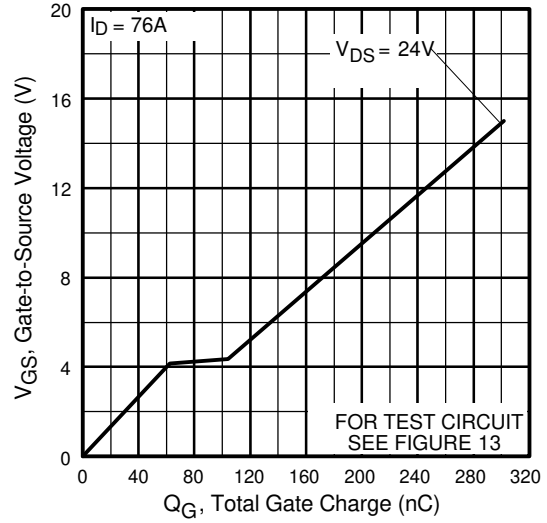

Fig 6. Typical Gate Charge Vs. Gate-to-Source Voltage

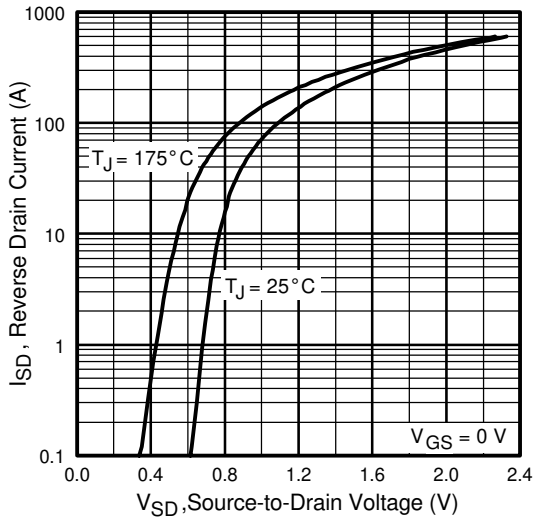

Fig 7. Typical Source-Drain Diode Forward Voltage

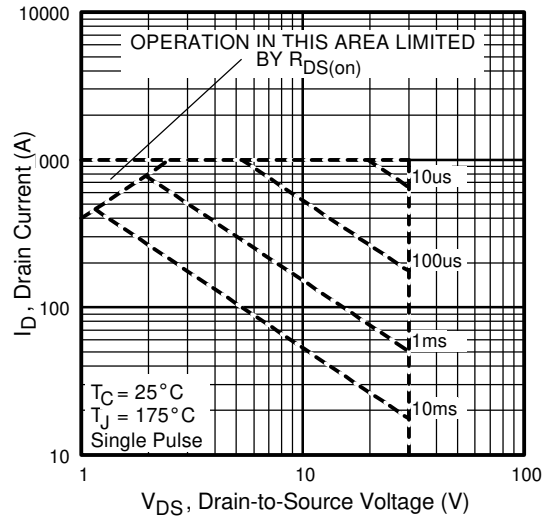

Fig 8. Maximum Safe Operating Area

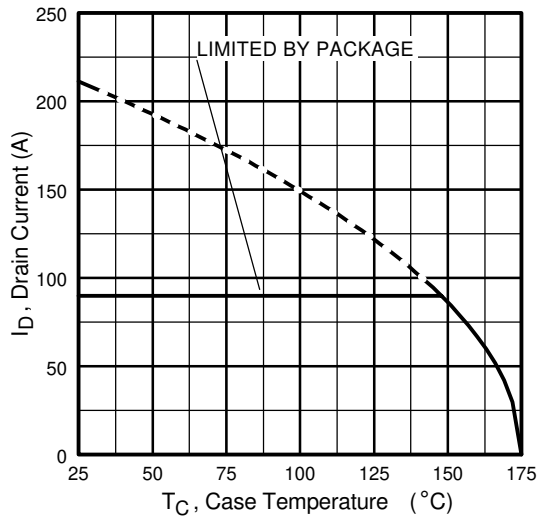

Fig 9. Maximum Drain Current Vs. Case Temperature

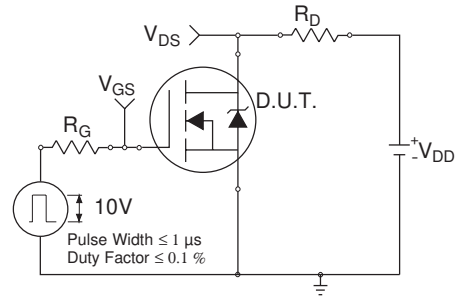

Fig 10a. Switching Time Test Circuit

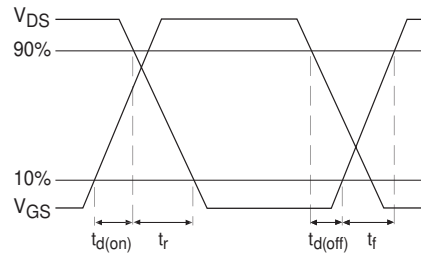

Fig 10b. Switching Time Waveforms

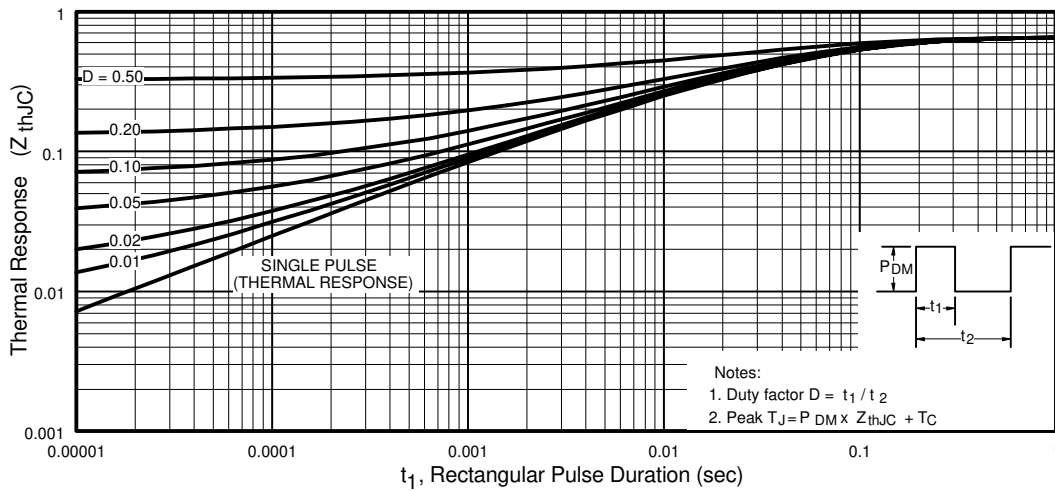

Fig 11. Maximum Effective Transient Thermal Impedance, Junction-to-Case

IRFP3703

International
IR Rectifier

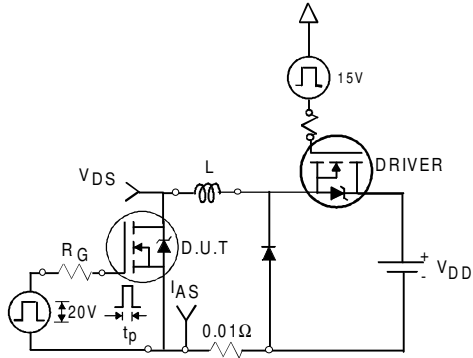

Fig 12a. Unclamped Inductive Test Circuit

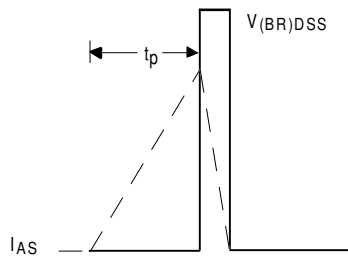

Fig 12b. Unclamped Inductive Waveforms

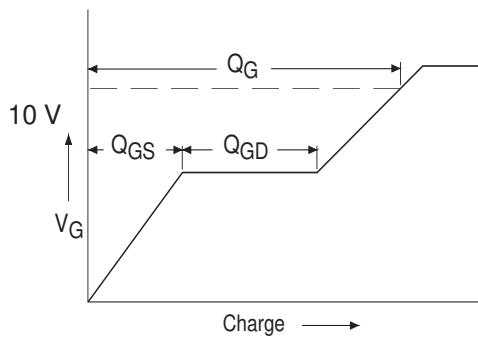

Fig 13a. Basic Gate Charge Waveform

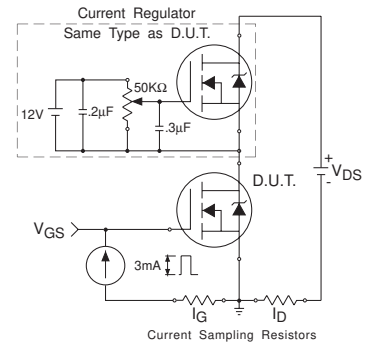

Fig 13b. Gate Charge Test Circuit

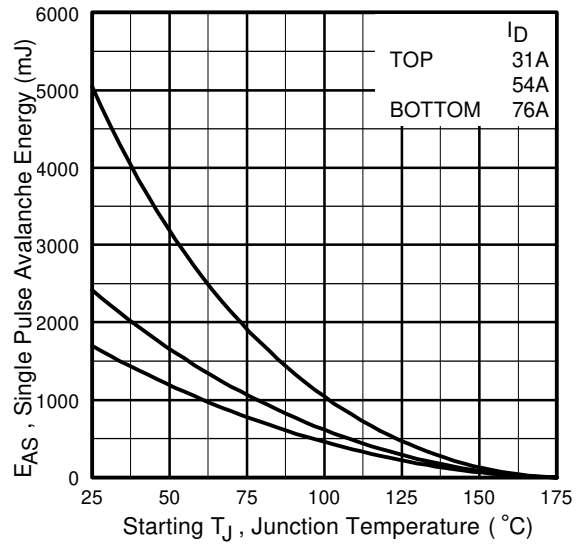
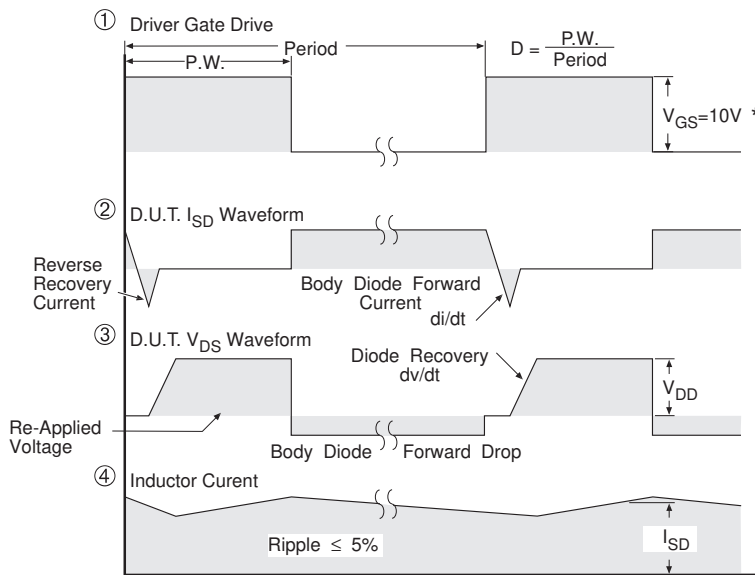
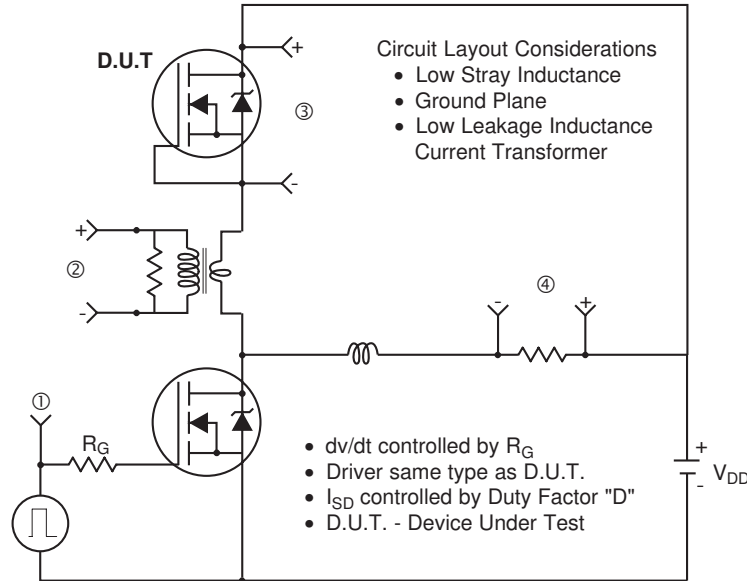

Fig 12c. Maximum Avalanche Energy Vs. Drain Current

Peak Diode Recovery dv/dt Test Circuit



* $V_{GS} = 5V$ for Logic Level Devices

Fig 14. For N-Channel HEXFET® Power MOSFET

IRFP3703

International
IR Rectifier

TO - 247 Package Outline

Dimensions are shown in millimeters (inches)

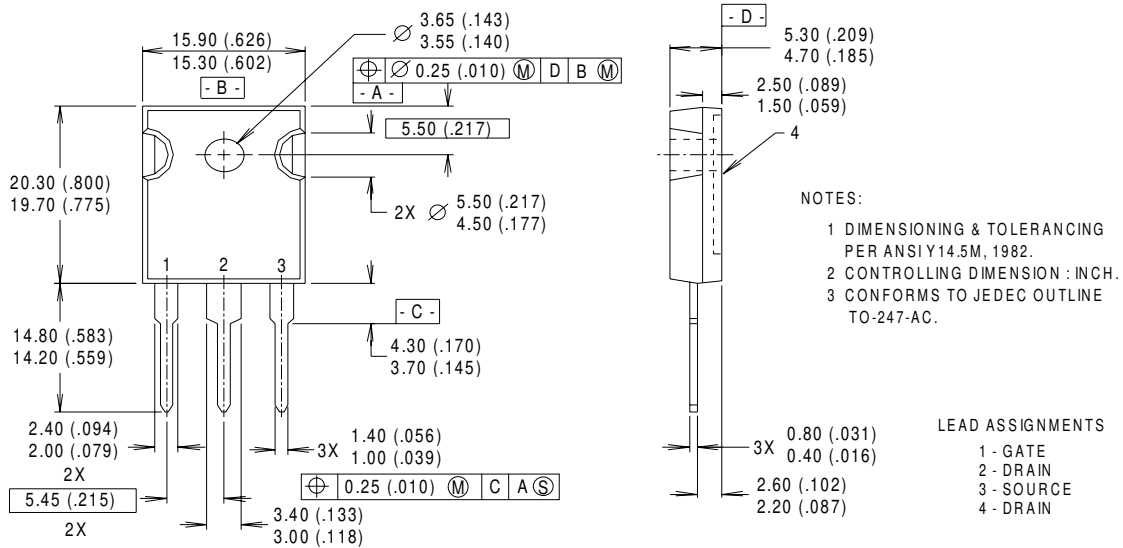

Notes:

- ① Repetitive rating; pulse width limited by max. junction temperature.
- ② Starting $T_J = 25^\circ\text{C}$, $L = 0.6\text{mH}$
 $R_G = 25\Omega$, $I_{AS} = 76\text{A}$.
- ③ $I_{SD} \leq 76\text{A}$, $di/dt \leq 100\text{A}/\mu\text{s}$, $V_{DD} \leq V_{(BR)DSS}$,
 $T_J \leq 175^\circ\text{C}$
- ④ Pulse width $\leq 300\mu\text{s}$; duty cycle $\leq 2\%$.
- ⑤ C_{OSS} eff. is a fixed capacitance that gives the same charging time as C_{OSS} while V_{DS} is rising from 0 to 80% V_{DSS}
- ⑥ Calculated continuous current based on maximum allowable junction temperature. Package limitation current is 90A

Data and specifications subject to change without notice.
This product has been designed and qualified for the Industrial market.
Qualification Standards can be found on IR's Web site.

International
IR Rectifier

IR WORLD HEADQUARTERS: 233 Kansas St., El Segundo, California 90245, USA Tel: (310) 252-7105
TAC Fax: (310) 252-7903

Visit us at www.irf.com for sales contact information.5/01

Note: For the most current drawings please refer to the IR website at:
<http://www.irf.com/package/>