



Chipsmall Limited consists of a professional team with an average of over 10 year of expertise in the distribution of electronic components. Based in Hongkong, we have already established firm and mutual-benefit business relationships with customers from,Europe,America and south Asia,supplying obsolete and hard-to-find components to meet their specific needs.

With the principle of “Quality Parts,Customers Priority,Honest Operation,and Considerate Service”,our business mainly focus on the distribution of electronic components. Line cards we deal with include Microchip,ALPS,ROHM,Xilinx,Pulse,ON,Everlight and Freescale. Main products comprise IC,Modules,Potentiometer,IC Socket,Relay,Connector.Our parts cover such applications as commercial,industrial, and automotives areas.

We are looking forward to setting up business relationship with you and hope to provide you with the best service and solution. Let us make a better world for our industry!



## Contact us

Tel: +86-755-8981 8866 Fax: +86-755-8427 6832

Email & Skype: info@chipsmall.com Web: www.chipsmall.com

Address: A1208, Overseas Decoration Building, #122 Zhenhua RD., Futian, Shenzhen, China



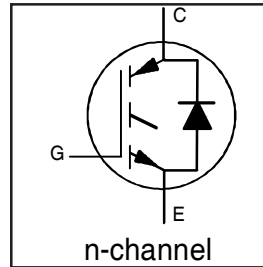
# IRG4IBC20FDPbF

INSULATED GATE BIPOLAR TRANSISTOR WITH  
ULTRAFAST SOFT RECOVERY DIODE

Fast CoPack IGBT

## Features

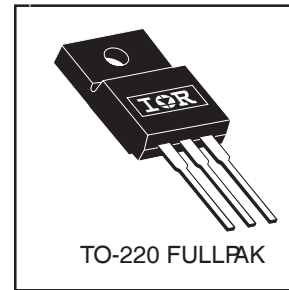
- Very Low 1.66V voltage drop
- 2.5kV, 60s insulation voltage Ⓢ
- 4.8 mm creepage distance to heatsink
- Fast: Optimized for medium operating frequencies ( 1-5 kHz in hard switching, >20 kHz in resonant mode).
- IGBT co-packaged with HEXFRED™ ultrafast, ultrasoft recovery antiparallel diodes
- Tighter parameter distribution
- Industry standard Isolated TO-220 Fullpak™ outline
- Lead-Free



$V_{CES} = 600V$
$V_{CE(on) typ.} = 1.66V$
@ $V_{GE} = 15V, I_C = 9.0A$

## Benefits

- Simplified assembly
- Highest efficiency and power density
- HEXFRED™ antiparallel Diode minimizes switching losses and EMI



## Absolute Maximum Ratings

	Parameter	Max.	Units
$V_{CES}$	Collector-to-Emitter Voltage	600	V
$I_C @ T_C = 25^\circ C$	Continuous Collector Current	14.3	A
$I_C @ T_C = 100^\circ C$	Continuous Collector Current	7.7	
$I_{CM}$	Pulsed Collector Current ①	64	
$I_{LM}$	Clamped Inductive Load Current ②	64	
$I_F @ T_C = 100^\circ C$	Diode Continuous Forward Current	6.5	
$I_{FM}$	Diode Maximum Forward Current	64	
Visol	RMS Isolation Voltage, Terminal to CaseⓈ	2500	V
$V_{GE}$	Gate-to-Emitter Voltage	$\pm 20$	
$P_D @ T_C = 25^\circ C$	Maximum Power Dissipation	34	W
$P_D @ T_C = 100^\circ C$	Maximum Power Dissipation	14	
$T_J$	Operating Junction and	-55 to +150	°C
$T_{STG}$	Storage Temperature Range		
	Soldering Temperature, for 10 sec.	300 (0.063 in. (1.6mm) from case)	
	Mounting Torque, 6-32 or M3 Screw.	10 lbf•in (1.1 N•m)	

## Thermal Resistance

	Parameter	Typ.	Max.	Units
$R_{\theta JC}$	Junction-to-Case - IGBT	—	3.7	°C/W
$R_{\theta JC}$	Junction-to-Case - Diode	—	5.1	
$R_{\theta JA}$	Junction-to-Ambient, typical socket mount	—	65	
Wt	Weight	2.0 (0.07)	—	g (oz)

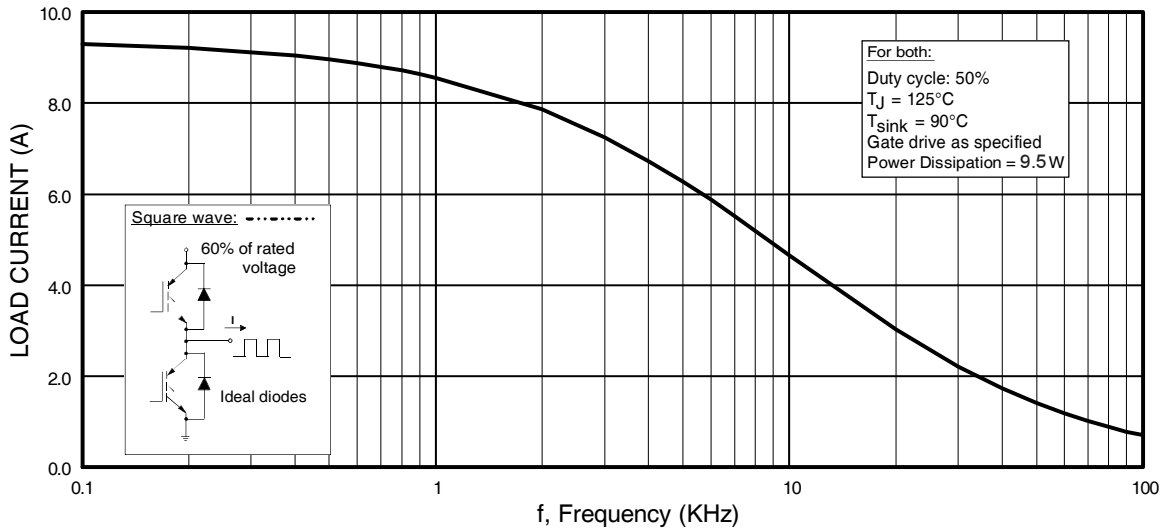
# IRG4IBC20FDPbF

## Electrical Characteristics @ T<sub>J</sub> = 25°C (unless otherwise specified)

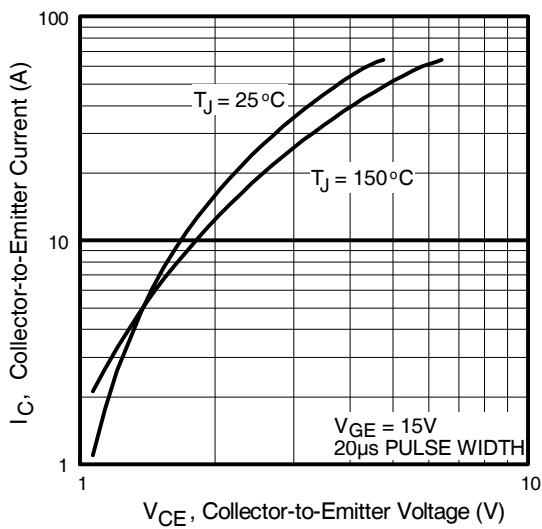
	Parameter	Min.	Typ.	Max.	Units	Conditions
V <sub>(BR)CES</sub>	Collector-to-Emitter Breakdown Voltage <sup>③</sup>	600	—	—	V	V <sub>GE</sub> = 0V, I <sub>C</sub> = 250μA
ΔV <sub>(BR)CES/ΔT<sub>J</sub></sub>	Temperature Coeff. of Breakdown Voltage	—	0.72	—	V/°C	V <sub>GE</sub> = 0V, I <sub>C</sub> = 1.0mA
V <sub>CE(on)</sub>	Collector-to-Emitter Saturation Voltage	—	1.66	2.0	V	I <sub>C</sub> = 9.0A
		—	2.06	—		I <sub>C</sub> = 16A
		—	1.76	—		I <sub>C</sub> = 9.0A, T <sub>J</sub> = 150°C
V <sub>GE(th)</sub>	Gate Threshold Voltage	3.0	—	6.0		V <sub>CE</sub> = V <sub>GE</sub> , I <sub>C</sub> = 250μA
ΔV <sub>GE(th)/ΔT<sub>J</sub></sub>	Temperature Coeff. of Threshold Voltage	—	-11	—	mV/°C	V <sub>CE</sub> = V <sub>GE</sub> , I <sub>C</sub> = 250μA
g <sub>fe</sub>	Forward Transconductance <sup>④</sup>	2.9	5.1	—	S	V <sub>CE</sub> = 100V, I <sub>C</sub> = 9.0A
I <sub>CES</sub>	Zero Gate Voltage Collector Current	—	—	250	μA	V <sub>GE</sub> = 0V, V <sub>CE</sub> = 600V
		—	—	1700		V <sub>GE</sub> = 0V, V <sub>CE</sub> = 600V, T <sub>J</sub> = 150°C
V <sub>FM</sub>	Diode Forward Voltage Drop	—	1.4	1.7	V	I <sub>C</sub> = 8.0A
		—	1.3	1.6		I <sub>C</sub> = 8.0A, T <sub>J</sub> = 150°C
I <sub>GES</sub>	Gate-to-Emitter Leakage Current	—	—	±100	nA	V <sub>GE</sub> = ±20V

## Switching Characteristics @ T<sub>J</sub> = 25°C (unless otherwise specified)

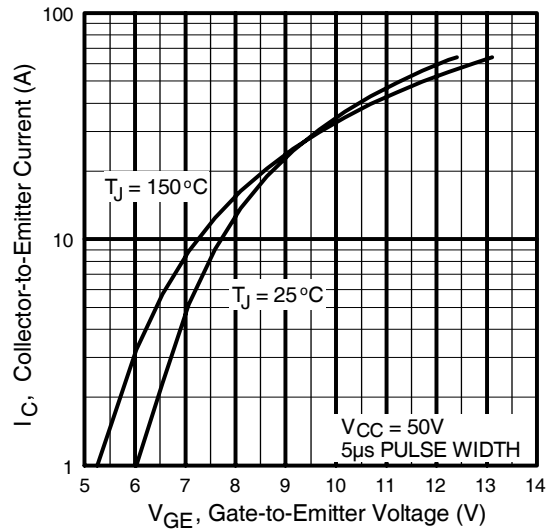
	Parameter	Min.	Typ.	Max.	Units	Conditions
Q <sub>g</sub>	Total Gate Charge (turn-on)	—	27	40	nC	I <sub>C</sub> = 9.0A
Q <sub>ge</sub>	Gate - Emitter Charge (turn-on)	—	4.2	6.2		V <sub>CC</sub> = 400V
Q <sub>gc</sub>	Gate - Collector Charge (turn-on)	—	9.9	15		V <sub>GE</sub> = 15V
t <sub>d(on)</sub>	Turn-On Delay Time	—	43	—	ns	T <sub>J</sub> = 25°C
t <sub>r</sub>	Rise Time	—	20	—		I <sub>C</sub> = 9.0A, V <sub>CC</sub> = 480V
t <sub>d(off)</sub>	Turn-Off Delay Time	—	240	360		V <sub>GE</sub> = 15V, R <sub>G</sub> = 50Ω
t <sub>f</sub>	Fall Time	—	150	220		Energy losses include "tail" and diode reverse recovery.
E <sub>on</sub>	Turn-On Switching Loss	—	0.25	—	mJ	See Fig. 9, 10, 18
E <sub>off</sub>	Turn-Off Switching Loss	—	0.64	—		
E <sub>ts</sub>	Total Switching Loss	—	0.89	1.3		
t <sub>d(on)</sub>	Turn-On Delay Time	—	41	—	ns	T <sub>J</sub> = 150°C, See Fig. 11, 18
t <sub>r</sub>	Rise Time	—	22	—		I <sub>C</sub> = 9.0A, V <sub>CC</sub> = 480V
t <sub>d(off)</sub>	Turn-Off Delay Time	—	320	—		V <sub>GE</sub> = 15V, R <sub>G</sub> = 50Ω
t <sub>f</sub>	Fall Time	—	290	—		Energy losses include "tail" and diode reverse recovery.
E <sub>ts</sub>	Total Switching Loss	—	1.35	—	mJ	
L <sub>E</sub>	Internal Emitter Inductance	—	7.5	—	nH	Measured 5mm from package
C <sub>ies</sub>	Input Capacitance	—	540	—	pF	V <sub>GE</sub> = 0V
C <sub>oes</sub>	Output Capacitance	—	37	—		V <sub>CC</sub> = 30V
C <sub>res</sub>	Reverse Transfer Capacitance	—	7.0	—		f = 1.0MHz
t <sub>rr</sub>	Diode Reverse Recovery Time	—	37	55	ns	T <sub>J</sub> = 25°C See Fig. 14
		—	55	90		T <sub>J</sub> = 125°C
I <sub>rr</sub>	Diode Peak Reverse Recovery Current	—	3.5	5.0	A	T <sub>J</sub> = 25°C See Fig. 15
		—	4.5	8.0		T <sub>J</sub> = 125°C
Q <sub>rr</sub>	Diode Reverse Recovery Charge	—	65	138	nC	T <sub>J</sub> = 25°C See Fig. 16
		—	124	360		T <sub>J</sub> = 125°C
di <sub>(rec)M/dt</sub>	Diode Peak Rate of Fall of Recovery During t <sub>b</sub>	—	240	—	A/μs	T <sub>J</sub> = 25°C See Fig. 17
		—	210	—		T <sub>J</sub> = 125°C



**Fig. 1 - Typical Load Current vs. Frequency**  
(Load Current =  $I_{\text{RMS}}$  of fundamental)



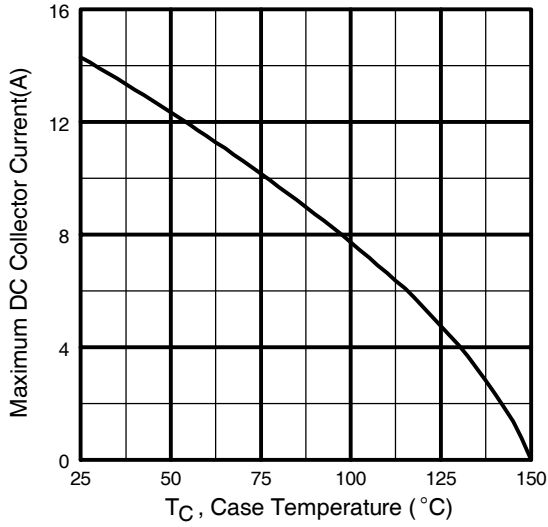
**Fig. 2 - Typical Output Characteristics**  
www.irf.com



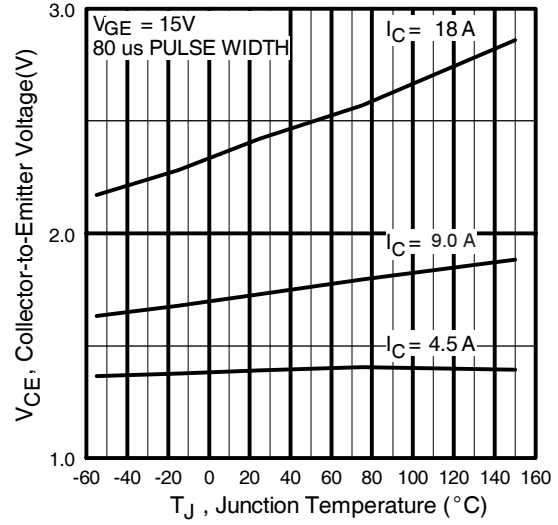
**Fig. 3 - Typical Transfer Characteristics**

# IRG4IBC20FDPbF

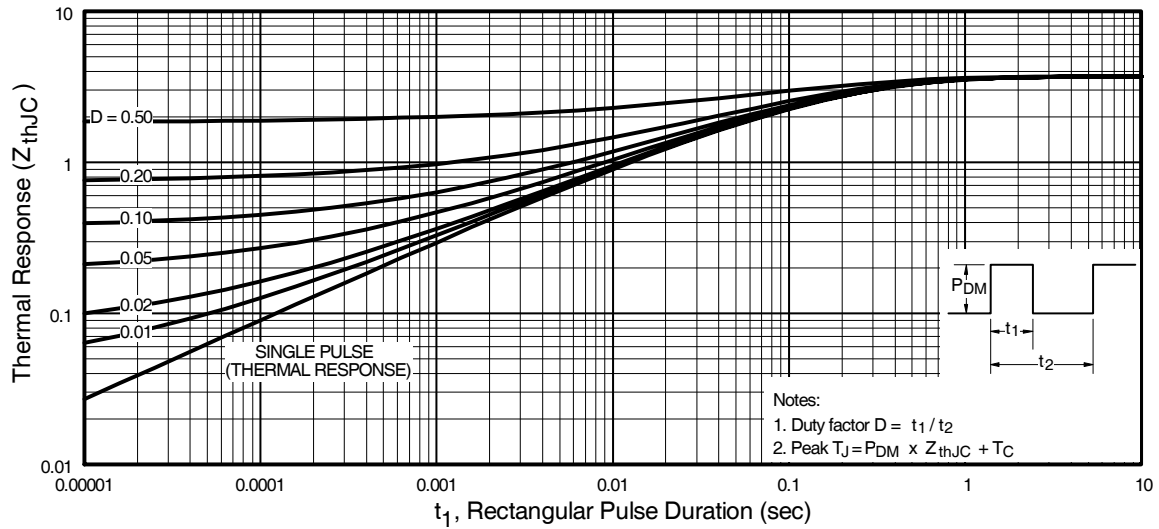
International  
**IRF** Rectifier



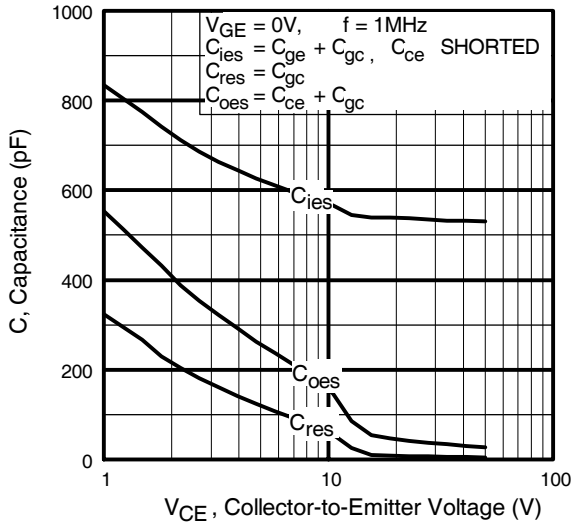
**Fig. 4** - Maximum Collector Current vs. Case Temperature



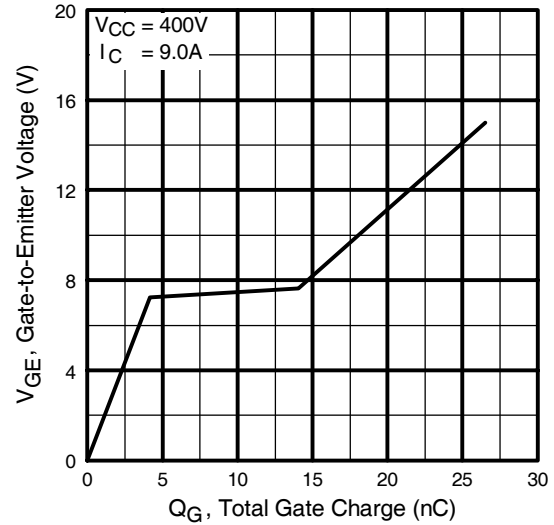
**Fig. 5** - Typical Collector-to-Emitter Voltage vs. Junction Temperature



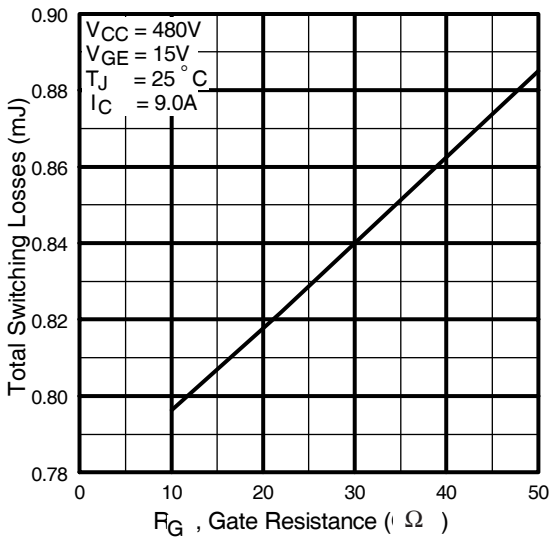
**Fig. 6** - Maximum Effective Transient Thermal Impedance, Junction-to-Case



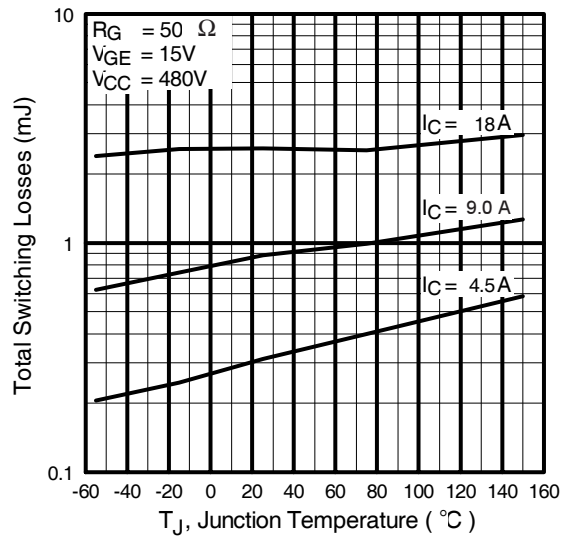
**Fig. 7** - Typical Capacitance vs. Collector-to-Emitter Voltage



**Fig. 8** - Typical Gate Charge vs. Gate-to-Emitter Voltage

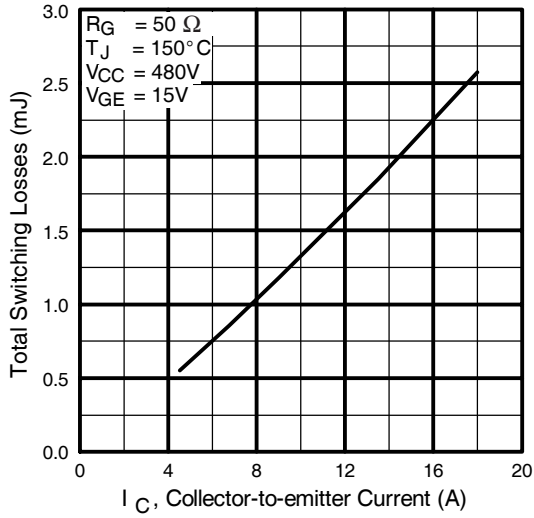


**Fig. 9** - Typical Switching Losses vs. Gate Resistance

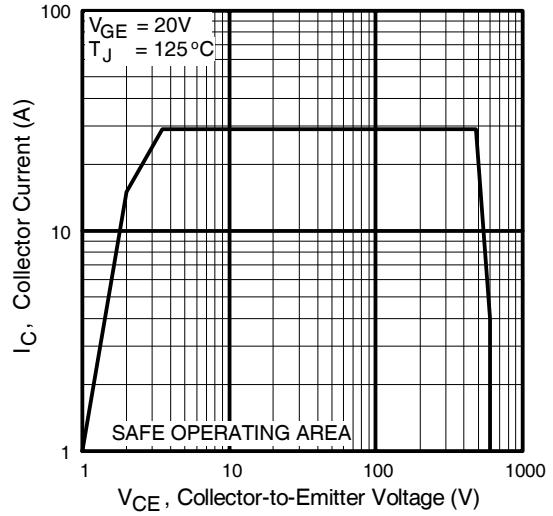


**Fig. 10** - Typical Switching Losses vs. Junction Temperature

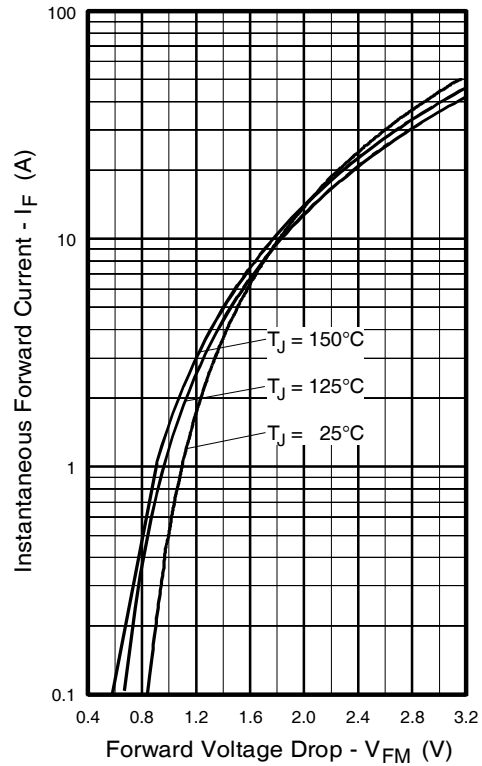
# IRG4IBC20FDPbF



**Fig. 11** - Typical Switching Losses vs. Collector-to-Emitter Current



**Fig. 12** - Turn-Off SOA



**Fig. 13** - Maximum Forward Voltage Drop vs. Instantaneous Forward Current

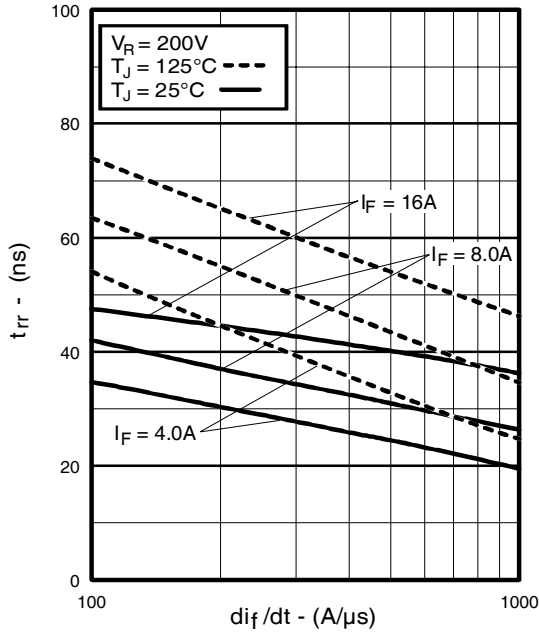


Fig. 14 - Typical Reverse Recovery vs.  $di_f/dt$

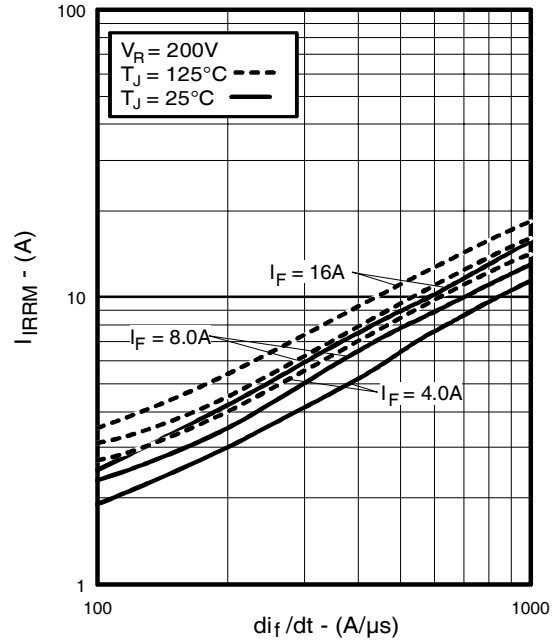


Fig. 15 - Typical Recovery Current vs.  $di_f/dt$

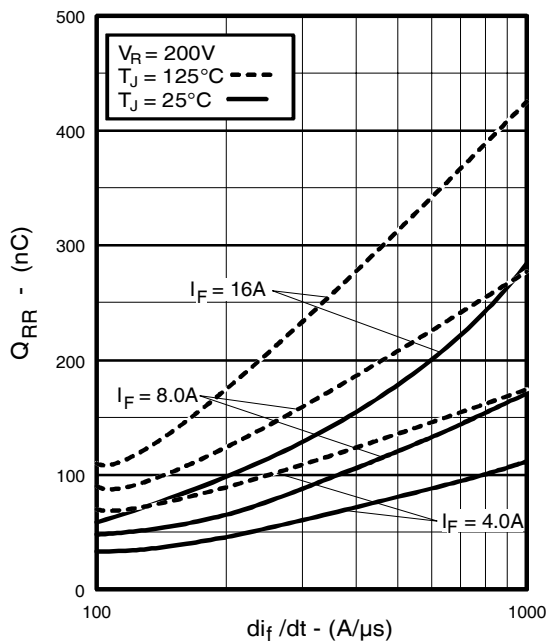


Fig. 16 - Typical Stored Charge vs.  $di_f/dt$   
www.irf.com

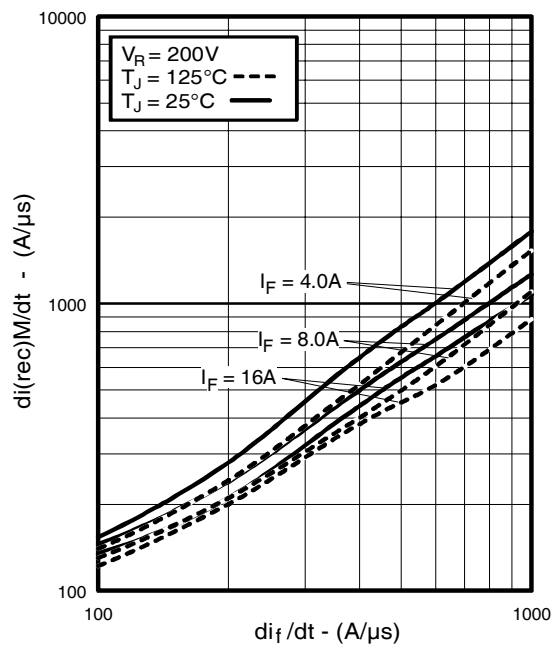
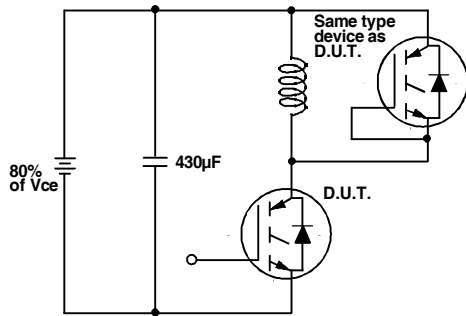


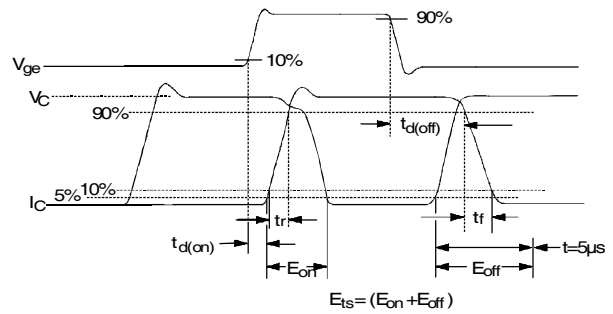
Fig. 17 - Typical  $di_{(rec)M}/dt$  vs.  $di_f/dt$



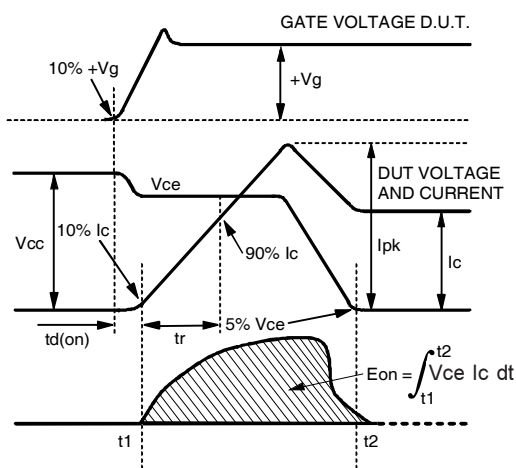
# IRG4IBC20FDPbF



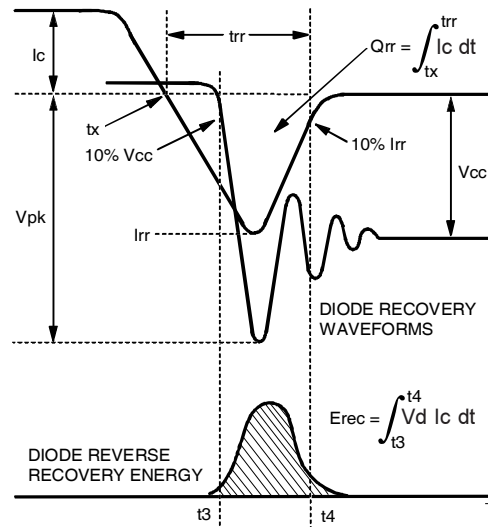
**Fig. 18a** - Test Circuit for Measurement of  $I_{LM}$ ,  $E_{on}$ ,  $E_{off}(\text{diode})$ ,  $t_{rr}$ ,  $Q_{rr}$ ,  $I_{rr}$ ,  $t_{d(on)}$ ,  $t_r$ ,  $t_{d(off)}$ ,  $t_f$



**Fig. 18b** - Test Waveforms for Circuit of Fig. 18a, Defining  $E_{off}$ ,  $t_{d(off)}$ ,  $t_f$



**Fig. 18c** - Test Waveforms for Circuit of Fig. 18a, Defining  $E_{on}$ ,  $t_{d(on)}$ ,  $t_r$



**Fig. 18d** - Test Waveforms for Circuit of Fig. 18a, Defining  $E_{rec}$ ,  $t_{rr}$ ,  $Q_{rr}$ ,  $I_{rr}$

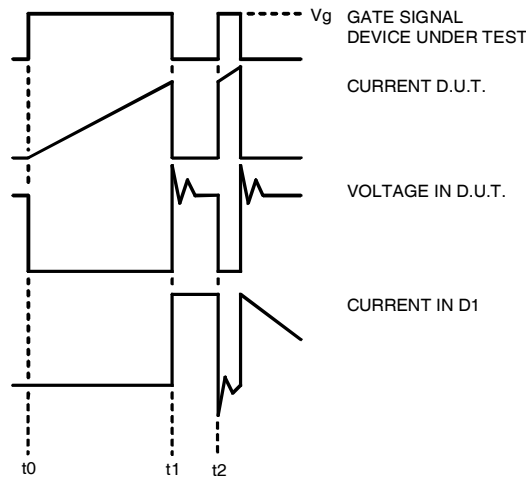


Figure 18e. Macro Waveforms for Figure 18a's Test Circuit

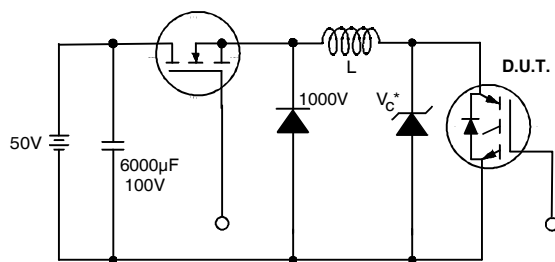


Figure 19. Clamped Inductive Load Test Circuit

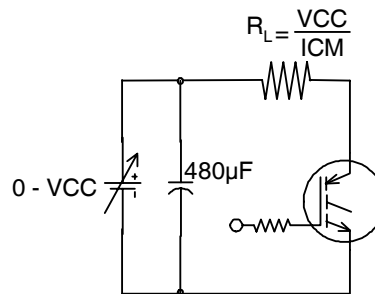


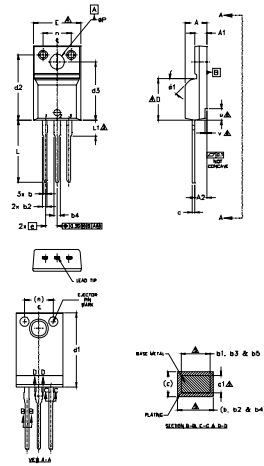
Figure 20. Pulsed Collector Current Test Circuit

# IRG4IBC20FDPbF

International  
**IR** Rectifier

## TO-220AB Full-Pak Package Outline

Dimensions are shown in millimeters (inches)



SYMBOL	DIMENSIONS				NOTES
	MILLIMETERS		INCHES		
	MIN.	MAX.	MIN.	MAX.	
A	4.57	4.83	.180	.190	
A1	2.57	2.83	.101	.111	
A2	2.51	2.93	.099	.115	
b	0.81	0.94	.024	.037	
b1	0.81	0.89	.024	.035	
b2	0.76	1.27	.030	.050	
b3	0.76	1.22	.030	.048	
b4	1.02	1.52	.040	.060	
b5	1.02	1.47	.040	.058	
c	0.33	0.63	.013	.025	
c1	0.33	0.58	.013	.023	
D	8.66	9.80	.341	.386	
d1	15.80	16.15	.622	.635	
d2	13.97	14.22	.550	.560	
d3	12.30	12.93	.484	.509	
E	9.63	10.75	.379	.423	
e	2.54 SSC		.100 SSC		
L	13.20	13.72	.520	.540	
L1	3.37	3.67	.122	.145	
n	6.05	6.60	.238	.260	
ØP	3.05	3.45	.120	.136	
u	2.40	2.50	.094	.098	
y	0.40	0.50	.016	.020	
Ø1	-	45°	-	45°	

NOTES  
 1.0 DIMENSIONING AND TOLERANCING AS PER ASME Y14.5 M-1994.  
 2.0 DIMENSIONS ARE SHOWN IN MILLIMETERS (INCHES).  
 3.0 LEAD DIMENSION AND PITCH SHOULD BE FOLLOWS IN 1.1.  
 4.0 DIMENSION D & E DO NOT INCLUDE MOLDED FLASH. MOLDED FLASH SHALL NOT EXCEED .007" (0.175) PER SIDE. THESE DIMENSIONS ARE MEASURED AT THE OUTER MOST EXTREMITY OF THE PLASTIC BODY.  
 5.0 DIMENSION D1, D2, D3 & E1 APPLY TO BASE METAL ONLY.  
 6.0 STEP OPTIONAL ON PLASTIC BODY DEFINED BY DIMENSIONS a & b.  
 7.0 CONTROLLING DIMENSION - NOTES.

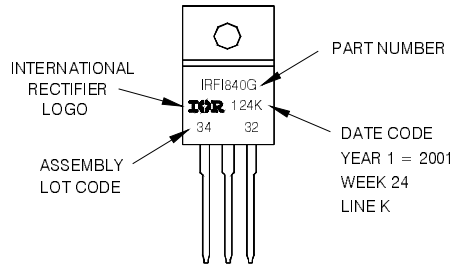
LEAD ASSIGNMENTS  
 1 - GATE  
 2 - DIODE  
 3 - SOURCE

MATERIALS  
 1 - GATE  
 2 - DIODE  
 3 - EMITTER

## TO-220AB Full-Pak Part Marking Information

EXAMPLE: THIS IS AN IRFI840G  
 WITH ASSEMBLY  
 LOT CODE 3432  
 ASSEMBLED ON WW 24, 2001  
 IN THE ASSEMBLY LINE 'K'

Note: 'P' in assembly line position indicates 'Lead-Free'



TO-220AB Full-Pak package is not recommended for Surface Mount Application.

### Notes:

- ① Repetitive rating:  $V_{GE}=20V$ ; pulse width limited by maximum junction temperature (figure 20)
- ②  $V_{CC}=80\%(V_{CES})$ ,  $V_{GE}=20V$ ,  $L=10\mu H$ ,  $R_G = 50\Omega$  (figure 19)
- ③ Pulse width  $\leq 80\mu s$ ; duty factor  $\leq 0.1\%$ .
- ④ Pulse width  $5.0\mu s$ , single shot.
- ⑤  $t = 60s$ ,  $f = 60Hz$

Note: For the most current drawing please refer to IR website at <http://www.irf.com/package/>

Data and specifications subject to change without notice.

International  
**IR** Rectifier

IR WORLD HEADQUARTERS: 233 Kansas St., El Segundo, California 90245, USA Tel: (310) 252-7105  
 TAC Fax: (310) 252-7903

Visit us at [www.irf.com](http://www.irf.com) for sales contact information.01/2010  
[www.irf.com](http://www.irf.com)