



Chipsmall Limited consists of a professional team with an average of over 10 year of expertise in the distribution of electronic components. Based in Hongkong, we have already established firm and mutual-benefit business relationships with customers from,Europe,America and south Asia,supplying obsolete and hard-to-find components to meet their specific needs.

With the principle of “Quality Parts,Customers Priority,Honest Operation,and Considerate Service”,our business mainly focus on the distribution of electronic components. Line cards we deal with include Microchip,ALPS,ROHM,Xilinx,Pulse,ON,Everlight and Freescale. Main products comprise IC,Modules,Potentiometer,IC Socket,Relay,Connector.Our parts cover such applications as commercial,industrial, and automotives areas.

We are looking forward to setting up business relationship with you and hope to provide you with the best service and solution. Let us make a better world for our industry!



Contact us

Tel: +86-755-8981 8866 Fax: +86-755-8427 6832

Email & Skype: info@chipsmall.com Web: www.chipsmall.com

Address: A1208, Overseas Decoration Building, #122 Zhenhua RD., Futian, Shenzhen, China



$V_{CES} = 1200V$
$I_C = 75A$ at $T_C = 80^\circ C$
$t_{SC} \geq 10\mu sec$
$V_{CE(ON)} = 1.90V$ at $I_C = 75A$

**IGBT Half-Bridge
POWIR 34™ Package**



Applications:

- Industrial Motor Drive
- Uninterruptible Power Supply
- Welding and Cutting Machine
- Switched Mode Power Supply
- Induction Heating
- AC Inverter Drive

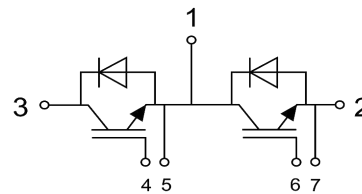

Features	Benefits
Low $V_{CE(ON)}$ and Switching Losses	High Efficiency in a Wide Range of Applications
100% RBSOA Tested	Rugged Transient Performance
10μsec Short Circuit Safe Operating Area	
POWIR 34™ Package	Industry Standard
Lead Free	RoHS Compliant, Environmental Friendly

Base Part Number	Package Type	Standard Pack	Quantity	Orderable Part Number
IRG7T75HF12A	POWIR 34™	Box	80	IRG7T75HF12A

Absolute Maximum Ratings of IGBT

V_{CES}	Collector to Emitter Voltage	1200	V
V_{GES}	Continuous Gate to Emitter Voltage	±20	V
I_C	Continuous Collector Current	$T_C = 80^\circ C$	75 A
		$T_C = 25^\circ C$	150 A
I_{CM}	Pulse Collector Current	$T_J = 175^\circ C$	150 A
P_D	Maximum Power Dissipation (IGBT)	$T_C = 25^\circ C, T_J = 175^\circ C$	450 W
T_J	Maximum IGBT Junction Temperature	175	°C
T_{JOP}	Maximum Operating Junction Temperature Range	-40 to +150	°C
T_{stg}	Storage Temperature	-40 to +125	°C

Electrical Characteristics of IGBT at $T_J = 25^\circ\text{C}$ (Unless Otherwise Specified)

Parameter		Min.	Typ.	Max.	Unit	Test Conditions	
$V_{(BR)CES}$	Collector to Emitter Breakdown Voltage	1200			V	$V_{GE} = 0V, I_C = 1mA$	
$V_{GE(th)}$	Gate Threshold Voltage	5.0	5.8	6.5	V	$I_C = 3.5mA, V_{CE} = V_{GE}$	
$V_{CE(ON)}$	Collector to Emitter Saturation Voltage		1.90	2.20	V	$T_J = 25^\circ\text{C}$	$I_C = 75A, V_{GE} = 15V$
			2.20		V	$T_J = 125^\circ\text{C}$	
I_{CES}	Collector to Emitter Leakage Current			1	mA	$V_{GE} = 0V, V_{CE} = V_{CES}$	
I_{GES}	Gate to Emitter Leakage Current			400	nA	$V_{GE} = \pm 20V, V_{CE} = 0V$	
R_{Gint}	Internal Gate Resistance		2.5		Ω		

Switching Characteristics of IGBT

Parameter		Min.	Typ.	Max.	Unit	Test Conditions	
$t_{d(on)}$	Turn-on Delay Time		190		ns	$T_J = 25^\circ\text{C}$	$V_{CC} = 600V, I_C = 75A, R_G = 15\Omega, V_{GE} = \pm 15V, \text{Inductive Load}$
			175			$T_J = 125^\circ\text{C}$	
t_r	Rise Time		100		ns	$T_J = 25^\circ\text{C}$	
			110			$T_J = 125^\circ\text{C}$	
$t_{d(off)}$	Turn-off Delay Time		270		ns	$T_J = 25^\circ\text{C}$	
			280			$T_J = 125^\circ\text{C}$	
t_f	Fall Time		160		ns	$T_J = 25^\circ\text{C}$	
			240			$T_J = 125^\circ\text{C}$	
E_{on}	Turn-on Switching Loss		5.2		mJ	$T_J = 25^\circ\text{C}$	
			6.9			$T_J = 125^\circ\text{C}$	
E_{off}	Turn-off Switching Loss		3.6		mJ	$T_J = 25^\circ\text{C}$	
			5.5			$T_J = 125^\circ\text{C}$	
Q_g	Total Gate Charge		630		nC	$T_J = 25^\circ\text{C}$	
C_{ies}	Input Capacitance		10.4		nF	$V_{CE} = 25V, V_{GE} = 0V, f = 1MHz, T_J = 25^\circ\text{C}$	
C_{oes}	Output Capacitance		0.56				
C_{res}	Reverse Transfer Capacitance		0.37				
RBSOA	Reverse Bias Safe Operating Area	Trapezoid				$I_C = 150A, V_{CC} = 960V, V_P = 1200V, R_G = 15\Omega, V_{GE} = +15V \text{ to } 0V, T_J = 150^\circ\text{C}$	
SCSOA	Short Circuit Safe Operating Area	10			μs	$V_{CC} = 600V, V_{GE} = 15V, T_J = 150^\circ\text{C}$	

Absolute Maximum Ratings of Freewheeling Diode

V_{RRM}	Repetitive Peak Reverse Voltage	1200	V
I_F	Diode Continuous Forward Current, $T_C = 25^\circ\text{C}$	150	A
	Diode Continuous Forward Current, $T_C = 80^\circ\text{C}$	75	
I_{FM}	Pulse Diode Current	150	A

Electrical and Switching Characteristics of Freewheeling Diode

Parameter		Typ.	Max.	Unit	Test Conditions	
V_F	Forward Voltage	2.20	2.70	V	$T_J = 25^\circ\text{C}$	$I_F = 75\text{A}$, $V_{GE} = 0\text{V}$
		2.40			$T_J = 125^\circ\text{C}$	
I_{rr}	Peak Reverse Recovery Current	30		A	$T_J = 25^\circ\text{C}$	
		45			$T_J = 125^\circ\text{C}$	
Q_{rr}	Reverse Recovery Charge	3.6		μC	$T_J = 25^\circ\text{C}$	
		7.4			$T_J = 125^\circ\text{C}$	
E_{rec}	Reverse Recovery Energy	1.5		mJ	$T_J = 25^\circ\text{C}$	
		3.3			$T_J = 125^\circ\text{C}$	

Module Characteristics

Parameter		Min.	Typ.	Max.	Unit
V_{iso}	Isolation Voltage (All Terminals Shorted), $f = 50\text{Hz}$, 1minute			2500	V
$R_{\theta JC}$	Junction-to-Case (IGBT)		0.33		$^\circ\text{C/W}$
$R_{\theta JC}$	Junction-to-Case (Diode)		0.56		$^\circ\text{C/W}$
$R_{\theta CS}$	Case-To-Sink (Conductive Grease Applied)		0.1		$^\circ\text{C/W}$
M	Power Terminals Screw: M5	3.0		5.0	N·m
M	Mounting Screw: M6	4.0		6.0	N·m
G	Weight		165		g

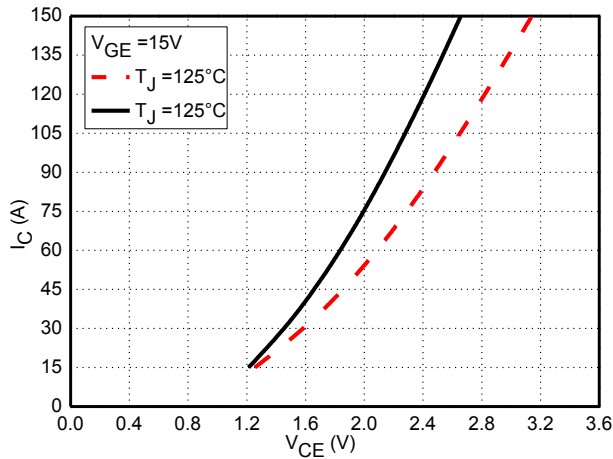

Fig.1 Typical IGBT Saturation Characteristics

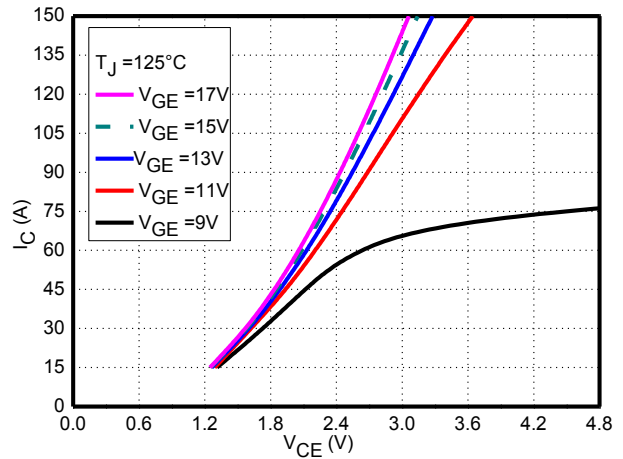

Fig.2 Typical IGBT Output Characteristics

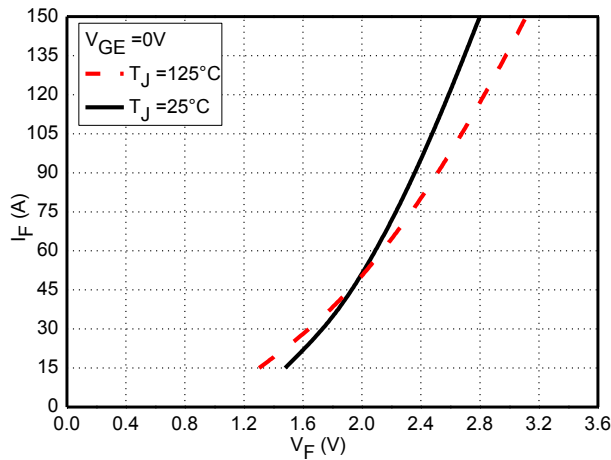

Fig.3 Typical Diode Forward Characteristics

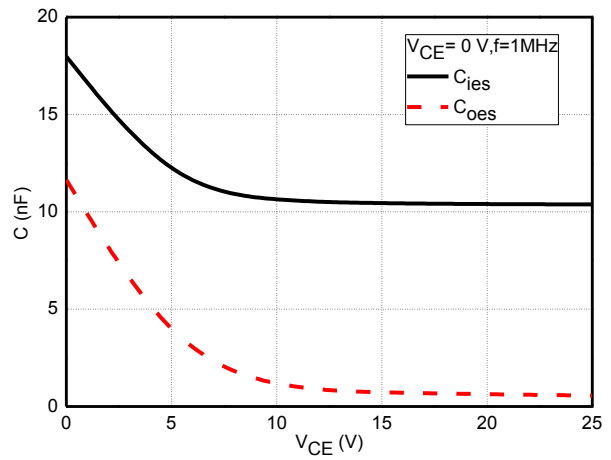

Fig. 4 Typical Capacitance Characteristics

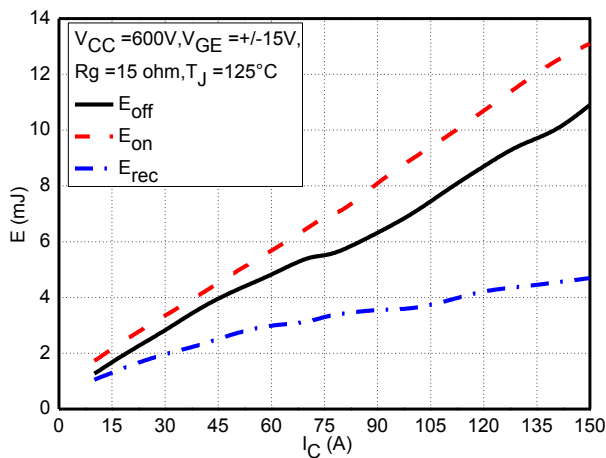

Fig.5 Typical Switching Loss vs. Collector Current

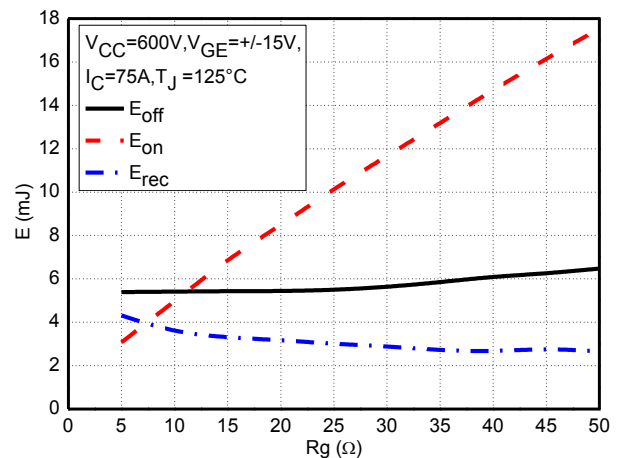

Fig.6 Typical Switching Loss vs. Gate Resistance

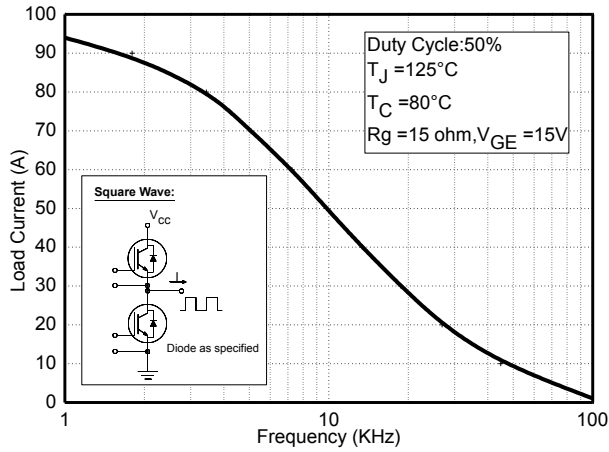

Fig.7 Typical Load Current vs. Frequency

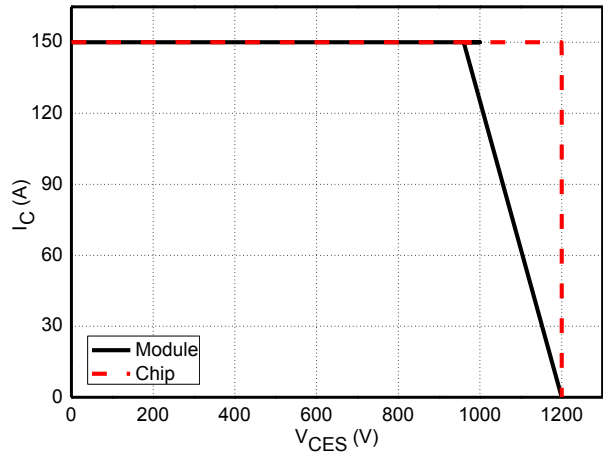

Fig.8 Reverse Bias Safe Operation Area (RBSOA)

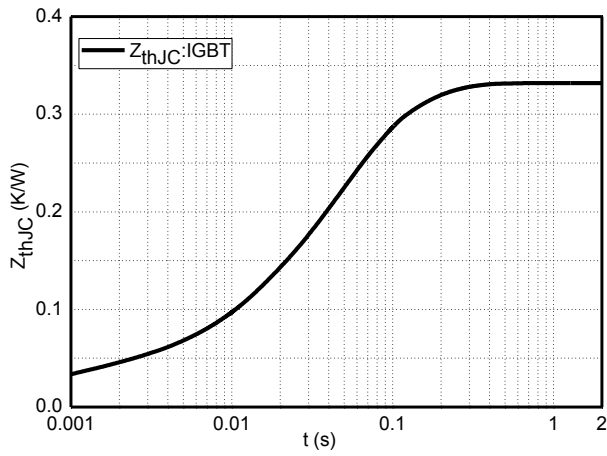

Fig.9 Typical Transient Thermal Impedance (IGBT)

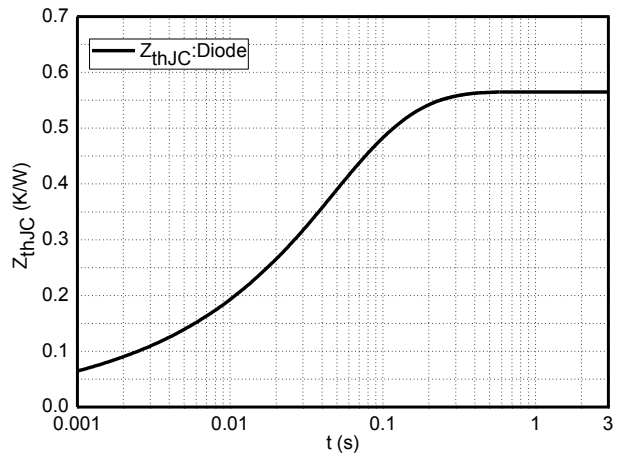
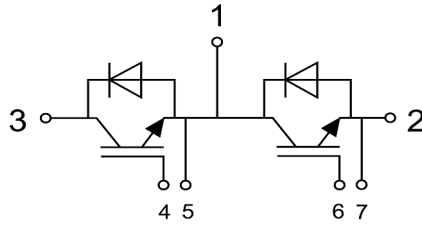
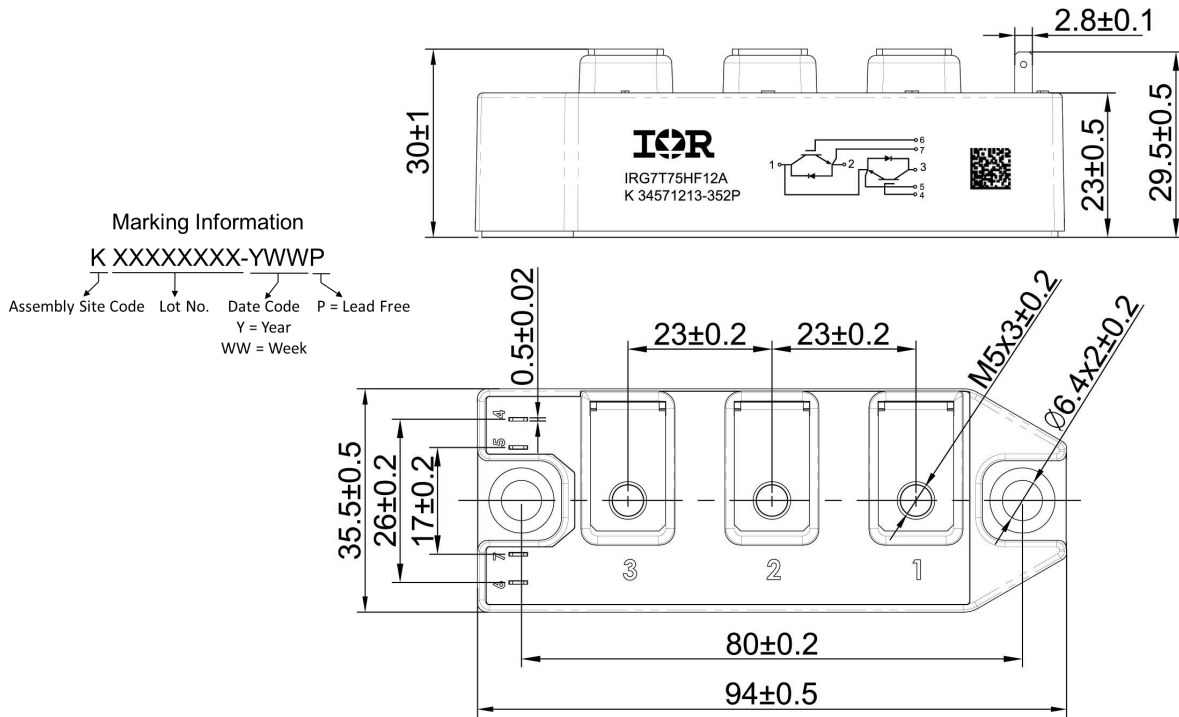

Fig.10 Typical Transient Thermal Impedance (Diode)

Internal Circuit:



Package Outline (Unit: mm):



Qualification Information[†]

Qualification Level	Industrial
Moisture Sensitivity Level	Not Applicable
RoHS Compliant	Yes

[†] Qualification standards can be found at International Rectifier's web site: <http://www.irf.com/product-info/reliability/>