



Chipsmall Limited consists of a professional team with an average of over 10 year of expertise in the distribution of electronic components. Based in Hongkong, we have already established firm and mutual-benefit business relationships with customers from,Europe,America and south Asia,supplying obsolete and hard-to-find components to meet their specific needs.

With the principle of “Quality Parts,Customers Priority,Honest Operation,and Considerate Service”,our business mainly focus on the distribution of electronic components. Line cards we deal with include Microchip,ALPS,ROHM,Xilinx,Pulse,ON,Everlight and Freescale. Main products comprise IC,Modules,Potentiometer,IC Socket,Relay,Connector.Our parts cover such applications as commercial,industrial, and automotives areas.

We are looking forward to setting up business relationship with you and hope to provide you with the best service and solution. Let us make a better world for our industry!



Contact us

Tel: +86-755-8981 8866 Fax: +86-755-8427 6832

Email & Skype: info@chipsmall.com Web: www.chipsmall.com

Address: A1208, Overseas Decoration Building, #122 Zhenhua RD., Futian, Shenzhen, China



IRGP20B60PDPbF

WARP2 SERIES IGBT WITH ULTRAFAST SOFT RECOVERY DIODE

Applications

- Telecom and Server SMPS
- PFC and ZVS SMPS Circuits
- Uninterruptable Power Supplies
- Consumer Electronics Power Supplies
- Lead-Free

Features

- NPT Technology, Positive Temperature Coefficient
- Lower $V_{CE(SAT)}$
- Lower Parasitic Capacitances
- Minimal Tail Current
- HEXFRED Ultra Fast Soft-Recovery Co-Pack Diode
- Tighter Distribution of Parameters
- Higher Reliability

Benefits

- Parallel Operation for Higher Current Applications
- Lower Conduction Losses and Switching Losses
- Higher Switching Frequency up to 150kHz

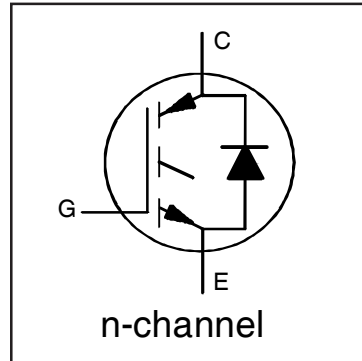

$V_{CES} = 600V$
$V_{CE(on)} \text{ typ.} = 2.05V$ @ $V_{GE} = 15V$ $I_C = 13.0A$
Equivalent MOSFET Parameters ①
$R_{CE(on)} \text{ typ.} = 158m\Omega$
I_D (FET equivalent) = 20A

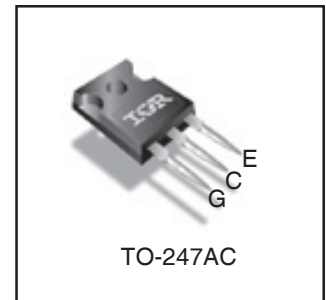

Absolute Maximum Ratings

	Parameter	Max.	Units
V_{CES}	Collector-to-Emitter Voltage	600	V
$I_C @ T_C = 25^\circ C$	Continuous Collector Current	40	A
$I_C @ T_C = 100^\circ C$	Continuous Collector Current	22	
I_{CM}	Pulse Collector Current (Ref. Fig. C.T.4)	80	
I_{LM}	Clamped Inductive Load Current ②	80	
$I_F @ T_C = 25^\circ C$	Diode Continuous Forward Current	31	
$I_F @ T_C = 100^\circ C$	Diode Continuous Forward Current	12	
I_{FRM}	Maximum Repetitive Forward Current ③	42	
V_{GE}	Gate-to-Emitter Voltage	± 20	V
$P_D @ T_C = 25^\circ C$	Maximum Power Dissipation	220	W
$P_D @ T_C = 100^\circ C$	Maximum Power Dissipation	86	
T_J T_{STG}	Operating Junction and Storage Temperature Range	-55 to +150	°C
	Soldering Temperature, for 10 sec.	300 (0.063 in. (1.6mm) from case)	
	Mounting Torque, 6-32 or M3 Screw	10 lbf-in (1.1 N-m)	

Thermal Resistance

	Parameter	Min.	Typ.	Max.	Units
$R_{\theta JC}$ (IGBT)	Thermal Resistance Junction-to-Case-(each IGBT)	—	—	0.58	°C/W
$R_{\theta JC}$ (Diode)	Thermal Resistance Junction-to-Case-(each Diode)	—	—	2.5	
$R_{\theta CS}$	Thermal Resistance, Case-to-Sink (flat, greased surface)	—	0.24	—	
$R_{\theta JA}$	Thermal Resistance, Junction-to-Ambient (typical socket mount)	—	—	40	
	Weight	—	6 (0.21)	—	g (oz)

IRGP20B60PDPbF

Electrical Characteristics @ T_J = 25°C (unless otherwise specified)

International
IOR Rectifier

	Parameter	Min.	Typ.	Max.	Units	Conditions	Ref.Fig
V _{(BR)CES}	Collector-to-Emitter Breakdown Voltage	600	—	—	V	V _{GE} = 0V, I _C = 500μA	
ΔV _{(BR)CES} /ΔT _J	Temperature Coeff. of Breakdown Voltage	—	0.32	—	V/°C	V _{GE} = 0V, I _C = 1mA (25°C-125°C)	
R _G	Internal Gate Resistance	—	4.3	—	Ω	1MHz, Open Collector	
V _{CE(on)}	Collector-to-Emitter Saturation Voltage	—	2.05	2.35	V	I _C = 13A, V _{GE} = 15V	4, 5,6,8,9
		—	2.50	2.80		I _C = 20A, V _{GE} = 15V	
		—	2.65	3.00		I _C = 13A, V _{GE} = 15V, T _J = 125°C	
		—	3.30	3.70		I _C = 20A, V _{GE} = 15V, T _J = 125°C	
V _{GE(th)}	Gate Threshold Voltage	3.0	4.0	5.0	V	I _C = 250μA	7,8,9
ΔV _{GE(th)} /ΔT _J	Threshold Voltage temp. coefficient	—	-11	—	mV/°C	V _{CE} = V _{GE} , I _C = 1.0mA	
g _{fe}	Forward Transconductance	—	19	—	S	V _{CE} = 50V, I _C = 40A, PW = 80μs	
I _{CES}	Collector-to-Emitter Leakage Current	—	1.0	250	μA	V _{GE} = 0V, V _{CE} = 600V	
		—	0.1	—	mA	V _{GE} = 0V, V _{CE} = 600V, T _J = 125°C	
V _{FM}	Diode Forward Voltage Drop	—	1.4	1.7	V	I _F = 12A, V _{GE} = 0V	10
		—	1.3	1.6		I _F = 12A, V _{GE} = 0V, T _J = 125°C	
I _{GES}	Gate-to-Emitter Leakage Current	—	—	±100	nA	V _{GE} = ±20V, V _{CE} = 0V	

Switching Characteristics @ T_J = 25°C (unless otherwise specified)

	Parameter	Min.	Typ.	Max.	Units	Conditions	Ref.Fig	
Q _g	Total Gate Charge (turn-on)	—	68	102	nC	I _C = 13A	17	
Q _{gc}	Gate-to-Collector Charge (turn-on)	—	24	36		V _{CC} = 400V	CT1	
Q _{ge}	Gate-to-Emitter Charge (turn-on)	—	10	15		V _{GE} = 15V		
E _{on}	Turn-On Switching Loss	—	95	140	μJ	I _C = 13A, V _{CC} = 390V	CT3	
E _{off}	Turn-Off Switching Loss	—	100	145		V _{GE} = +15V, R _G = 10Ω, L = 200μH		
E _{total}	Total Switching Loss	—	195	285		T _J = 25°C ④		
t _{d(on)}	Turn-On delay time	—	20	26	ns	I _C = 13A, V _{CC} = 390V	CT3	
t _r	Rise time	—	5.0	7.0		V _{GE} = +15V, R _G = 10Ω, L = 200μH		
t _{d(off)}	Turn-Off delay time	—	115	135		T _J = 25°C ④		
t _f	Fall time	—	6.0	8.0				
E _{on}	Turn-On Switching Loss	—	165	215	μJ	I _C = 13A, V _{CC} = 390V	CT3	
E _{off}	Turn-Off Switching Loss	—	150	195		V _{GE} = +15V, R _G = 10Ω, L = 200μH		
E _{total}	Total Switching Loss	—	315	410		T _J = 125°C ④		
t _{d(on)}	Turn-On delay time	—	19	25	ns	I _C = 13A, V _{CC} = 390V	CT3	
t _r	Rise time	—	6.0	8.0		V _{GE} = +15V, R _G = 10Ω, L = 200μH		
t _{d(off)}	Turn-Off delay time	—	125	140		T _J = 125°C ④		
t _f	Fall time	—	13	17				
C _{ies}	Input Capacitance	—	1570	—	pF	V _{GE} = 0V	16	
C _{oes}	Output Capacitance	—	130	—		V _{CC} = 30V		
C _{res}	Reverse Transfer Capacitance	—	20	—		f = 1Mhz		
C _{oes eff.}	Effective Output Capacitance (Time Related) ⑤	—	94	—		V _{GE} = 0V, V _{CE} = 0V to 480V		15
C _{oes eff. (ER)}	Effective Output Capacitance (Energy Related) ⑤	—	76	—				
RBSOA	Reverse Bias Safe Operating Area	FULL SQUARE				T _J = 150°C, I _C = 80A V _{CC} = 480V, V _p = 600V R _g = 22Ω, V _{GE} = +15V to 0V	3 CT2	
t _{rr}	Diode Reverse Recovery Time	—	42	60	ns	T _J = 25°C I _F = 12A, V _R = 200V,	19	
		—	80	120		T _J = 125°C di/dt = 200A/μs		
Q _{rr}	Diode Reverse Recovery Charge	—	80	180	nC	T _J = 25°C I _F = 12A, V _R = 200V,	21	
		—	220	600		T _J = 125°C di/dt = 200A/μs		
I _{rr}	Peak Reverse Recovery Current	—	3.5	6.0	A	T _J = 25°C I _F = 12A, V _R = 200V,	19,20,21,22	
		—	5.6	10		T _J = 125°C di/dt = 200A/μs		

Notes:

- R_{CE(on)} typ. = equivalent on-resistance = V_{CE(on)} typ. / I_C, where V_{CE(on)} typ. = 2.05V and I_C = 13A. I_D (FET Equivalent) is the equivalent MOSFET I_D rating @ 25°C for applications up to 150kHz. These are provided for comparison purposes (only) with equivalent MOSFET solutions.
- V_{CC} = 80% (V_{CES}), V_{GE} = 15V, L = 28μH, R_G = 22Ω.
- Pulse width limited by max. junction temperature.
- Energy losses include "tail" and diode reverse recovery. Data generated with use of Diode 8ETH06.
- C_{oes eff.} is a fixed capacitance that gives the same charging time as C_{oes} while V_{CE} is rising from 0 to 80% V_{CES}.
C_{oes eff. (ER)} is a fixed capacitance that stores the same energy as C_{oes} while V_{CE} is rising from 0 to 80% V_{CES}.

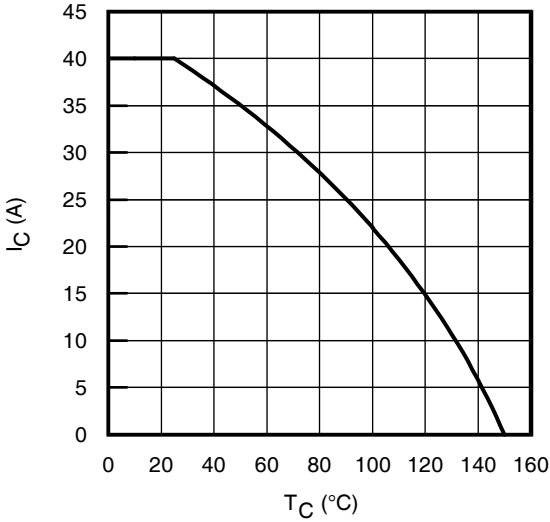

Fig. 1 - Maximum DC Collector Current vs. Case Temperature

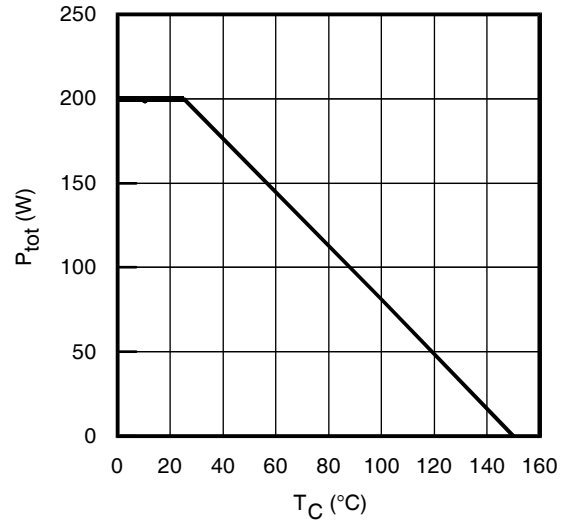

Fig. 2 - Power Dissipation vs. Case Temperature

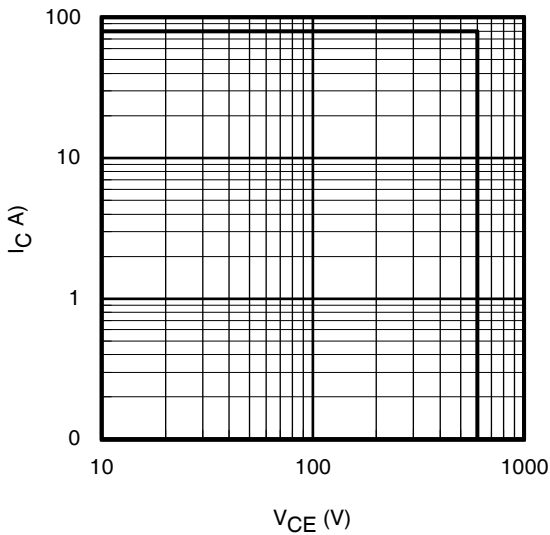

Fig. 3 - Reverse Bias SOA
 $T_J = 150^\circ\text{C}$; $V_{GE} = 15\text{V}$

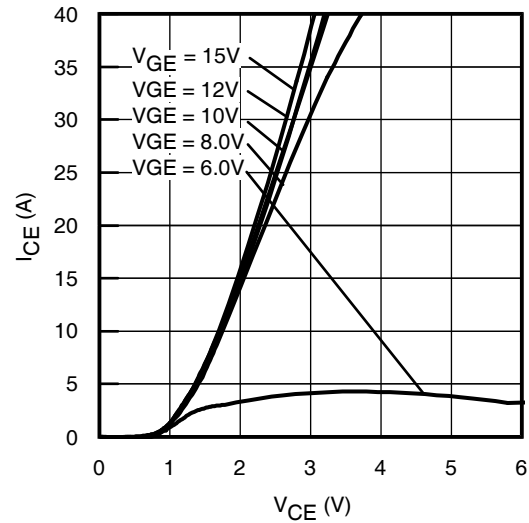

Fig. 4 - Typ. IGBT Output Characteristics
 $T_J = -40^\circ\text{C}$; $t_p = 80\mu\text{s}$

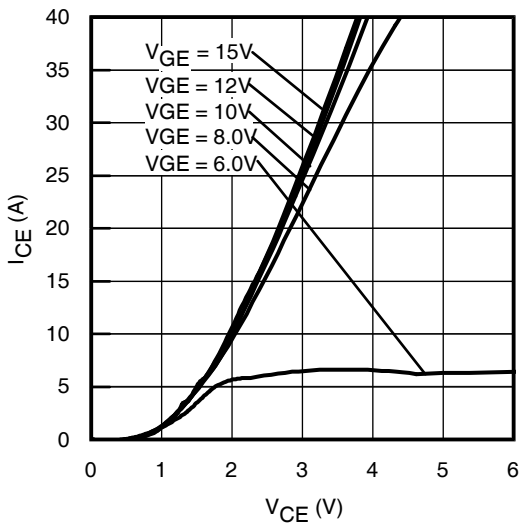

Fig. 5 - Typ. IGBT Output Characteristics
 $T_J = 25^\circ\text{C}$; $t_p = 80\mu\text{s}$

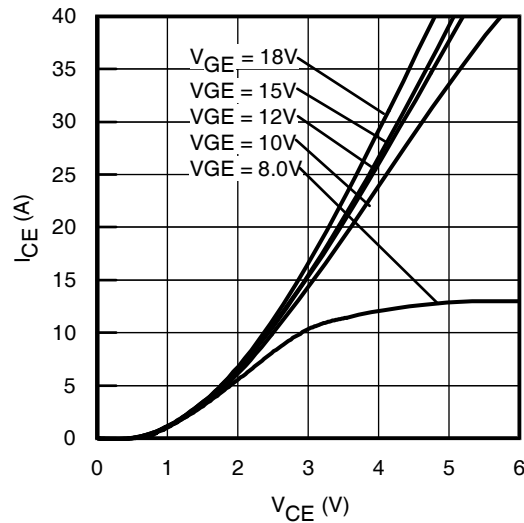

Fig. 6 - Typ. IGBT Output Characteristics
 $T_J = 125^\circ\text{C}$; $t_p = 80\mu\text{s}$

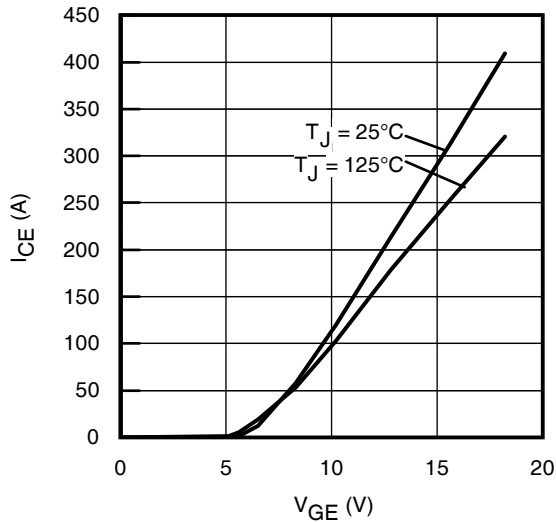

Fig. 7 - Typ. Transfer Characteristics
 $V_{CE} = 50V$; $t_p = 10\mu s$

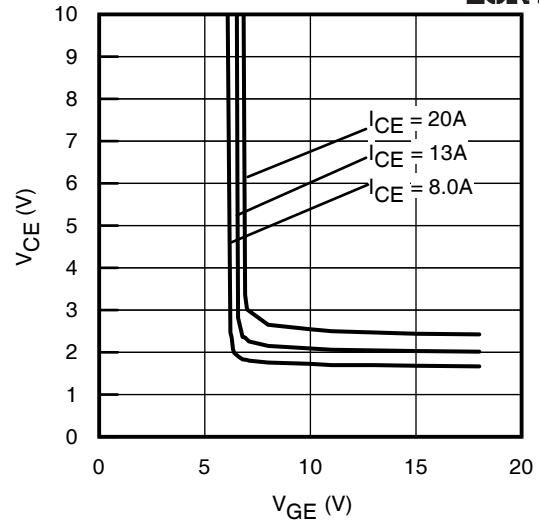

Fig. 8 - Typical V_{CE} vs. V_{GE}
 $T_J = 25^\circ C$

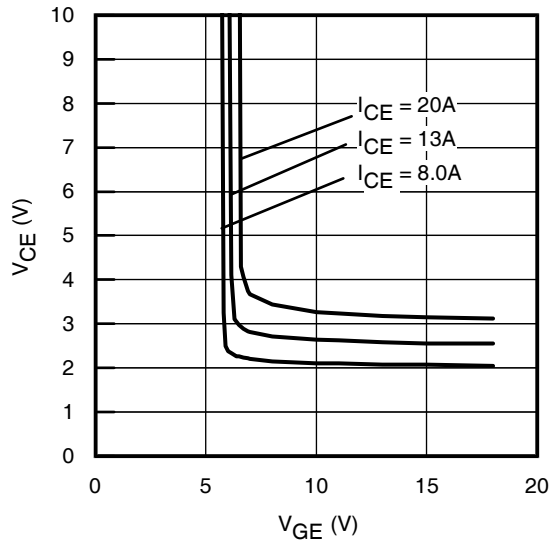

Fig. 9 - Typical V_{CE} vs. V_{GE}
 $T_J = 125^\circ C$

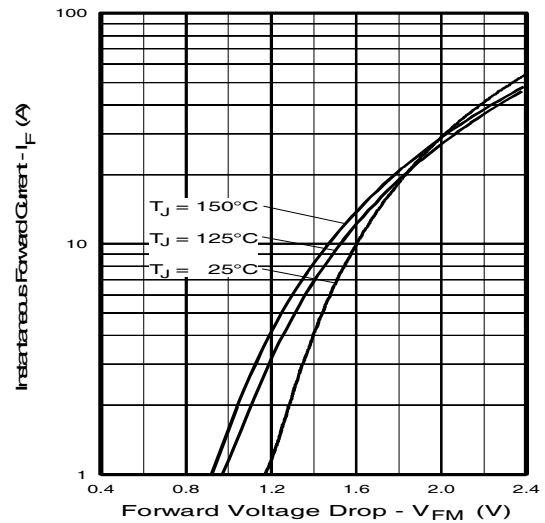

Fig. 10 - Typ. Diode Forward Characteristics
 $t_p = 80\mu s$

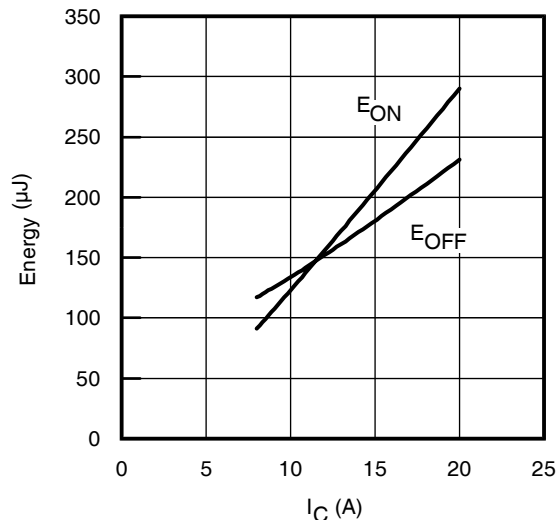

Fig. 11 - Typ. Energy Loss vs. I_C
 $T_J = 125^\circ C$; $L = 200\mu H$; $V_{CE} = 390V$, $R_G = 10\Omega$; $V_{GE} = 15V$.
Diode clamp used: 8ETH06 (See C.T.3)

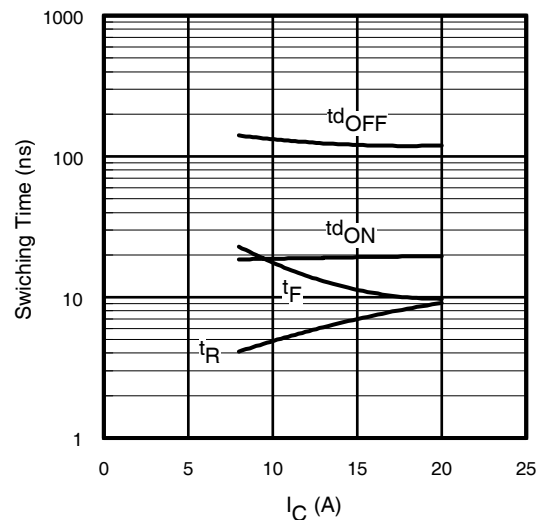

Fig. 12 - Typ. Switching Time vs. I_C
 $T_J = 125^\circ C$; $L = 200\mu H$; $V_{CE} = 390V$, $R_G = 10\Omega$; $V_{GE} = 15V$.
Diode clamp used: 8ETH06 (See C.T.3)

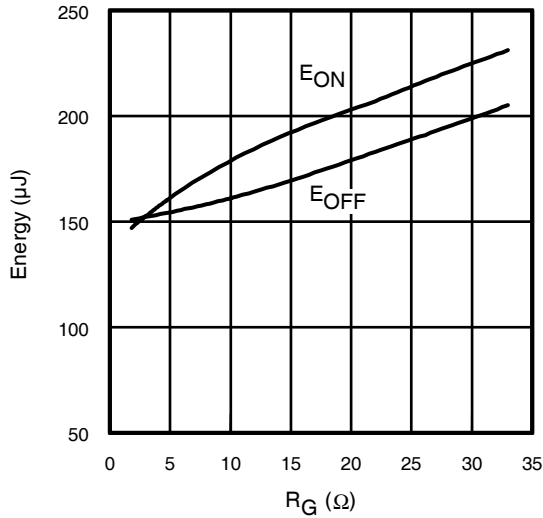

Fig. 13 - Typ. Energy Loss vs. R_G
 $T_J = 125^\circ\text{C}$; $L = 200\mu\text{H}$; $V_{CE} = 390\text{V}$; $I_{CE} = 13\text{A}$; $V_{GE} = 15\text{V}$
 Diode clamp used: 8ETH06 (See C.T.3)

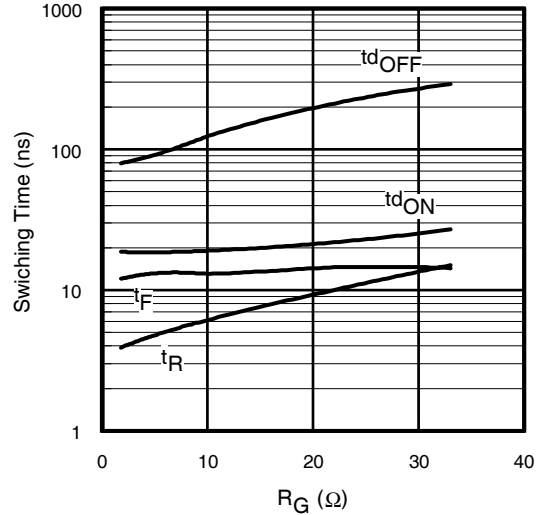

Fig. 14 - Typ. Switching Time vs. R_G
 $T_J = 125^\circ\text{C}$; $L = 200\mu\text{H}$; $V_{CE} = 390\text{V}$; $I_{CE} = 13\text{A}$; $V_{GE} = 15\text{V}$
 Diode clamp used: 8ETH06 (See C.T.3)

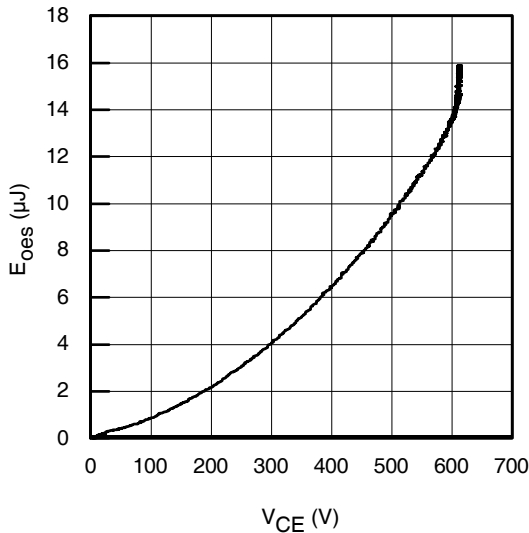

Fig. 15- Typ. Output Capacitance Stored Energy vs. V_{CE}

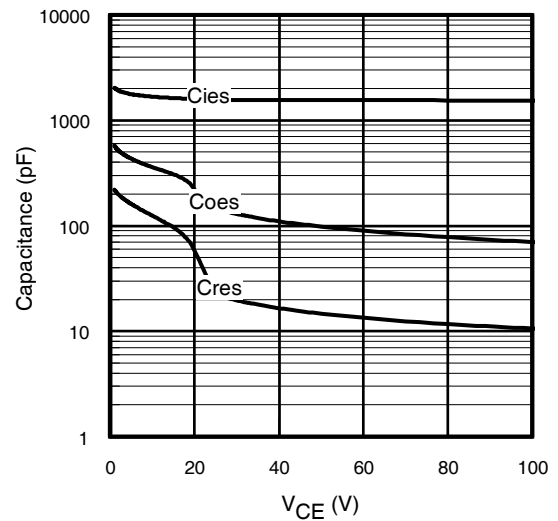

Fig. 16- Typ. Capacitance vs. V_{CE}
 $V_{GE} = 0\text{V}$; $f = 1\text{MHz}$

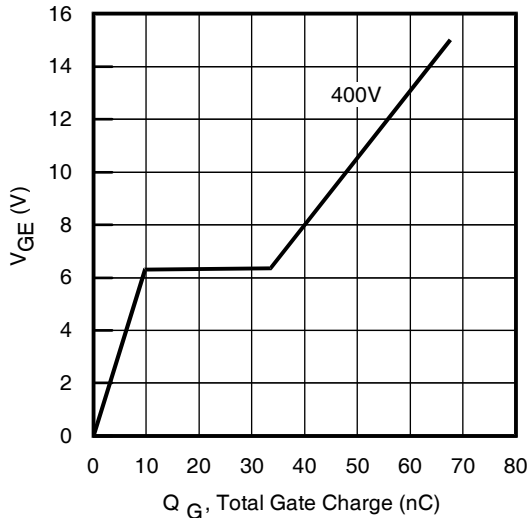

Fig. 17 - Typical Gate Charge vs. V_{GE}
 $I_{CE} = 13\text{A}$

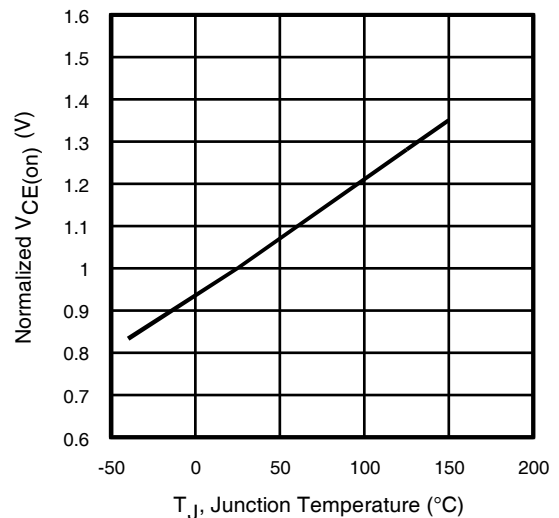

Fig. 18 - Normalized Typical $V_{CE(on)}$ vs. Junction Temperature
 $I_{CE} = 13\text{A}$, $V_{GE} = 15\text{V}$

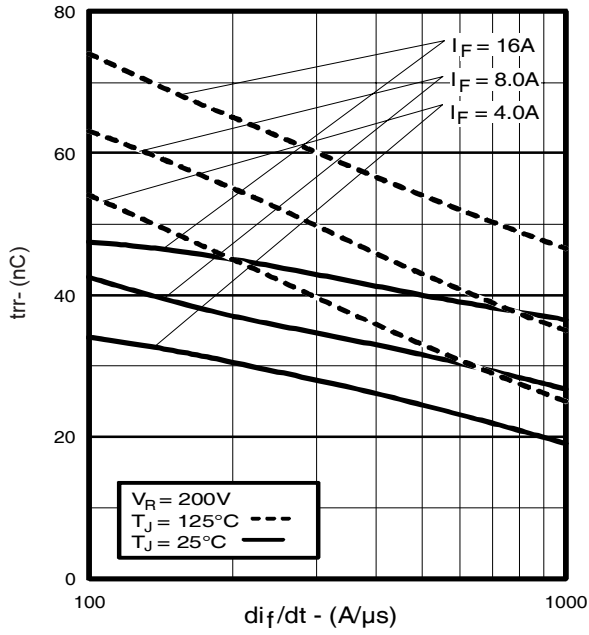

Fig. 19 - Typical Reverse Recovery vs. di_f/dt

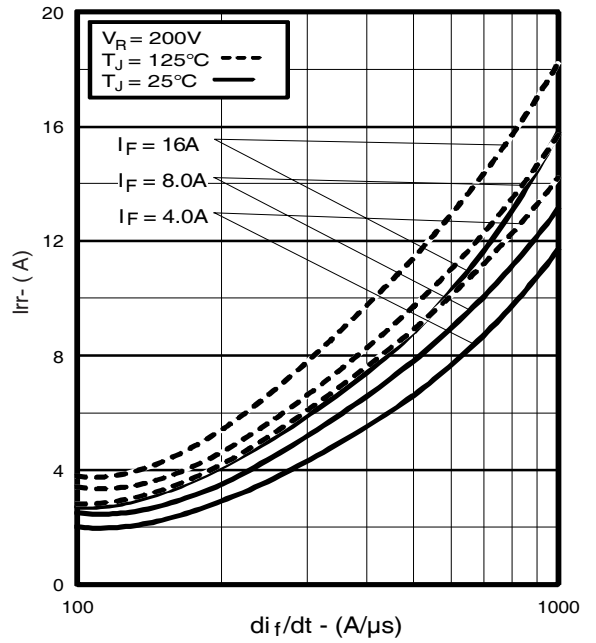

Fig. 20 - Typical Recovery Current vs. di_f/dt

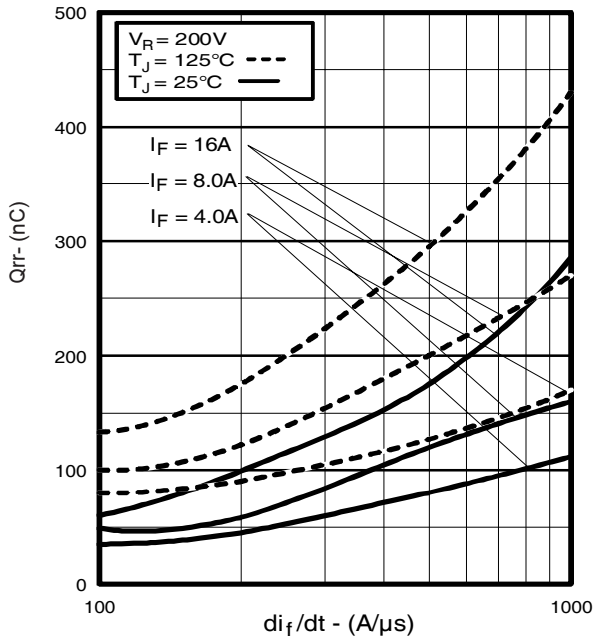

Fig. 21 - Typical Stored Charge vs. di_f/dt

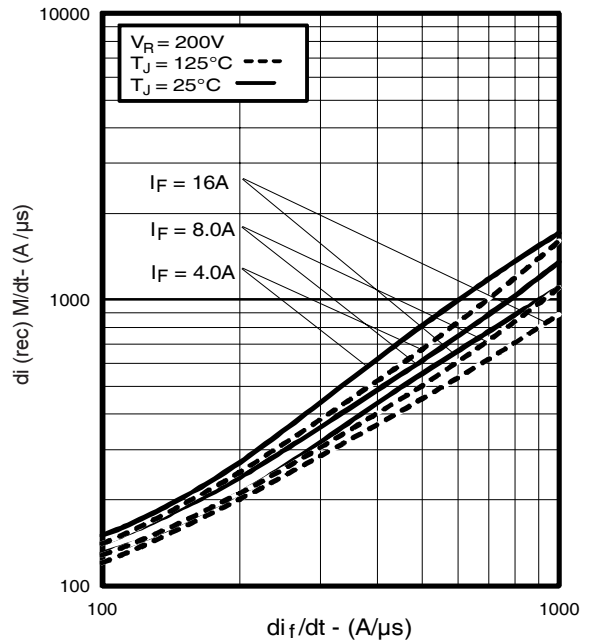

Fig. 22 - Typical $di_{(rec)M}/dt$ vs. di_f/dt

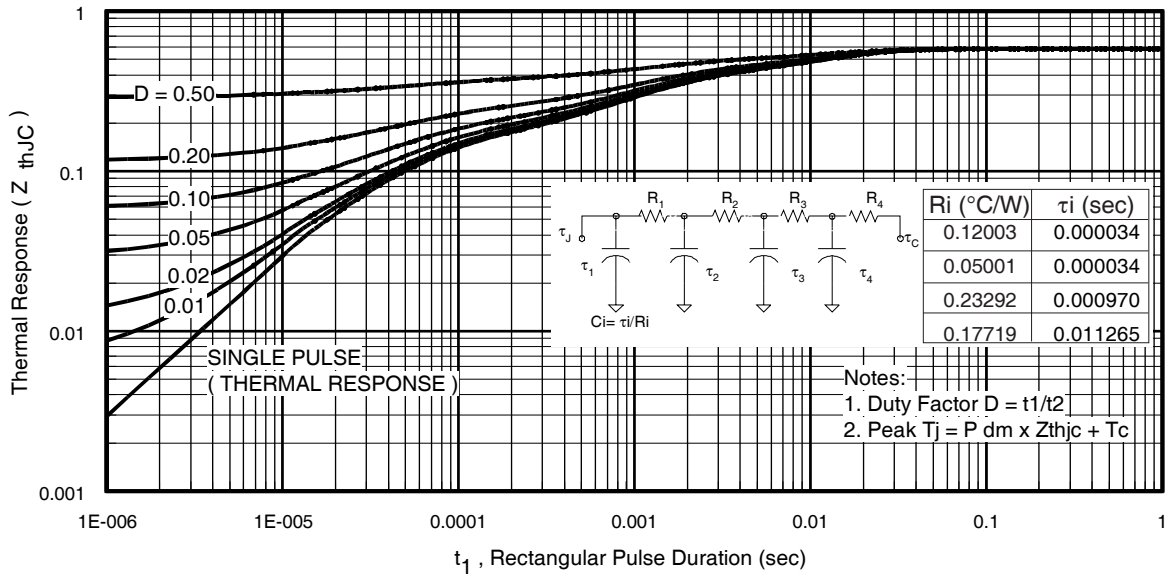

Fig 23. Maximum Transient Thermal Impedance, Junction-to-Case (IGBT)

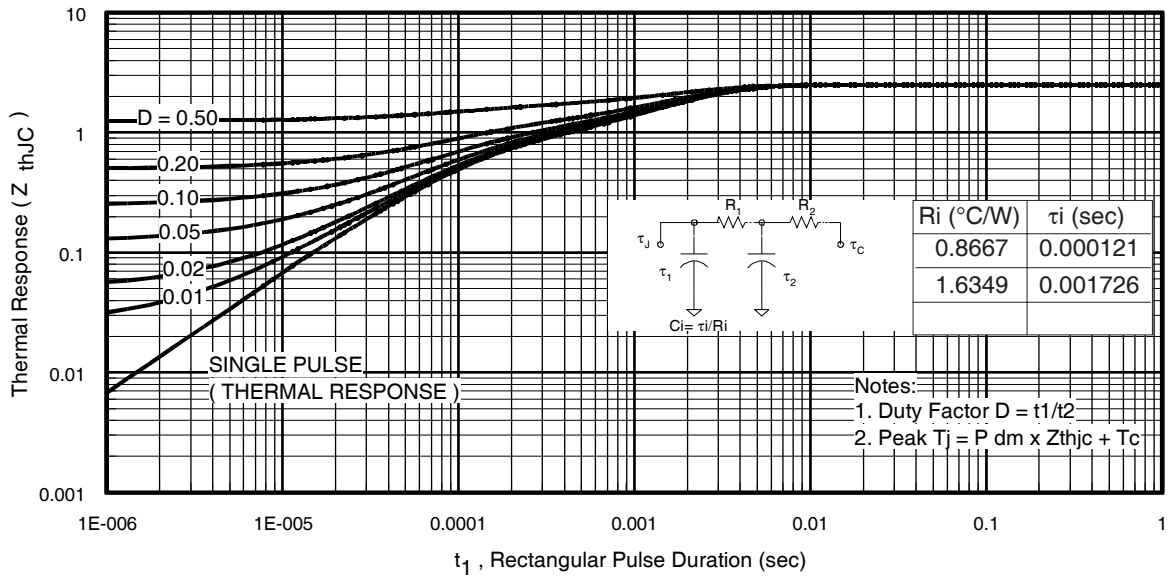

Fig. 24. Maximum Transient Thermal Impedance, Junction-to-Case (DIODE)

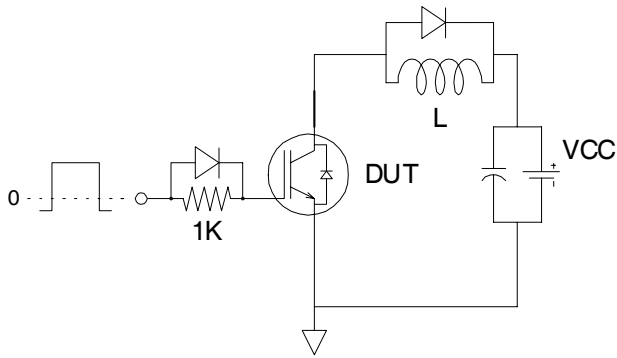

Fig.C.T.1 - Gate Charge Circuit (turn-off)

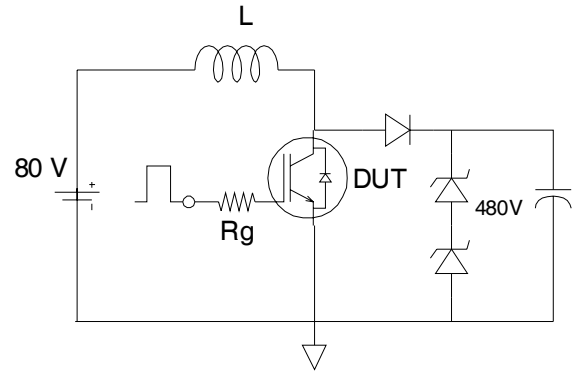

Fig.C.T.2 - RBSOA Circuit

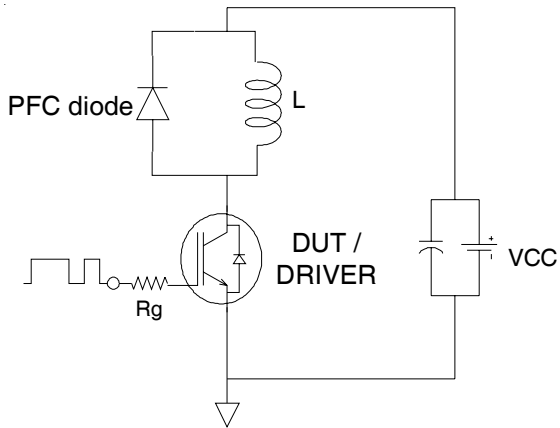

Fig.C.T.3 - Switching Loss Circuit

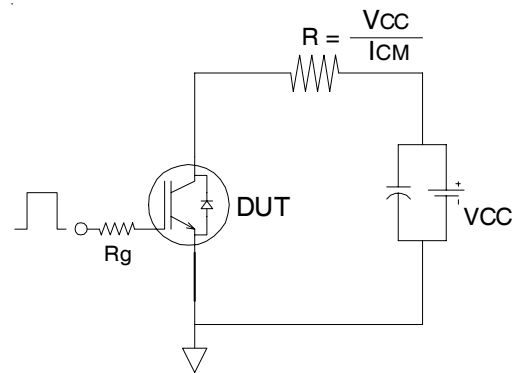

Fig.C.T.4 - Resistive Load Circuit

REVERSE RECOVERY CIRCUIT

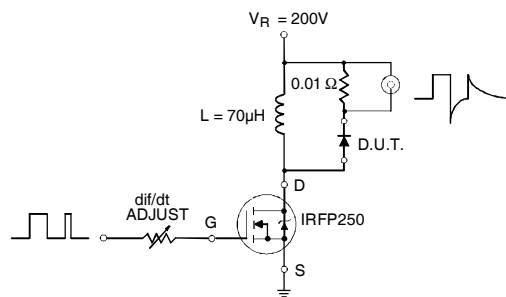

Fig. C.T.5 - Reverse Recovery Parameter Test Circuit

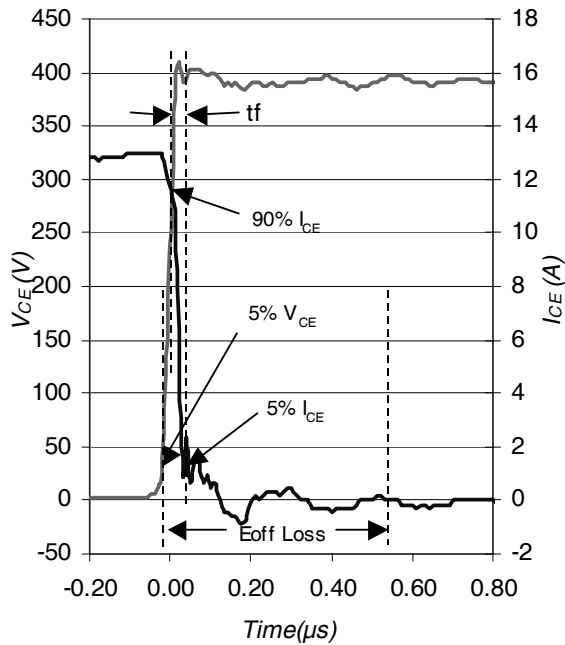

Fig. WF1 - Typ. Turn-off Loss Waveform
@ $T_J = 125^\circ\text{C}$ using Fig. CT.3

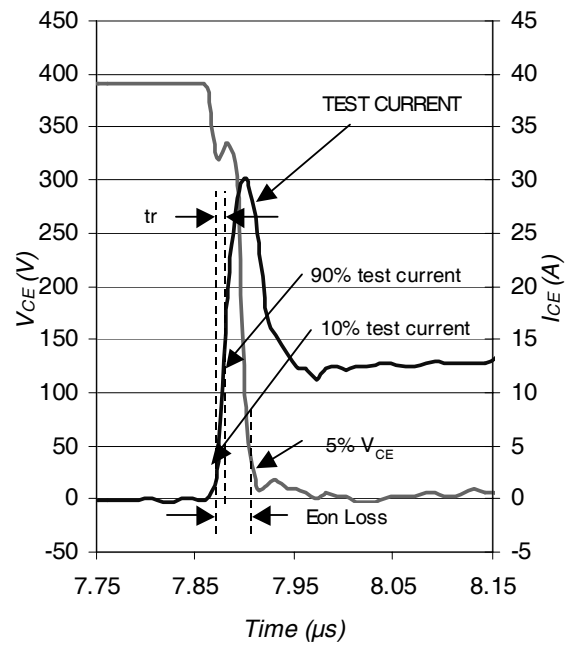

Fig. WF2 - Typ. Turn-on Loss Waveform
@ $T_J = 125^\circ\text{C}$ using Fig. CT.3

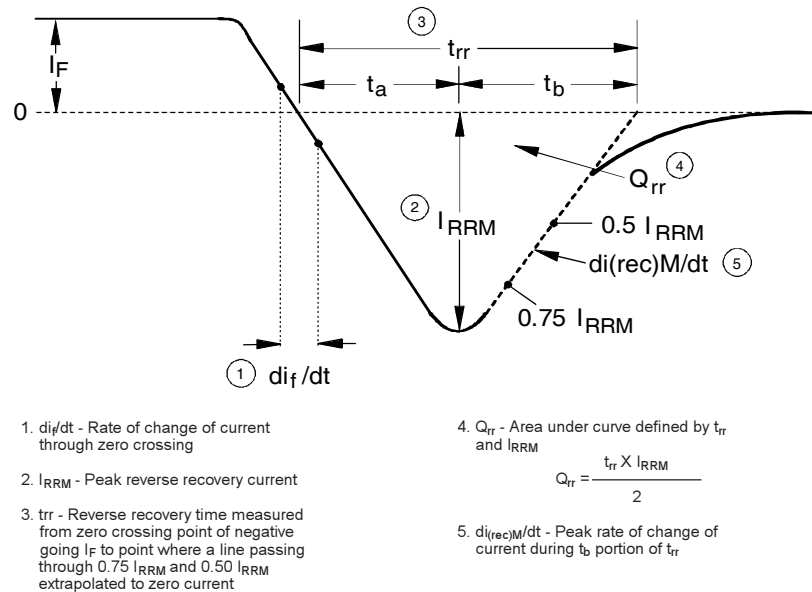
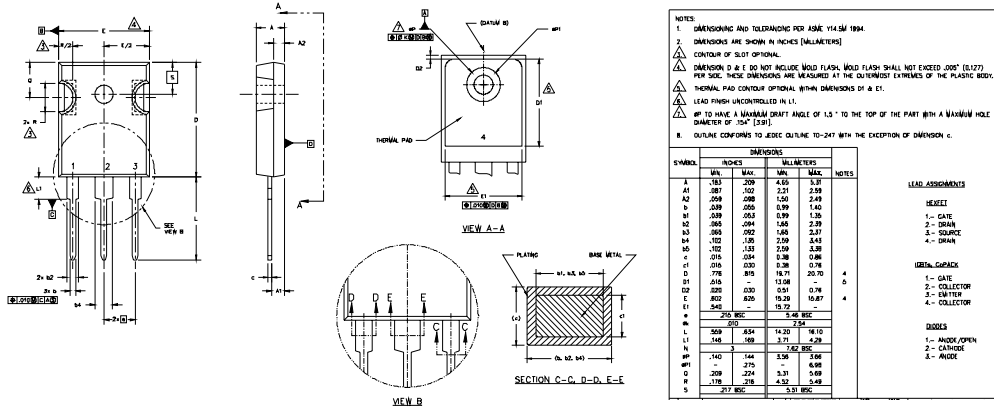

Fig. WF3 - Reverse Recovery Waveform and Definitions

TO-247AC Package Outline

Dimensions are shown in millimeters (inches)



TO-247AC Part Marking Information

EXAMPLE: THIS IS AN IRFP30
WITH ASSEMBLY
LOT CODE 5657
ASSEMBLED ON WW 35, 2000
IN THE ASSEMBLY LINE "H"
Note: "P" in assembly line
position indicates "Lead-Free"

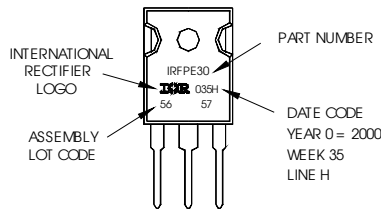

TO-247AC package is not recommended for Surface Mount Application.

Data and specifications subject to change without notice.
This product has been designed and qualified for Industrial market.
Qualification Standards can be found on IR's Web site.

International
IR Rectifier

IR WORLD HEADQUARTERS: 233 Kansas St., El Segundo, California 90245, USA Tel: (310) 252-7105

TAC Fax: (310) 252-7903

Visit us at www.irf.com for sales contact information. 07/04

Note: For the most current drawings please refer to the IR website at:
<http://www.irf.com/package/>