



Chipsmall Limited consists of a professional team with an average of over 10 year of expertise in the distribution of electronic components. Based in Hongkong, we have already established firm and mutual-benefit business relationships with customers from,Europe,America and south Asia,supplying obsolete and hard-to-find components to meet their specific needs.

With the principle of “Quality Parts,Customers Priority,Honest Operation,and Considerate Service”,our business mainly focus on the distribution of electronic components. Line cards we deal with include Microchip,ALPS,ROHM,Xilinx,Pulse,ON,Everlight and Freescale. Main products comprise IC,Modules,Potentiometer,IC Socket,Relay,Connector.Our parts cover such applications as commercial,industrial, and automotives areas.

We are looking forward to setting up business relationship with you and hope to provide you with the best service and solution. Let us make a better world for our industry!



Contact us

Tel: +86-755-8981 8866 Fax: +86-755-8427 6832

Email & Skype: info@chipsmall.com Web: www.chipsmall.com

Address: A1208, Overseas Decoration Building, #122 Zhenhua RD., Futian, Shenzhen, China



WARP2 SERIES IGBT WITH
 ULTRAFAST SOFT RECOVERY DIODE

Applications

- Telecom and Server SMPS
- PFC and ZVS SMPS Circuits
- Uninterruptable Power Supplies
- Consumer Electronics Power Supplies
- Lead-Free

Features

- NPT Technology, Positive Temperature Coefficient
- Lower $V_{CE(SAT)}$
- Lower Parasitic Capacitances
- Minimal Tail Current
- HEXFRED Ultra Fast Soft-Recovery Co-Pack Diode
- Tighter Distribution of Parameters
- Higher Reliability

Benefits

- Parallel Operation for Higher Current Applications
- Lower Conduction Losses and Switching Losses
- Higher Switching Frequency up to 150kHz

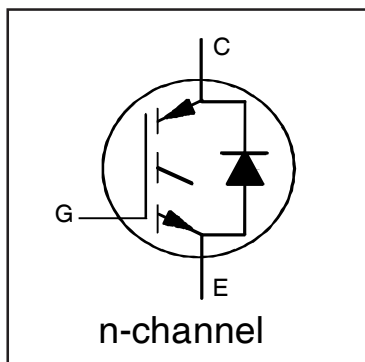

$$V_{CES} = 600V$$

$$V_{CE(on)} \text{ typ.} = 2.00V$$

$$@ V_{GE} = 15V \quad I_C = 33A$$

Equivalent MOSFET Parameters^①

$$R_{CE(on)} \text{ typ.} = 61m\Omega$$

$$I_D \text{ (FET equivalent)} = 50A$$

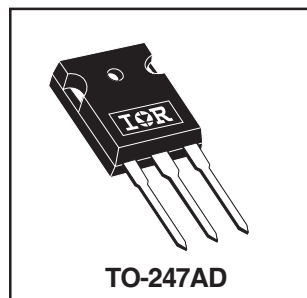
**Absolute Maximum Ratings**

	Parameter	Max.	Units	
V_{CES}	Collector-to-Emitter Voltage	600	V	
$I_C @ T_C = 25^\circ C$	Continuous Collector Current	75	A	
$I_C @ T_C = 100^\circ C$	Continuous Collector Current	45		
I_{CM}	Pulse Collector Current (Ref. Fig. C.T.4)	150		
I_{LM}	Clamped Inductive Load Current ^②	150		
$I_F @ T_C = 25^\circ C$	Diode Continuous Forward Current	40		
$I_F @ T_C = 100^\circ C$	Diode Continuous Forward Current	15		
I_{FRM}	Maximum Repetitive Forward Current ^③	60		
V_{GE}	Gate-to-Emitter Voltage	± 20		V
$P_D @ T_C = 25^\circ C$	Maximum Power Dissipation	390		W
$P_D @ T_C = 100^\circ C$	Maximum Power Dissipation	156		
T_J	Operating Junction and	-55 to +150	$^\circ C$	
T_{STG}	Storage Temperature Range			
	Soldering Temperature for 10 sec.	300 (0.063 in. (1.6mm) from case)		
	Mounting Torque, 6-32 or M3 Screw	10 lbf-in (1.1 N-m)		

Thermal Resistance

	Parameter	Min.	Typ.	Max.	Units
$R_{\theta JC}$ (IGBT)	Thermal Resistance Junction-to-Case-(each IGBT)	—	—	0.32	$^\circ C/W$
$R_{\theta JC}$ (Diode)	Thermal Resistance Junction-to-Case-(each Diode)	—	—	1.7	
$R_{\theta CS}$	Thermal Resistance, Case-to-Sink (flat, greased surface)	—	0.24	—	
$R_{\theta JA}$	Thermal Resistance, Junction-to-Ambient (typical socket mount)	—	—	40	
	Weight	—	6.0 (0.21)	—	g (oz)

Electrical Characteristics @ T_J = 25°C (unless otherwise specified)

	Parameter	Min.	Typ.	Max.	Units	Conditions	Ref.Fig
V _{(BR)CES}	Collector-to-Emitter Breakdown Voltage	600	—	—	V	V _{GE} = 0V, I _C = 500μA	
ΔV _{(BR)CES} /ΔT _J	Temperature Coeff. of Breakdown Voltage	—	0.31	—	V/°C	V _{GE} = 0V, I _C = 1mA (25°C-125°C)	
R _G	Internal Gate Resistance	—	1.7	—	Ω	1MHz, Open Collector	
V _{CE(on)}	Collector-to-Emitter Saturation Voltage	—	2.00	2.35	V	I _C = 33A, V _{GE} = 15V	4, 5,6,8,9
		—	2.45	2.85		I _C = 50A, V _{GE} = 15V	
		—	2.60	2.95		I _C = 33A, V _{GE} = 15V, T _J = 125°C	
		—	3.20	3.60		I _C = 50A, V _{GE} = 15V, T _J = 125°C	
V _{GE(th)}	Gate Threshold Voltage	3.0	4.0	5.0	V	I _C = 250μA	7,8,9
ΔV _{GE(th)} /ΔT _J	Threshold Voltage temp. coefficient	—	-10	—	mV/°C	V _{CE} = V _{GE} , I _C = 1.0mA	
g _{fe}	Forward Transconductance	—	41	—	S	V _{CE} = 50V, I _C = 33A, PW = 80μs	
I _{CES}	Collector-to-Emitter Leakage Current	—	5.0	500	μA	V _{GE} = 0V, V _{CE} = 600V	
		—	1.0	—	mA	V _{GE} = 0V, V _{CE} = 600V, T _J = 125°C	
V _{FM}	Diode Forward Voltage Drop	—	1.30	1.70	V	I _F = 15A, V _{GE} = 0V	10
		—	1.20	1.60		I _F = 15A, V _{GE} = 0V, T _J = 125°C	
I _{GES}	Gate-to-Emitter Leakage Current	—	—	±100	nA	V _{GE} = ±20V, V _{CE} = 0V	

Switching Characteristics @ T_J = 25°C (unless otherwise specified)

	Parameter	Min.	Typ.	Max.	Units	Conditions	Ref.Fig	
Q _g	Total Gate Charge (turn-on)	—	205	308	nC	I _C = 33A	17	
Q _{gc}	Gate-to-Collector Charge (turn-on)	—	70	105		V _{CC} = 400V	CT1	
Q _{ge}	Gate-to-Emitter Charge (turn-on)	—	30	45		V _{GE} = 15V		
E _{on}	Turn-On Switching Loss	—	255	305	μJ	I _C = 33A, V _{CC} = 390V	CT3	
E _{off}	Turn-Off Switching Loss	—	375	445		V _{GE} = +15V, R _G = 3.3Ω, L = 200μH		
E _{total}	Total Switching Loss	—	630	750		T _J = 25°C ④		
t _{d(on)}	Turn-On delay time	—	30	40	ns	I _C = 33A, V _{CC} = 390V	CT3	
t _r	Rise time	—	10	15		V _{GE} = +15V, R _G = 3.3Ω, L = 200μH		
t _{d(off)}	Turn-Off delay time	—	130	150		T _J = 25°C ④		
t _f	Fall time	—	11	15				
E _{on}	Turn-On Switching Loss	—	580	700		I _C = 33A, V _{CC} = 390V		CT3
E _{off}	Turn-Off Switching Loss	—	480	550	V _{GE} = +15V, R _G = 3.3Ω, L = 200μH	11,13		
E _{total}	Total Switching Loss	—	1060	1250		T _J = 125°C ④	WF1,WF2	
t _{d(on)}	Turn-On delay time	—	26	35	ns	I _C = 33A, V _{CC} = 390V	CT3	
t _r	Rise time	—	13	20		V _{GE} = +15V, R _G = 3.3Ω, L = 200μH		
t _{d(off)}	Turn-Off delay time	—	146	165		T _J = 125°C ④		
t _f	Fall time	—	15	20				
E _{on}	Turn-On Switching Loss	—	580	700		I _C = 33A, V _{CC} = 390V		CT3
E _{off}	Turn-Off Switching Loss	—	480	550	V _{GE} = +15V, R _G = 3.3Ω, L = 200μH	11,13		
E _{total}	Total Switching Loss	—	1060	1250		T _J = 125°C ④	WF1,WF2	
t _{d(on)}	Turn-On delay time	—	26	35	pF	I _C = 33A, V _{CC} = 390V	CT3	
t _r	Rise time	—	13	20		V _{GE} = +15V, R _G = 3.3Ω, L = 200μH		
t _{d(off)}	Turn-Off delay time	—	146	165		T _J = 125°C ④		
t _f	Fall time	—	15	20				
E _{on}	Turn-On Switching Loss	—	580	700		I _C = 33A, V _{CC} = 390V		CT3
C _{ies}	Input Capacitance	—	3648	—	pF	V _{GE} = 0V	16	
C _{oes}	Output Capacitance	—	322	—		V _{CC} = 30V		
C _{res}	Reverse Transfer Capacitance	—	56	—		f = 1Mhz		
C _{oes eff.}	Effective Output Capacitance (Time Related) ⑤	—	215	—		V _{GE} = 0V, V _{CE} = 0V to 480V		15
C _{oes eff. (ER)}	Effective Output Capacitance (Energy Related) ⑤	—	163	—				
RBSOA	Reverse Bias Safe Operating Area	FULL SQUARE				T _J = 150°C, I _C = 150A V _{CC} = 480V, V _p = 600V R _G = 22Ω, V _{GE} = +15V to 0V	3 CT2	
t _{rr}	Diode Reverse Recovery Time	—	42	60	ns	T _J = 25°C I _F = 15A, V _R = 200V,	19	
		—	74	120		T _J = 125°C di/dt = 200A/μs		
Q _{rr}	Diode Reverse Recovery Charge	—	80	180	nC	T _J = 25°C I _F = 15A, V _R = 200V,	21	
		—	220	600		T _J = 125°C di/dt = 200A/μs		
I _{rr}	Peak Reverse Recovery Current	—	4.0	6.0	A	T _J = 25°C I _F = 15A, V _R = 200V,	19,20,21,22	
		—	6.5	10		T _J = 125°C di/dt = 200A/μs		

Notes:

- ① R_{CE(on)} typ. = equivalent on-resistance = V_{CE(on)} typ. / I_C, where V_{CE(on)} typ. = 2.00V and I_C = 33A. I_D (FET Equivalent) is the equivalent MOSFET I_D rating @ 25°C for applications up to 150kHz. These are provided for comparison purposes (only) with equivalent MOSFET solutions.
- ② V_{CC} = 80% (V_{CES}), V_{GE} = 15V, L = 28 μH, R_G = 22 Ω.
- ③ Pulse width limited by max. junction temperature.
- ④ Energy losses include "tail" and diode reverse recovery, Data generated with use of Diode 30ETH06.
- ⑤ C_{oes eff.} is a fixed capacitance that gives the same charging time as C_{oes} while V_{CE} is rising from 0 to 80% V_{CES}.
C_{oes eff. (ER)} is a fixed capacitance that stores the same energy as C_{oes} while V_{CE} is rising from 0 to 80% V_{CES}.

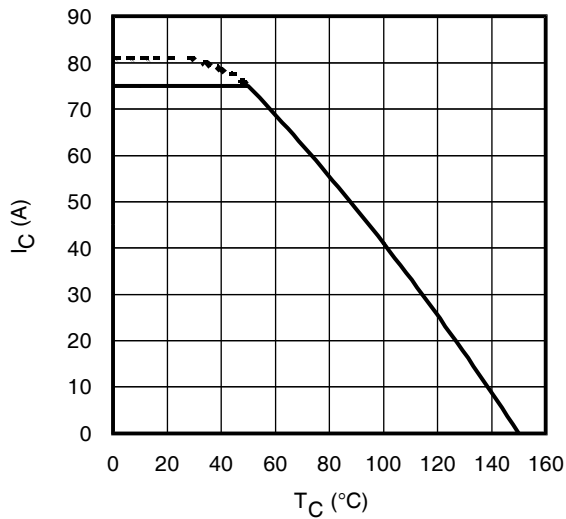

Fig. 1 - Maximum DC Collector Current vs. Case Temperature

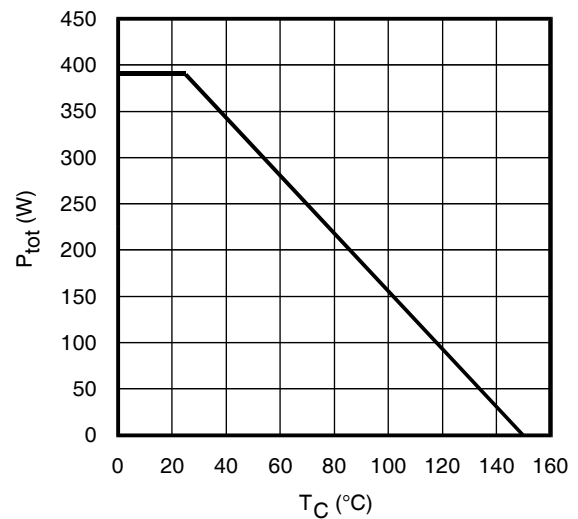

Fig. 2 - Power Dissipation vs. Case Temperature

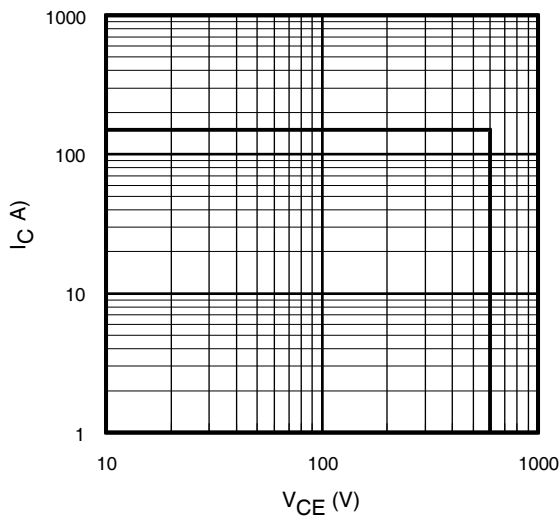

Fig. 3 - Reverse Bias SOA
 $T_J = 150^\circ\text{C}$; $V_{GE} = 15\text{V}$

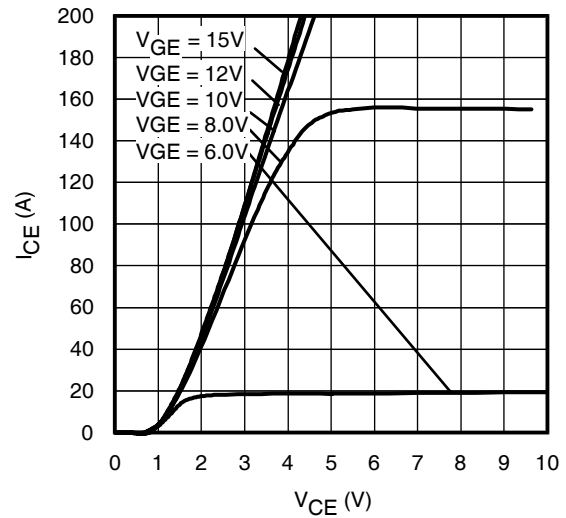

Fig. 4 - Typ. IGBT Output Characteristics
 $T_J = -40^\circ\text{C}$; $t_p = 80\mu\text{s}$

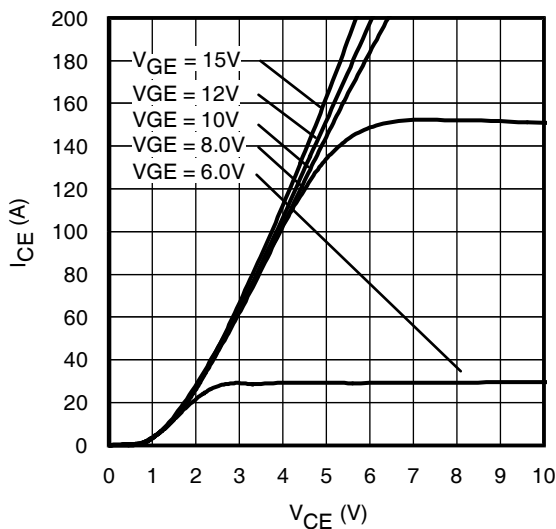

Fig. 5 - Typ. IGBT Output Characteristics
 $T_J = 25^\circ\text{C}$; $t_p = 80\mu\text{s}$

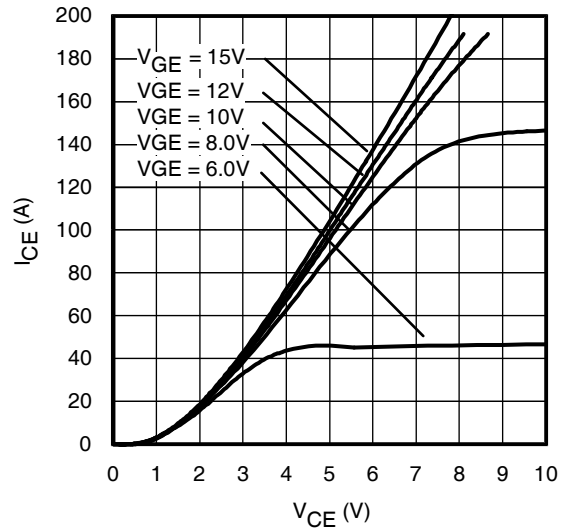

Fig. 6 - Typ. IGBT Output Characteristics
 $T_J = 125^\circ\text{C}$; $t_p = 80\mu\text{s}$

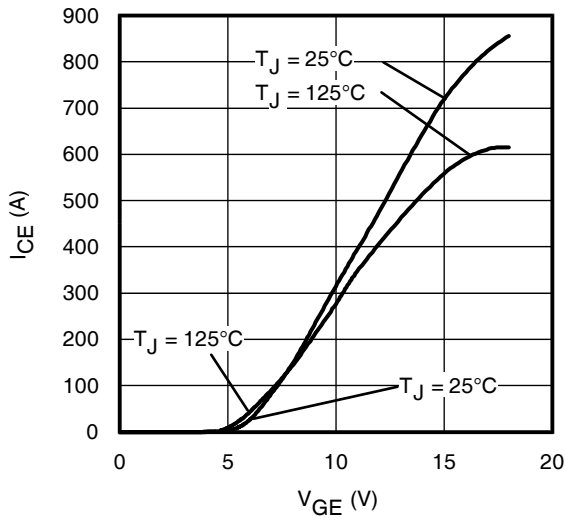

Fig. 7 - Typ. Transfer Characteristics
 $V_{CE} = 50V$; $t_p = 10\mu s$

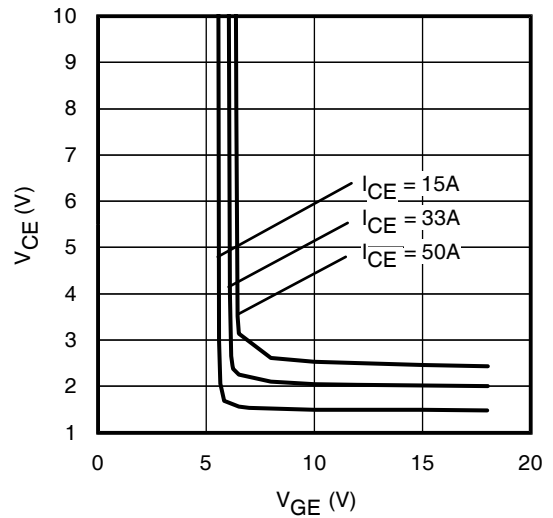

Fig. 8 - Typical V_{CE} vs. V_{GE}
 $T_J = 25^\circ C$

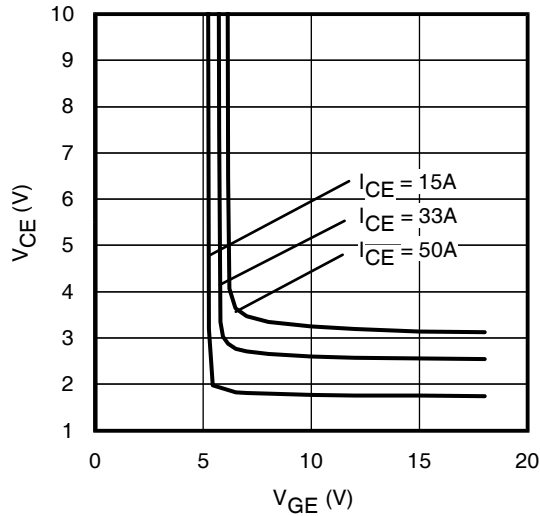

Fig. 9 - Typical V_{CE} vs. V_{GE}
 $T_J = 125^\circ C$

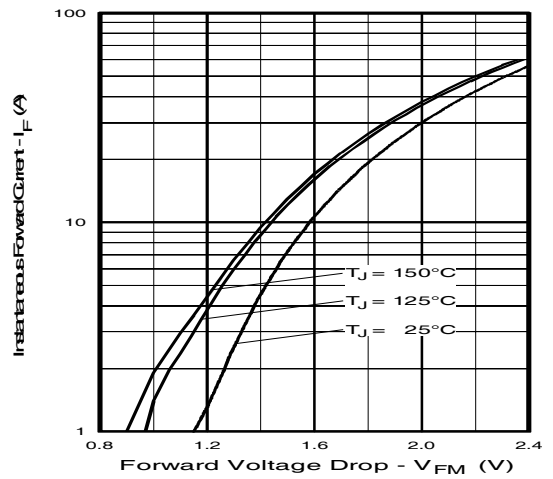

Fig. 10 - Typ. Diode Forward Characteristics
 $t_p = 80\mu s$

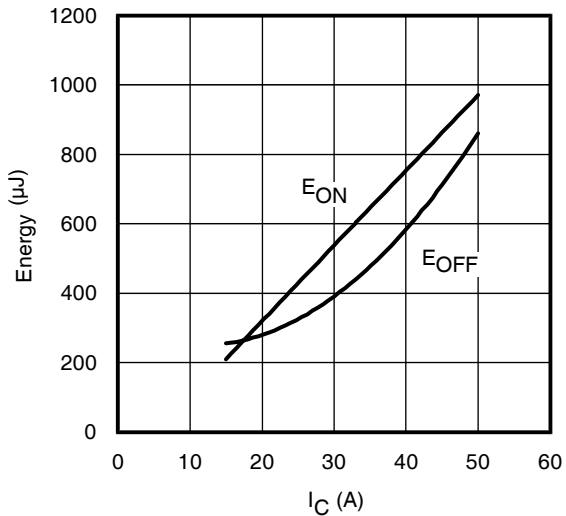

Fig. 11 - Typ. Energy Loss vs. I_C
 $T_J = 125^\circ C$; $L = 200\mu H$; $V_{CE} = 390V$; $R_G = 3.3\Omega$; $V_{GE} = 15V$.
Diode clamp used: 30ETH06 (See C.T.3)

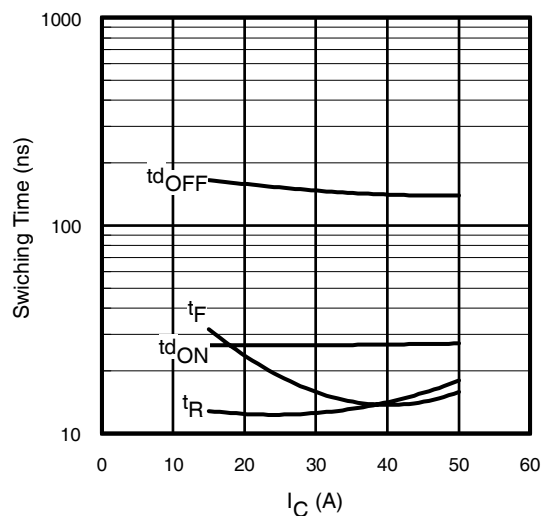

Fig. 12 - Typ. Switching Time vs. I_C
 $T_J = 125^\circ C$; $L = 200\mu H$; $V_{CE} = 390V$; $R_G = 3.3\Omega$; $V_{GE} = 15V$.
Diode clamp used: 30ETH06 (See C.T.3)

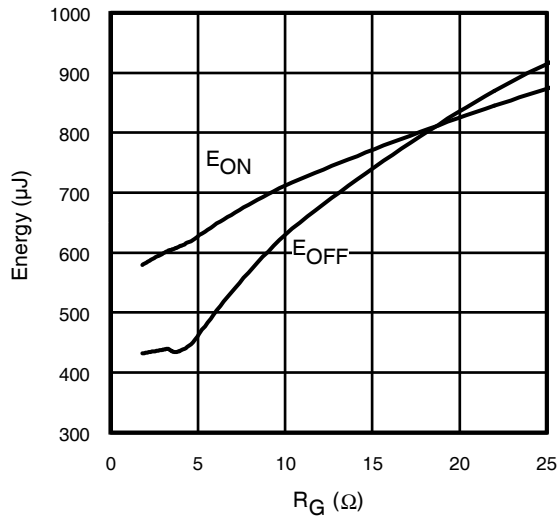

Fig. 13 - Typ. Energy Loss vs. R_G
 $T_J = 125^\circ\text{C}$; $L = 200\mu\text{H}$; $V_{CE} = 390\text{V}$; $I_{CE} = 33\text{A}$; $V_{GE} = 15\text{V}$
 Diode clamp used: 30ETH06 (See C.T.3)

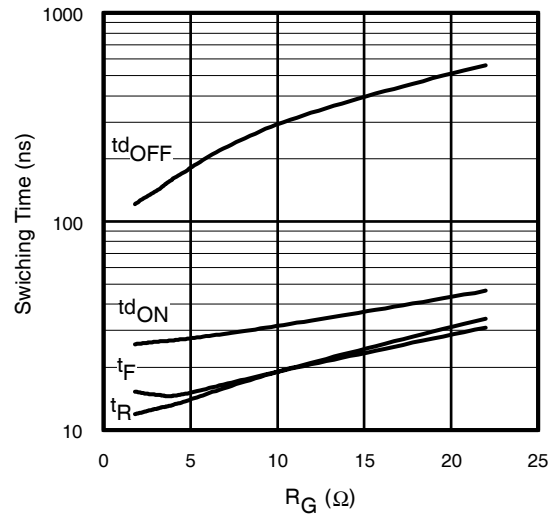
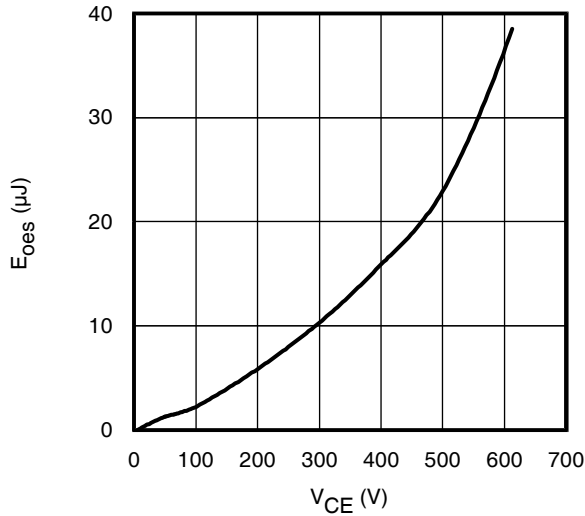

Fig. 14 - Typ. Switching Time vs. R_G
 $T_J = 125^\circ\text{C}$; $L = 200\mu\text{H}$; $V_{CE} = 390\text{V}$; $I_{CE} = 33\text{A}$; $V_{GE} = 15\text{V}$
 Diode clamp used: 30ETH06 (See C.T.3)



**Fig. 15- Typ. Output Capacitance
 Stored Energy vs. V_{CE}**

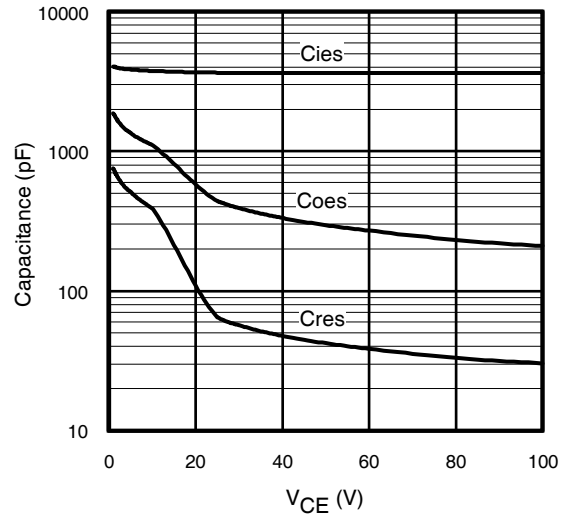

Fig. 16- Typ. Capacitance vs. V_{CE}
 $V_{GE} = 0\text{V}$; $f = 1\text{MHz}$

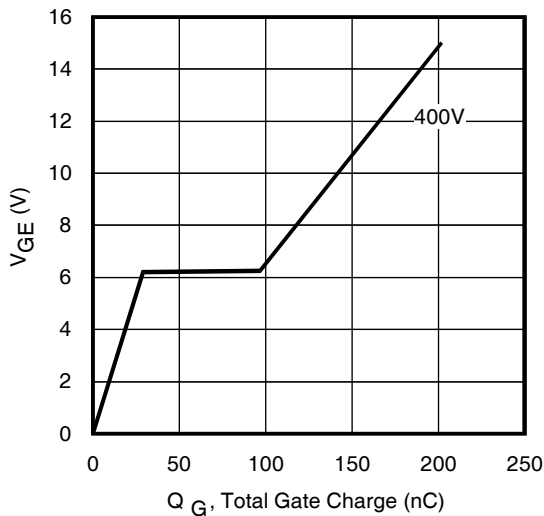
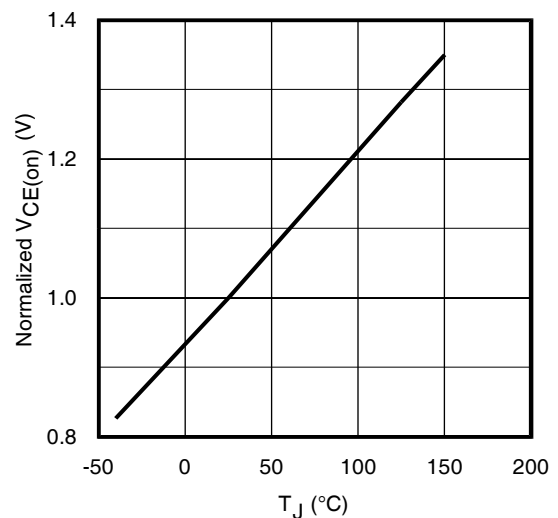

Fig. 17 - Typical Gate Charge vs. V_{GE}
 $I_{CE} = 33\text{A}$



**Fig. 18 - Normalized Typ. $V_{CE(on)}$
 vs. Junction Temperature**
 $I_C = 33\text{A}$, $V_{GE} = 15\text{V}$

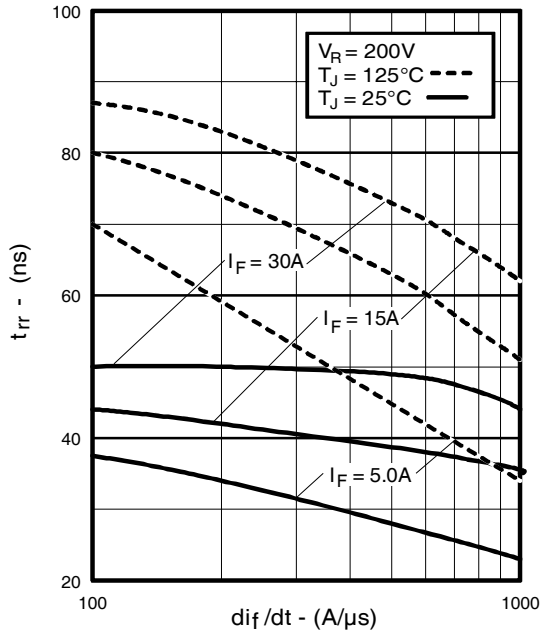

Fig. 19 - Typical Reverse Recovery vs. di_f/dt

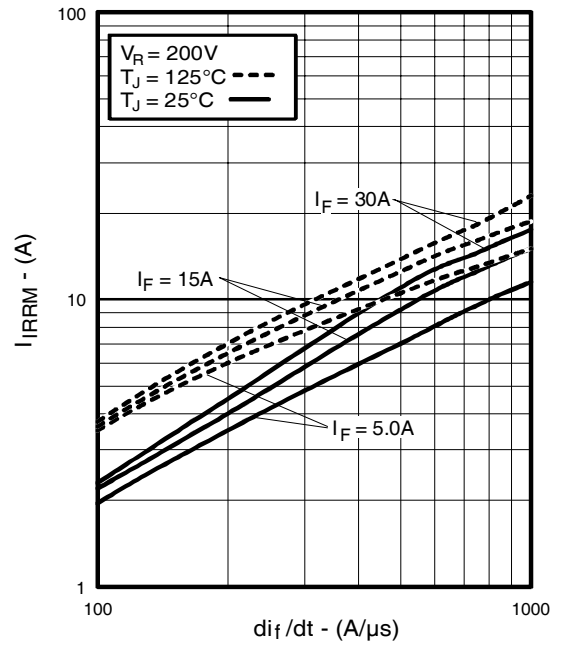

Fig. 20 - Typical Recovery Current vs. di_f/dt

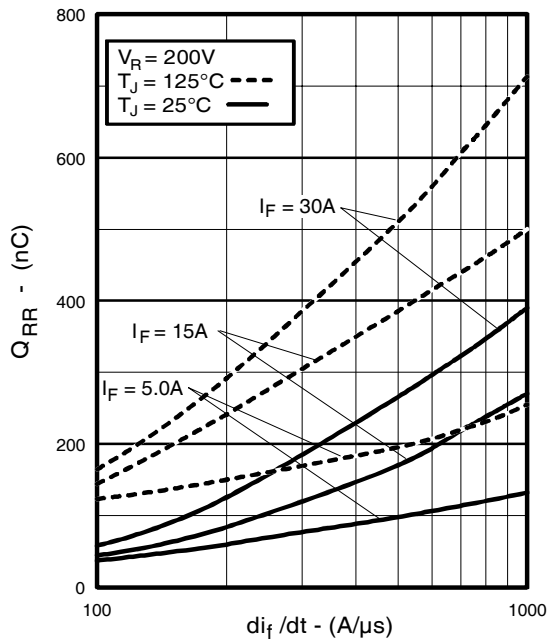

Fig. 21 - Typical Stored Charge vs. di_f/dt

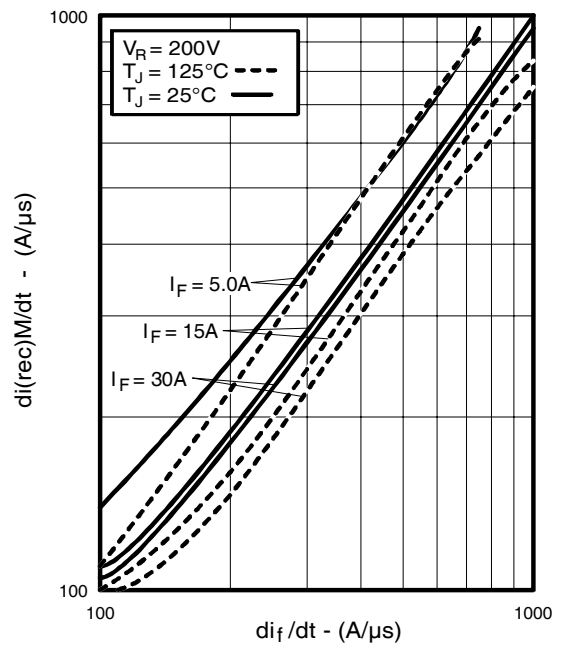

Fig. 22 - Typical $di_{(rec)M}/dt$ vs. di_f/dt

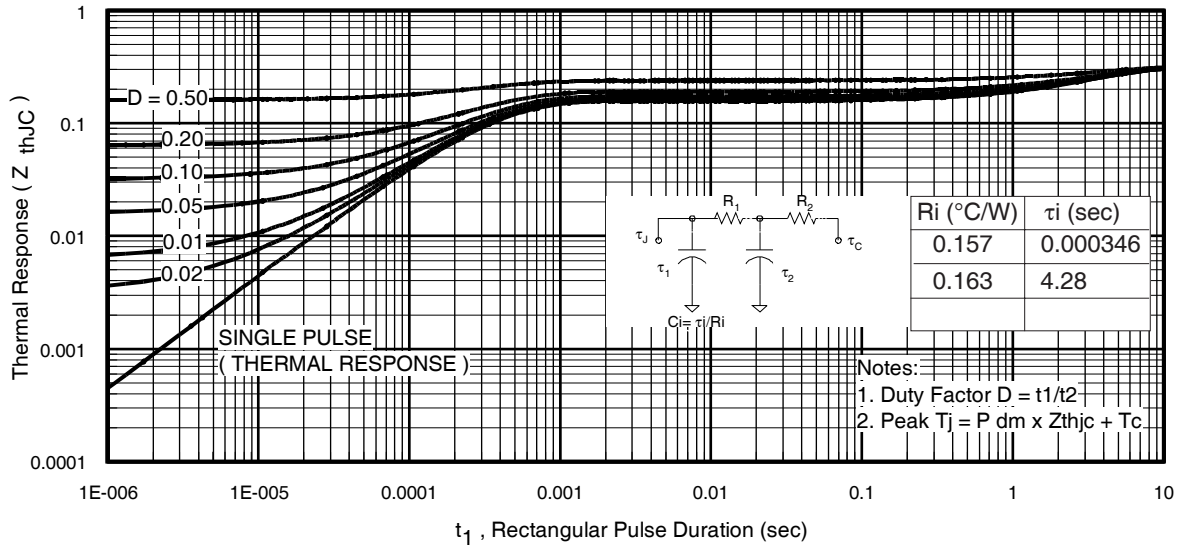

Fig 23. Maximum Transient Thermal Impedance, Junction-to-Case (IGBT)

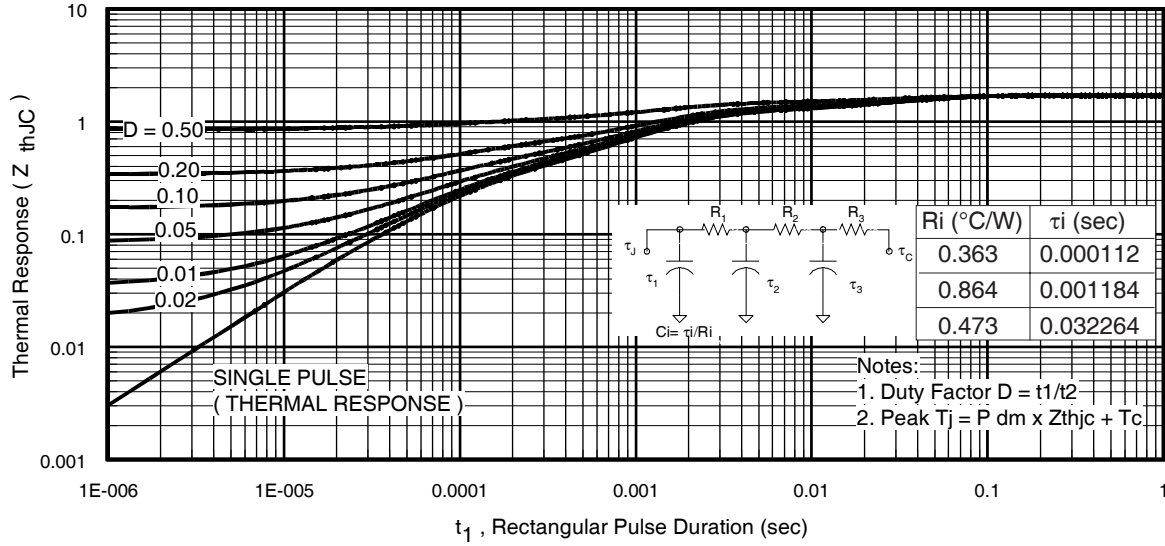

Fig. 24. Maximum Transient Thermal Impedance, Junction-to-Case (DIODE)

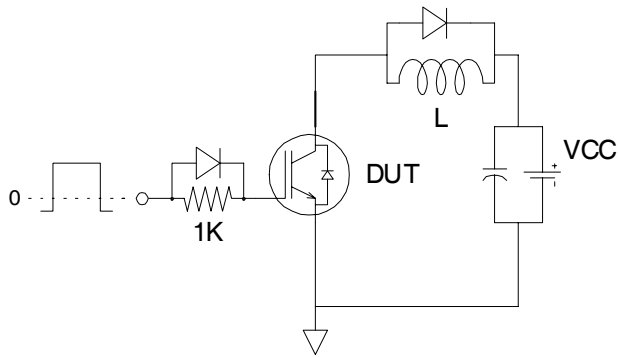

Fig.C.T.1 - Gate Charge Circuit (turn-off)

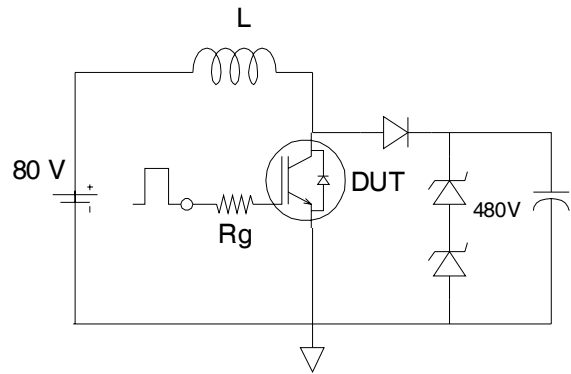

Fig.C.T.2 - RBSOA Circuit

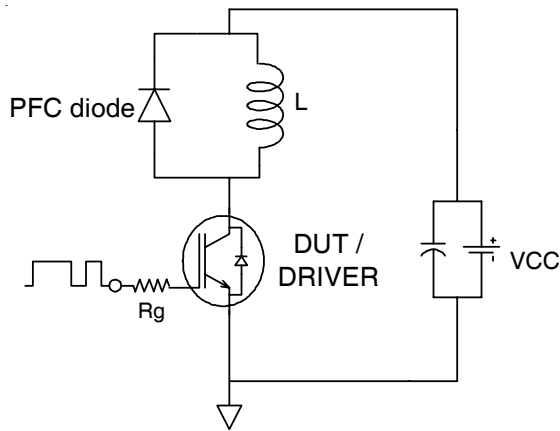

Fig.C.T.3 - Switching Loss Circuit

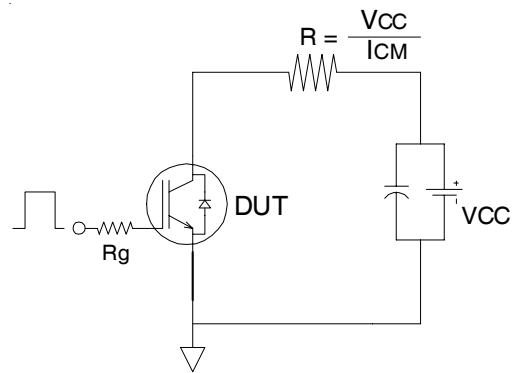

Fig.C.T.4 - Resistive Load Circuit

REVERSE RECOVERY CIRCUIT

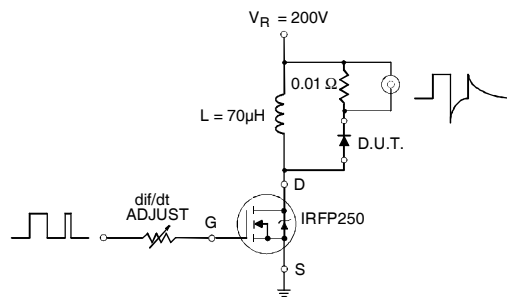

Fig. C.T.5 - Reverse Recovery Parameter Test Circuit

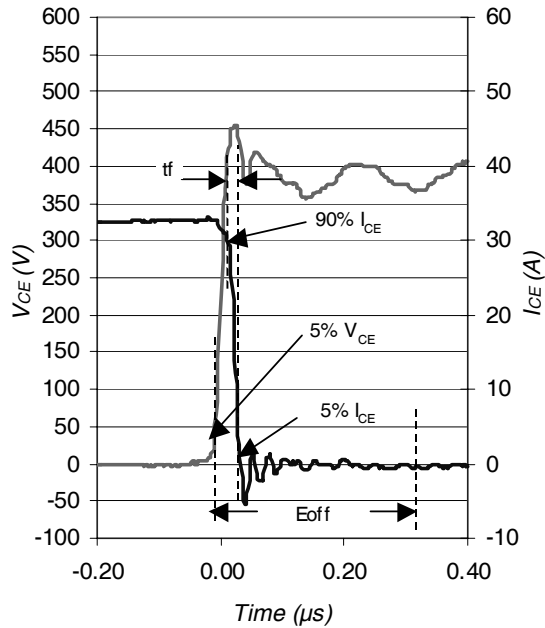

Fig. WF1 - Typ. Turn-off Loss Waveform
@ $T_J = 25^\circ\text{C}$ using Fig. CT.3

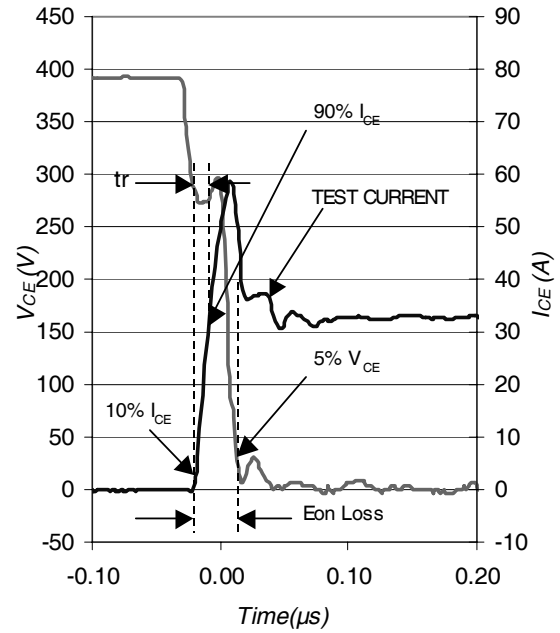
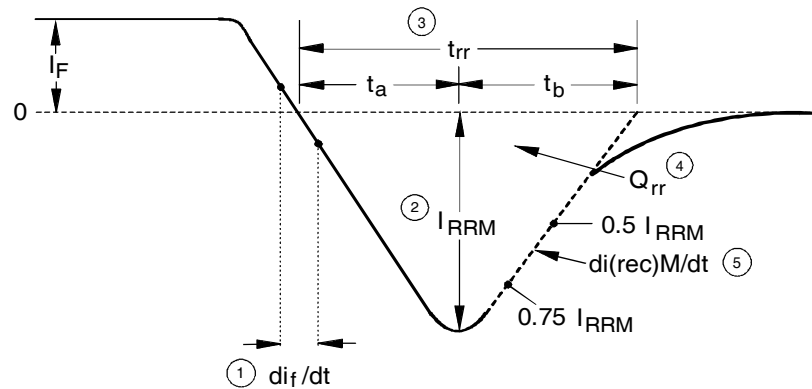

Fig. WF2 - Typ. Turn-on Loss Waveform
@ $T_J = 25^\circ\text{C}$ using Fig. CT.3



1. di_f/dt - Rate of change of current through zero crossing
2. I_{RRM} - Peak reverse recovery current
3. t_{rr} - Reverse recovery time measured from zero crossing point of negative going I_F to point where a line passing through $0.75 I_{RRM}$ and $0.50 I_{RRM}$ extrapolated to zero current

4. Q_{rr} - Area under curve defined by t_{rr} and I_{RRM}

$$Q_{rr} = \frac{t_{rr} \times I_{RRM}}{2}$$

5. $di_{(rec)M}/dt$ - Peak rate of change of current during t_b portion of t_{rr}

Fig. WF3 - Reverse Recovery Waveform and Definitions

TO-247AD Package Outline

Dimensions are shown in millimeters (inches)

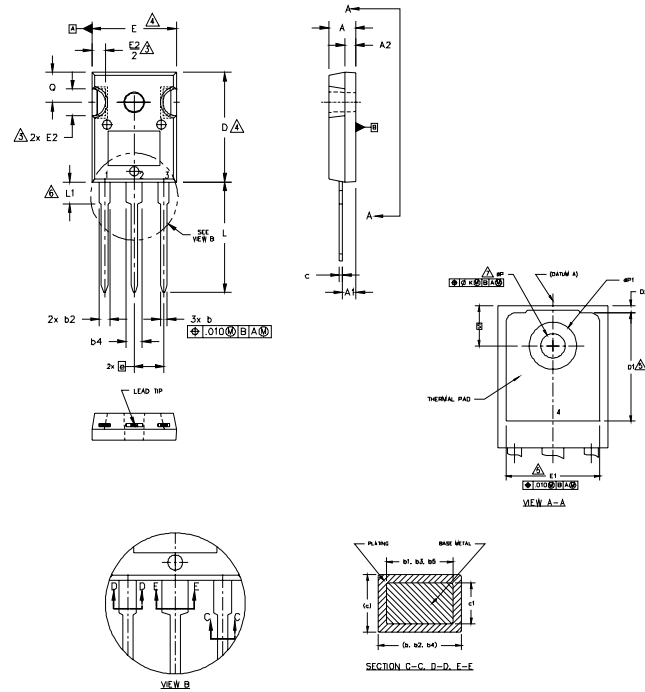

NOTES:

1. DIMENSIONING AND TOLERANCING AS PER ASME Y14.5M 1994.
2. DIMENSIONS ARE SHOWN IN INCHES.
3. CONTOUR OF SLOT OPTIONAL.
4. DIMENSION D & E DO NOT INCLUDE MOLD FLASH. MOLD FLASH SHALL NOT EXCEED .005" (0.127) PER SIDE. THESE DIMENSIONS ARE MEASURED AT THE OUTERMOST EXTREMES OF THE PLASTIC BODY.
5. THERMAL PAD CONTOUR OPTIONAL WITHIN DIMENSIONS D1 & E1.
6. LEAD FINISH UNCONTROLLED IN L1.
7. ØP1 TO HAVE A MAXIMUM DRAFT ANGLE OF 1.5 ° TO THE TOP OF THE PART WITH A MAXIMUM HOLE DIAMETER OF .154 INCH.
8. OUTLINE CONFORMS TO JEDEC OUTLINE TO-247AD.

SYMBOL	DIMENSIONS				NOTES
	INCHES		MILLIMETERS		
	MIN.	MAX.	MIN.	MAX.	
A	.183	.209	4.65	5.31	
A1	.087	.102	2.21	2.59	
A2	.059	.098	1.50	2.49	
b	.039	.055	0.99	1.40	
b1	.039	.053	0.99	1.35	
b2	.065	.094	1.65	2.39	
b3	.065	.092	1.65	2.34	
b4	.102	.135	2.59	3.43	
b5	.102	.133	2.59	3.38	
c	.015	.035	0.38	0.89	
c1	.015	.033	0.38	0.84	
D	.776	.815	19.71	20.70	4
D1	.515	-	13.08	-	5
D2	.020	.053	0.51	1.35	
E	.602	.625	15.29	15.87	4
E1	.530	-	13.46	-	
E2	.178	.216	4.52	5.49	
e	.215 BSC		5.46 BSC		
Øk	.010		0.25		
L	.780	.827	19.57	21.00	
L1	.146	.169	3.71	4.29	
ØP1	.140	.144	3.56	3.66	
ØP2	-	.291	-	7.39	
Q	.209	.224	5.31	5.69	
S	.217 BSC		5.51 BSC		

LEAD ASSIGNMENTS

HEXFET

- 1.- GATE
- 2.- DRAIN
- 3.- SOURCE
- 4.- DRAIN

IGBTs, CoPACK

- 1.- GATE
- 2.- COLLECTOR
- 3.- EMITTER
- 4.- COLLECTOR

DIODES

- 1.- ANODE/OPEN
- 2.- CATHODE
- 3.- ANODE

TO-247AD Part Marking Information

EXAMPLE: THIS IS AN IRGP30B120KD-E
WITH ASSEMBLY
LOT CODE 5657
ASSEMBLED ON WW 35, 2000
IN THE ASSEMBLY LINE "H"

Note: "P" in assembly line position
indicates "Lead-Free"

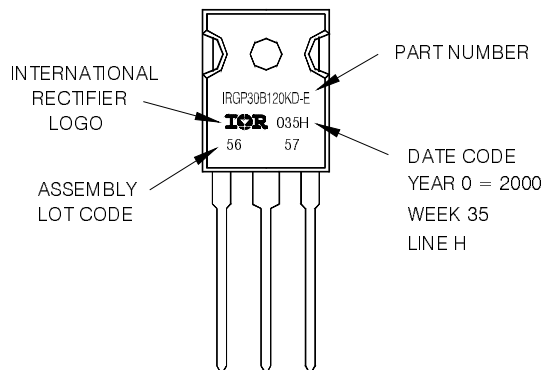

TO-247AD package is not recommended for Surface Mount Application.

Note: For the most current drawing please refer to IR website at <http://www.irf.com/package/>

Data and specifications subject to change without notice.
This product has been designed and qualified for Industrial market.
Qualification Standards can be found on IR's Web site.