



Chipsmall Limited consists of a professional team with an average of over 10 year of expertise in the distribution of electronic components. Based in Hongkong, we have already established firm and mutual-benefit business relationships with customers from,Europe,America and south Asia,supplying obsolete and hard-to-find components to meet their specific needs.

With the principle of “Quality Parts,Customers Priority,Honest Operation,and Considerate Service”,our business mainly focus on the distribution of electronic components. Line cards we deal with include Microchip,ALPS,ROHM,Xilinx,Pulse,ON,Everlight and Freescale. Main products comprise IC,Modules,Potentiometer,IC Socket,Relay,Connector.Our parts cover such applications as commercial,industrial, and automotives areas.

We are looking forward to setting up business relationship with you and hope to provide you with the best service and solution. Let us make a better world for our industry!



Contact us

Tel: +86-755-8981 8866 Fax: +86-755-8427 6832

Email & Skype: info@chipsmall.com Web: www.chipsmall.com

Address: A1208, Overseas Decoration Building, #122 Zhenhua RD., Futian, Shenzhen, China



DirectFET™ N-Channel Power MOSFET

Application

- Brushed Motor drive applications
- BLDC Motor drive applications
- Battery powered circuits
- Half-bridge and full-bridge topologies
- Synchronous rectifier applications
- Resonant mode power supplies
- OR-ing and redundant power switches
- DC/DC and AC/DC converters
- DC/AC Inverters

Benefits

- Optimized for Logic Level Drive
- Improved Gate, Avalanche and Dynamic dv/dt Ruggedness
- Fully Characterized Capacitance and Avalanche SOA
- Enhanced body diode dv/dt and di/dt Capability
- Lead-Free, RoHS Compliant

V_{DSS}	40V
R_{DS(on)} typ. max @ V_{GS} = 10V	0.34mΩ
	0.45mΩ
R_{DS(on)} typ. max @ V_{GS} = 4.5V	0.52mΩ
	0.70mΩ
I_D (Package Limited)	375A①

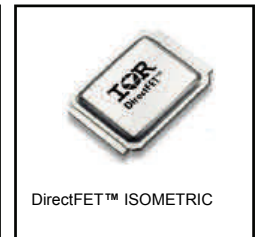
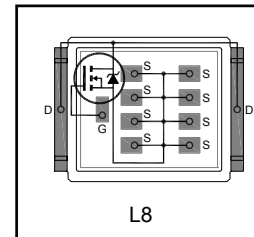

Base part number	Package Type	Standard Pack		Orderable Part Number
		Form	Quantity	
IRL7472L1PbF	Direct FET Large Can (L8)	Tape and Reel	4000	IRL7472L1TRPbF

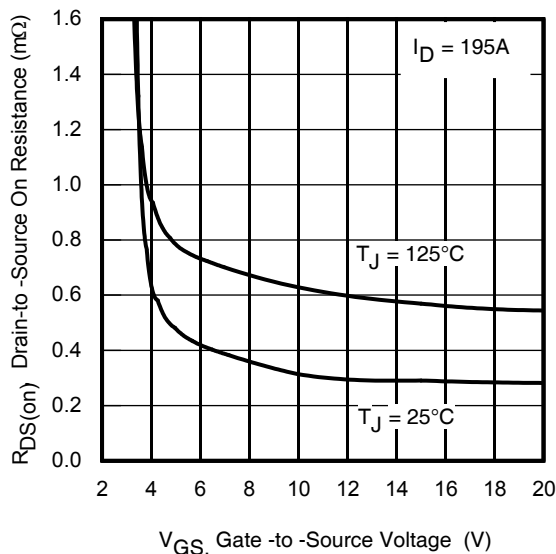

Fig 1. Typical On-Resistance vs. Gate Voltage

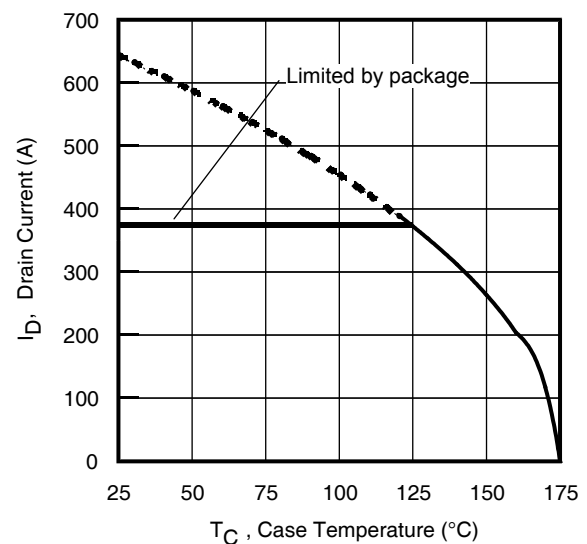

Fig 2. Maximum Drain Current vs. Case Temperature

Absolute Maximum Ratings

Symbol	Parameter	Max.	Units
$I_D @ T_C = 25^\circ\text{C}$	Continuous Drain Current, $V_{GS} @ 10\text{V}$ (Silicon Limited) ①	645⑩	A
$I_D @ T_C = 100^\circ\text{C}$	Continuous Drain Current, $V_{GS} @ 10\text{V}$ (Silicon Limited) ①	456	
$I_D @ T_A = 25^\circ\text{C}$	Continuous Drain Current, $V_{GS} @ 10\text{V}$ (Silicon Limited) ①	68	
$I_D @ T_C = 25^\circ\text{C}$	Continuous Drain Current, $V_{GS} @ 10\text{V}$ (Package Limited)④	375⑪	
I_{DM}	Pulsed Drain Current ②	1500	A
$P_D @ T_C = 25^\circ\text{C}$	Maximum Power Dissipation	341	W
$P_D @ T_A = 25^\circ\text{C}$	Maximum Power Dissipation	3.8	
	Linear Derating Factor	0.025	W/°C
V_{GS}	Gate-to-Source Voltage	± 20	V
T_J T_{STG}	Operating Junction and Storage Temperature Range	-55 to + 175	°C

Avalanche Characteristics

E_{AS} (Thermally limited)	Single Pulse Avalanche Energy ③	308	mJ
E_{AS} (Thermally limited)	Single Pulse Avalanche Energy ⑨	765	
I_{AR}	Avalanche Current ②	See Fig. 15, 16, 23a, 23b	A
E_{AR}	Repetitive Avalanche Energy ②		mJ

Thermal Resistance

Symbol	Parameter	Typ.	Max.	Units
$R_{\theta JA}$	Junction-to-Ambient ①	—	40	°C/W
$R_{\theta JA}$	Junction-to-Ambient ③	12.5	—	
$R_{\theta JA}$	Junction-to-Ambient ②	20	—	
$R_{\theta JC}$	Junction-to-Case ④⑧	—	0.44	
$R_{\theta JA-PCB}$	Junction-to-PCB Mounted	1.0	—	

Static @ $T_J = 25^\circ\text{C}$ (unless otherwise specified)

Symbol	Parameter	Min.	Typ.	Max.	Units	Conditions
$V_{(BR)DSS}$	Drain-to-Source Breakdown Voltage	40	—	—	V	$V_{GS} = 0\text{V}, I_D = 250\mu\text{A}$
$\Delta V_{(BR)DSS}/\Delta T_J$	Breakdown Voltage Temp. Coefficient	—	30	—	mV/°C	Reference to $25^\circ\text{C}, I_D = 5.0\text{mA}$ ②
$R_{DS(on)}$	Static Drain-to-Source On-Resistance	—	0.34	0.45	mΩ	$V_{GS} = 10\text{V}, I_D = 195\text{A}$
		—	0.52	0.70		$V_{GS} = 4.5\text{V}, I_D = 98\text{A}$
$V_{GS(th)}$	Gate Threshold Voltage	1.0	1.7	2.5	V	$V_{DS} = V_{GS}, I_D = 250\mu\text{A}$
I_{DSS}	Drain-to-Source Leakage Current	—	—	1.0	μA	$V_{DS} = 40\text{V}, V_{GS} = 0\text{V}$
		—	—	150		$V_{DS} = 40\text{V}, V_{GS} = 0\text{V}, T_J = 125^\circ\text{C}$
I_{GSS}	Gate-to-Source Forward Leakage	—	—	100	nA	$V_{GS} = 20\text{V}$
	Gate-to-Source Reverse Leakage	—	—	-100		$V_{GS} = -20\text{V}$
R_G	Internal Gate Resistance	—	1.0	—	Ω	

Notes:

- ① Mounted on minimum footprint full size board with metalized back and with small clip heatsink.
- ② Used double sided cooling , mounting pad with large heatsink.
- ③ TC measured with thermocouple mounted to top (Drain) of part.



① Surface mounted on 1 in. square Cu board (still air).

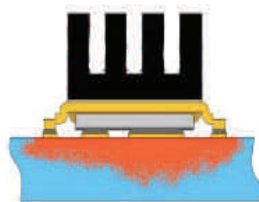

② Mounted to a PCB with small clip heatsink (still air)

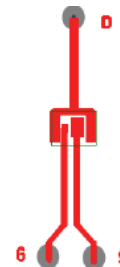

③ Mounted on minimum footprint full size board with metalized back and with small clip heatsink (still air)

Dynamic @ $T_J = 25^\circ\text{C}$ (unless otherwise specified)

Symbol	Parameter	Min.	Typ.	Max.	Units	Conditions
g_{fs}	Forward Transconductance	232	—	—	S	$V_{DS} = 10\text{V}$, $I_D = 195\text{A}$
Q_g	Total Gate Charge	—	220	330	nC	$I_D = 195\text{A}$
Q_{gs}	Gate-to-Source Charge	—	95	—		$V_{DS} = 20\text{V}$
Q_{gd}	Gate-to-Drain ("Miller") Charge	—	87	—		$V_{GS} = 4.5\text{V}$ ⑤
Q_{sync}	Total Gate Charge Sync. ($Q_g - Q_{gd}$)	—	133	—		$I_D = 195\text{A}$, $V_{DS} = 0\text{V}$, $V_{GS} = 4.5\text{V}$
$t_{d(on)}$	Turn-On Delay Time	—	68	—	ns	$V_{DD} = 20\text{V}$
t_r	Rise Time	—	176	—		$I_D = 30\text{A}$
$t_{d(off)}$	Turn-Off Delay Time	—	174	—		$R_G = 2.7\Omega$
t_f	Fall Time	—	137	—		$V_{GS} = 4.5\text{V}$ ⑤
C_{iss}	Input Capacitance	—	20082	—	pF	$V_{GS} = 0\text{V}$
C_{oss}	Output Capacitance	—	2436	—		$V_{DS} = 25\text{V}$
C_{rss}	Reverse Transfer Capacitance	—	1594	—		$f = 10\text{kHz}$
C_{oss} eff. (ER)	Effective Output Capacitance (Energy Related)	—	2855	—		$V_{GS} = 0\text{V}$, $V_{DS} = 0\text{V}$ to 32V ⑦
C_{oss} eff. (TR)	Effective Output Capacitance (Time Related)	—	3544	—		$V_{GS} = 0\text{V}$, $V_{DS} = 0\text{V}$ to 32V ⑥

Diode Characteristics

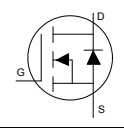
Symbol	Parameter	Min.	Typ.	Max.	Units	Conditions
I_S	Continuous Source Current (Body Diode)	—	—	341 ①	A	MOSFET symbol showing the integral reverse p-n junction diode. 
I_{SM}	Pulsed Source Current (Body Diode) ②	—	—	1500		
V_{SD}	Diode Forward Voltage	—	—	1.2	V	$T_J = 25^\circ\text{C}$, $I_S = 195\text{A}$, $V_{GS} = 0\text{V}$ ⑤
dv/dt	Peak Diode Recovery ④	—	1.3	—	V/ns	$T_J = 175^\circ\text{C}$, $I_S = 195\text{A}$, $V_{DS} = 40\text{V}$
t_{rr}	Reverse Recovery Time	—	57	—	ns	$T_J = 25^\circ\text{C}$ $V_R = 34\text{V}$,
		—	58	—		$T_J = 125^\circ\text{C}$ $I_F = 195\text{A}$
Q_{rr}	Reverse Recovery Charge	—	103	—	nC	$T_J = 25^\circ\text{C}$ $di/dt = 100\text{A}/\mu\text{s}$ ⑤
		—	114	—		$T_J = 125^\circ\text{C}$
I_{RRM}	Reverse Recovery Current	—	3.1	—	A	$T_J = 25^\circ\text{C}$

Notes:

- ① Package limit current based on source connection technology
- ② Repetitive rating; pulse width limited by max. junction temperature.
- ③ Limited by T_{Jmax} , starting $T_J = 25^\circ\text{C}$, $L = 0.016\text{mH}$, $R_G = 50\Omega$, $I_{AS} = 195\text{A}$, $V_{GS} = 10\text{V}$.
- ④ $I_{SD} \leq 195\text{A}$, $di/dt \leq 984\text{A}/\mu\text{s}$, $V_{DD} \leq V_{(BR)DSS}$, $T_J \leq 175^\circ\text{C}$.
- ⑤ Pulse width $\leq 400\mu\text{s}$; duty cycle $\leq 2\%$.
- ⑥ C_{oss} eff. (TR) is a fixed capacitance that gives the same charging time as C_{oss} while V_{DS} is rising from 0 to 80% V_{DSS} .
- ⑦ C_{oss} eff. (ER) is a fixed capacitance that gives the same energy as C_{oss} while V_{DS} is rising from 0 to 80% V_{DSS} .
- ⑧ R_θ is measured at T_J approximately 90°C .
- ⑨ Limited by T_{Jmax} , starting $T_J = 25^\circ\text{C}$, $L = 1.0\text{mH}$, $R_G = 50\Omega$, $I_{AS} = 39\text{A}$, $V_{GS} = 10\text{V}$.
- ⑩ Silicon limit current based on maximum allowable junction temperature T_{Jmax} .

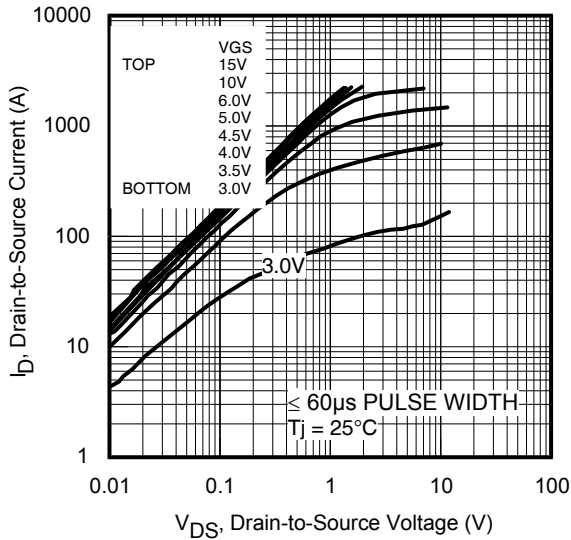
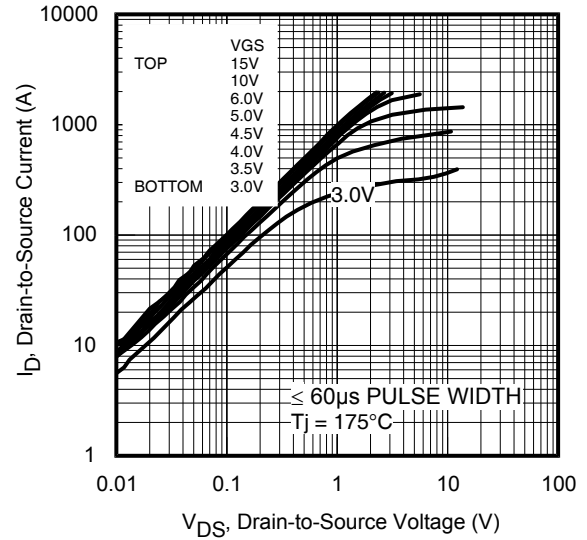
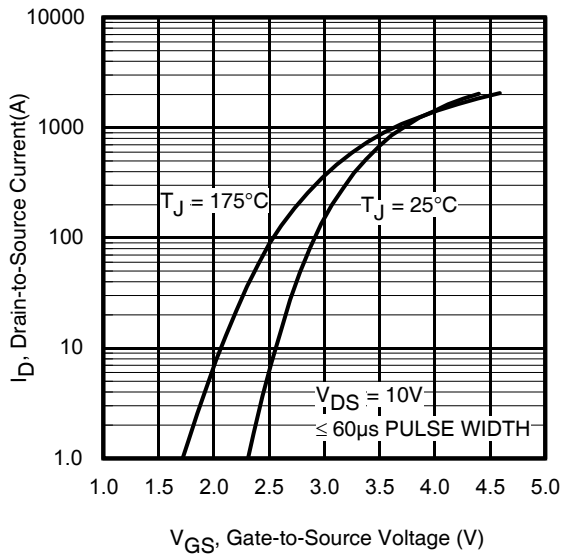
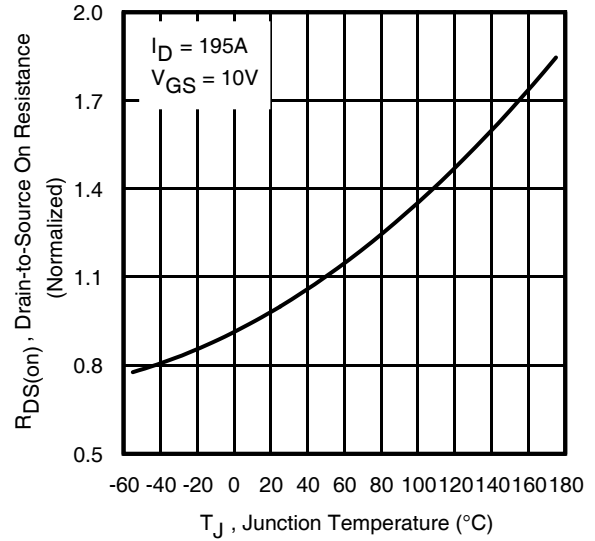
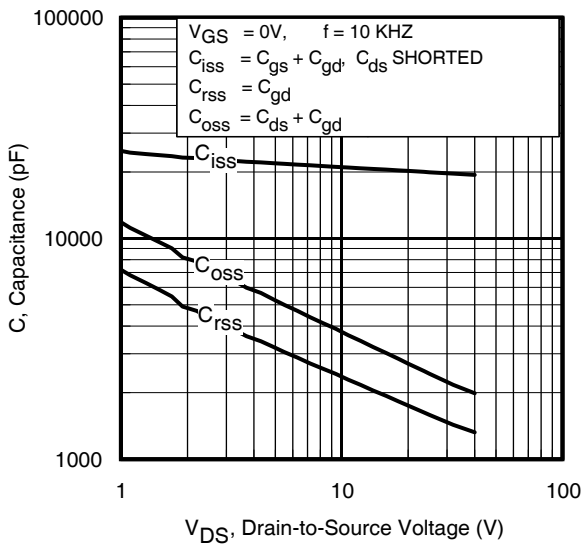
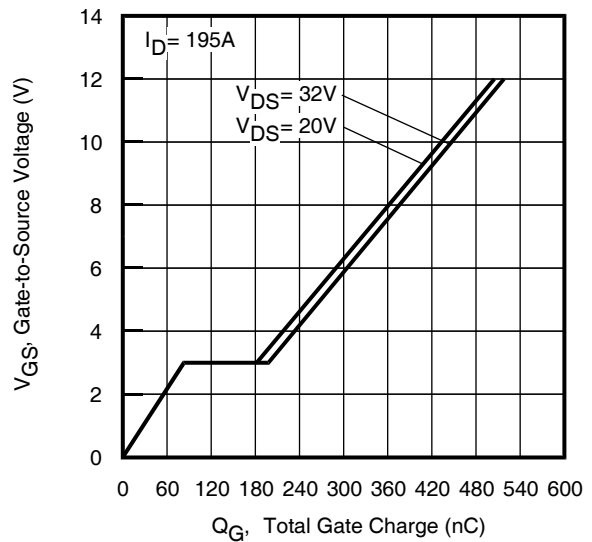
Fig 3. Typical Output Characteristics

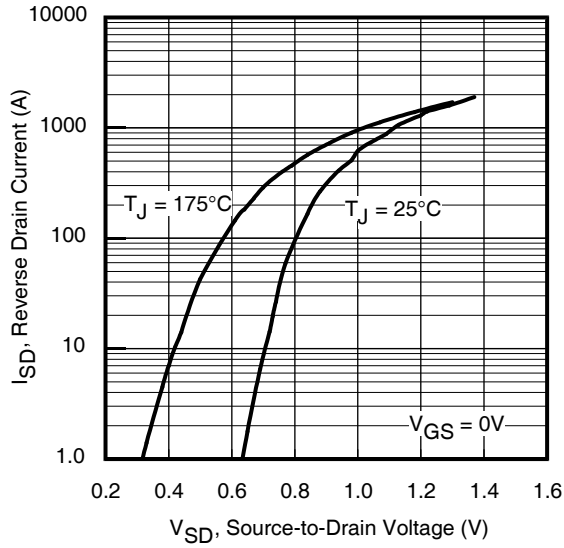
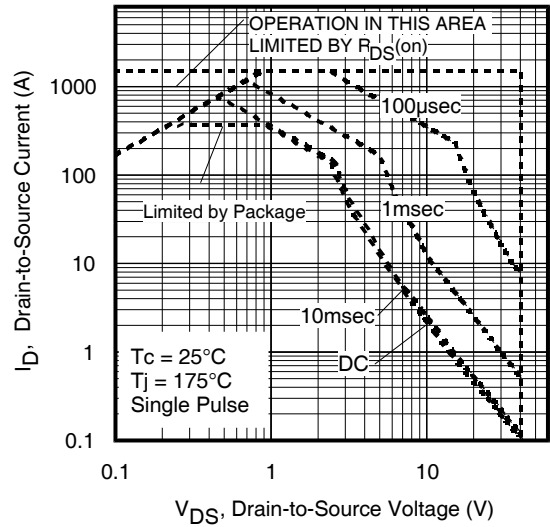
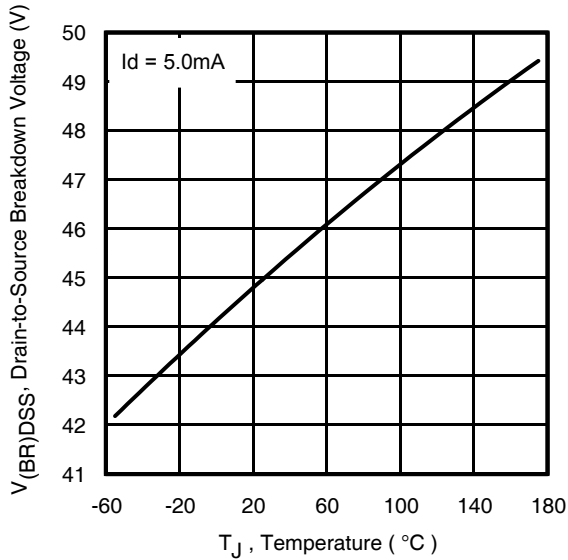
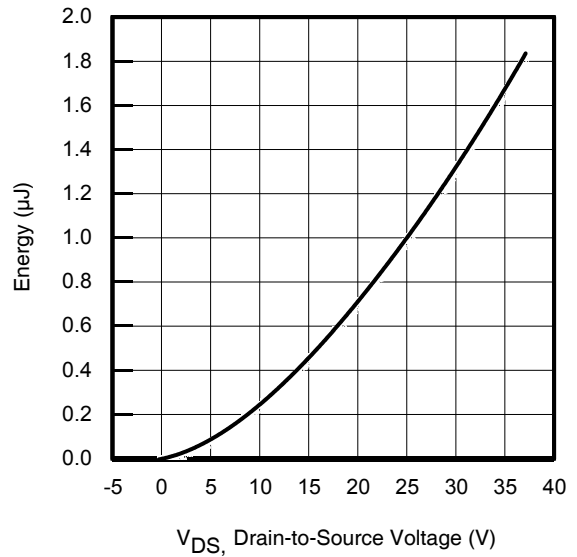
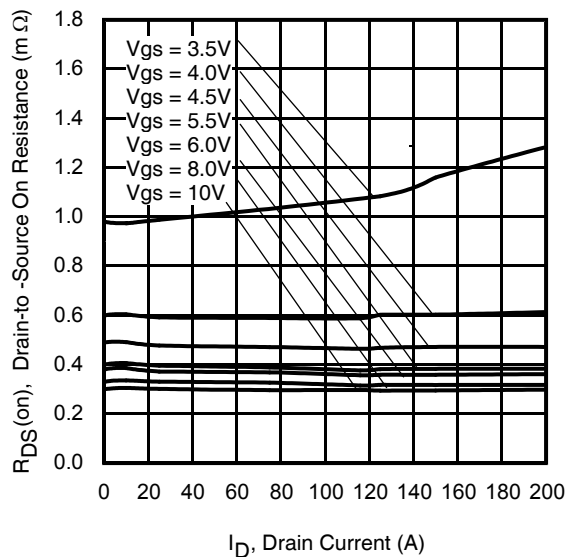
Fig 4. Typical Output Characteristics

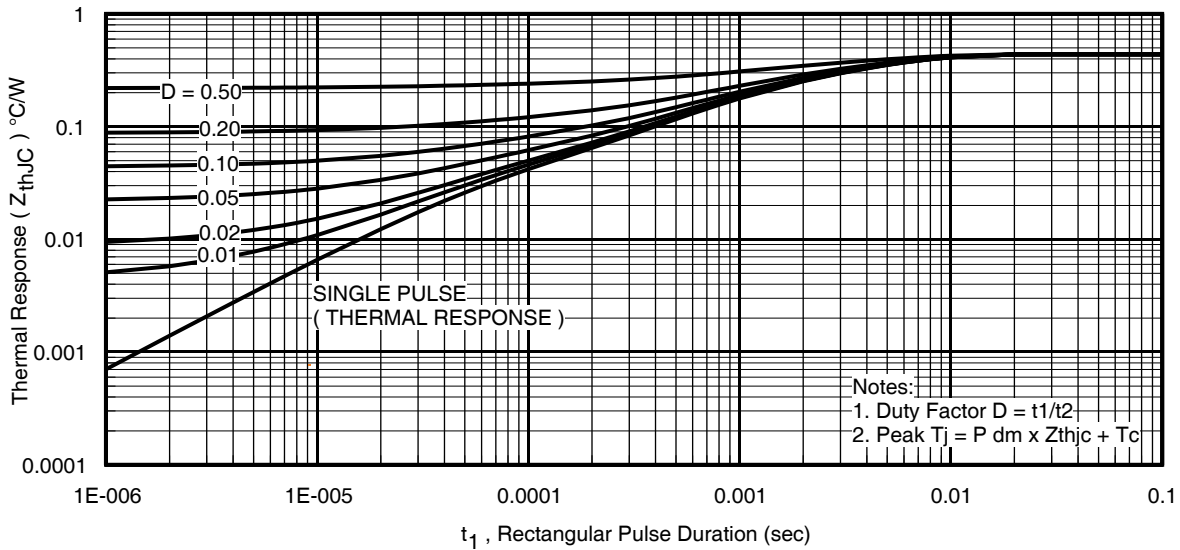
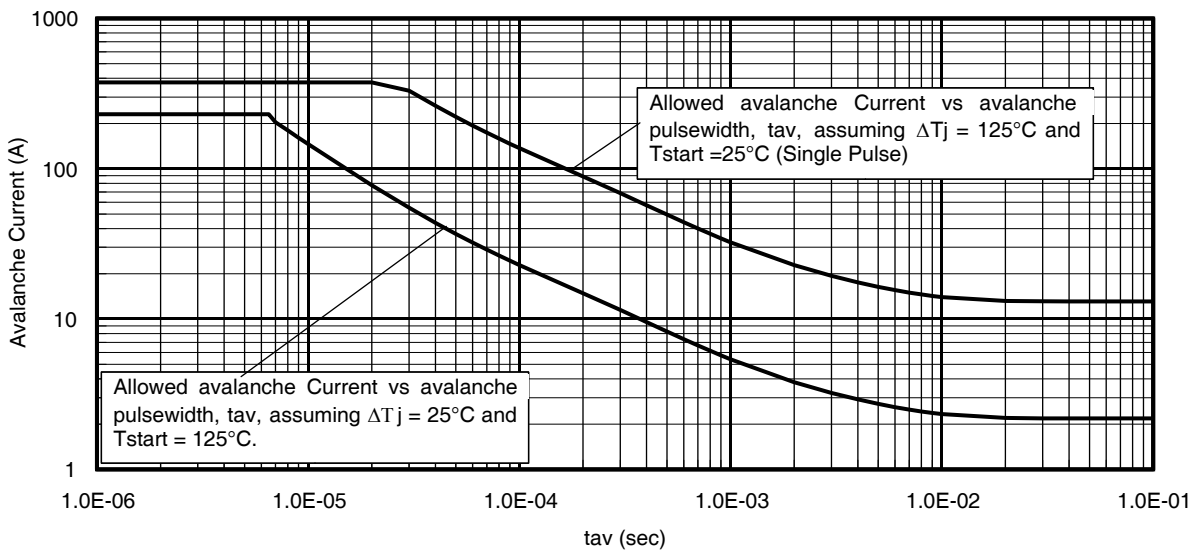
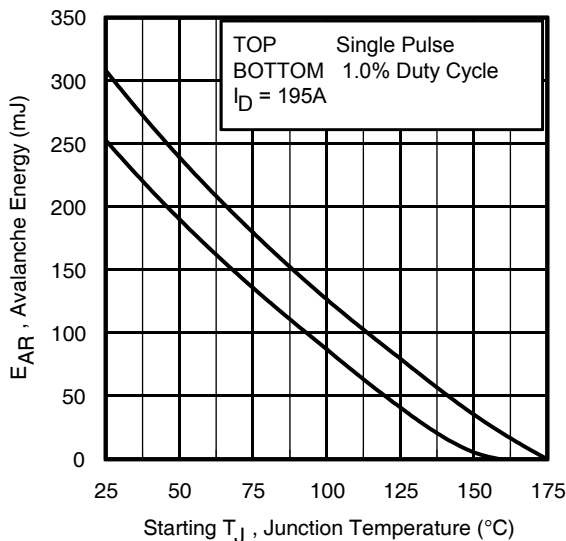
Fig 5. Typical Transfer Characteristics

Fig 6. Normalized On-Resistance vs. Temperature

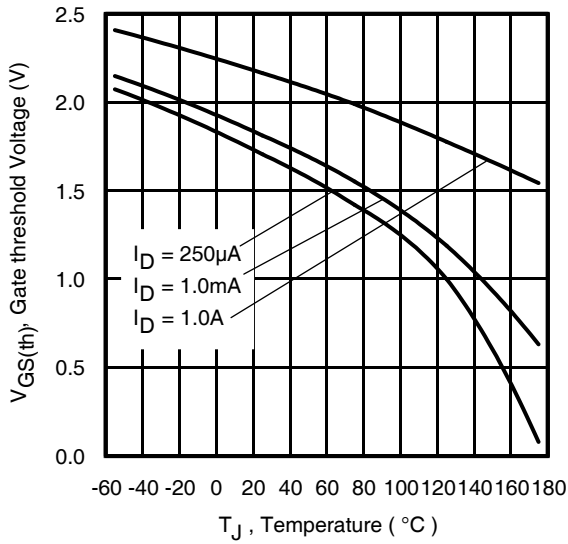
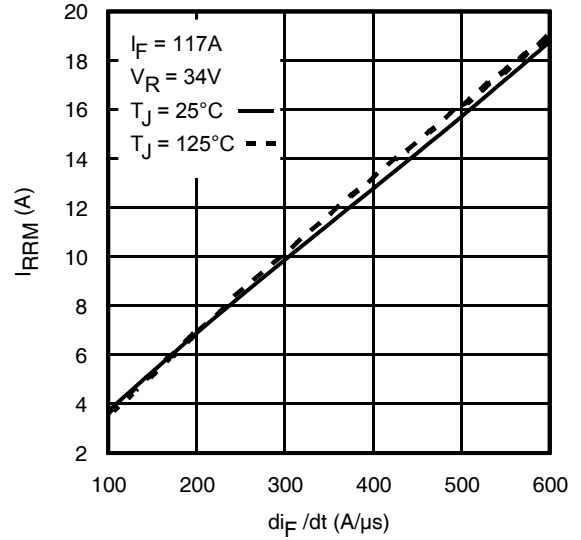
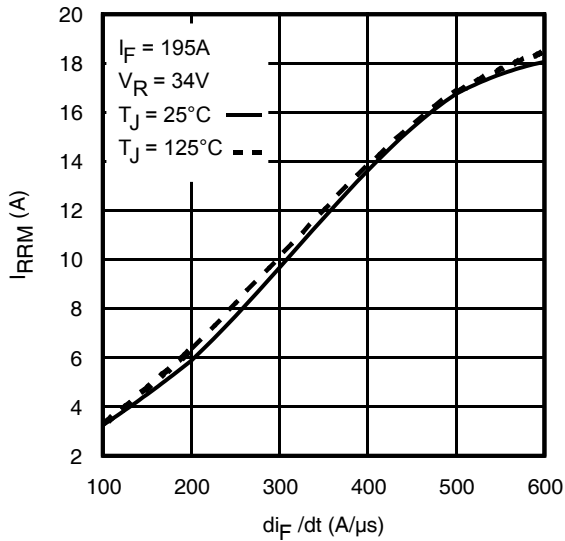
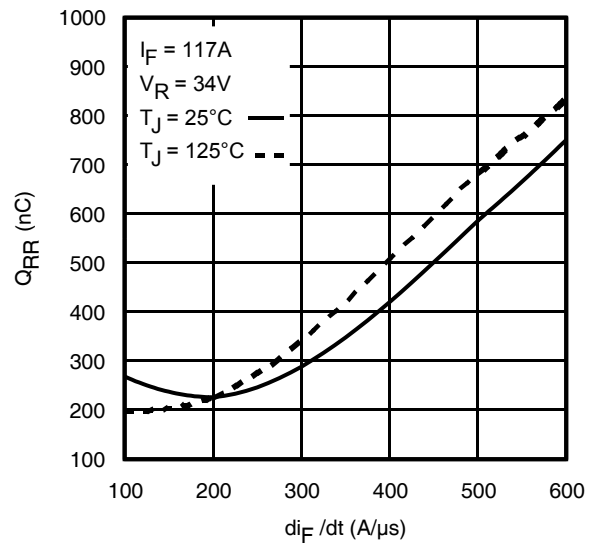
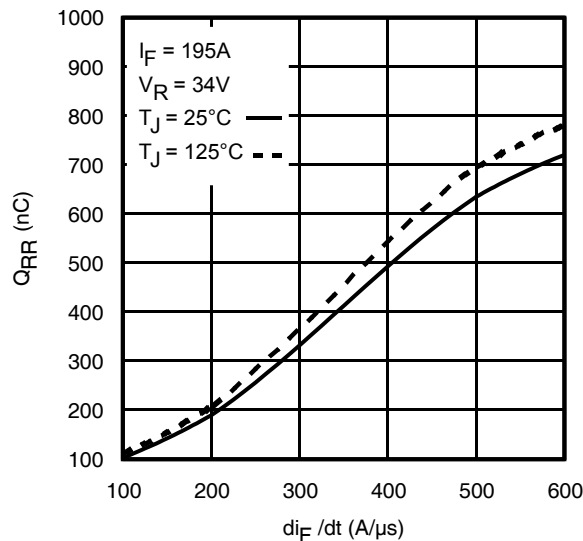
Fig 7. Typical Capacitance vs. Drain-to-Source Voltage

Fig 8. Typical Gate Charge vs. Gate-to-Source Voltage

Fig 9. Typical Source-Drain Diode Forward Voltage

Fig 10. Maximum Safe Operating Area

Fig 11. Drain-to-Source Breakdown Voltage

Fig 12. Typical C_{oss} Stored Energy

Fig 13. Typical On-Resistance vs. Drain Current

Fig 14. Maximum Effective Transient Thermal Impedance, Junction-to-Case

Fig 15. Avalanche Current vs. Pulse Width

Fig 16. Maximum Avalanche Energy vs. Temperature
**Notes on Repetitive Avalanche Curves , Figures 15, 16:
(For further info, see AN-1005)**

1. Avalanche failures assumption:
Purely a thermal phenomenon and failure occurs at a temperature far in excess of T_{jmax} . This is validated for every part type.
2. Safe operation in Avalanche is allowed as long as T_{jmax} is not exceeded.
3. Equation below based on circuit and waveforms shown in Figures 23a, 23b.
4. $P_{D(ave)}$ = Average power dissipation per single avalanche pulse.
5. BV = Rated breakdown voltage (1.3 factor accounts for voltage increase during avalanche).
6. I_{av} = Allowable avalanche current.
7. ΔT = Allowable rise in junction temperature, not to exceed T_{jmax} (assumed as 25°C in Figure 14, 15).
 t_{av} = Average time in avalanche.
 D = Duty cycle in avalanche = $t_{av} \cdot f$
 $Z_{thJC}(D, t_{av})$ = Transient thermal resistance, see Figures 13)
 $P_{D(ave)} = 1/2 (1.3 \cdot BV \cdot I_{av}) = \Delta T / Z_{thJC}$
 $I_{av} = 2\Delta T / [1.3 \cdot BV \cdot Z_{th}]$
 $E_{AS(AR)} = P_{D(ave)} \cdot t_{av}$

Fig 17. Threshold Voltage vs. Temperature

Fig 18. Typical Recovery Current vs. dif/dt

Fig 19. Typical Recovery Current vs. dif/dt

Fig 20. Typical Stored Charge vs. dif/dt

Fig 21. Typical Stored Charge vs. dif/dt

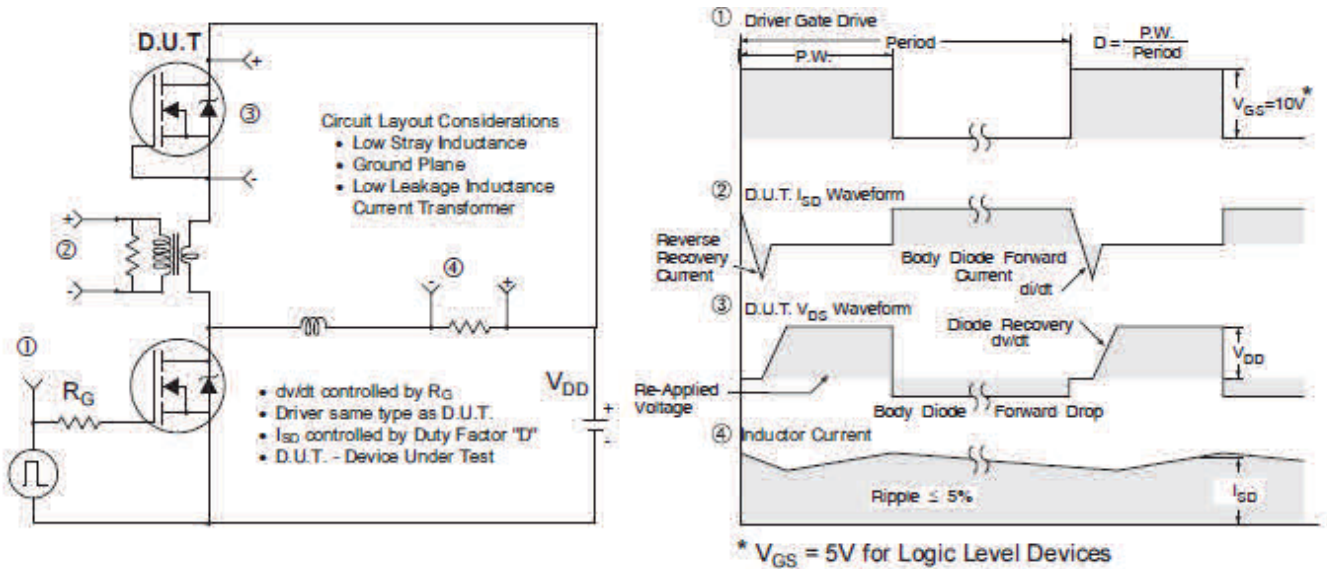

Fig 22. Peak Diode Recovery dv/dt Test Circuit for N-Channel HEXFET® Power MOSFETs

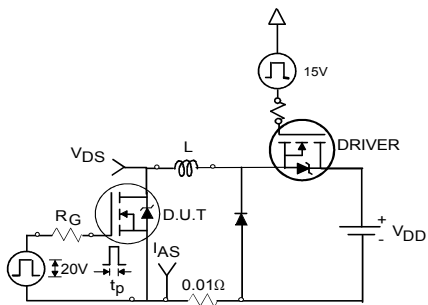

Fig 23a. Unclamped Inductive Test Circuit

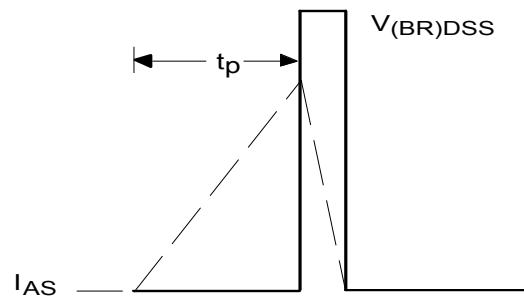

Fig 23b. Unclamped Inductive Waveforms

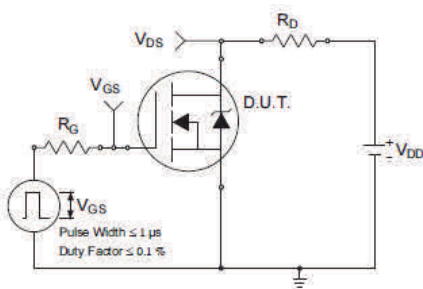

Fig 24a. Switching Time Test Circuit

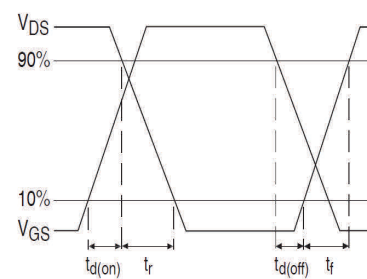

Fig 24b. Switching Time Waveforms

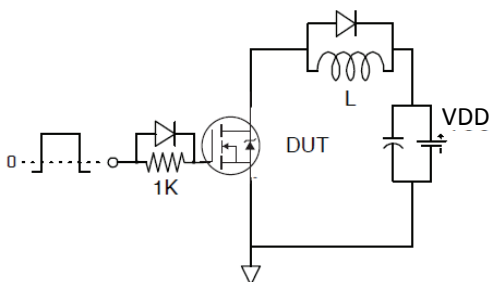

Fig 25a. Gate Charge Test Circuit

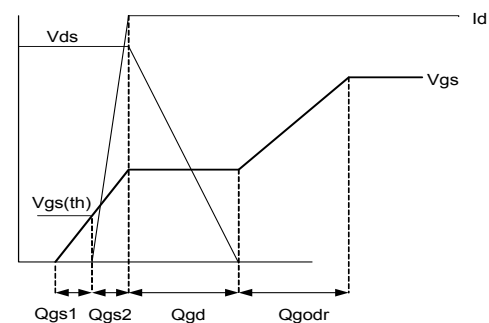
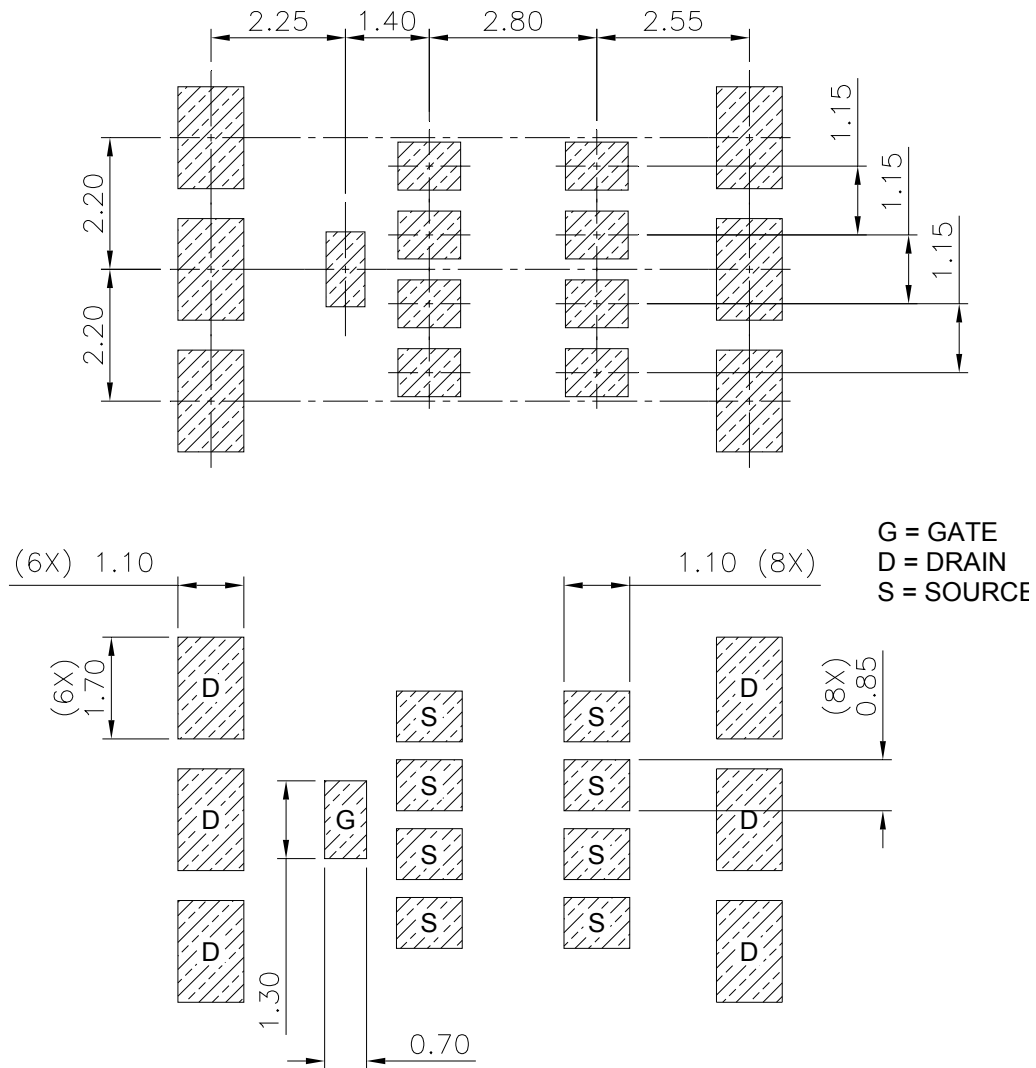

Fig 25b. Gate Charge Waveform

**DirectFET™ Board Footprint, L8 Outline
(Large Size Can, 8-Source Pads)**

Please see DirectFET™ application note [AN-1035](#) for all details regarding the assembly of DirectFET™. This includes all recommendations for stencil and substrate designs.



Note: For the most current drawing please refer to website at <http://www.irf.com/package/>

**DirectFET™ Outline Dimension, L8 Outline
(Large Size Can, 8-Source Pads)**

Please see DirectFET™ application note [AN-1035](#) for all details regarding the assembly of DirectFET™. This includes all recommendations for stencil and substrate designs.

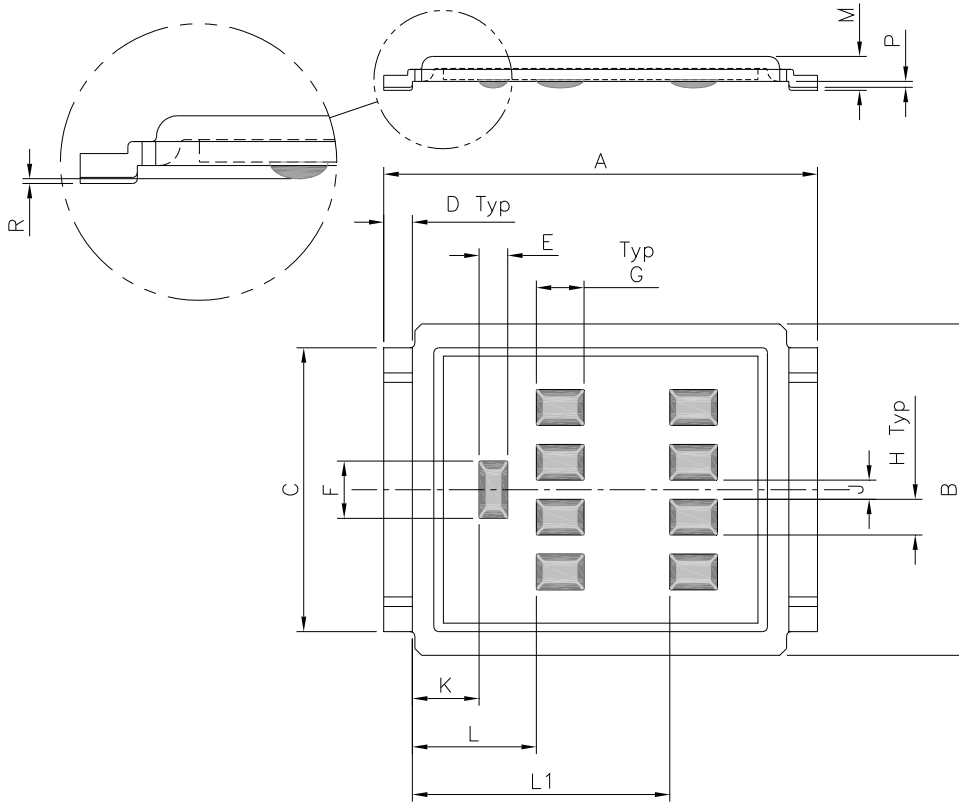

CODE	METRIC		IMPERIAL	
	MIN	MAX	MIN	MAX
A	9.05	9.15	0.356	0.360
B	6.85	7.10	0.270	0.280
C	5.90	6.00	0.232	0.236
D	0.55	0.65	0.022	0.026
E	0.58	0.62	0.023	0.024
F	1.18	1.22	0.046	0.048
G	0.98	1.02	0.039	0.040
H	0.73	0.77	0.029	0.030
J	0.38	0.42	0.015	0.017
K	1.35	1.45	0.053	0.057
L	2.55	2.65	0.100	0.104
L1	5.35	5.45	0.211	0.215
M	0.68	0.74	0.027	0.029
P	0.09	0.17	0.003	0.007
R	0.02	0.08	0.001	0.003

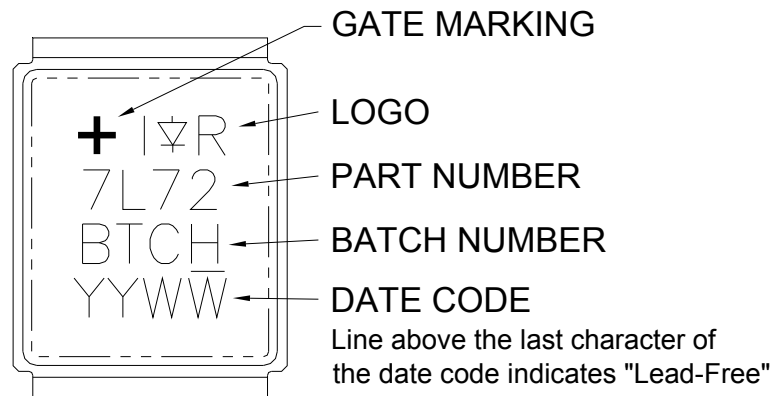
DirectFET™ Part Marking

Note: For the most current drawing please refer to website at <http://www.irf.com/package/>

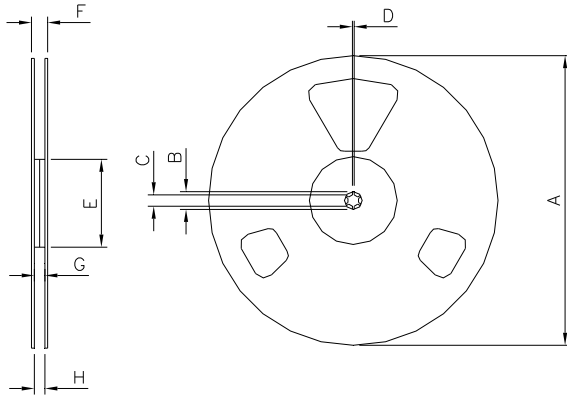
DirectFET™ Tape & Reel Dimension (Showing component orientation).

NOTE: Controlling dimensions in mm
Std reel quantity is 4000 parts. Order as IRL7472L1TRPbF).

REEL DIMENSIONS				
STANDARD OPTION (QTY 4000)				
CODE	METRIC		IMPERIAL	
	MIN	MAX	MIN	MAX
A	330.00	N.C	12.992	N.C
B	20.20	N.C	0.795	N.C
C	12.80	13.20	0.504	0.520
D	1.50	N.C	0.059	N.C
E	99.00	100.00	3.900	3.940
F	N.C	22.40	N.C	0.880
G	16.40	18.40	0.650	0.720
H	15.90	19.40	0.630	0.760

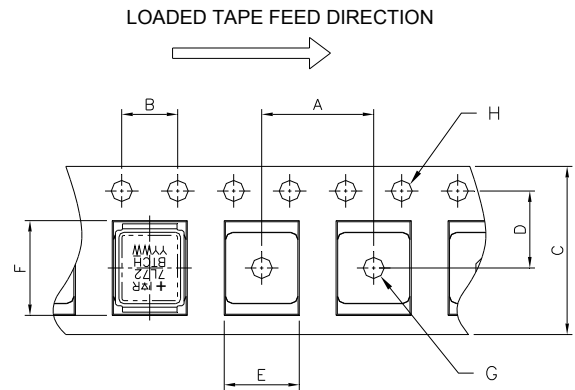

NOTE: CONTROLLING DIMENSIONS IN MM

CODE	DIMENSIONS			
	METRIC		IMPERIAL	
	MIN	MAX	MIN	MAX
A	11.90	12.10	4.69	0.476
B	3.90	4.10	0.154	0.161
C	15.90	16.30	0.623	0.642
D	7.40	7.60	0.291	0.299
E	7.20	7.40	0.283	0.291
F	9.90	10.10	0.390	0.398
G	1.50	N.C	0.059	N.C
H	1.50	1.60	0.059	0.063

Note: For the most current drawing please refer to website at <http://www.irf.com/package/>

Qualification Information

Qualification Level	Industrial * (per JEDEC JESD47F [†] guidelines)	
Moisture Sensitivity Level	DirectFET (Large -Can)	MSL1 (per JEDEC J-STD-020D [†])
RoHS Compliant	Yes	

[†] Applicable version of JEDEC standard at the time of product release.

* Industrial qualification standards except autoclave test conditions.

Revision History

Date	Comments
08/09/2016	<ul style="list-style-type: none"> • Changed datasheet with Infineon logo - all pages. • Changed max R_{dson} @ 10V/4.5V from “0.59mΩ /0.97mΩ” to “0.45mΩ” / 0.7mΩ” - on pages 1 & 2. • Changed ID @ TC 25C/100C from “564A/399A” to “645A/456A” - on pages 1 & 2. • Changed ID @ TA 25C from “59A” to “68A” - on pages 1 & 2. • Changed Fig.2 -on page 2.
10/14/2016	<ul style="list-style-type: none"> • Corrected Outline Dimension, L8 Outline on page 10.

Trademarks of Infineon Technologies AG

μHVIC™, μIPM™, μPFC™, AU-ConvertIR™, AURIX™, C166™, CanPAK™, CIPOS™, CIPURSE™, CoolDP™, CoolGaN™, COOLiR™, CoolMOS™, CoolSET™, CoolSiC™, DAVE™, DI-POL™, DirectFET™, DrBlade™, EasyPIM™, EconoBRIDGE™, EconoDUAL™, EconoPACK™, EconoPIM™, EiceDRIVER™, eupec™, FCOS™, GaNpowIR™, HEXFET™, HITFET™, HybridPACK™, iMOTION™, IRAM™, ISOFACE™, IsoPACK™, LEDrivr™, LITIX™, MIPAQ™, ModSTACK™, my-d™, NovalithIC™, OPTIGA™, OptiMOS™, ORIGA™, PowIRaudio™, PowIRstage™, PrimePACK™, PrimeSTACK™, PROFET™, PRO-SiL™, RASiC™, REAL3™, SmartLEWIS™, SOLID FLASH™, SPOC™, StrongIRFET™, SupIRBuck™, TEMPFET™, TRENCHSTOP™, TriCore™, UHVIC™, XHP™, XMC™

Trademarks updated November 2015

Other Trademarks

All referenced product or service names and trademarks are the property of their respective owners.

Edition 2016-04-19

Published by
Infineon Technologies AG
81726 Munich, Germany

© 2016 Infineon Technologies AG.
 All Rights Reserved.

Do you have a question about this document?
Email: erratum@infineon.com

Document reference
ifx1

IMPORTANT NOTICE

The information given in this document shall in no event be regarded as a guarantee of conditions or **characteristics (“Beschaffenheitsgarantie”)**.

With respect to any examples, hints or any typical values stated herein and/or any information regarding the application of the product, Infineon Technologies hereby disclaims any and all warranties and liabilities of any kind, including without limitation warranties of non-infringement of intellectual property rights of any third party.

In addition, any information given in this document **is subject to customer’s compliance with its obligations** stated in this document and any applicable legal requirements, norms and standards concerning customer’s products and any use of the product of Infineon Technologies in **customer’s applications**.

The data contained in this document is exclusively intended for technically trained staff. It is the **responsibility of customer’s technical departments** to evaluate the suitability of the product for the intended application and the completeness of the product information given in this document with respect to such application.

For further information on the product, technology, delivery terms and conditions and prices please contact your nearest Infineon Technologies office (www.infineon.com).

Please note that this product is not qualified according to the AEC Q100 or AEC Q101 documents of the Automotive Electronics Council.

WARNINGS

Due to technical requirements products may contain dangerous substances. For information on the types in question please contact your nearest Infineon Technologies office.

Except as otherwise explicitly approved by Infineon Technologies in a written document signed by authorized representatives of Infineon Technologies, **Infineon Technologies’ products may not be used** in any applications where a failure of the product or any consequences of the use thereof can reasonably be expected to result in personal injury.