



Chipsmall Limited consists of a professional team with an average of over 10 year of expertise in the distribution of electronic components. Based in Hongkong, we have already established firm and mutual-benefit business relationships with customers from,Europe,America and south Asia,supplying obsolete and hard-to-find components to meet their specific needs.

With the principle of “Quality Parts,Customers Priority,Honest Operation,and Considerate Service”,our business mainly focus on the distribution of electronic components. Line cards we deal with include Microchip,ALPS,ROHM,Xilinx,Pulse,ON,Everlight and Freescale. Main products comprise IC,Modules,Potentiometer,IC Socket,Relay,Connector.Our parts cover such applications as commercial,industrial, and automotives areas.

We are looking forward to setting up business relationship with you and hope to provide you with the best service and solution. Let us make a better world for our industry!



## Contact us

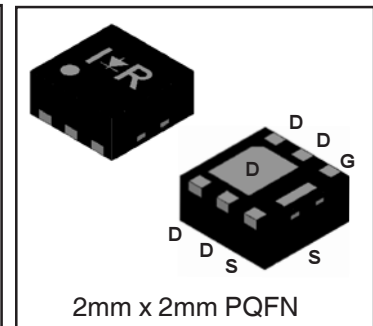
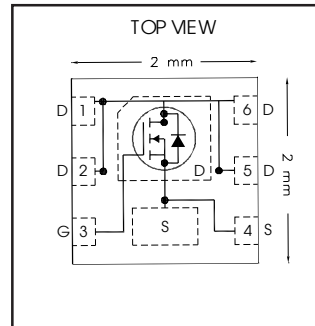
Tel: +86-755-8981 8866 Fax: +86-755-8427 6832

Email & Skype: info@chipsmall.com Web: www.chipsmall.com

Address: A1208, Overseas Decoration Building, #122 Zhenhua RD., Futian, Shenzhen, China



$V_{DS}$	<b>30</b>	<b>V</b>
$V_{GS}$	<b>±12</b>	<b>V</b>
$R_{DS(on) max}$ (@ $V_{GS} = 4.5V$ )	<b>15.5</b>	<b>mΩ</b>
$Q_g$ (typical)	<b>11</b>	<b>nC</b>
$I_D$ (@ $T_{C(Bottom)} = 25°C$ )	<b>12</b> Ⓓ	<b>A</b>



### Applications

- Charge and discharge switch for battery application
- System/Load Switch

### Features and Benefits

#### Features

Low $R_{DS(on)}$ ( $\leq 15.5m\Omega$ )
Low Thermal Resistance to PCB ( $\leq 13°C/W$ )
Low Profile ( $\leq 0.9$ mm)
Compatible with Existing Surface Mount Techniques
RoHS Compliant Containing no Lead, no Bromide and no Halogen
MSL1, Industrial Qualification

results in

#### Resulting Benefits

Lower Conduction Losses
Enable better thermal dissipation
Increased Power Density
Easier Manufacturing
Environmentally Friendlier
Increased Reliability

Orderable part number	Package Type	Standard Pack		Note
		Form	Quantity	
IRLHS6342TRPbF	PQFN 2mm x 2mm	Tape and Reel	4000	
IRLHS6342TR2PbF	PQFN 2mm x 2mm	Tape and Reel	400	EOL notice # 259

### Absolute Maximum Ratings

	Parameter	Max.	Units
$V_{DS}$	Drain-to-Source Voltage	30	V
$V_{GS}$	Gate-to-Source Voltage	±12	
$I_D @ T_A = 25°C$	Continuous Drain Current, $V_{GS} @ 10V$	8.7	A
$I_D @ T_A = 70°C$	Continuous Drain Current, $V_{GS} @ 10V$	6.9	
$I_D @ T_{C(Bottom)} = 25°C$	Continuous Drain Current, $V_{GS} @ 10V$	19Ⓓ	
$I_D @ T_{C(Bottom)} = 70°C$	Continuous Drain Current, $V_{GS} @ 10V$	15Ⓓ	
$I_D @ T_{C(Bottom)} = 25°C$	Continuous Drain Current, $V_{GS} @ 10V$ (Wirebond Limited)	12Ⓓ	
$I_{DM}$	Pulsed Drain Current ①	76	
$P_D @ T_A = 25°C$	Power Dissipation ⑤	2.1	W
$P_D @ T_A = 70°C$	Power Dissipation ⑤	1.3	
	Linear Derating Factor ⑤	0.02	W/°C
$T_J$ $T_{STG}$	Operating Junction and Storage Temperature Range	-55 to + 150	°C

Notes ① through ⑤ are on page 2

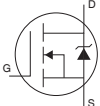
**Static @ T<sub>J</sub> = 25°C (unless otherwise specified)**

	Parameter	Min.	Typ.	Max.	Units	Conditions
BV <sub>DSS</sub>	Drain-to-Source Breakdown Voltage	30	—	—	V	V <sub>GS</sub> = 0V, I <sub>D</sub> = 250μA
ΔBV <sub>DSS</sub> /ΔT <sub>J</sub>	Breakdown Voltage Temp. Coefficient	—	22	—	mV/°C	Reference to 25°C, I <sub>D</sub> = 1mA
R <sub>DS(on)</sub>	Static Drain-to-Source On-Resistance	—	12.0	15.5	mΩ	V <sub>GS</sub> = 4.5V, I <sub>D</sub> = 8.5A ③
		—	15.0	19.5		V <sub>GS</sub> = 2.5V, I <sub>D</sub> = 8.5A ③
V <sub>GS(th)</sub>	Gate Threshold Voltage	0.5	—	1.1	V	V <sub>DS</sub> = V <sub>GS</sub> , I <sub>D</sub> = 10μA
ΔV <sub>GS(th)</sub>	Gate Threshold Voltage Coefficient	—	-4.2	—	mV/°C	
I <sub>DSS</sub>	Drain-to-Source Leakage Current	—	—	1.0	μA	V <sub>DS</sub> = 24V, V <sub>GS</sub> = 0V
		—	—	150		V <sub>DS</sub> = 24V, V <sub>GS</sub> = 0V, T <sub>J</sub> = 125°C
I <sub>GSS</sub>	Gate-to-Source Forward Leakage	—	—	100	nA	V <sub>GS</sub> = 12V
	Gate-to-Source Reverse Leakage	—	—	-100		V <sub>GS</sub> = -12V
g <sub>fs</sub>	Forward Transconductance	39	—	—	S	V <sub>DS</sub> = 10V, I <sub>D</sub> = 8.5A
Q <sub>g</sub>	Total Gate Charge	—	11	—	nC	V <sub>DS</sub> = 15V
Q <sub>gs</sub>	Gate-to-Source Charge	—	0.5	—		V <sub>GS</sub> = 4.5V
Q <sub>gd</sub>	Gate-to-Drain Charge	—	4.6	—		I <sub>D</sub> = 8.5A (See Fig. 6 & 17)
R <sub>G</sub>	Gate Resistance	—	2.1	—	Ω	
t <sub>d(on)</sub>	Turn-On Delay Time	—	4.9	—	ns	V <sub>DD</sub> = 15V, V <sub>GS</sub> = 4.5V
t <sub>r</sub>	Rise Time	—	13	—		I <sub>D</sub> = 8.5A
t <sub>d(off)</sub>	Turn-Off Delay Time	—	19	—		R <sub>G</sub> = 1.8Ω
t <sub>f</sub>	Fall Time	—	13	—		See Fig. 18
C <sub>iss</sub>	Input Capacitance	—	1019	—	pF	V <sub>GS</sub> = 0V
C <sub>oss</sub>	Output Capacitance	—	97	—		V <sub>DS</sub> = 25V
C <sub>rss</sub>	Reverse Transfer Capacitance	—	70	—		f = 1.0MHz

**Avalanche Characteristics**

	Parameter	Typ.	Max.	Units
E <sub>AS</sub>	Single Pulse Avalanche Energy ②	—	14	mJ
I <sub>AR</sub>	Avalanche Current ①	—	8.5	A

**Diode Characteristics**

	Parameter	Min.	Typ.	Max.	Units	Conditions
I <sub>S</sub>	Continuous Source Current (Body Diode)	—	—	12 <sup>⑦</sup>	A	MOSFET symbol showing the integral reverse p-n junction diode. 
I <sub>SM</sub>	Pulsed Source Current (Body Diode) ①	—	—	76		
V <sub>SD</sub>	Diode Forward Voltage	—	—	1.2	V	T <sub>J</sub> = 25°C, I <sub>S</sub> = 8.5A, V <sub>GS</sub> = 0V ③
t <sub>rr</sub>	Reverse Recovery Time	—	11	17	ns	T <sub>J</sub> = 25°C, I <sub>F</sub> = 8.5A, V <sub>DD</sub> = 15V
Q <sub>rr</sub>	Reverse Recovery Charge	—	13	20	nC	di/dt = 300 A/μs ③
t <sub>on</sub>	Forward Turn-On Time	Time is dominated by parasitic Inductance				

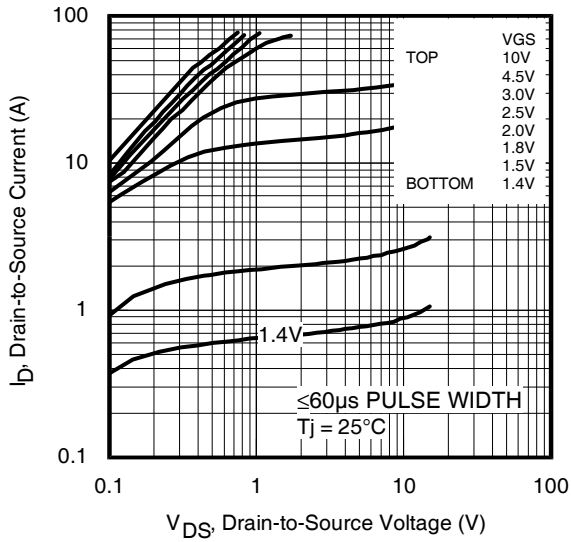
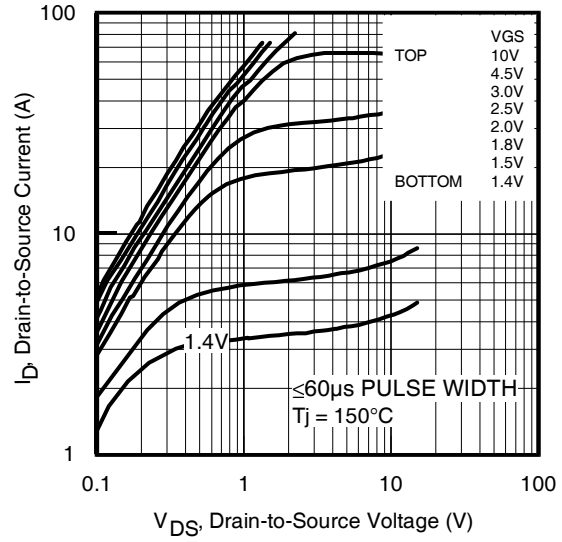
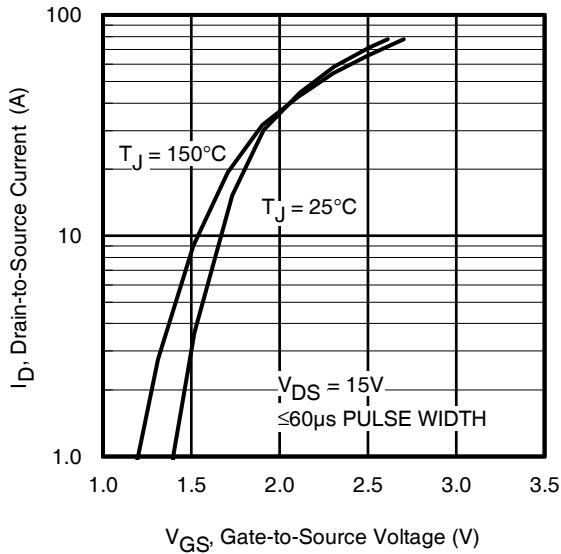
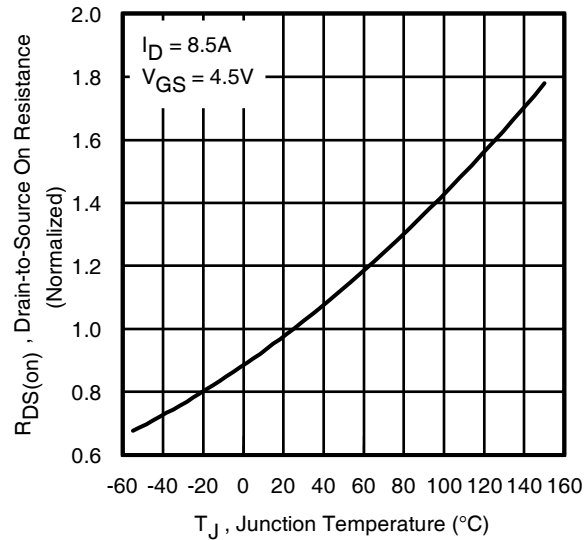
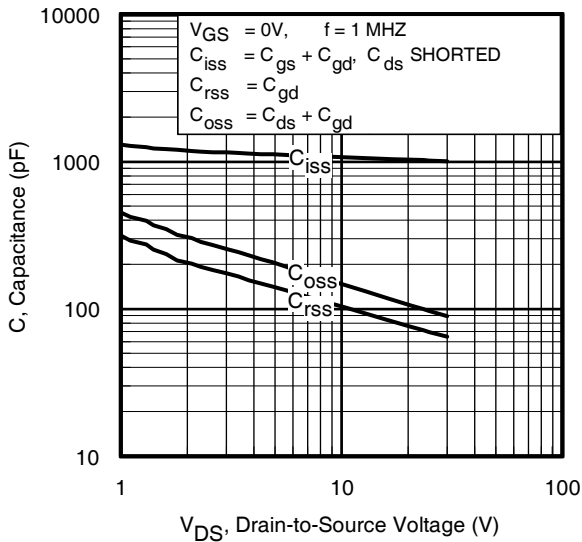
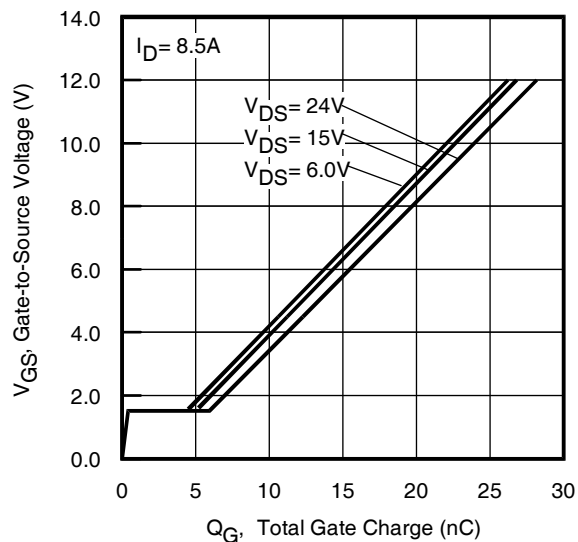
**Thermal Resistance**

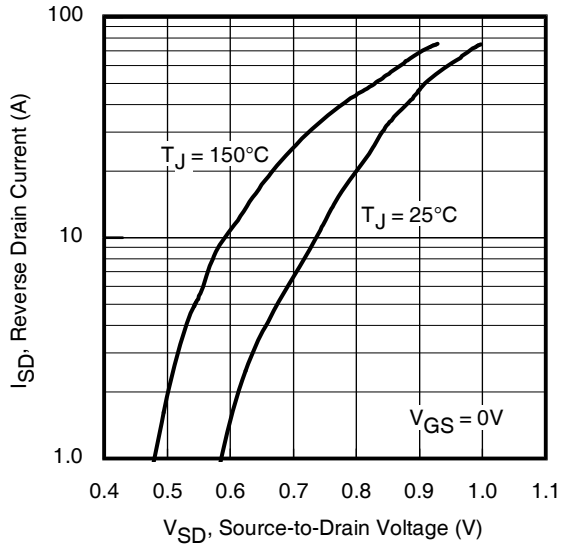
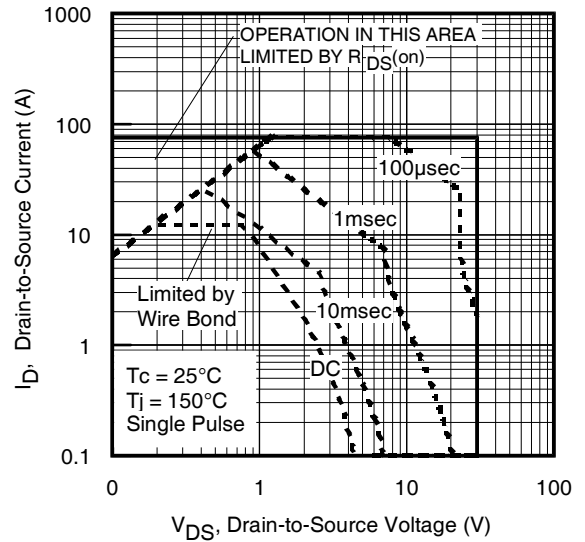
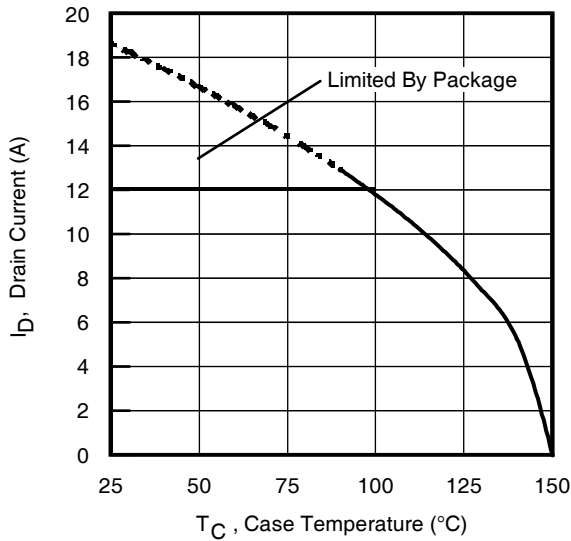
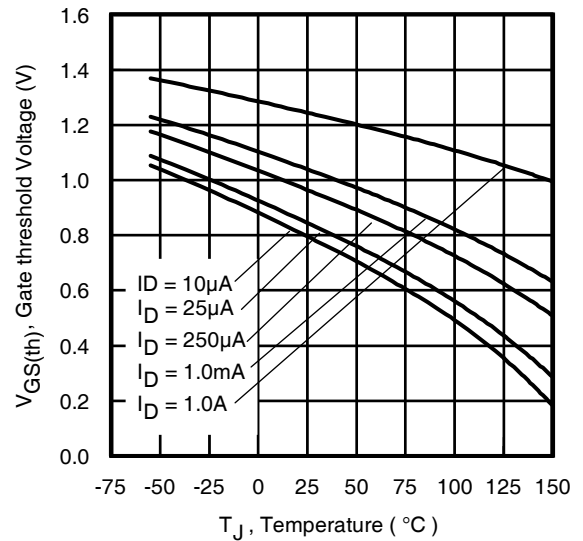
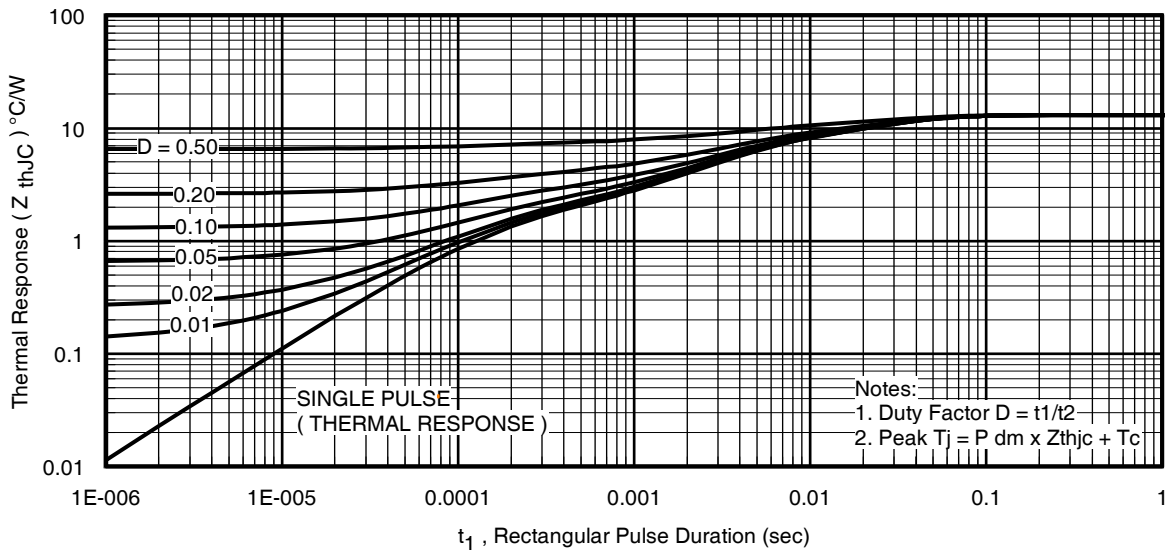
	Parameter	Typ.	Max.	Units
R <sub>θJC</sub> (Bottom)	Junction-to-Case ⑤	—	13	°C/W
R <sub>θJC</sub> (Top)	Junction-to-Case ⑤	—	90	
R <sub>θJA</sub>	Junction-to-Ambient ④	—	60	
R <sub>θJA</sub>	Junction-to-Ambient (<10s) ④	—	42	

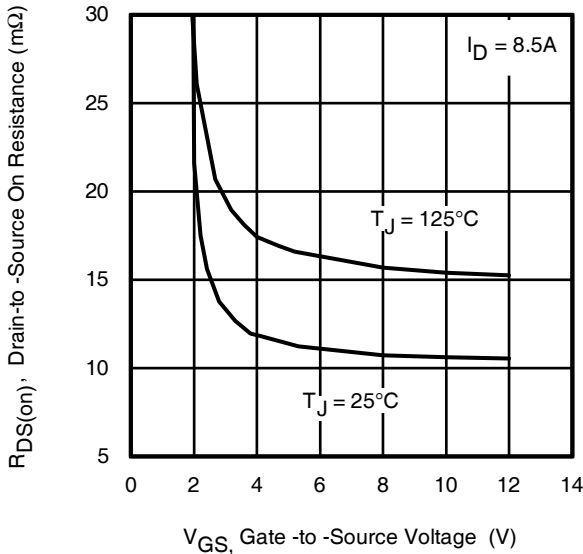
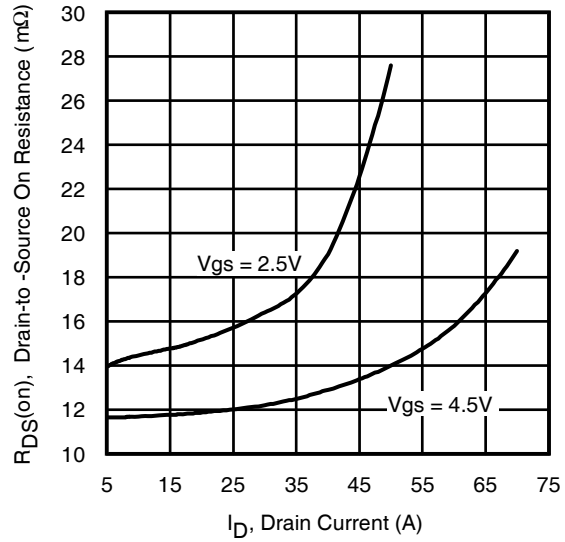
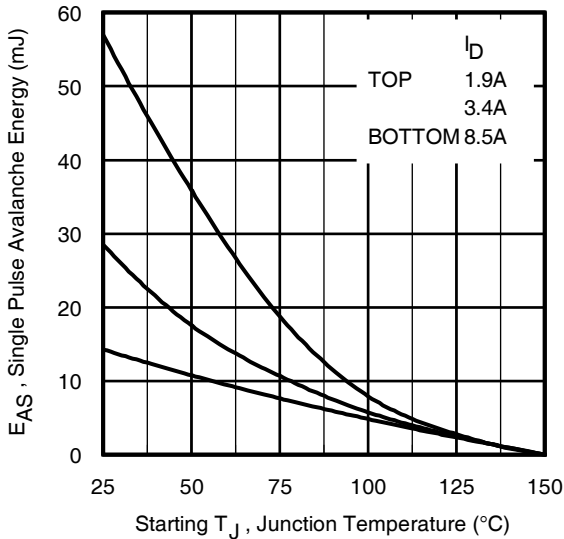
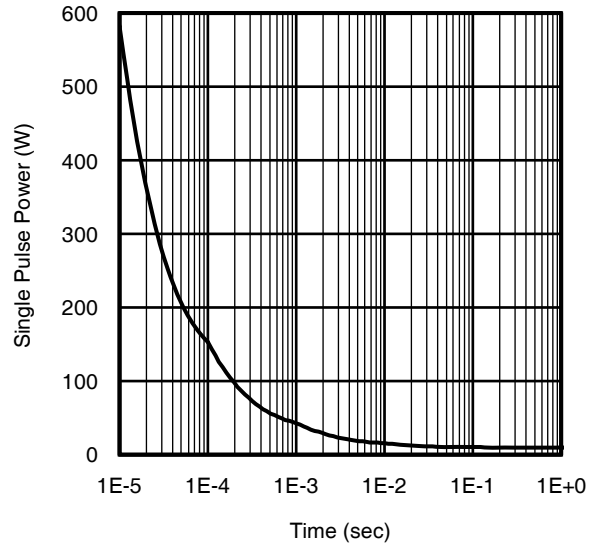
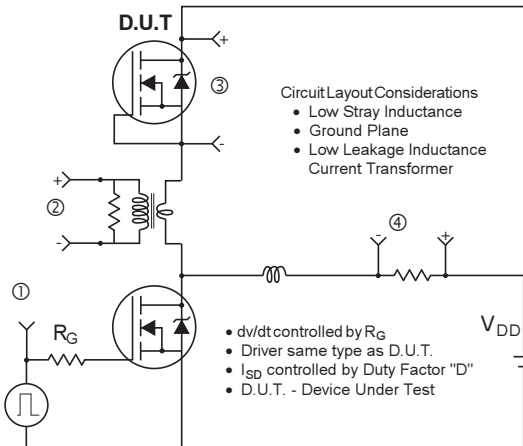
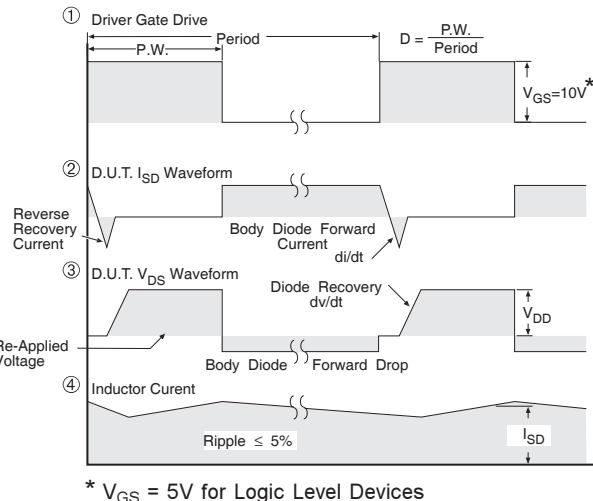
**Notes:**

- ① Repetitive rating; pulse width limited by max. junction temperature.
- ② Starting T<sub>J</sub> = 25°C, L = 0.39mH, R<sub>G</sub> = 50Ω, I<sub>AS</sub> = 8.5A.
- ③ Pulse width ≤ 400μs; duty cycle ≤ 2%.
- ④ R<sub>θ</sub> is measured at T<sub>J</sub> of approximately 90°C.
- ⑤ When mounted on 1 inch square 2 oz copper pad on 1.5x1.5 in. board of FR-4 material.
- ⑥ Calculated continuous current based on maximum allowable junction temperature.
- ⑦ Package is limited to 12A by die-source to lead-frame bonding technology

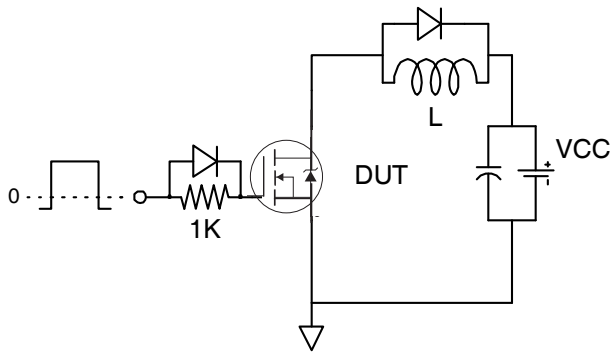
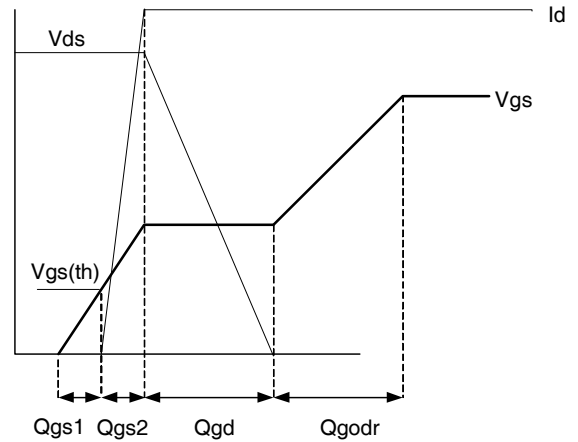
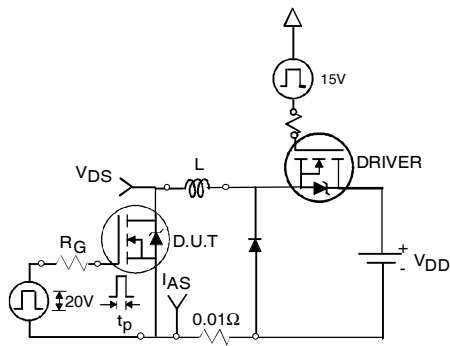
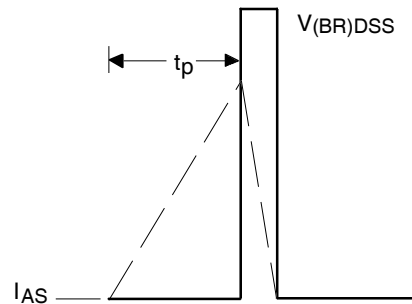
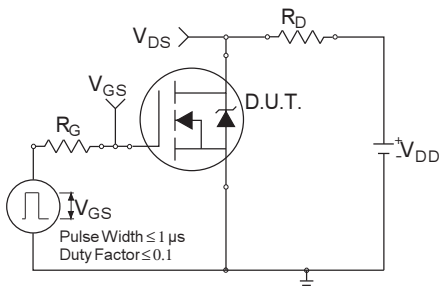
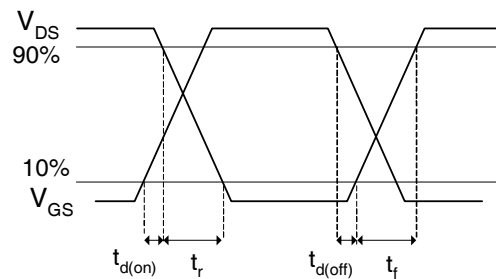



**Fig 1. Typical Output Characteristics**

**Fig 2. Typical Output Characteristics**

**Fig 3. Typical Transfer Characteristics**

**Fig 4. Normalized On-Resistance vs. Temperature**

**Fig 5. Typical Capacitance vs. Drain-to-Source Voltage**

**Fig 6. Typical Gate Charge vs. Gate-to-Source Voltage**

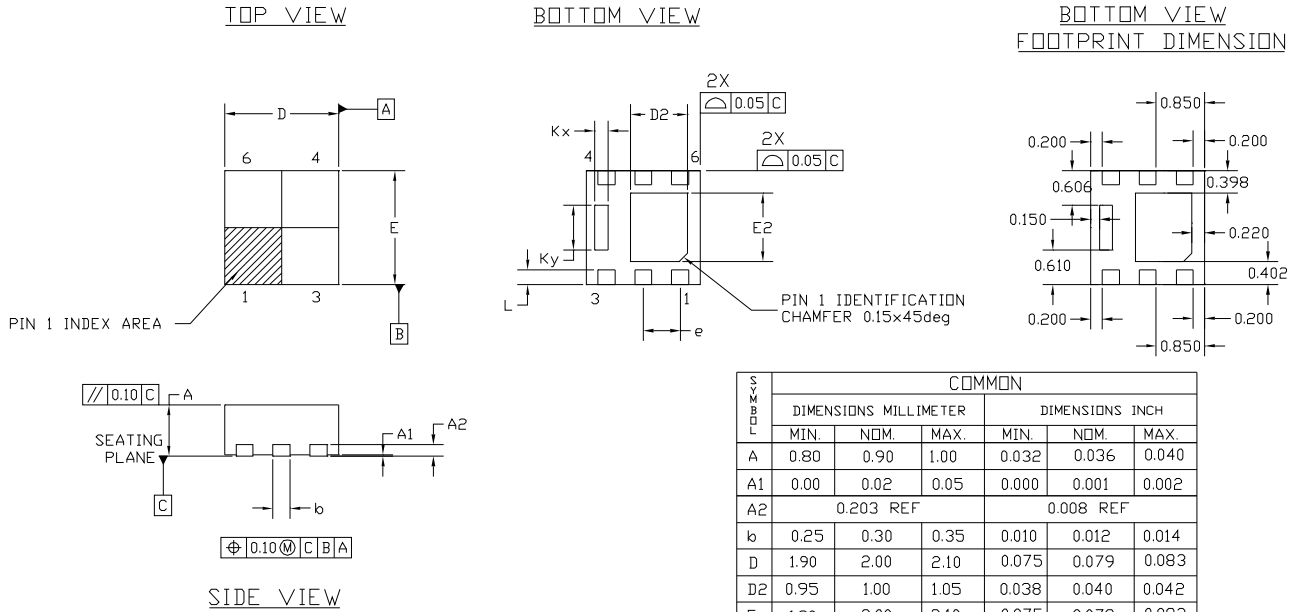

**Fig 7.** Typical Source-Drain Diode Forward Voltage

**Fig 8.** Maximum Safe Operating Area

**Fig 9.** Maximum Drain Current vs. Case (Bottom) Temperature

**Fig 10.** Threshold Voltage vs. Temperature

**Fig 11.** Maximum Effective Transient Thermal Impedance, Junction-to-Case (Bottom)


**Fig 12. On-Resistance vs. Gate Voltage**

**Fig 13. Typical On-Resistance vs. Drain Current**

**Fig 14. Maximum Avalanche Energy vs. Drain Current**

**Fig 15. Typical Power vs. Time**

**Fig 16. Peak Diode Recovery  $dv/dt$  Test Circuit for N-Channel HEXFET<sup>®</sup> Power MOSFETs**


\*  $V_{GS} = 5V$  for Logic Level Devices


**Fig 17a. Gate Charge Test Circuit**

**Fig 17b. Gate Charge Waveform**

**Fig 18a. Unclamped Inductive Test Circuit**

**Fig 18b. Unclamped Inductive Waveforms**

**Fig 19a. Switching Time Test Circuit**

**Fig 19b. Switching Time Waveforms**

# PQFN 2x2 Outline Package Details



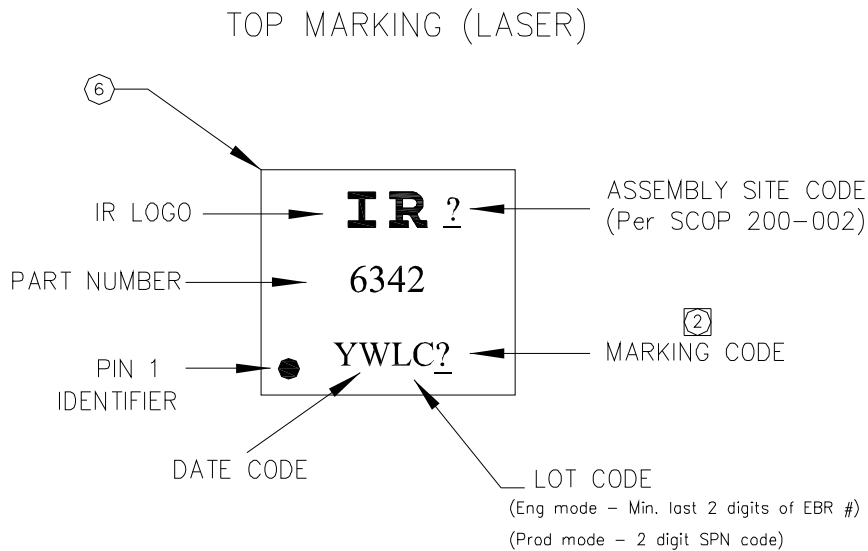
SYMBOL	COMMON					
	DIMENSIONS MILLIMETER			DIMENSIONS INCH		
	MIN.	NOM.	MAX.	MIN.	NOM.	MAX.
A	0.80	0.90	1.00	0.032	0.036	0.040
A1	0.00	0.02	0.05	0.000	0.001	0.002
A2	0.203 REF			0.008 REF		
b	0.25	0.30	0.35	0.010	0.012	0.014
D	1.90	2.00	2.10	0.075	0.079	0.083
D2	0.95	1.00	1.05	0.038	0.040	0.042
E	1.90	2.00	2.10	0.075	0.079	0.083
E2	1.15	1.20	1.25	0.046	0.048	0.050
e	0.65 BSC			0.026 BSC		
L	0.20	0.25	0.30	0.008	0.010	0.012
Kx	0.23 REF			0.010 REF		
Ky	0.785 REF			0.031 REF		

NOTES :

1. DIMENSION AND TOLERANCING CONFORM TO ASME Y14.5M-1994.
2. CONTROLLING DIMENSIONS : MILLIMETER
3. DIMENSION *b* APPLIES TO METALLIZED TERMINAL AND IS MEASURED BETWEEN 0.15 AND 0.30 mm. FROM TERMINAL TIP.

For footprint and stencil design recommendations, please refer to application note AN-1154 at <http://www.irf.com/technical-info/appnotes/an-1154.pdf>

## PQFN 2x2 Outline Part Marking



Note: For the most current drawing please refer to IR website at: <http://www.irf.com/package/>



# PQFN 2x2 Outline Tape and Reel

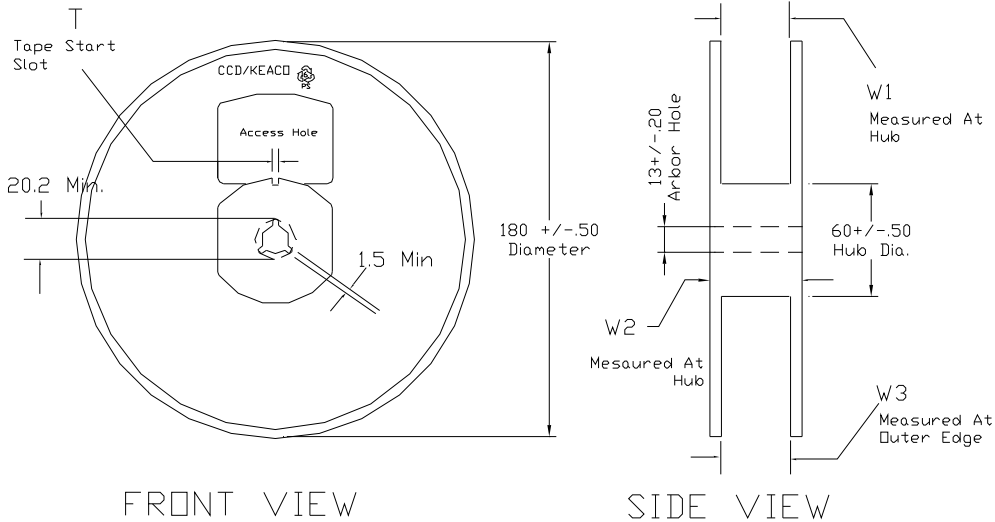
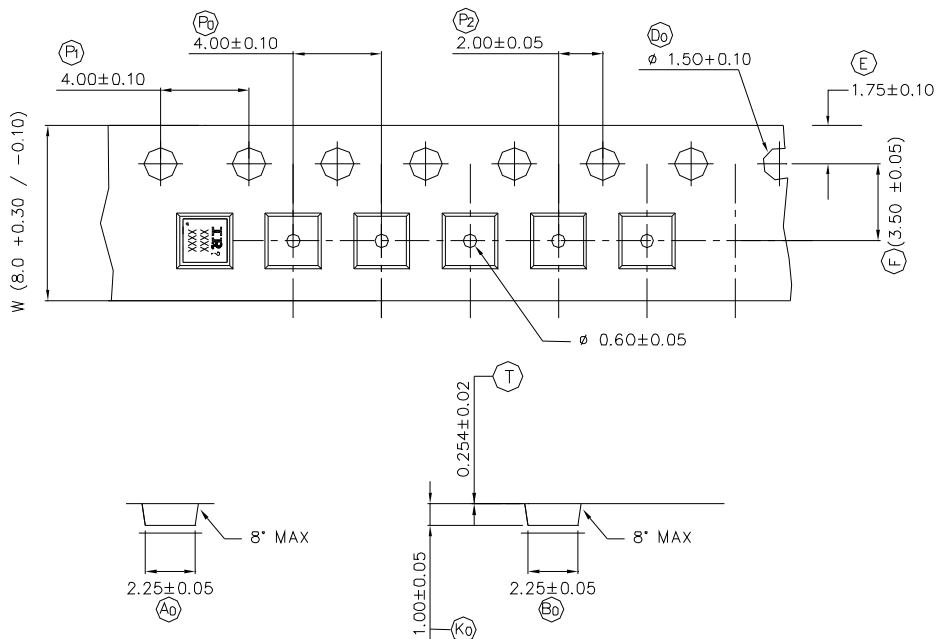


TABLE 1: REEL DETAILS

TAPE WIDTH	T	W1	W2	W3	PART NO
8 MM	3 ± 0.50	8.4 <sup>+1.5</sup> <sub>-0.0</sub>	14.4 Max	7.90 Min 10.9 Max	91586-1
12 MM	5 ± 0.50	12.4 <sup>+2.0</sup> <sub>-0.0</sub>	18.4 Max	11.9 Min 15.4 Max	91586-2

Note: Surface resistivity is  $\geq 1 \times 10^5$  but  $< 1 \times 10^{12}$  ohm/sq.



NOTE: The Surface Resistivity is  $10^4 - 10^8$  OHM/SQ

Note: For the most current drawing please refer to IR website at: <http://www.irf.com/package/>

**Qualification information<sup>†</sup>**

Qualification level	Industrial <sup>†</sup> (per JEDEC JESD47F <sup>††</sup> guidelines )	
Moisture Sensitivity Level	PQFN 2mm x 2mm	MSL1 (per JEDEC J-STD-020D <sup>††</sup> )
RoHS compliant	Yes	

† Qualification standards can be found at International Rectifier's web site  
<http://www.irf.com/product-info/reliability>

†† Applicable version of JEDEC standard at the time of product release.

**Revision History**

Date	Comments
12/17/2013	<ul style="list-style-type: none"> <li>Updated ordering information to reflect the End-Of-life (EOL) of the mini-reel option (EOL notice #259)</li> <li>Updated Qual level from "Consumer" to "Industrial" on page 1, 9</li> <li>Updated data sheet with new IR corporate template</li> </ul>