



Chipsmall Limited consists of a professional team with an average of over 10 year of expertise in the distribution of electronic components. Based in Hongkong, we have already established firm and mutual-benefit business relationships with customers from,Europe,America and south Asia,supplying obsolete and hard-to-find components to meet their specific needs.

With the principle of “Quality Parts,Customers Priority,Honest Operation,and Considerate Service”,our business mainly focus on the distribution of electronic components. Line cards we deal with include Microchip,ALPS,ROHM,Xilinx,Pulse,ON,Everlight and Freescale. Main products comprise IC,Modules,Potentiometer,IC Socket,Relay,Connector.Our parts cover such applications as commercial,industrial, and automotives areas.

We are looking forward to setting up business relationship with you and hope to provide you with the best service and solution. Let us make a better world for our industry!



## Contact us

Tel: +86-755-8981 8866 Fax: +86-755-8427 6832

Email & Skype: info@chipsmall.com Web: www.chipsmall.com

Address: A1208, Overseas Decoration Building, #122 Zhenhua RD., Futian, Shenzhen, China



# Infrared Remote Control Receiver Module

## IRM-8755K-1

### Features

- High protection ability against EMI.
- Circular lens to improve the receive characteristic.
- Line-up for various center carrier frequencies.
- Low voltage and low power consumption.
- High immunity against ambient light.
- Photodiode with integrated circuit.
- TTL and CMOS compatibility.
- Long reception distance.
- High sensitivity.
- Pb free



1 2 3

### Description

The IRM-8755K-1 device are miniature type infrared remote control system receiver which has been developed and designed by utilizing the most updated IC technology.

The PIN diode and preamplifier are assembled on lead frame, the epoxy package is designed as an IR filter.

The demodulated output signal can directly be decoded by a microprocessor.

### Pin Configuration

1. OUT
2. GND
3. V<sub>S</sub>

### Applications

- Light detecting portion of remote control
- AV instruments such as Audio, TV, VCR, CD, MD, etc.
- Home appliances such as Air-conditioner, Fan, etc.
- The other equipments with wireless remote control.
- CATV set top boxes
- Multi-media Equipment

### Application Circuit

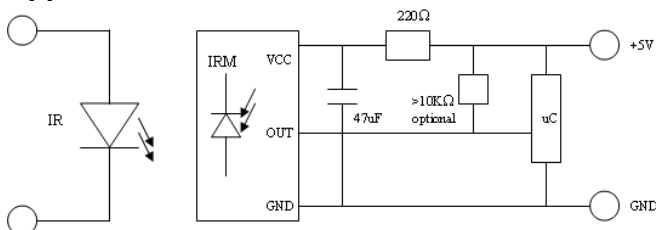

RC Filter should be connected closely between Vcc pin and GND pin.

### Block Diagram

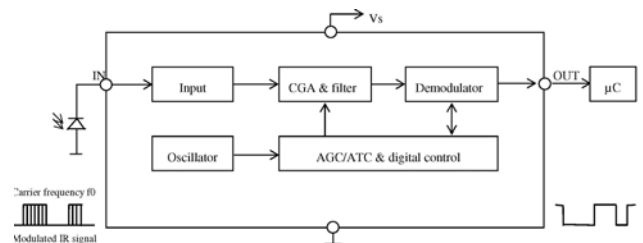

**Infrared Remote Control Receiver Module**

**IRM-8755K-1**

Parts Table

**Package Dimenstions**  
(Dimensions in mm)

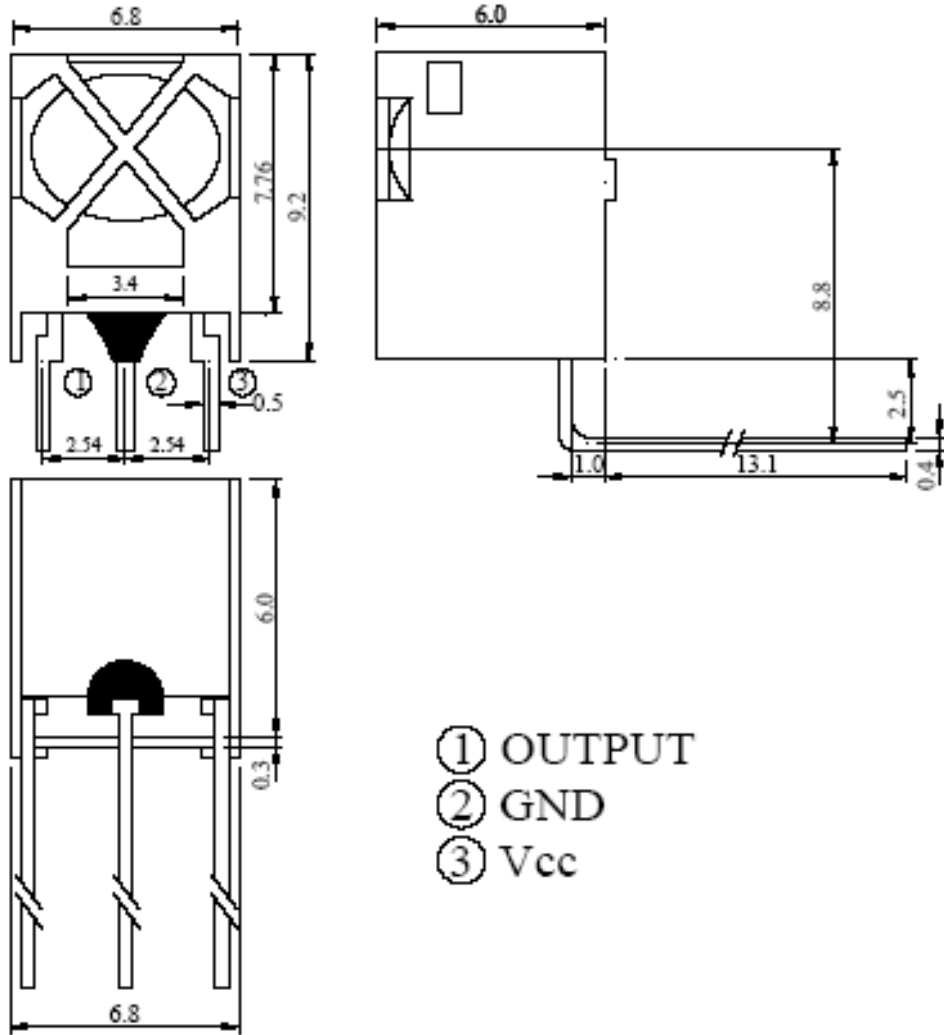

**Notes:**

Tolerances unless dimensions  $\pm 0.3$ mm.

# Infrared Remote Control Receiver Module

## IRM-8755K-1

### Absolute Maximum Ratings (T<sub>a</sub>=25°C)

Parameter	Symbol	Rating	Unit
Supply Voltage	V <sub>cc</sub>	6	V
Operating Temperature	T <sub>opr</sub>	-25 ~ +85	°C
Storage Temperature	T <sub>stg</sub>	-40 ~ +85	°C
Soldering Temperature <sup>*1</sup>	T <sub>sol</sub>	260	°C

\*1 4mm from mold body less than 10 seconds

### Electro-Optical Characteristics (T<sub>a</sub>=25°C and V<sub>cc</sub>=5.0V)

Parameter	Symbol	MIN.	TYP.	MAX.	Unit	Condition
Consumption Current	I <sub>cc</sub>	---	---	2	mA	No signal input
B.P.F Center Frequency	F <sub>o</sub>	---	33	---	KHz	
Peak Wavelength	λ <sub>p</sub>	---	940	---	nm	
Reception Distance	L <sub>0</sub>	8	---	---	m	At the ray axis *2.
	L <sub>45</sub>	4	---	---		
Half Angle(Horizontal)	Θ <sub>h</sub>	---	45	---	deg	
Half Angle(Vertical)	Θ <sub>v</sub>	---	45	---	deg	
High Level Pulse Width	T <sub>H</sub>	400	---	800	μs	
Low Level Pulse Width	T <sub>L</sub>	400	---	800	μs	
High Level Output Voltage	V <sub>H</sub>	4.5	---	---	V	
Low Level Output Voltage	V <sub>L</sub>	---	0.2	0.5	V	

\*2. The ray receiving surface at a vertex and relation to the ray axis in the range of θ=0° and θ=45°.

\*3. A range from 30cm to the arrival distance. Average value of 50 pulses.

# Infrared Remote Control Receiver Module

**IRM-8755K-1**

## Test Method

The specified electro-optical characteristics is satisfied under the following Conditions at the controllable distance.

1. Measurement place  
A place that is nothing of extreme light reflected in the room.
2. External light  
Project the light of ordinary white fluorescent lamps which are not high Frequency lamps and must be less then 10 Lux at the module surface.  
( $E_e \leq 10\text{Lux}$ )
3. Standard transmitter  
A transmitter whose output is so adjusted as to  **$V_o=400\text{mVp-p}$**  and the output Wave form shown in Fig.-1. According to the measurement method shown in Fig.-2 the standard transmitter is specified. However, the infrared photodiode to be used for the transmitter should be  $\lambda_p=940\text{nm}, \Delta\lambda=50\text{nm}$ . Also, photodiode is used of PD438B ( $V_r=5\text{V}$ ). (Standard light / Light source temperature  $2856^\circ\text{K}$ ).
4. Measuring system According to the measuring system shown in Fig.-3

Fig.-1 Transmitter Wave Form

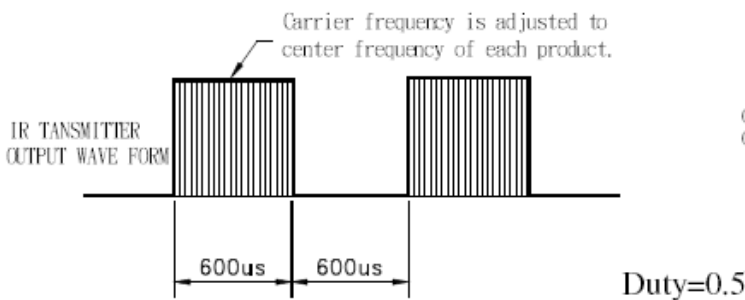

D.U.T output Pulse

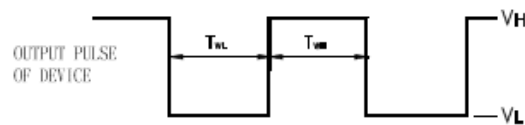

Fig.-2 Measuring Method

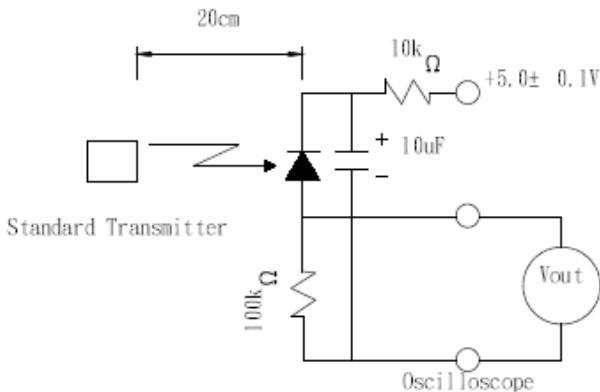
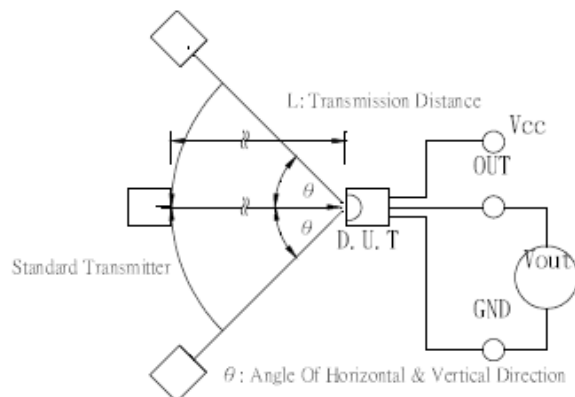

Fig.-3 Measuring System



**Typical Performance Curves**

Fig.-4 Relative Spectral Sensitivity vs. Wavelength

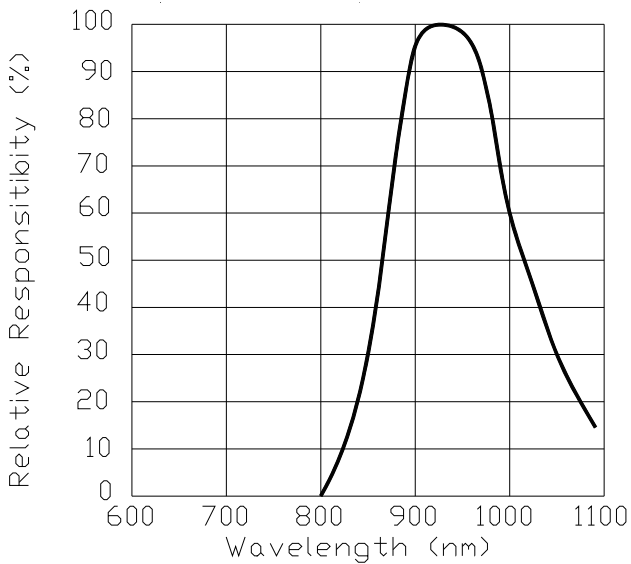

Fig.-5 Relative Transmission Distance vs. Direction

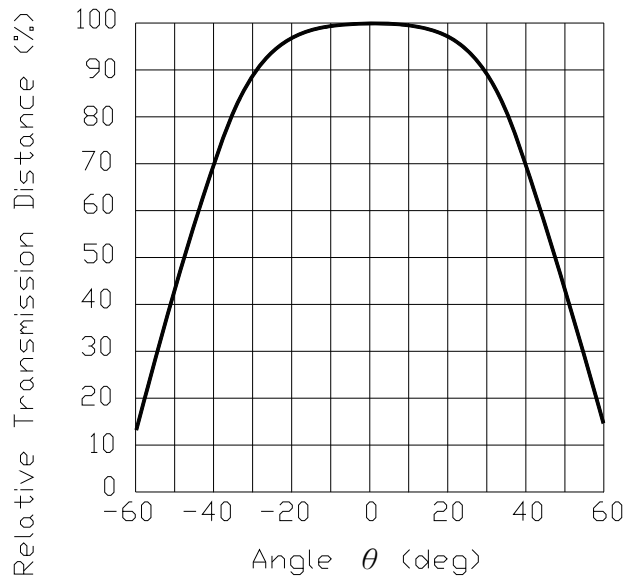

Fig.-6 Output Pulse Length vs. Arrival Distance

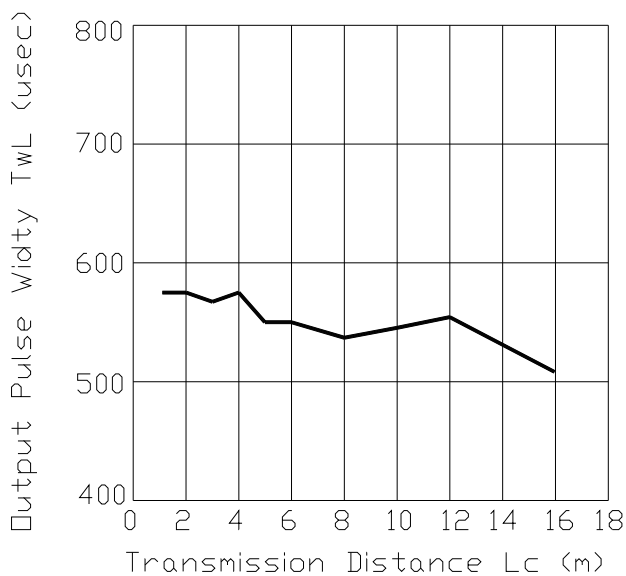

Fig.-7 Arrival Distance vs. Supply Voltage

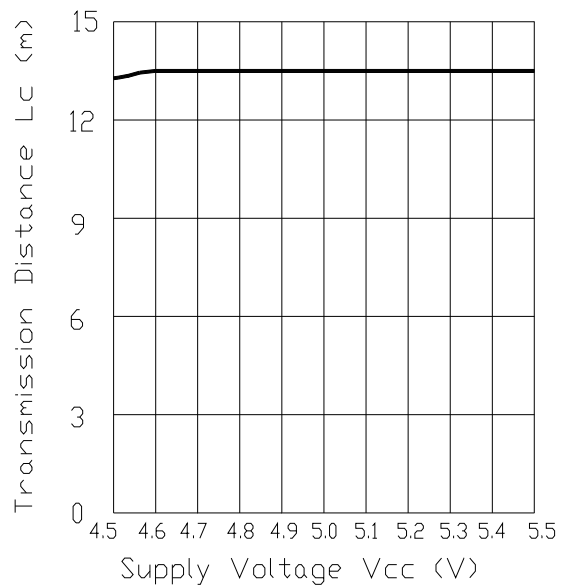
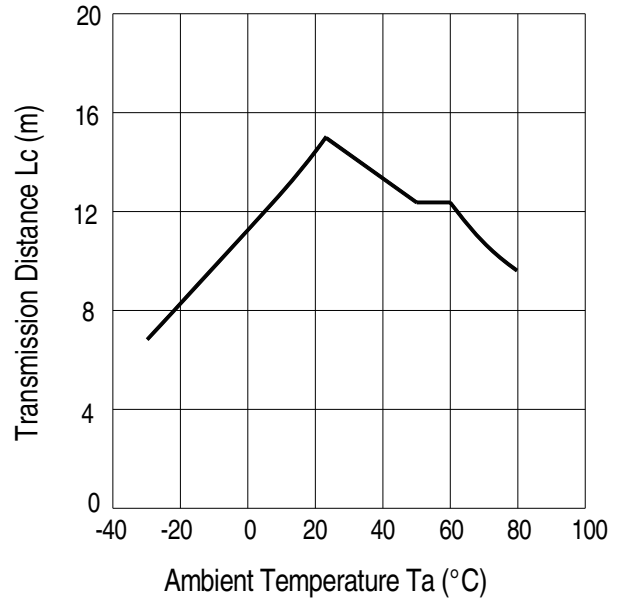
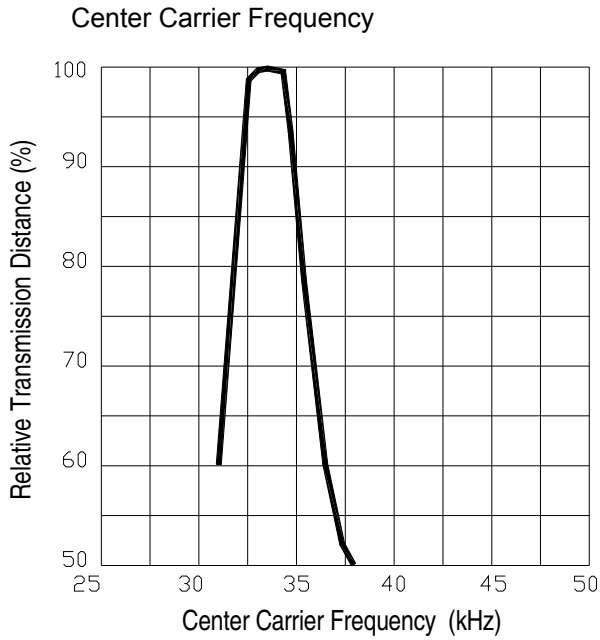

Fig.-8 Relative Transmission Distance

vs.

Fig.-9 Arrival Distance vs. Ambient Temperature



**Packing Quantity**

1000 pcs / Box

10 Boxes / Carton



## Infrared Remote Control Receiver Module

**IRM-8755K-1**

---

### DISCLAIMER

1. Above specification may be changed without notice. EVERLIGHT will reserve authority on material change for above specification.
2. When using this product, please observe the absolute maximum ratings and the instructions for use outlined in these specification sheets. EVERLIGHT assumes no responsibility for any damage resulting from use of the product which does not comply with the absolute maximum ratings and the instructions included in these specification sheets.
3. These specification sheets include materials protected under copyright of EVERLIGHT. Reproduction in any form is prohibited without the specific consent of EVERLIGHT.