



Chipsmall Limited consists of a professional team with an average of over 10 year of expertise in the distribution of electronic components. Based in Hongkong, we have already established firm and mutual-benefit business relationships with customers from,Europe,America and south Asia,supplying obsolete and hard-to-find components to meet their specific needs.

With the principle of “Quality Parts,Customers Priority,Honest Operation,and Considerate Service”,our business mainly focus on the distribution of electronic components. Line cards we deal with include Microchip,ALPS,ROHM,Xilinx,Pulse,ON,Everlight and Freescale. Main products comprise IC,Modules,Potentiometer,IC Socket,Relay,Connector.Our parts cover such applications as commercial,industrial, and automotives areas.

We are looking forward to setting up business relationship with you and hope to provide you with the best service and solution. Let us make a better world for our industry!



## Contact us

Tel: +86-755-8981 8866 Fax: +86-755-8427 6832

Email & Skype: info@chipsmall.com Web: www.chipsmall.com

Address: A1208, Overseas Decoration Building, #122 Zhenhua RD., Futian, Shenzhen, China





## Technical Data Sheet

### Infrared Remote-control Receiver Module

#### IRM-V5XX/TR1

#### Features

- High shielding against electric field disturbance.
- Circular lens to improve the receive characteristic.
- Line-up for various center carrier frequencies.
- Low voltage and low power consumption.
- High immunity against ambient light.
- Photodiode with integrated circuit.
- TTL and CMOS compatibility.
- Side-received SMD.
- Suitable burst length  $\geq 10$  pulses/burst.
- This product itself will remain within RoHS compliant version.
- Pb free.
- External dimensions 5.3(L)\*3.8(W)\*2.65(H) mm.



#### Descriptions

The device is a miniature SMD type infrared remote control system receiver that has been developed and designed by utilizing the most updated IC technology. The PIN diode and preamplifier are assembled on PCB, the epoxy package is designed as an IR filter. The demodulated output signal can directly be decoded by a microprocessor.

#### Applications

1. Light detecting portion of remote control
  - AV instruments such as Audio, TV, VCR, CD, MD, etc.
  - Home appliances such as Air-conditioner, Fan, etc.
  - The other equipments with wireless remote control.
  - CATV set top boxes
  - Multi-media Equipment

#### Device Selection Guide

PART	MATERIAL	COLOR
Chip	Silicon	---
Package	Epoxy	Black
Metal case	SPCC	Silver white

**IRM-V5XX/TR1**

**Package Dimensions**

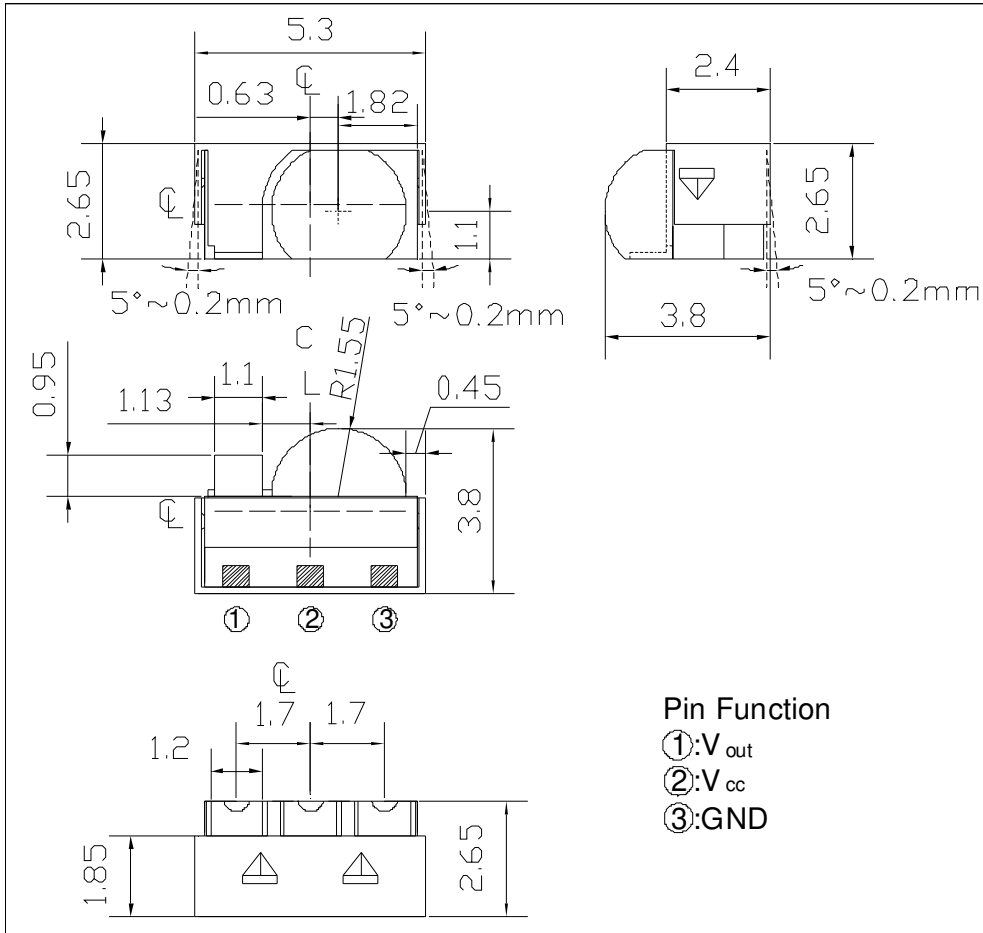

- Notes :**
1. All dimensions are in millimeters.
  2. Tolerances unless dimensions  $\pm 0.2$  mm.

**Soldering patterns**

The following soldering patterns are recommended for reflow-soldering:

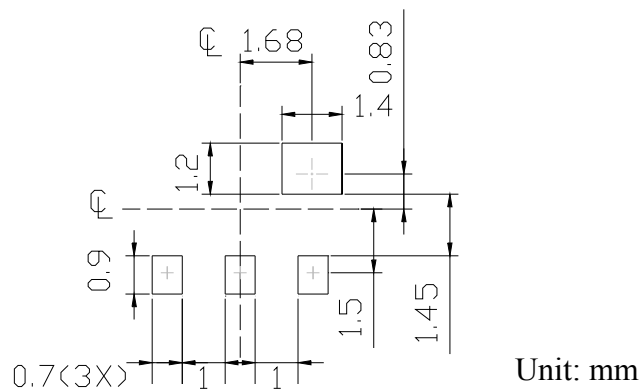

**IRM-V5XX/TR1**
**Available Parts for Different Carrier Frequencies**

Part	Carrier Frequency
IRM-V538/TR1	38 kHz
IRM-V536/TR1	36 kHz
IRM-V540/TR1	40 kHz

**Absolute Maximum Ratings (Ta=25°C)**

Parameter	Symbol	Rating	Unit	Notice
Supply Voltage	Vcc	0~6	V	
Operating Temperature	Topr	-25 ~ +85	°C	
Storage Temperature	Tstg	-40 ~ +85	°C	

**Recommended Operating Condition**

**Supply Voltage Rating: Vcc 2.7V to 5.5V**

**Electro-Optical Characteristics (Ta=25°C, and Vcc=3.0V)**

Parameter	Symbol	MIN.	TYP.	MAX.	Unit	Condition
Supply Current	Icc	---	---	1.2	mA	No signal input
Peak Wavelength	$\lambda_p$	---	940	---	nm	
Reception Distance	L <sub>0</sub>	8	---	---	m	At the ray axis *1
	L <sub>45</sub>	5	---	---		
Half Angle(Horizontal)	$\Theta_h$	---	45	---	deg	
Half Angle(Vertical)	$\Theta_v$	---	45	---	deg	
High Level Pulse Width	T <sub>H</sub>	400	---	800	μs	At the ray axis *2
Low Level Pulse Width	T <sub>L</sub>	400	---	800	μs	
High Level Output Voltage	V <sub>H</sub>	2.7	---	---	V	
Low Level Output Voltage	V <sub>L</sub>	---	0.2	0.5	V	

**Notes:**

\*1 : The ray receiving surface at a vertex and relation to the ray axis in the range of  $\theta = 0^\circ$  and  $\theta = 45^\circ$ .

\*2 : A range from 30cm to the arrival distance. Average value of 50 pulses

**IRM-V5XX/TR1**

**The Notice of Application:**

Transmission remote control signal consist of four parts: Encode Part, IR Transmitter Source, IRM device, Decode Part

1. When IRM-V5XX code select frequency, it need to well understand the center system of encode part.
2. Strong or weak light of IR Transmitter can affect distance of transmission.
3. Minimum Burst Length  $T_{burst}$  (number of pulses per burst): 10 cycles
4. It needs to ensure the translation range of decode part if it is applied to the pulse-width range.

If the above items hardly assure of its application, it'll cause NG (no good) message from the edge of signal.

**Test Method :**

The specified electro-optical characteristics are satisfied under the following conditions at the controllable distance.

①Measurement place

A place that is nothing of extreme light reflected in the room.

②External light

Project the light of ordinary white fluorescent lamps which are not high Frequency lamps and must be less then 10 Lux at the module surface.  
( $E_e \leq 10\text{Lux}$ )

③Standard transmitter

A transmitter whose output is so adjusted as to  **$V_o = 400 \text{ mVp-p}$**  and the output Wave form shown in Fig.-1. According to the measurement method shown in Fig.-2 the standard transmitter is specified.

However, the infrared photodiode to be used for the transmitter should be  $\lambda_p=940\text{nm}$ ,  $\Delta\lambda=50\text{nm}$ . Also, photodiode is used of PD438B ( $V_T=5\text{V}$ ).  
(Standard light / Light source temperature 2856°K).

④Measuring system

According to the measuring system shown in Fig.-3

Fig.-1 Transmitter Wave Form

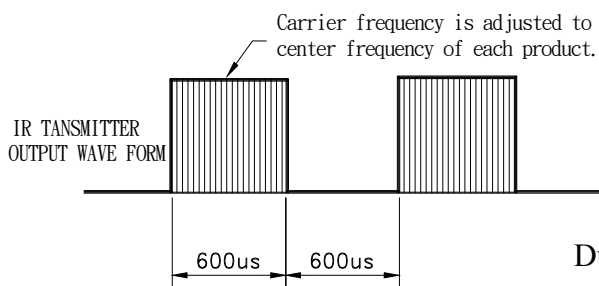

D.U.T output Pulse

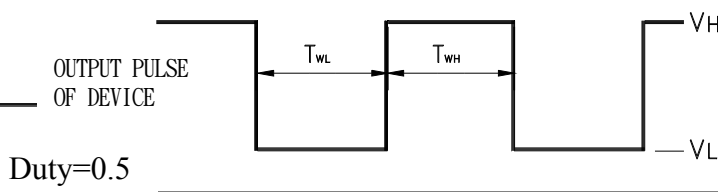

**IRM-V5XX/TR1**

Fig.-2 Measuring Method

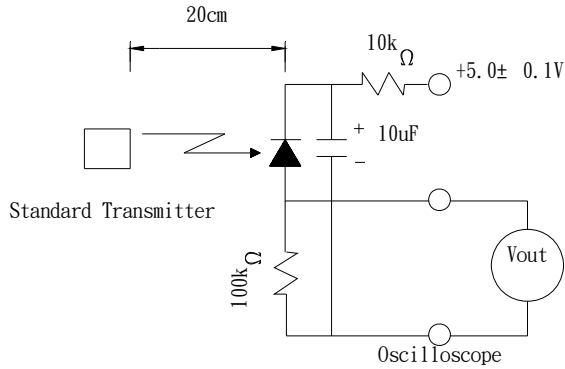
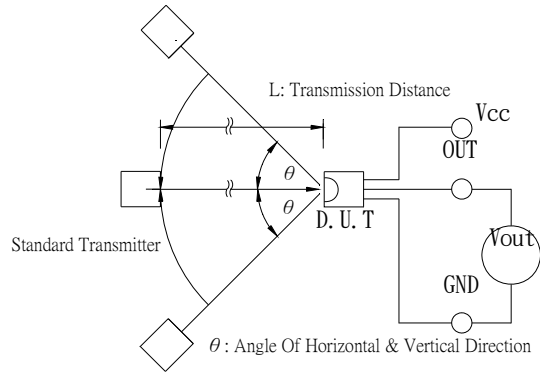
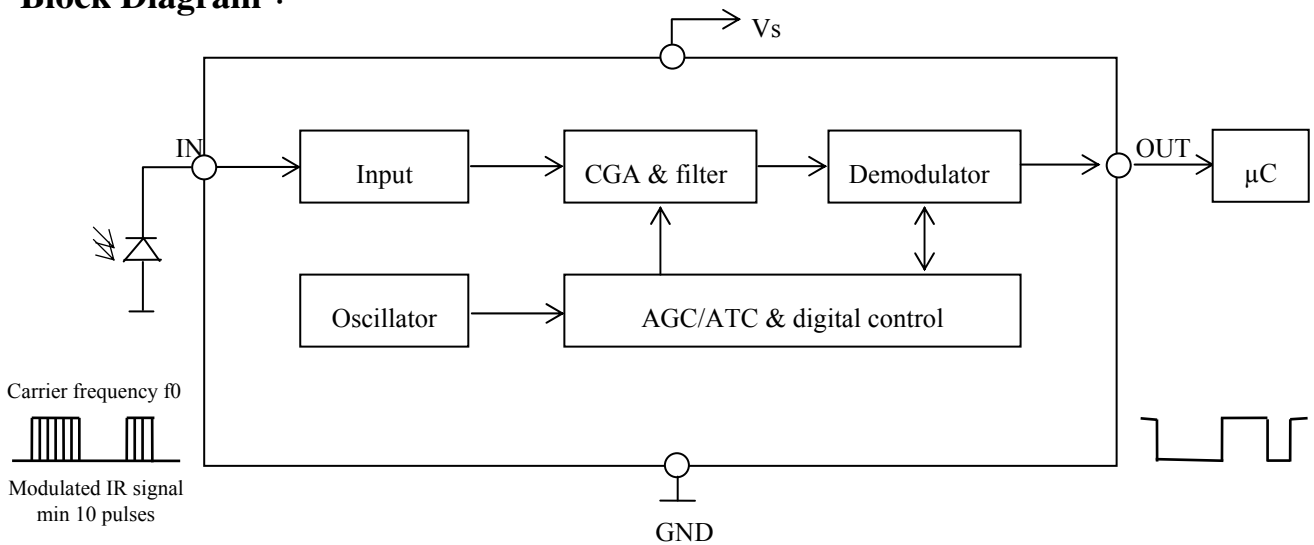

Fig.-3 Measuring System



**Block Diagram :**



**Application Circuit :**

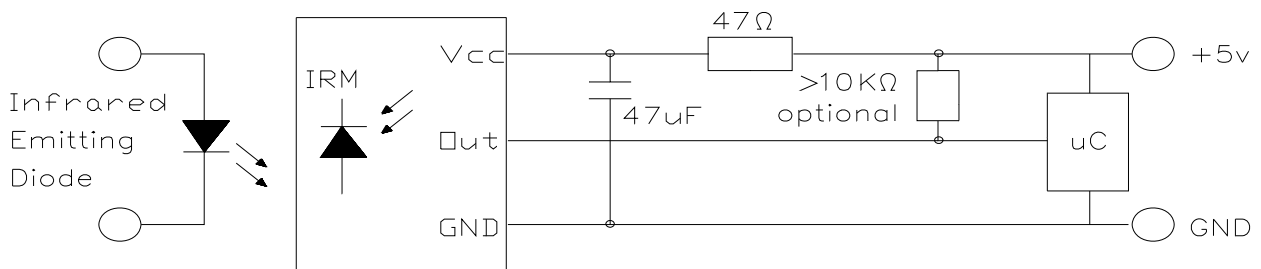

RC Filter should be connected closely between Vcc pin and GND pin.

**Typical Electro-Optical Characteristics Curves**

Fig.-4 Relative Spectral Sensitivity vs. Wavelength

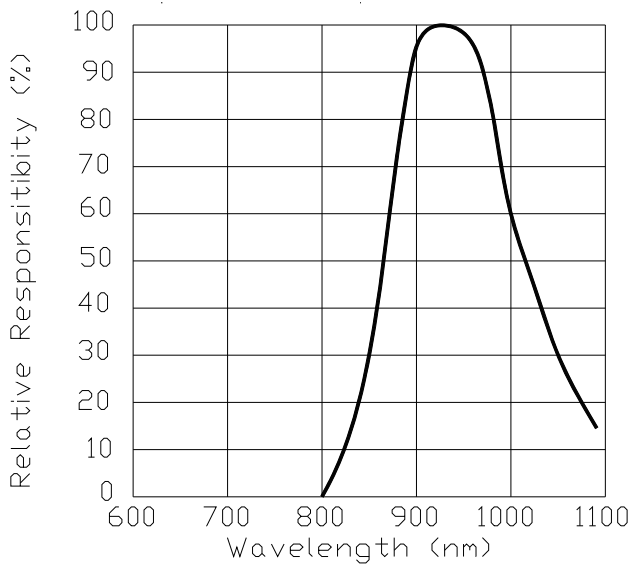

Fig.-5 Relative Transmission Distance vs. Direction

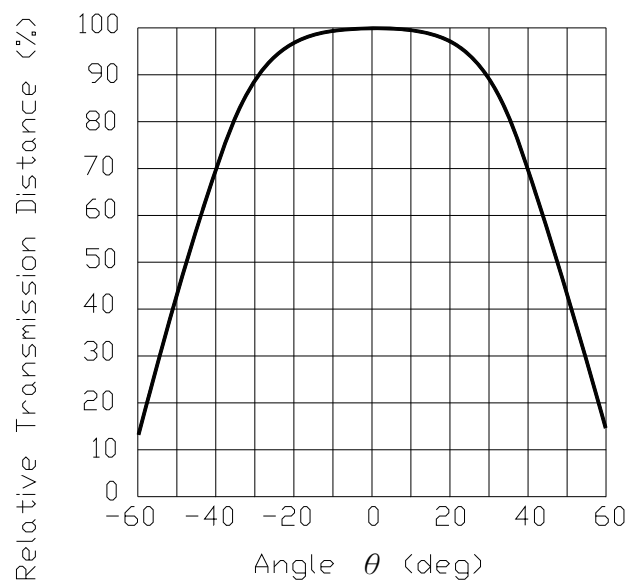

Fig.-6 Output Pulse Length vs. Arrival Distance

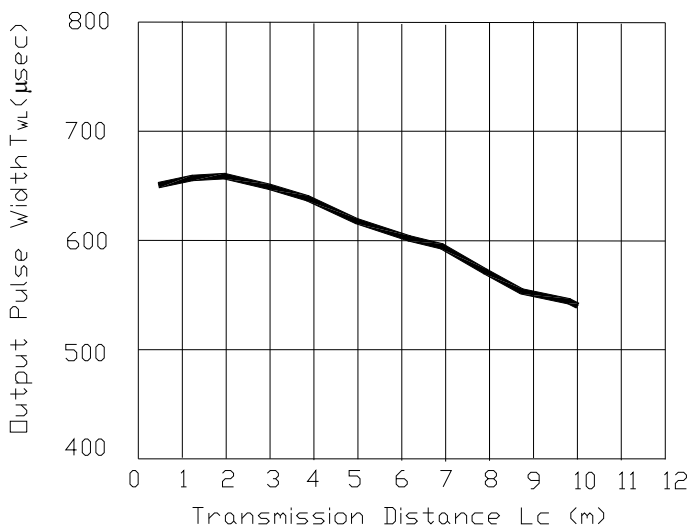
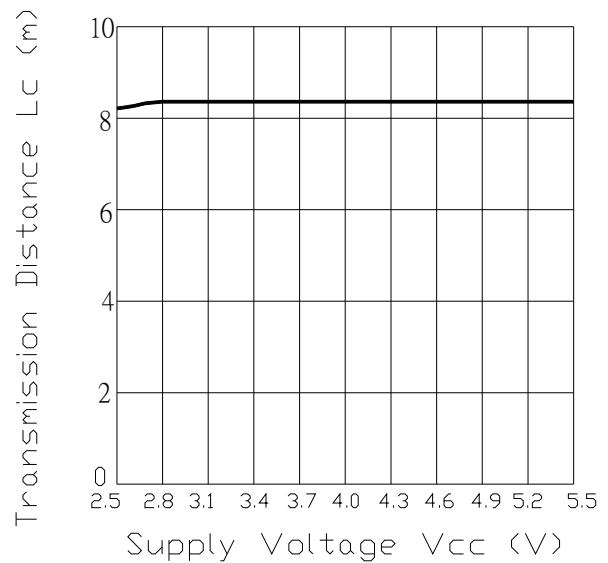

Fig.-7 Arrival Distance vs. Supply Voltage



**IRM-V5XX/TR1**

**Typical Electro-Optical Characteristics Curves**

Fig.-8 Arrival Distance vs. Ambient Temperature Fig.-9 Relative Transmission Distance vs. Center

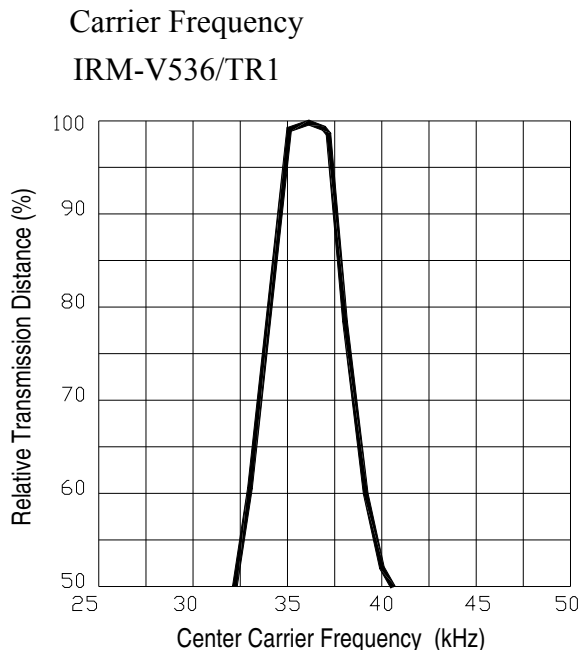
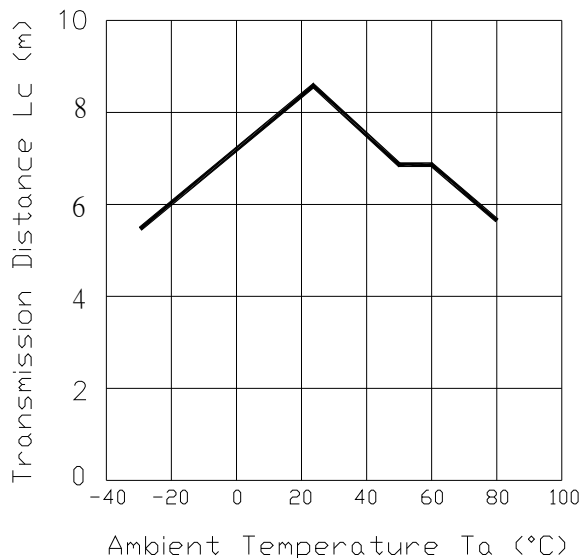
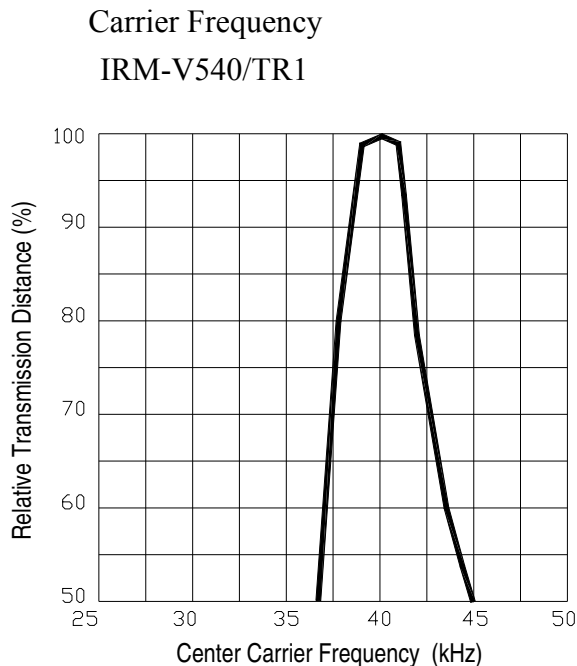
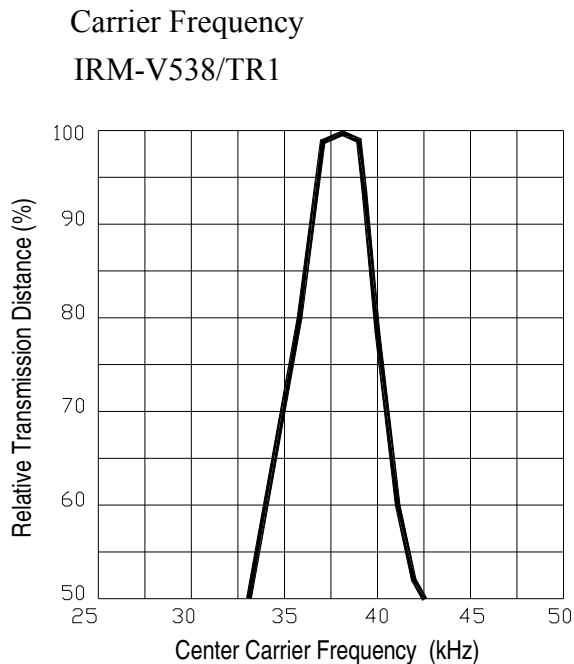

Fig.-9 Relative Transmission Distance vs. Center Carrier Frequency Fig.-9 Relative Transmission Distance vs. Center





**Reliability Test Item And Condition**

The reliability of products shall be satisfied with items listed below.

Confidence level : 90%

LTPD : 10%

Reflow Terms: JEDEC Level 4 Specification

Drying; Temp.:125°C 24hrs → Moisture 30°C / 60% RH 96hrs → Reflow Temp.: 260°C±5°C

10sec, 3 times

Note:

1. Not sooner than 15 minutes and not longer than 4 hours after removal from the temperature/humidity chamber.
2. The time between reflow shall be 5 minutes minimum and 60 minutes maximum.

Test Items	Test Conditions	Failure Judgments Criteria	<u>Samples(n)</u> Defective(c)
Temperature cycle	1 cycle : -25°C ↔ +85°C (30min)(5min)(30min) 300 cycle test	$L_0 \leq L \times 0.8$ $L_{45} \leq L \times 0.8$	n=76,c=0
High temperature test	Temp : +85°C Vcc : 5V 1000hrs	L: Lower specification limit	n=76,c=0
Low temperature storage	Temp : -40°C 1000hrs	*Icc : Operate Current (mA)	n=76,c=0
High temperature High humidity	Ta : 85°C , RH : 85% 1000hrs	Variation $\leq \pm 20\%$ :	n=76,c=0

**Recommended method of storage**

The following are general recommendations for moisture sensitive level (MSL) 4 storage and use:

- Shelf life in sealed bag: 12 months at < 40 °C and < 90% relative humidity (RH)
- After bag is opened, devices that will be subjected to reflow solder or other high temperature process must
  - a) Mounted within 72 hours of factory conditions < 30 °C/60%RH, or
  - b) Stored at <20% RH
- Devices require bake, before mounting, if:  
Humidity Indicator Card is > 20% when read at 23 ± 5 °C
- If baking is required, devices may be baked:
  - a) 192 hours at 40°C, and <5% RH(dry air/nitrogen) or
  - b) 96 hours at 60°C, and <5% RH for all device containers
  - c) 24 hours at 125 °C
- Soldering Condition
  - a) Pb-free solder temperature profile

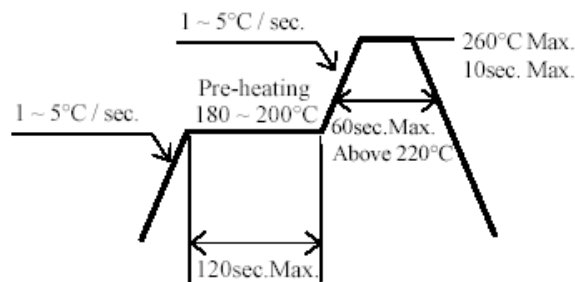

- b) Reflow soldering should not be done more than two times.
- c) When soldering, do not put stress on the unit during heating.
- d) After soldering, do not warp the circuit board.

## Soldering Iron

Each terminal is to go to the tip of soldering iron temperature less than 350°C for 3 seconds within once in less than the soldering iron capacity 25W. Leave two seconds and more intervals, and do soldering of each terminal. Be careful because the damage of the product is often started at the time of the hand solder.

## Repairing

Repair should not be done after the Devices have been soldered. When repairing is unavoidable, a double-head soldering iron should be used (as below figure). It should be confirmed beforehand whether the characteristics of the Devices will or will not be damaged by repairing.

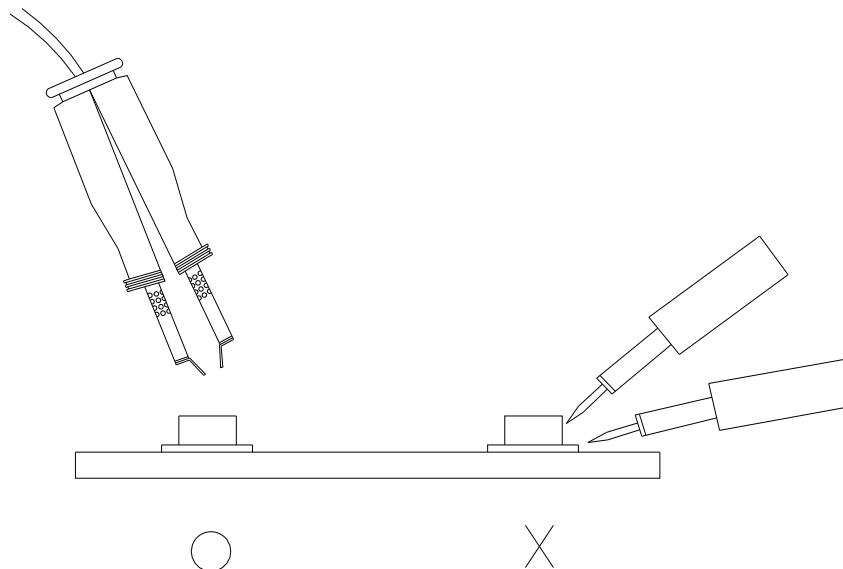

**IRM-V5XX/TR1**

**Packing Quantity Specification**

1. 2000 PCS/1 Reel
2. 5 Reel /1Carton

**Carrier Tape Dimensions: Loaded quantity 2000 PCS per reel**

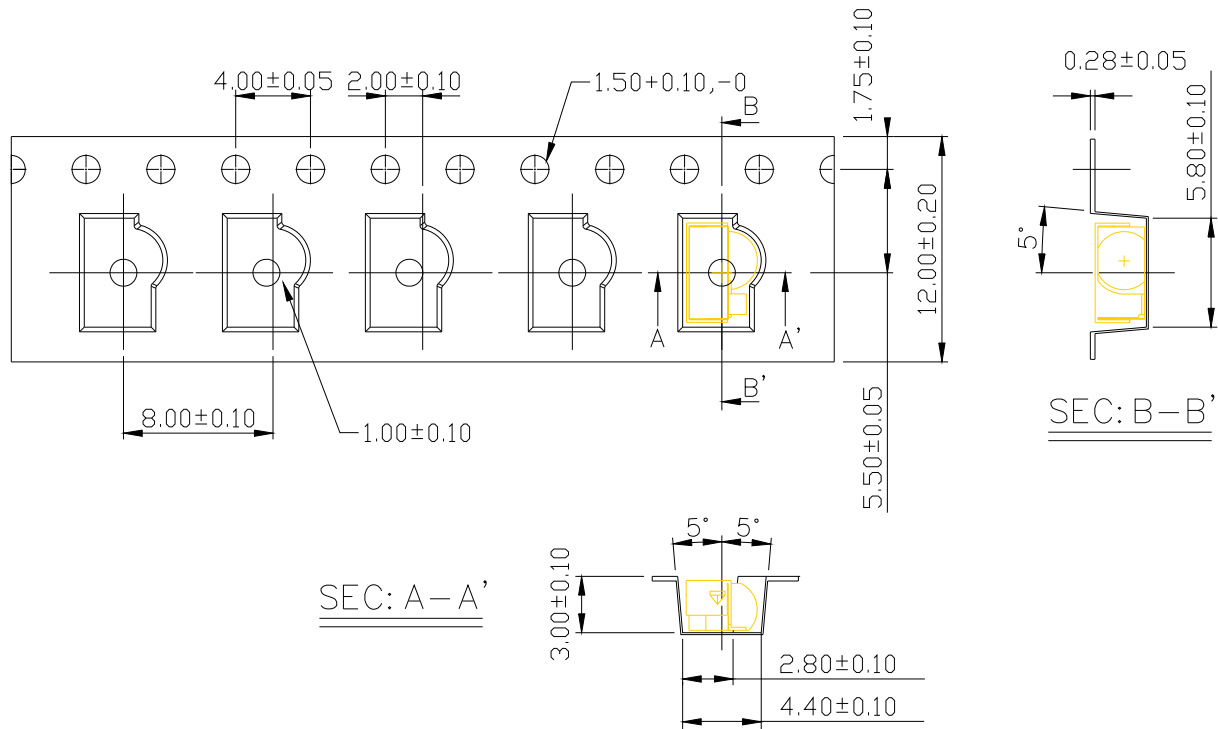

**Packing process**

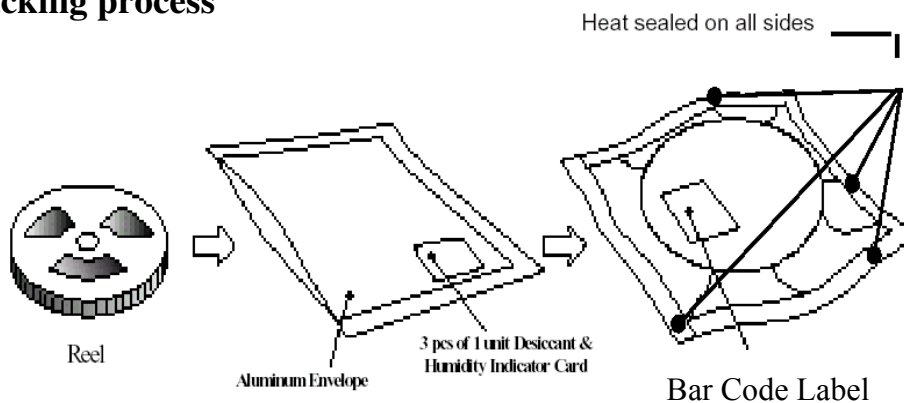

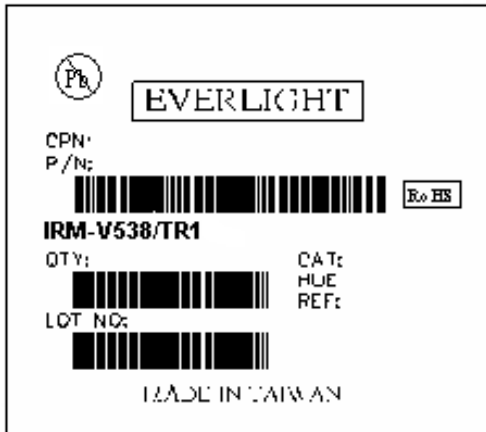
**Label Form Specification**

CPN: Customer's Production Number  
QTY: Packing Quantity  
CAT: None  
HUE: None  
REF: Reference  
LOT No: Lot Number  
MADE IN TAIWAN: Production Place

**Notes**

1. Above specification may be changed without notice. EVERLIGHT will reserve authority on material change for above specification.
2. When using this product, please observe the absolute maximum ratings and the instructions for using outlined in these specification sheets. EVERLIGHT assumes no responsibility for any damage resulting from use of the product which does not comply with the absolute maximum ratings and the instructions included in these specification sheets.
3. These specification sheets include materials protected under copyright of EVERLIGHT corporation. Please don't reproduce or cause anyone to reproduce them without EVERLIGHT's consent.

**EVERLIGHT ELECTRONICS CO., LTD.**  
Office: No 25, Lane 76, Sec 3, Chung Yang Rd,  
Tucheng, Taipei 236, Taiwan, R.O.C

Tel: 886-2-2267-2000, 2267-9936  
Fax: 886-2267-6244, 2267-6189, 2267-6306  
<http://www.everlight.com>