



Chipsmall Limited consists of a professional team with an average of over 10 year of expertise in the distribution of electronic components. Based in Hongkong, we have already established firm and mutual-benefit business relationships with customers from,Europe,America and south Asia,supplying obsolete and hard-to-find components to meet their specific needs.

With the principle of “Quality Parts,Customers Priority,Honest Operation,and Considerate Service”,our business mainly focus on the distribution of electronic components. Line cards we deal with include Microchip,ALPS,ROHM,Xilinx,Pulse,ON,Everlight and Freescale. Main products comprise IC,Modules,Potentiometer,IC Socket,Relay,Connector.Our parts cover such applications as commercial,industrial, and automotives areas.

We are looking forward to setting up business relationship with you and hope to provide you with the best service and solution. Let us make a better world for our industry!



## Contact us

Tel: +86-755-8981 8866 Fax: +86-755-8427 6832

Email & Skype: info@chipsmall.com Web: www.chipsmall.com

Address: A1208, Overseas Decoration Building, #122 Zhenhua RD., Futian, Shenzhen, China



**HIGH SIDE & DUAL LOW SIDE DRIVER IC**

**Features**

- 2 low side output channels sharing common ground
- 1 high side output channel
- CMOS Schmitt trigger inputs with pull down resistor
- Under voltage lockout on all channels
- 5 V compatible logic level Inputs
- Immune to  $-V_s$  spike and tolerant to  $dV_s/dt$  &  $dV_{ss}/dt$
- Shoot through prevention logic

**Descriptions**

The IRS21952 contains 2 low side outputs sharing common ground and 1 high side output. Low side drivers can tolerate up to -600 V below input signal (VSS: input supply return). High side driver can tolerate up to 600 V above low side ground (COM: low side supply return). The IRS21952 has better propagation delay and thermal characteristics compared to a photo-coupler driver. The logic inputs are compatible with standard CMOS or LSTTL output. Proprietary HVIC and latch-up immune CMOS technologies enable ruggedized monolithic construction.

**Product Summary**

$V_{\text{OFFSET}}$ (low side)	-600 V (VSS)
$V_{\text{OFFSET}}$ (high side)	600 V (COM)
$V_{\text{OUT}}$	10 V to 20 V
$t_{\text{on}}/t_{\text{off}}$ (typ)	330 ns/330 ns
$I_{\text{o+/-}}$	0.5 A/0.5 A

**Package**

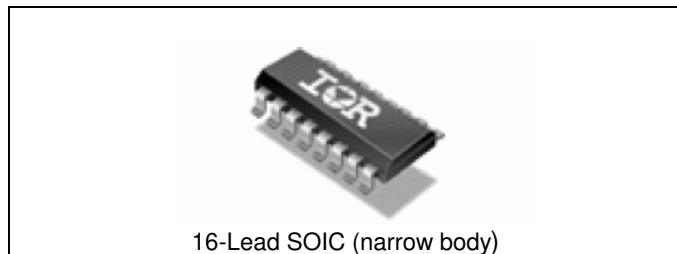

**Typical Connection Diagram**

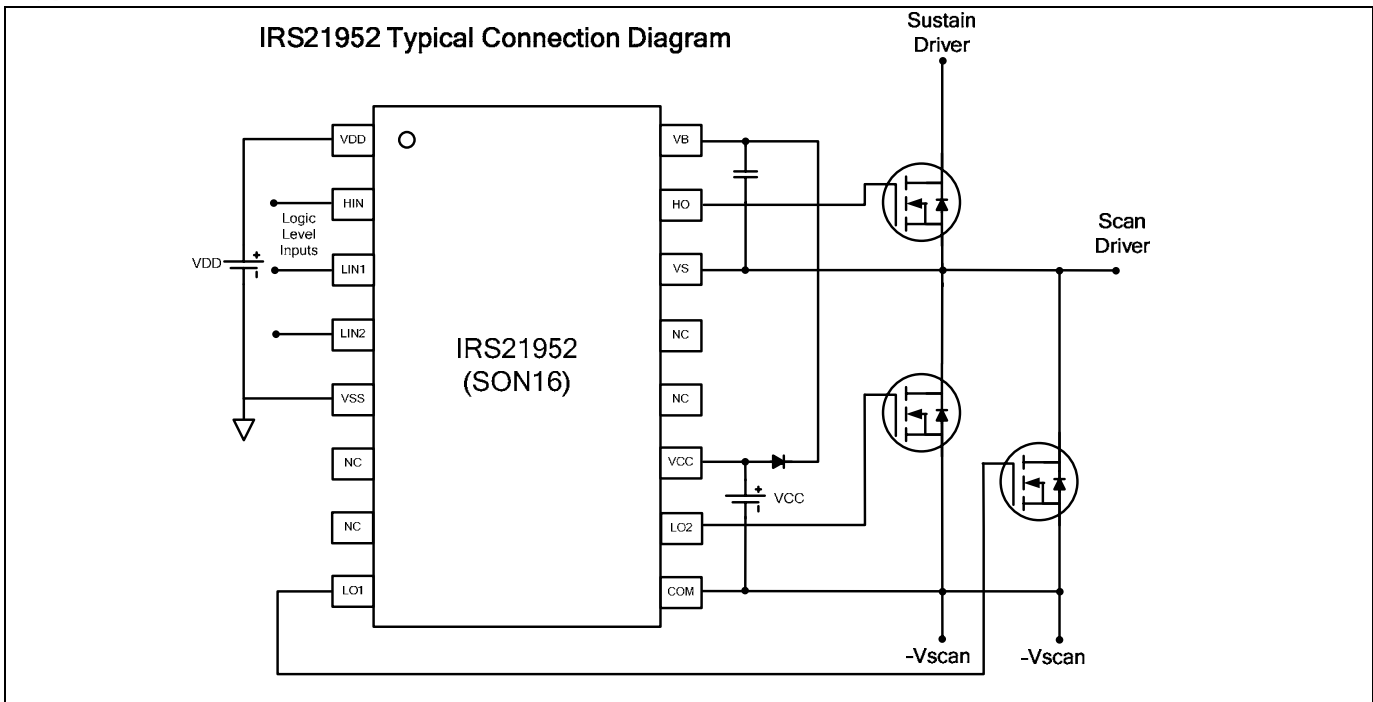

**Absolute Maximum Ratings**

Absolute maximum ratings indicate sustained limits beyond which damage to the device may occur. All voltage parameters are absolute voltages referenced to COM.

Symbol	Definition	Min	Max	Units	
HIN LIN1 LIN2	Floating logic level input voltage	VSS-0.3	VDD+0.3	V	
VDD	Floating logic input supply voltage	-0.3	625		
VSS	Floating logic input supply return voltage	VDD-25	VDD+0.3		
VB	High side floating well supply voltage	-0.3	625		
VS	High side floating well supply return voltage	VB-25	VB+0.3		
HO	High side floating gate drive output voltage	VS-0.3	VB+0.3		
VCC	Low side supply voltage	-0.3	25		
LO1 LO2	Low side output voltage	-0.3	VCC+0.3		
dVS/dt	Allowable VS offset transient relative to earth ground	-	50		V/ns
dVSS/dt	Allowable VSS offset transient relative to earth ground	-	50		V/ns
P <sub>D</sub>	Package power dissipation @ T <sub>A</sub> ≤ +25 °C	-	1	W	
R <sub>θJA</sub>	Thermal resistance, junction to ambient	-	100	°C/W	
T <sub>J</sub>	Junction temperature	-55	150	°C	
T <sub>S</sub>	Storage temperature	-55	150	°C	
T <sub>L</sub>	Lead temperature (soldering, 10 seconds)	-	300	°C	

**Recommended Operating Conditions**

For proper operation, the device should be used within the recommended conditions. All voltage parameters are absolute voltages referenced to COM.

Symbol	Definition	Min	Max	Units
HIN LIN1 LIN2	Floating logic level input voltage	VSS	VDD	V
VDD	Floating logic input supply voltage	VSS+4.5	VSS+5.5	
VSS	Floating logic input supply return voltage	-5	600	
VB	High side floating well supply voltage	VS+10	VS+20	
VS	High side floating well supply return voltage	-5	600	
HO	High side floating gate drive output voltage	VS	VB	
VCC	Low side supply voltage	10	20	
LO1 LO2	Low side output voltage	0	VCC	
T <sub>A</sub>	Ambient temperature	-40	125	°C

Note 1: Logic operation for V<sub>S</sub> of -5 V to 600 V. Logic state held for V<sub>S</sub> of -5 V to -V<sub>BS</sub>. (Please refer to Design Tip DT97-3 for more details).

**Static Electrical Characteristics**

(V<sub>B</sub>-V<sub>S</sub>)=15 V. The V<sub>IN</sub>, V<sub>IN,TH</sub>, V<sub>BSUV</sub>, V<sub>O</sub>, I<sub>O</sub> and I<sub>IN</sub> parameters are referenced to V<sub>S</sub>. T<sub>A</sub> = 25 °C unless otherwise specified.

Symbol	Definition	Min	Typ	Max	Units	Test Conditions	
V <sub>CCUV+</sub>	V <sub>CC</sub> supply undervoltage positive going threshold	7.5	8.6	9.7	V		
V <sub>CCUV-</sub>	V <sub>CC</sub> supply undervoltage negative going threshold	7.0	8.2	9.4			
V <sub>BSUV+</sub>	V <sub>BS</sub> supply undervoltage positive going threshold	7.5	8.6	9.7			
V <sub>BSUV-</sub>	V <sub>BS</sub> supply undervoltage negative going threshold	7.0	8.2	9.4			
V <sub>DDUV+</sub>	V <sub>DD</sub> supply undervoltage positive going threshold	3.3	4.1	4.9			
V <sub>DDUV-</sub>	V <sub>DD</sub> supply undervoltage negative going threshold	2.9	3.7	4.5			
I <sub>LKVCC</sub> I <sub>LKVBS</sub>	Offset supply leakage current – both input well and output well	---	---	50	μA	V <sub>B</sub> = V <sub>S</sub> = 600 V V <sub>CC</sub> = V <sub>COM</sub> = 600 V	
I <sub>QBS</sub>	Quiescent V <sub>BS</sub> supply current	---	70	140		V <sub>IN</sub> = 0 V or 5 V	
I <sub>QDD</sub>	Quiescent V <sub>DD</sub> supply current	---	140	280			
I <sub>QCC</sub>	Quiescent V <sub>CC</sub> supply current	---	200	400			
V <sub>IH</sub>	Logic “1” input voltage	3.5	---	---	V		
V <sub>IL</sub>	Logic “0” input voltage	---	---	0.6			
V <sub>OH</sub>	High level output voltage, V <sub>BIAS</sub> -V <sub>O</sub>	---	---	0.1			I <sub>o</sub> = 0 A
V <sub>OL</sub>	Low level output voltage, V <sub>O</sub>	---	---	0.1			I <sub>o</sub> = 0 A
I <sub>IN+</sub>	Logic “1” input bias current	---	2	10	μA	V <sub>IN</sub> = 5 V	
I <sub>IN-</sub>	Logic “0” input bias current	---	---	5		V <sub>IN</sub> = 0 V	
I <sub>o+</sub>	Output high short circuit pulsed current	---	0.5	---	A	V <sub>O</sub> =0 V, V <sub>IN</sub> =0 V, PW<=10 μs	
I <sub>o-</sub>	Output low short circuit pulsed current	---	0.5	---		V <sub>O</sub> =15 V, V <sub>IN</sub> =5 V, PW<=10 μs	

**Dynamic Electrical Characteristics (All values are target data)**

(VB-VS)= 15 V. CL = 1000 pF unless otherwise specified. All parameters are reference to COM. TA = 25 °C unless otherwise specified.

Symbol	Definition	Min	Typ	Max	Units	Test Conditions
t <sub>on</sub>	Turn-on propagation delay of high and low side	---	330	---	ns	V <sub>SS</sub> =200 V, V <sub>S</sub> =0 V
t <sub>off</sub>	Turn-off propagation delay of high and low side	---	330	---		V <sub>SS</sub> =200 V, V <sub>S</sub> =400 V
t <sub>r</sub>	Turn-on rise time of high and low side	---	25	70		V <sub>SS</sub> =200 V, V <sub>S</sub> =0 V
t <sub>f</sub>	Turn-off fall time of high and low side	---	25	70		V <sub>SS</sub> =200 V, V <sub>S</sub> =400 V
MT <sub>on</sub>	Turn on propagation delay matching	---	---	50		V <sub>SS</sub> =200 V, V <sub>S</sub> =0 V
MT <sub>off</sub>	Turn off propagation delay matching	---	---	50		V <sub>SS</sub> =200 V, V <sub>S</sub> =400 V

**Functional Block Diagram**

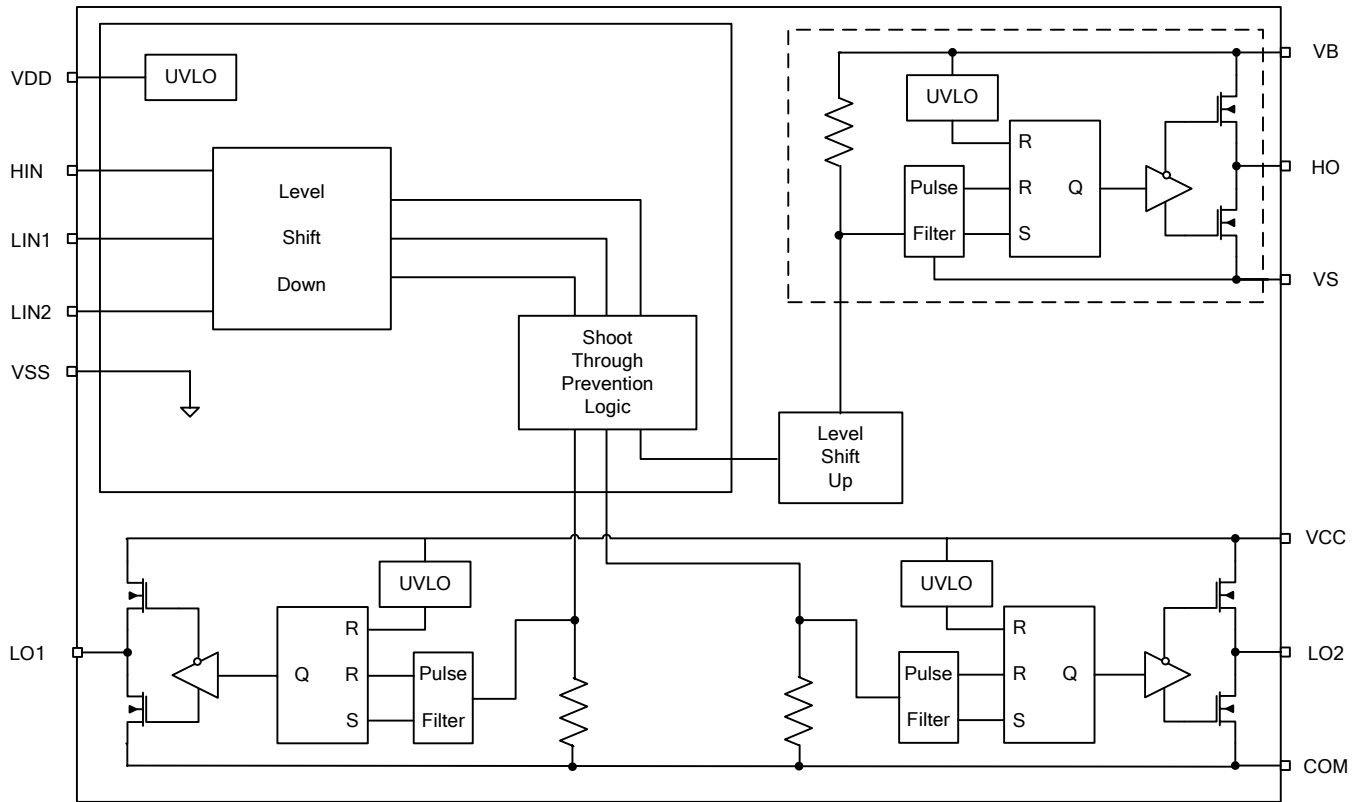

**Lead Definitions**

Symbol	Description
VDD	Input logic supply voltage
HIN	Logic input for high side gate driver
LIN1, LIN2	Logic inputs for low side gate driver
VSS	Input logic supply return
LO1, LO2	Low side outputs
VCC	Low side supply voltage
COM	Low side supply return
HO	High side output
VB	High side floating supply voltage
VS	High side floating supply return

**Lead Assignments**

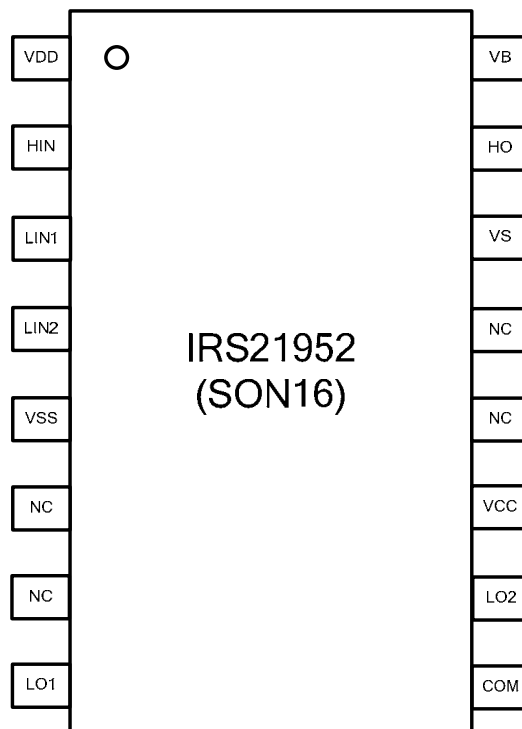

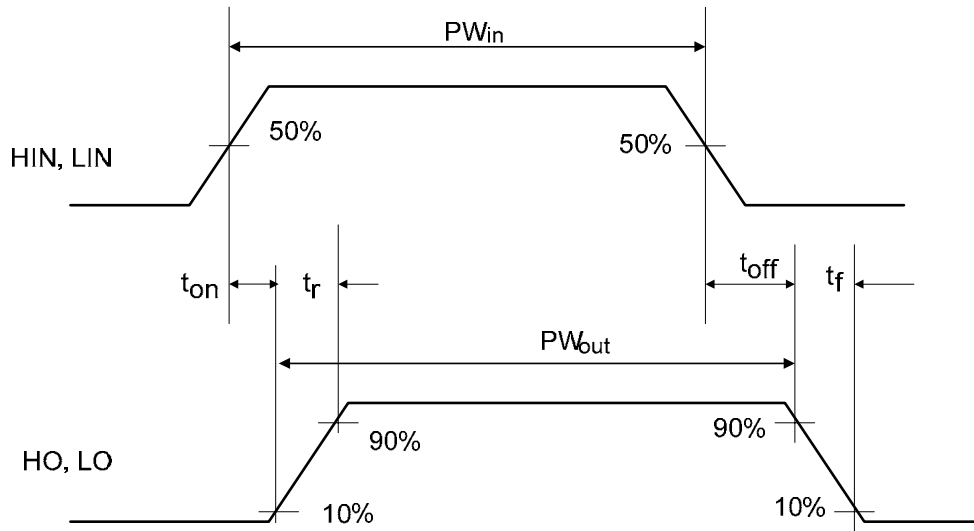
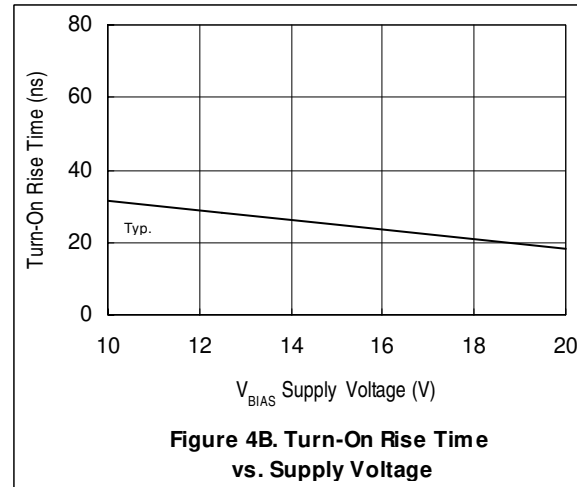
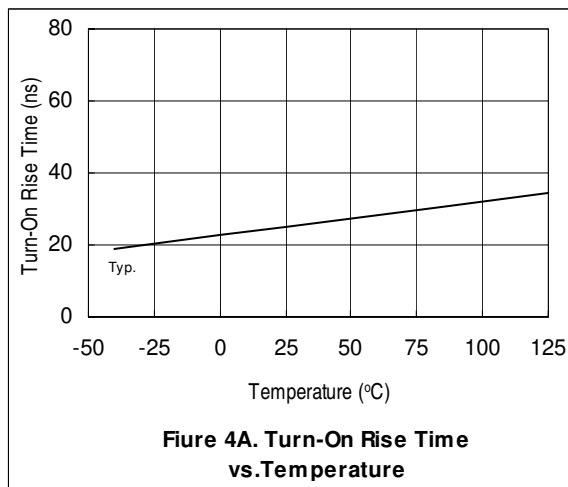
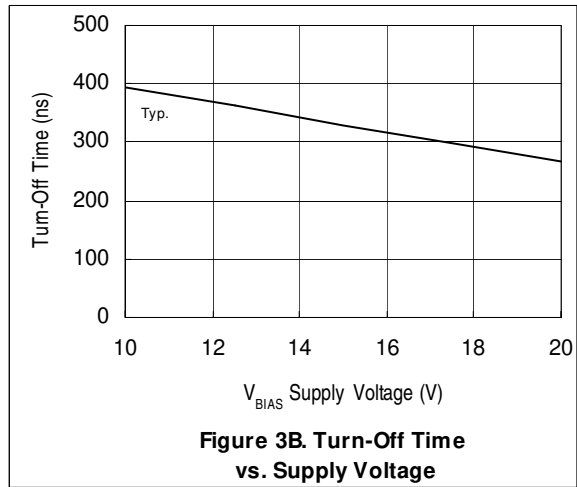
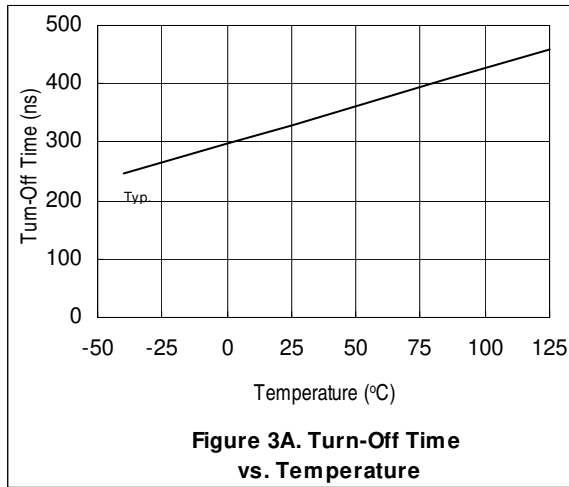
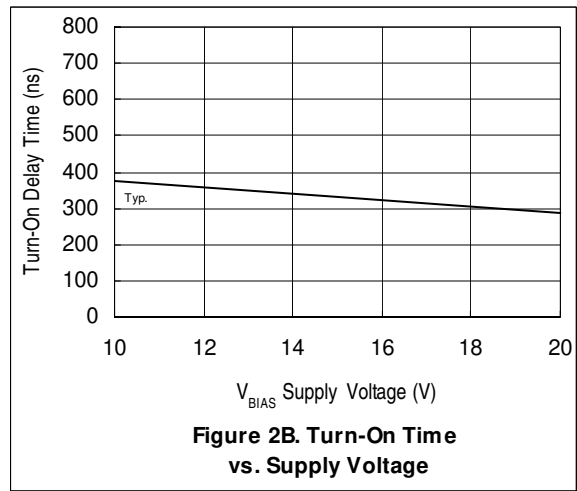
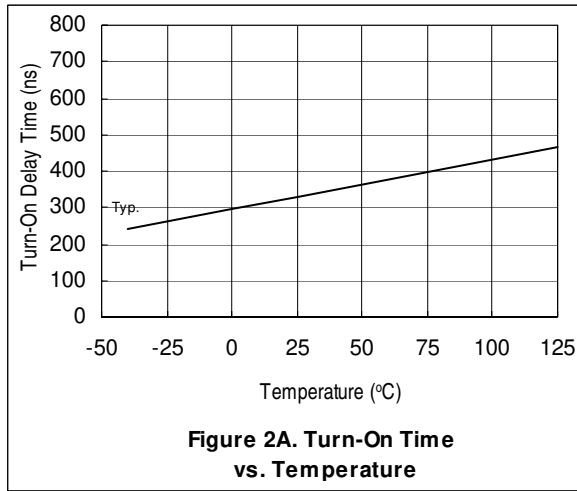

Figure 1: Switching Time Waveforms

### Shoot Through Prevention Logic

HIN1	LIN1	LIN2	HO1	LO1	LO2
1	0	0	1	0	0
0	1	0	0	1	0
0	0	1	0	0	1
1	1	0	0	0	0
1	0	1	0	0	0
0	1	1	0	1	1
1	1	1	0	0	0
0	0	0	0	0	0





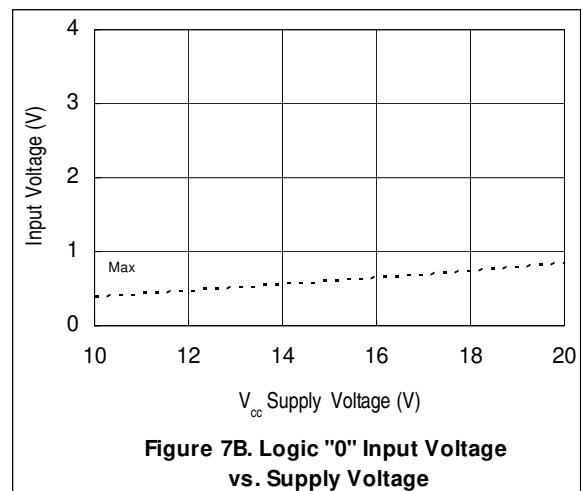
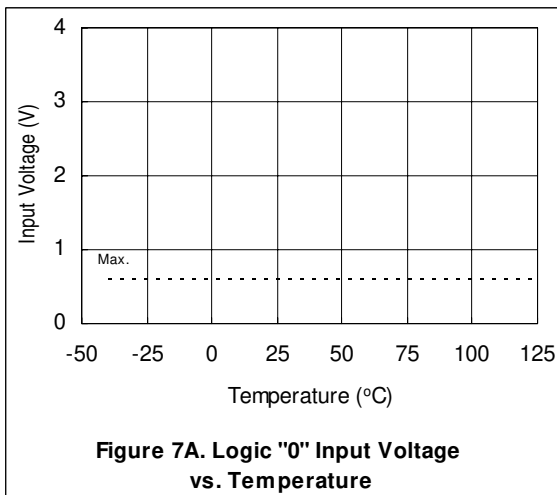
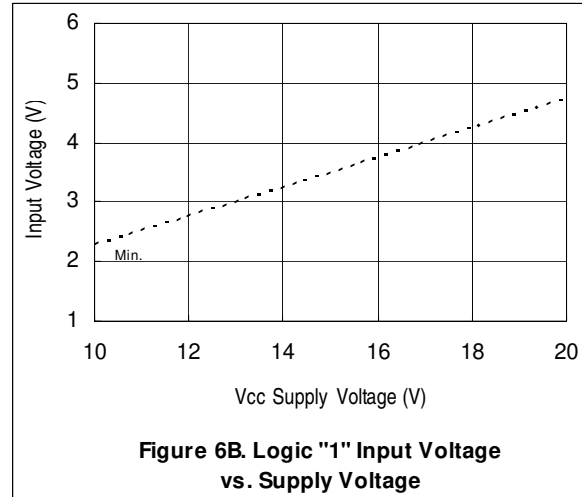
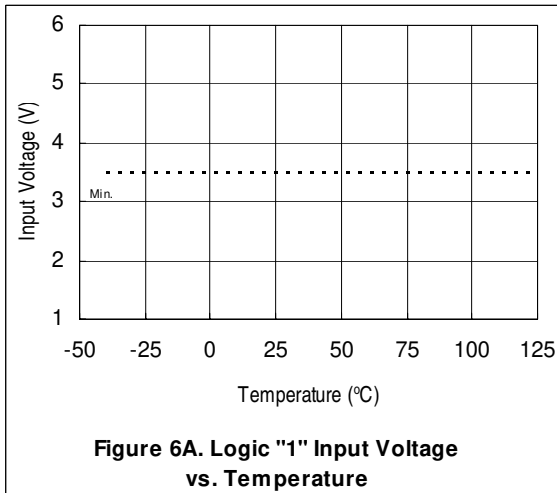
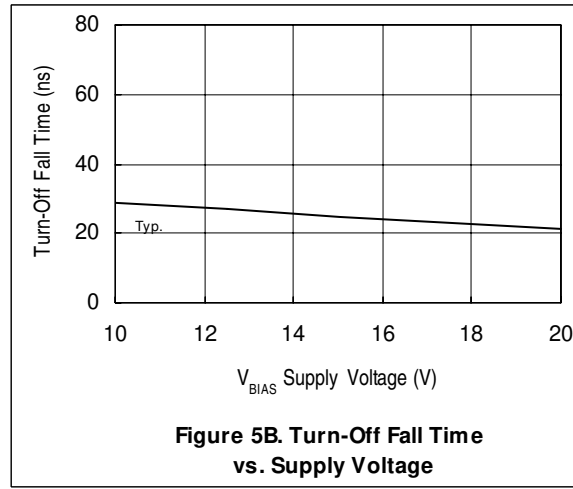
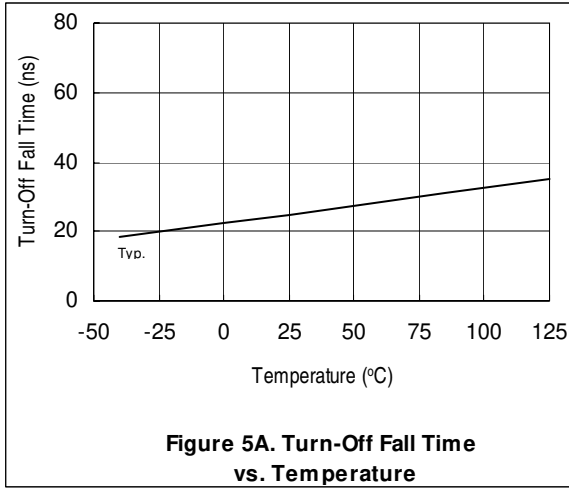

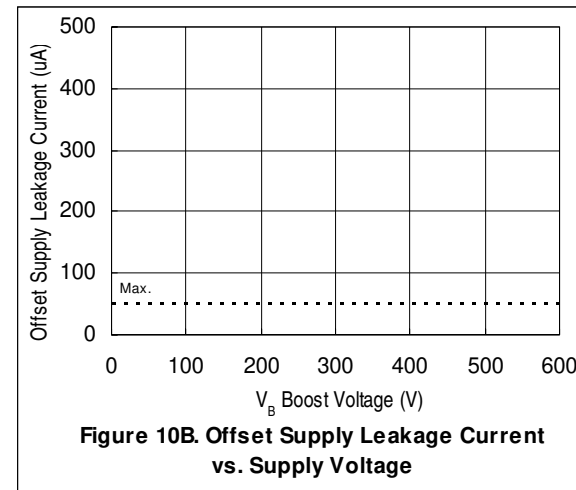
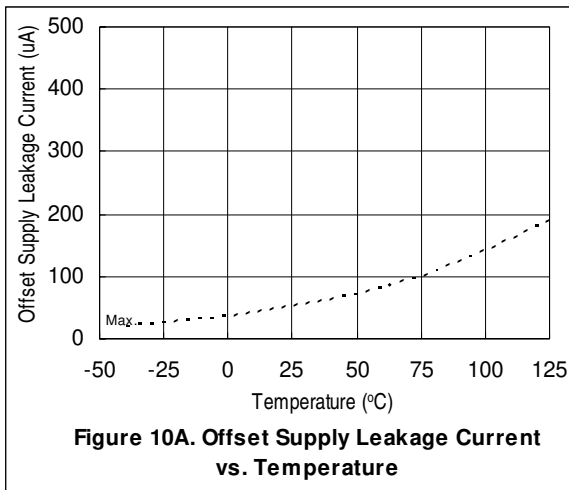
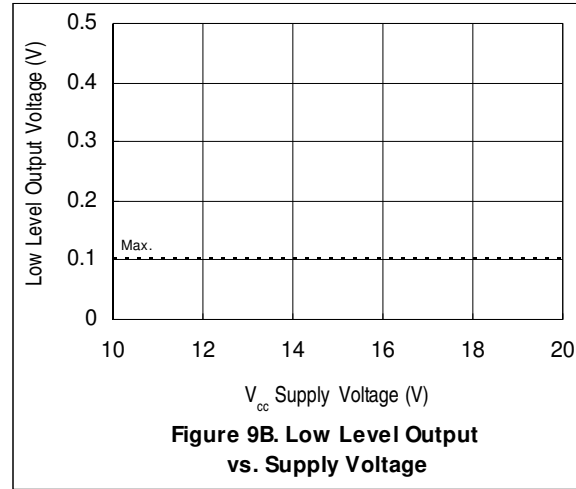
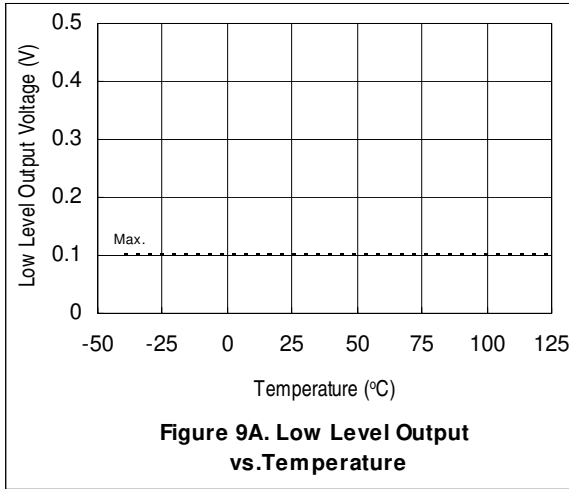
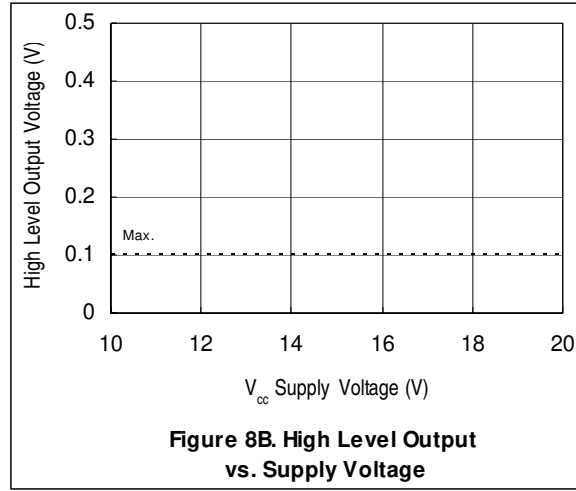
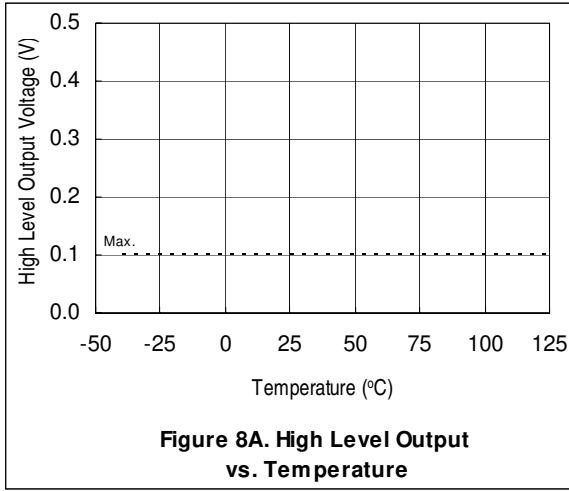

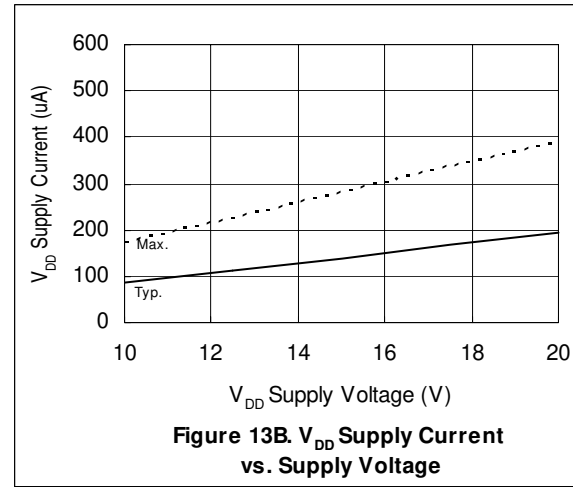
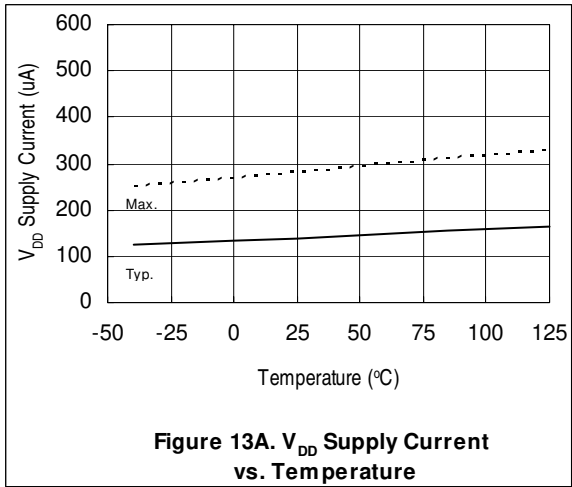
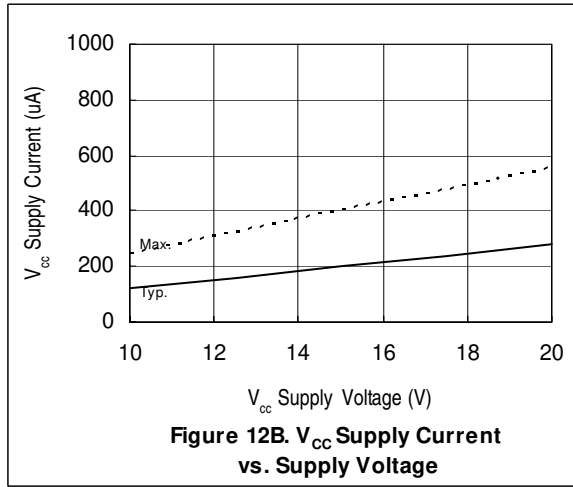
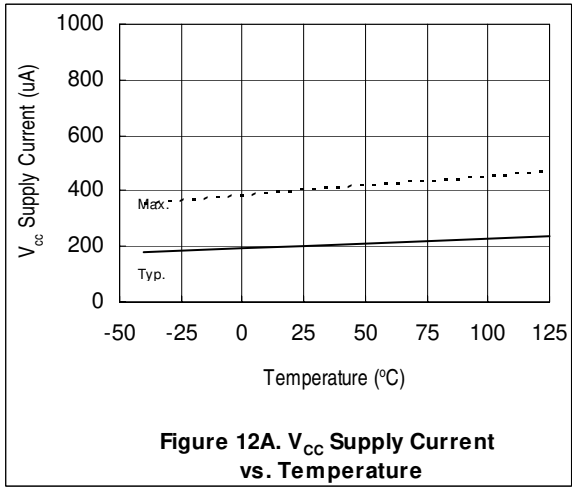
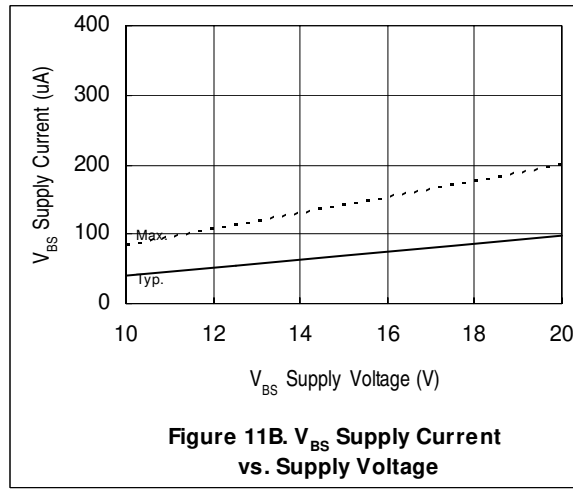
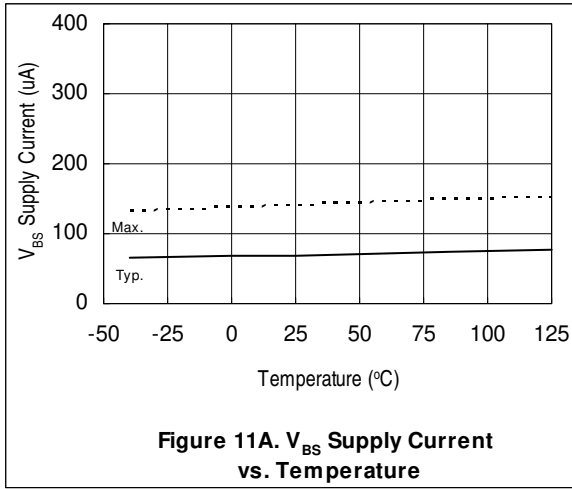

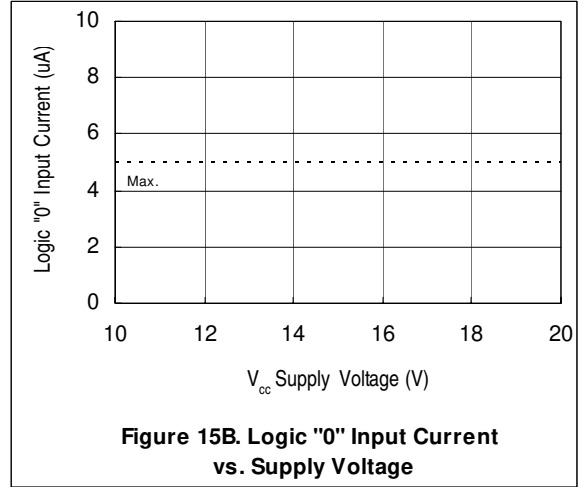
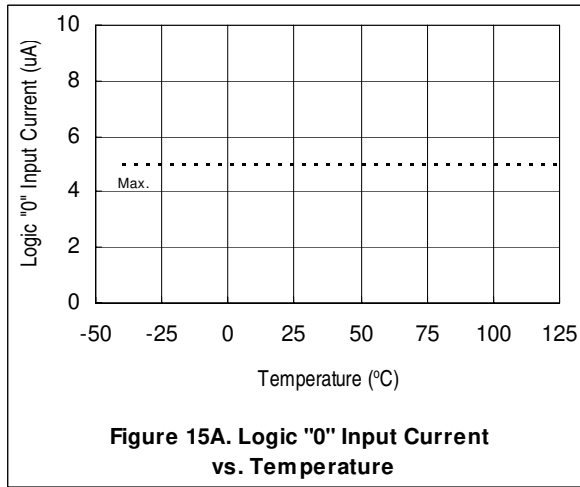
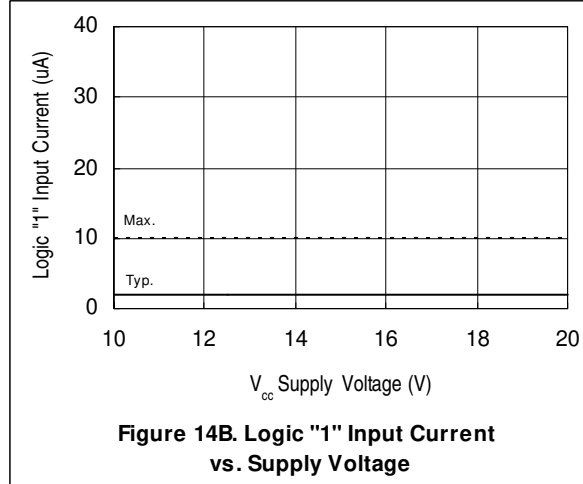
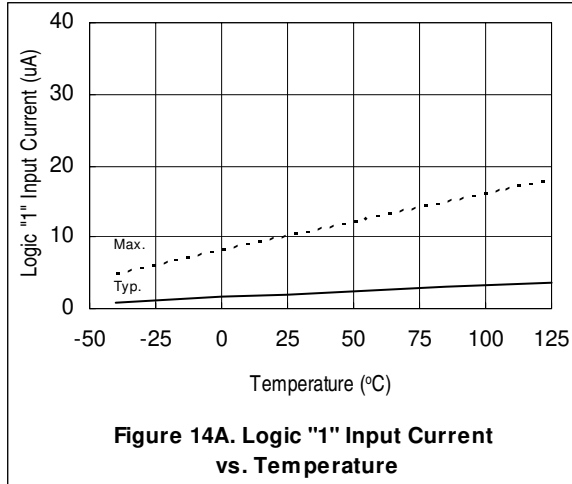

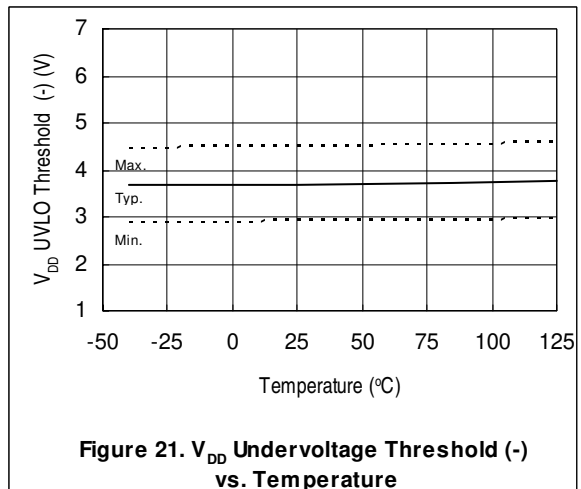
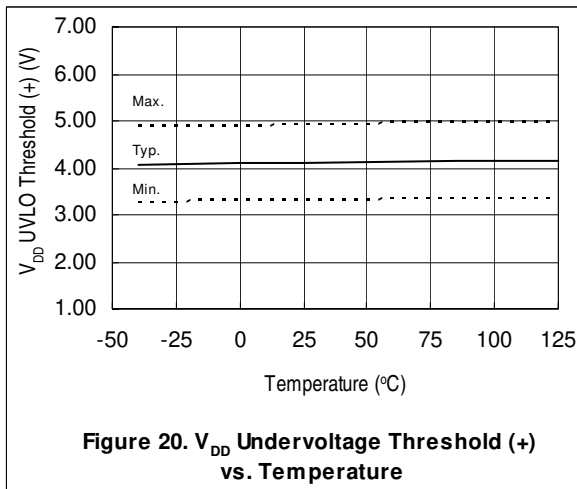
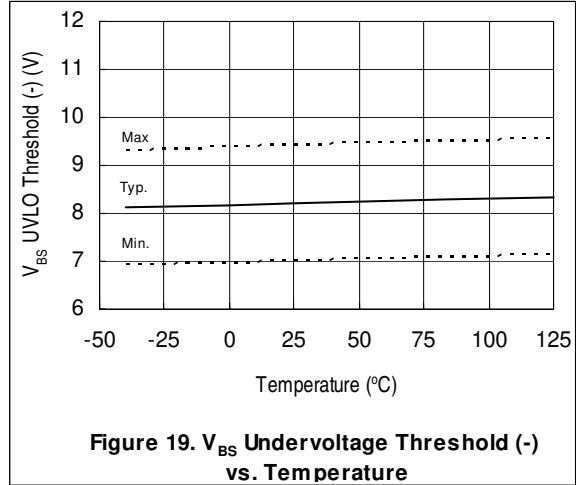
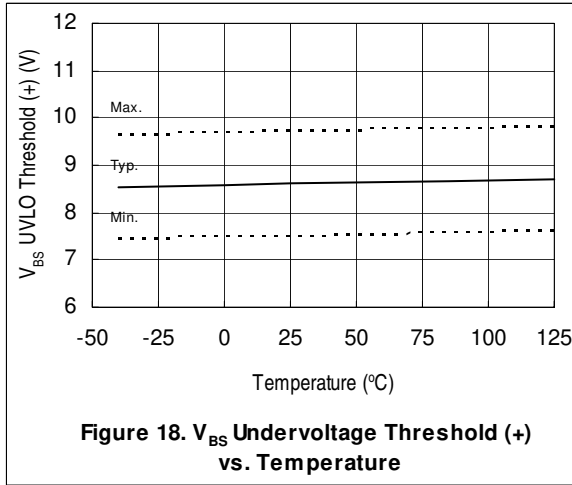
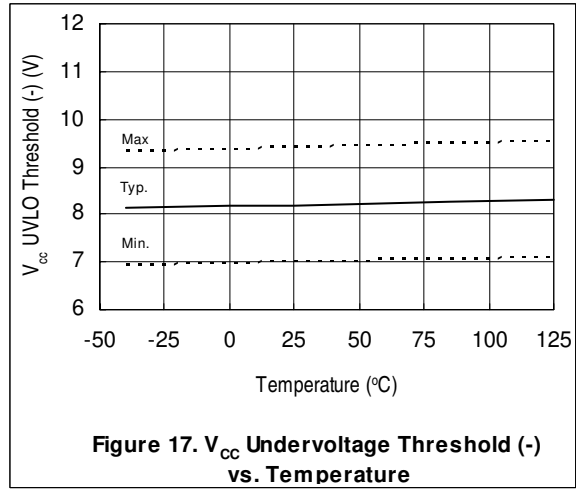
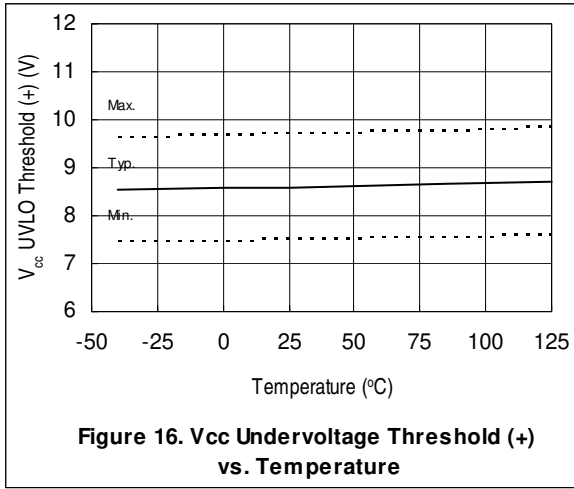

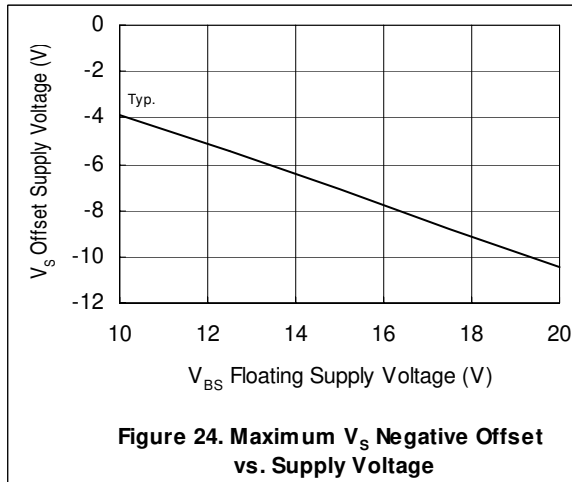
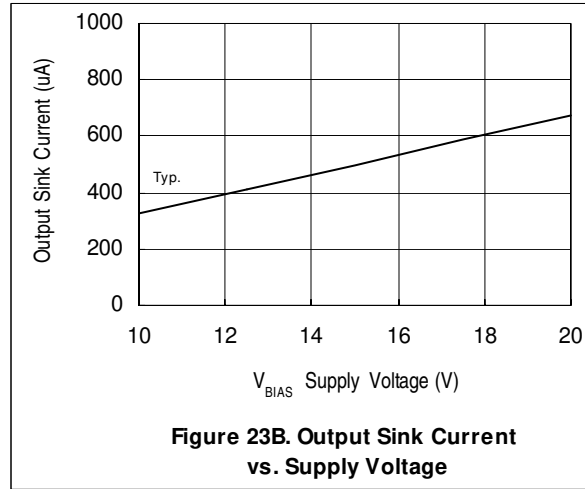
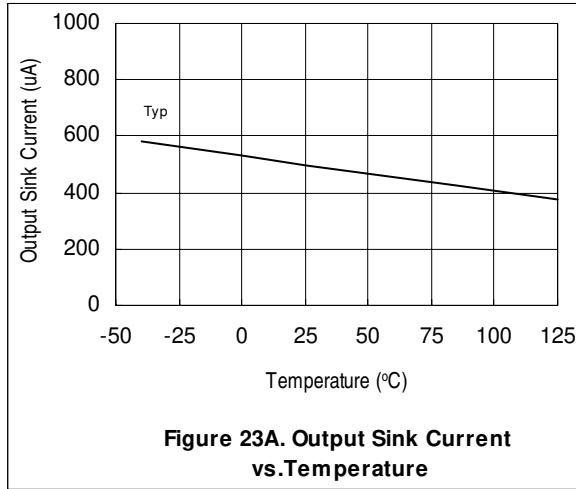
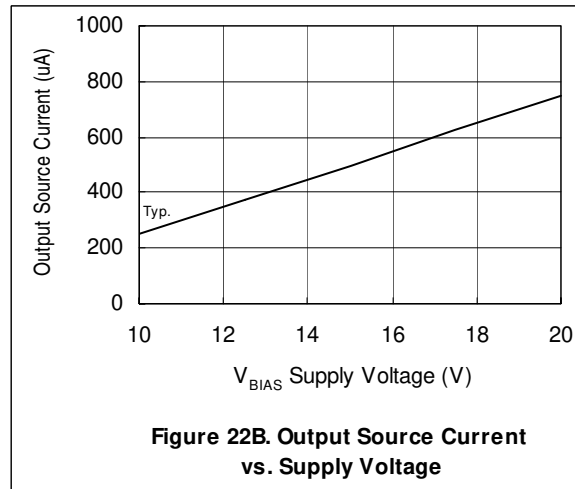
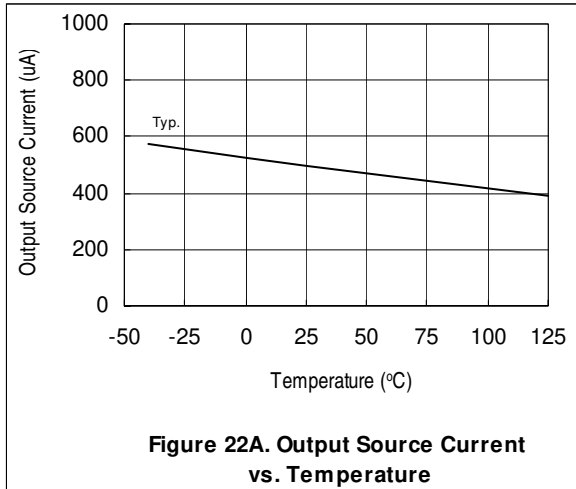

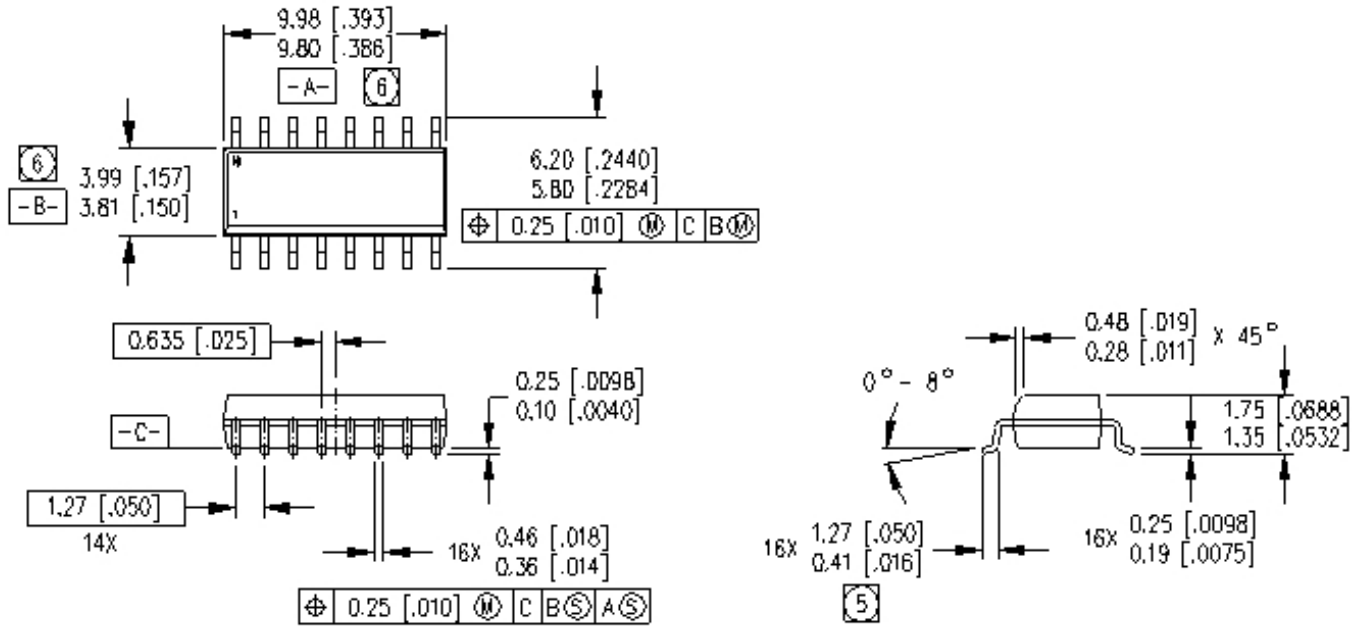

NOTES:

1. DIMENSIONING & TOLERANCING PER ANSI Y14.5W-1982
2. CONTROLLING DIMENSION. MILLIMETER
3. DIMENSIONS ARE SHOWN IN MILLIMETER [INCHES]
4. OUTLINE CONFORMS TO JEDEC OUTLINE MS-012AC
5. DIMENSION IS THE LENGTH OF LEAD FOR SOLDERING TO A SUBSTRATE
6. DIMENSION DOES NOT INCLUDE MOLD PROTUSIONS. MOLD PROTUSIONS SHALL NOT EXCEED 0.15 [.006]

**16-Lead SOIC (narrow body)**



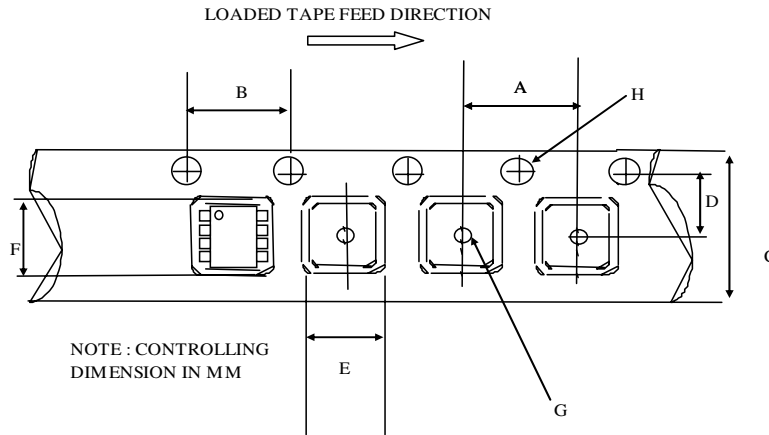

CARRIER TAPE DIMENSION FOR 16SOICN

Code	Metric		Imperial	
	Min	Max	Min	Max
A	7.90	8.10	0.311	0.318
B	3.90	4.10	0.153	0.161
C	15.70	16.30	0.618	0.641
D	7.40	7.60	0.291	0.299
E	6.40	6.60	0.252	0.260
F	10.20	10.40	0.402	0.409
G	1.50	n/a	0.059	n/a
H	1.50	1.60	0.059	0.062

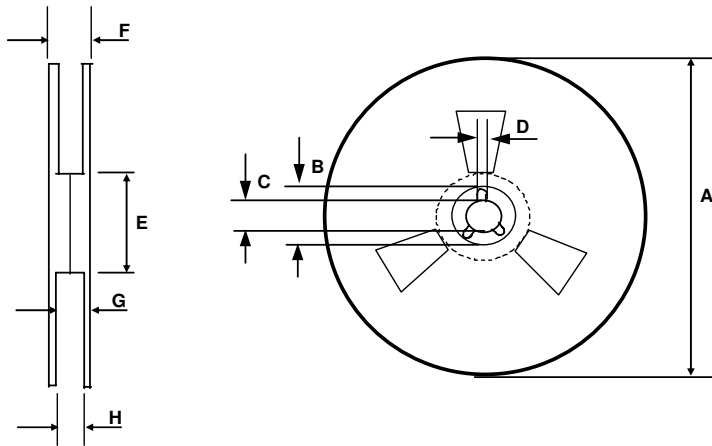

REEL DIMENSIONS FOR 16SOICN

Code	Metric		Imperial	
	Min	Max	Min	Max
A	329.60	330.25	12.976	13.001
B	20.95	21.45	0.824	0.844
C	12.80	13.20	0.503	0.519
D	1.95	2.45	0.767	0.096
E	98.00	102.00	3.858	4.015
F	n/a	22.40	n/a	0.881
G	18.50	21.10	0.728	0.830
H	16.40	18.40	0.645	0.724

**LEAD-FREE PART MARKING INFORMATION**

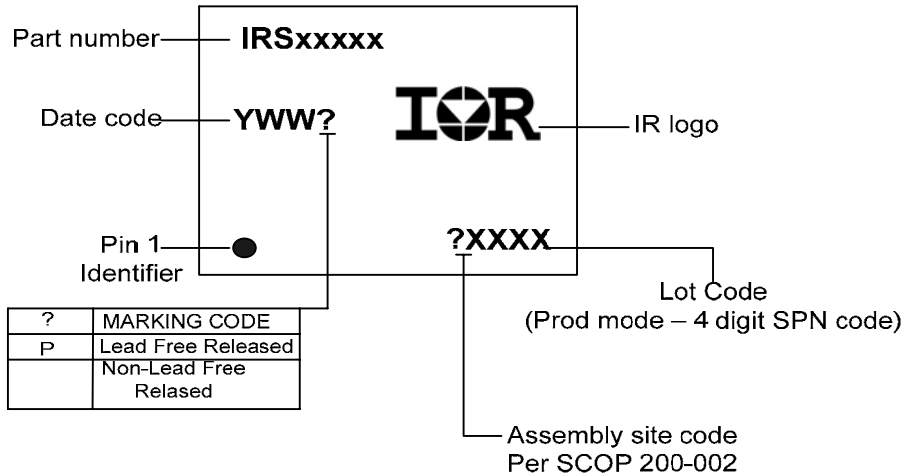

**ORDER INFORMATION**

16-Lead SOIC IRS21952SPBF

16-Lead SOIC Tape & Reel IRS21952STRPBF