



Chipsmall Limited consists of a professional team with an average of over 10 year of expertise in the distribution of electronic components. Based in Hongkong, we have already established firm and mutual-benefit business relationships with customers from,Europe,America and south Asia,supplying obsolete and hard-to-find components to meet their specific needs.

With the principle of "Quality Parts,Customers Priority,Honest Operation,and Considerate Service",our business mainly focus on the distribution of electronic components. Line cards we deal with include Microchip,ALPS,ROHM,Xilinx,Pulse,ON,Everlight and Freescale. Main products comprise IC,Modules,Potentiometer,IC Socket,Relay,Connector.Our parts cover such applications as commercial,industrial, and automotives areas.

We are looking forward to setting up business relationship with you and hope to provide you with the best service and solution. Let us make a better world for our industry!



Contact us

Tel: +86-755-8981 8866 Fax: +86-755-8427 6832

Email & Skype: info@chipsmall.com Web: www.chipsmall.com

Address: A1208, Overseas Decoration Building, #122 Zhenhua RD., Futian, Shenzhen, China



IS31AP4915

20V_{P-P} CHARGE PUMP CERAMIC SPEAKER DRIVER

September 2012

GENERAL DESCRIPTION

The IS31AP4915 features a mono power amplifier with an integrated charge-pump power supply specifically designed to drive the high capacitance of a ceramic loudspeaker.

The IS31AP4915 maximizes battery life by offering high performance efficiency.

The IS31AP4915 is ideally suited to deliver the high output-voltage swing required to drive ceramic/piezoelectric speakers.

The device utilizes comprehensive click-and-pop suppression and shutdown control. The IS31AP4915 is fully specified over the -40°C to +85°C extended temperature range and is available in small lead-free 16-pin QFN (4mm × 4mm) packages.

FEATURES

- Integrated charge-pump power supply - no inductor required
- Thermal protection
- Pop reduction circuitry
- 20V_{P-P} voltage swing into piezoelectric speaker
- QFN-16, 4mm × 4mm

APPLICATIONS

- CD/MP3 players
- Smart phones
- Cellular phones
- PDAs
- Handheld gaming

TYPICAL APPLICATION CIRCUIT

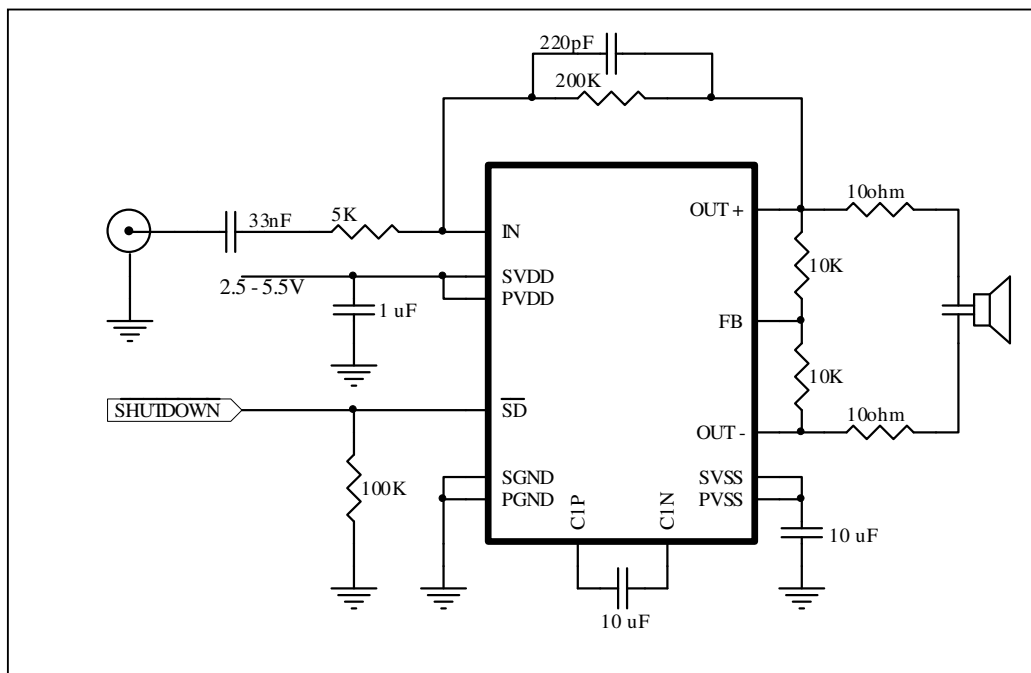
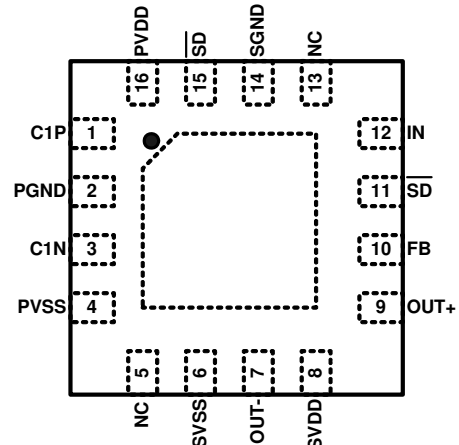

Figure 1 Typical Application Circuit

IS31AP4915

PIN CONFIGURATION

Package	Pin Configuration (Top View)
QFN-16	

PIN DESCRIPTION

No.	Pin	Description
1	C1P	Charge pump flying capacitor positive terminal.
2	PGND	Power ground, connect to ground.
3	C1N	Charge pump flying capacitor negative terminal.
4	PVSS	Output from charge pump.
5, 13	NC	No connection.
6	SVSS	Amplifier negative supply, connect to PVSS.
7	OUT-	Negative output signal.
8	SVDD	Amplifier positive supply, connect to PVDD.
9	OUT+	Positive output signal.
10	FB	Feed back.
11, 15	\overline{SD}	Shutdown, active low logic.
12	IN	Audio input signal.
14	SGND	Signal ground, connect to ground.
16	PVDD	Charge pump supply voltage, connect to positive supply.
	Thermal Pad	Connect to GND.

Copyright © 2012 Integrated Silicon Solution, Inc. All rights reserved. ISSI reserves the right to make changes to this specification and its products at any time without notice. ISSI assumes no liability arising out of the application or use of any information, products or services described herein. Customers are advised to obtain the latest version of this device specification before relying on any published information and before placing orders for products. Integrated Silicon Solution, Inc. does not recommend the use of any of its products in life support applications where the failure or malfunction of the product can reasonably be expected to cause failure of the life support system or to significantly affect its safety or effectiveness. Products are not authorized for use in such applications unless Integrated Silicon Solution, Inc. receives written assurance to its satisfaction, that:

- the risk of injury or damage has been minimized;
- the user assume all such risks; and
- potential liability of Integrated Silicon Solution, Inc is adequately protected under the circumstances



IS31AP4915

ORDERING INFORMATION

Industrial Range: -40°C to +85°C

Order Part No.	Package	QTY/Reel
IS31AP4915-QFLS2-TR	QFN-16, Lead-free	3000

IS31AP4915

ABSOLUTE MAXIMUM RATINGS

Supply voltage, V_{DD}	-0.3V ~ +6.5V
Voltage at any input pin	-0.3V ~ $V_{DD}+0.3V$
Maximum junction temperature, T_{JMAX}	150°C
Storage temperature range, T_{STG}	-65°C ~ +150°C
Operating temperature range, T_A	-40°C ~ +85°C

Note:

Stresses beyond those listed under "Absolute Maximum Ratings" may cause permanent damage to the device. These are stress ratings only and functional operation of the device at these or any other condition beyond those indicated in the operational sections of the specifications is not implied. Exposure to absolute maximum rating conditions for extended periods may affect device reliability.

RECOMMENDED OPERATING CONDITIONS

Symbol	Parameter	Min.	Max.	Unit
SV_{DD}, PV_{DD}	Supply voltage	2.5	6.5	V
V_{IH}	High level input voltage	1.5		V
V_{IL}	Low level input voltage		0.5	V

ELECTRICAL CHARACTERISTICS

$T_A=25^\circ\text{C}$. (Note 1)

Symbol	Parameter	Condition	Min.	Typ.	Max.	Unit
$ V_{OS} $	Output Offset Voltage			6		mV
I_{DD}	Supply Current	$V_{DD} = 3V, \overline{SD} = V_{DD}$		6.0	8.0	mA
		$V_{DD} = 5V, \overline{SD} = V_{DD}$		8.5	10.5	
		Shutdown mode, $V_{DD} = 2.5V \sim 6.5V$				1

ELECTRICAL CHARACTERISTICS

$V_{DD} = 3.6V, T_A = 25^\circ\text{C}$ (unless otherwise noted) (Note 2)

Symbol	Parameter	Condition	Min.	Typ.	Max.	Unit
V_{OUT}	Output voltage	$f = 1\text{kHz}$	$V_{CC} = 5V$		7.9	V_{RMS}
		THD+N = 10%	$V_{CC} = 3.6V$		5.7	
		$Z_L = 1\mu\text{F}+10\Omega$	$V_{CC} = 2.7V$		4.3	
THD+N	Total harmonic distortion plus noise	$Z_L = 1\mu\text{F}+10\Omega, V_{OUT} = 1\text{kHz}/2V_{RMS}$		0.01		%
		$Z_L = 1\mu\text{F}+10\Omega, V_{OUT} = 1\text{kHz}/4V_{RMS}$		0.01		
V_n	Noise output voltage			10		μV_{RMS}
f_{osc}	Charge pump switching frequency			320		kHz
t_{ON}	Start-up time from shutdown			450		μs
SNR	Signal-to-noise ratio			100		dB
	Thermal shutdown	Threshold		160		$^\circ\text{C}$
		Hysteresis		15		$^\circ\text{C}$

Note 1: Production testing of the device is performed at 25°C. Functional operation of the device and parameters specified over other temperature range, are guaranteed by design, characterization and process control.

Note 2: Guaranteed by design.

TYPICAL OPERATING CHARACTERISTICS

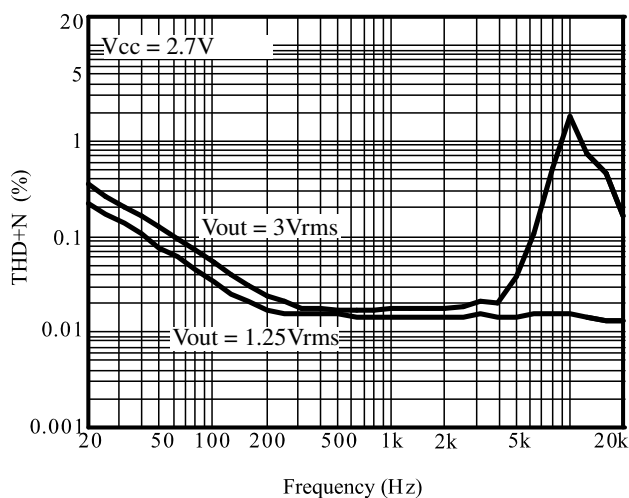

Figure 2 THD+N vs. Frequency($R_L = 1\mu F + 10\Omega$)

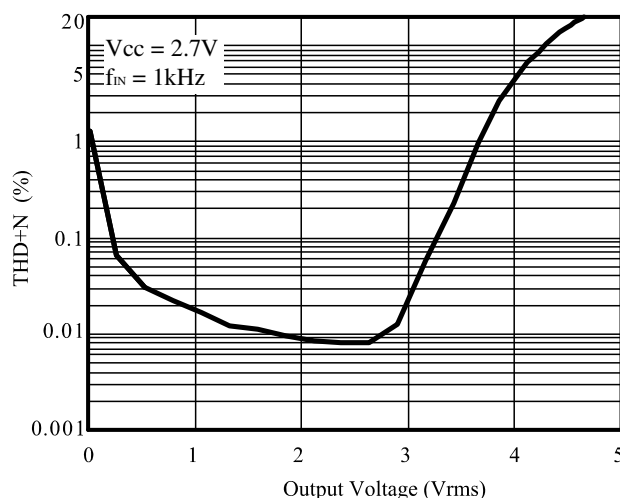

Figure 3 THD+N vs. Output Voltage($R_L = 1\mu F + 10\Omega$)

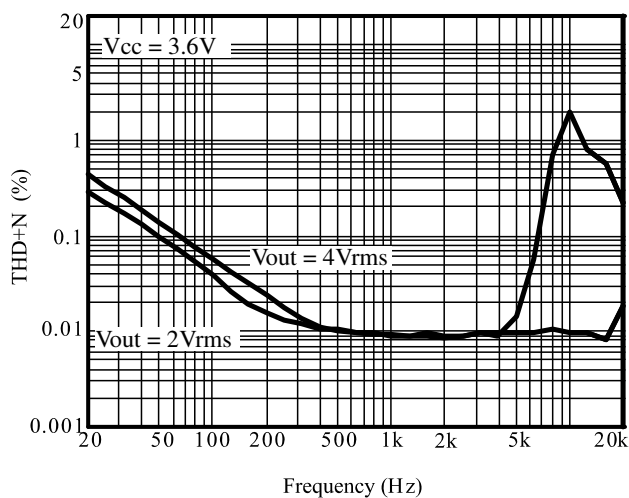

Figure 4 THD+N vs. Frequency($R_L = 1\mu F + 10\Omega$)

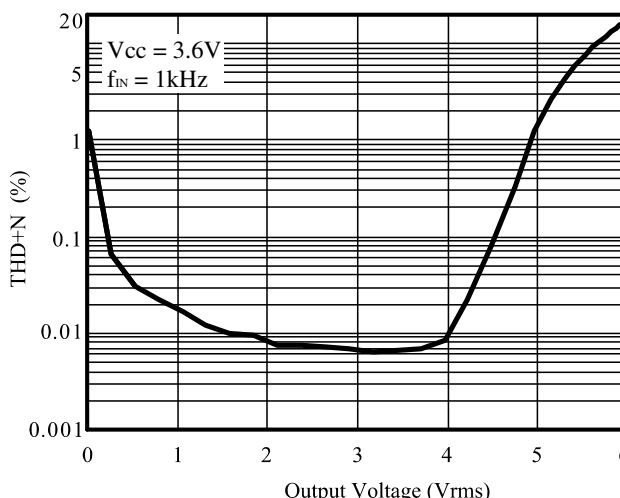

Figure 5 THD+N vs. Output Voltage($R_L = 1\mu F + 10\Omega$)

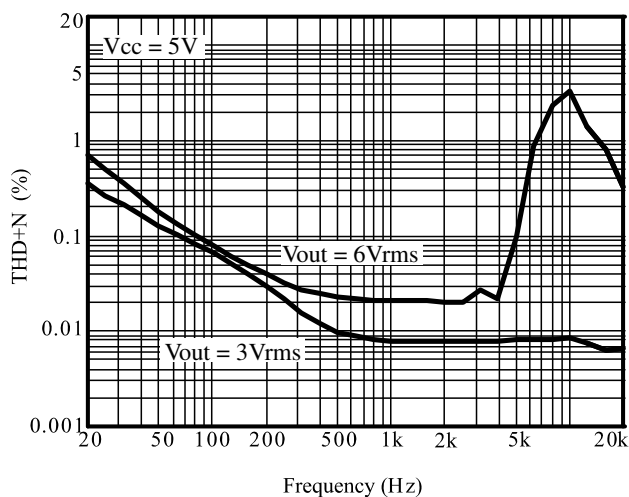

Figure 6 THD+N vs. Frequency($R_L = 1\mu F + 10\Omega$)

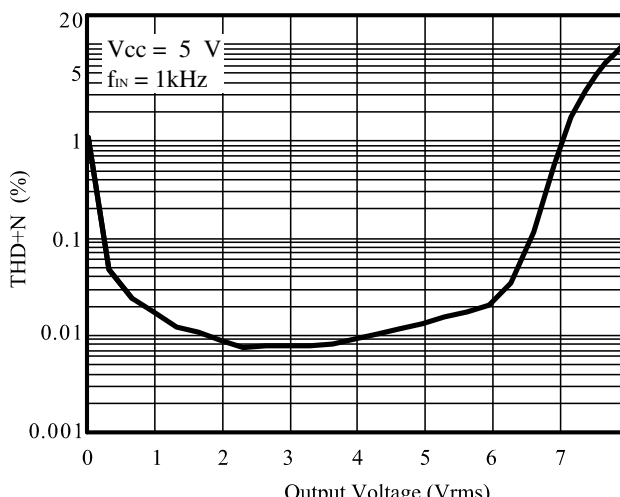

Figure 7 THD+N vs. Output Voltage($R_L = 1\mu F + 10\Omega$)

IS31AP4915

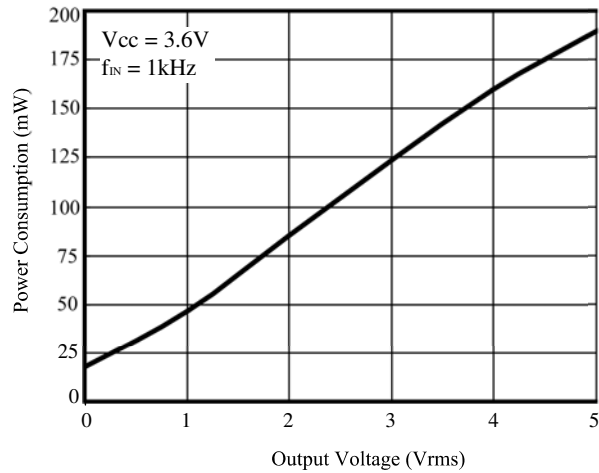

Figure 8 Power Consumption vs. Output Voltage($R_L = 1\mu F + 10\Omega$)

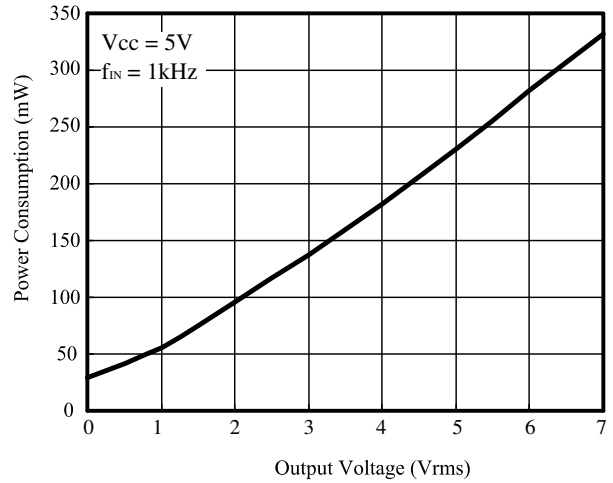

Figure 9 Power Consumption vs. Output Voltage($R_L = 1\mu F + 10\Omega$)

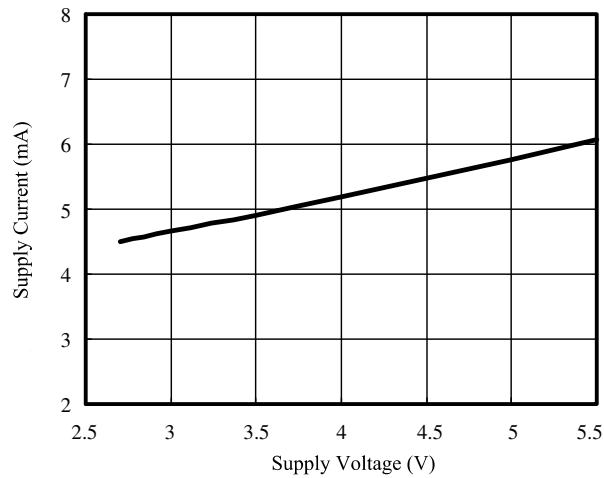

Figure 10 Supply Current vs. Supply Voltage($R_L = 1\mu F + 10\Omega$)

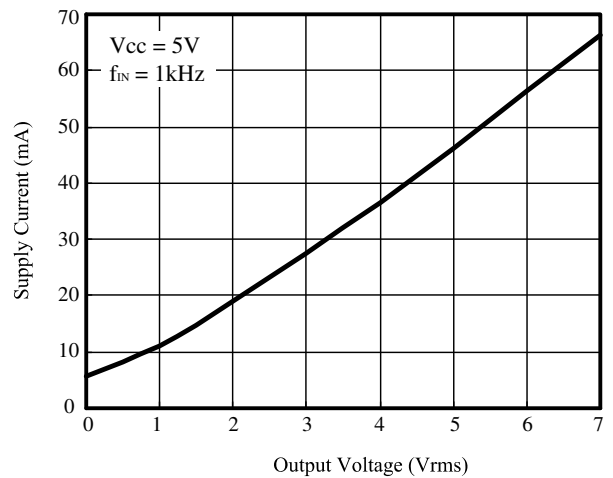
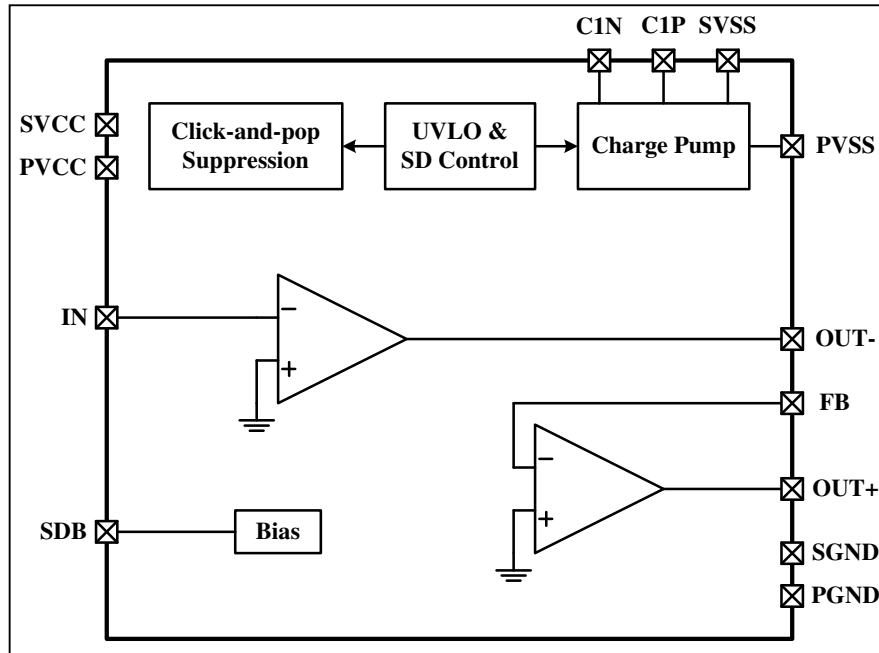

Figure 11 Supply Current vs. Output Voltage($R_L = 1\mu F + 10\Omega$)

IS31AP4915

FUNCTIONAL BLOCK DIAGRAM



IS31AP4915

APPLICATION INFORMATION

INPUT-BLOCKING CAPACITORS

DC input-blocking capacitors are required to be added in series with the audio signal into the input pin of the IS31AP4915. This capacitor blocks the DC portion of the audio source and allows the IS31AP4915 inputs to be properly biased to provide maximum performance.

These capacitors form a high-pass filter with the input impedance of the IS31AP4915. The cutoff frequency is calculated using Equation 1. For this calculation, the capacitance used is the input-blocking capacitor and the resistance is the input impedance of the IS31AP4915. Because the gains of both the IS31AP4915 are fixed, the input impedance remains a constant value. Using the input impedance value from the operating characteristics table, the frequency and/or capacitance can be determined when one of the two values is given.

$$f_{c_{IN}} = \frac{1}{2\pi R_{IN} C_{IN}} \quad \text{or} \quad C_{IN} = \frac{1}{2\pi f_{c_{IN}} R_{IN}} \quad (1)$$

CHARGE PUMP FLYING CAPACITOR AND PVSS CAPACITOR

The charge pump flying capacitor serves to transfer charge during the generation of the negative supply voltage. The PVSS capacitor must be at least equal to the charge pump capacitor in order to allow maximum charge transfer. Low ESR capacitors are an ideal selection, and a value of 10 μ F is typical. Capacitor values that are smaller than 10 μ F can be used, but the maximum output power is reduced and the device may not operate to specifications.

DECOUPLING CAPACITORS

The IS31AP4915 require adequate power supply decoupling to ensure that the noise and total harmonic distortion (THD) are low. A good low equivalent-series-resistance (ESR) ceramic capacitor, typically 1 μ F, placed as close as possible to the device V_{DD} lead works best. Placing this decoupling capacitor close to the IS31AP4915 is important for the performance of the amplifier. For filtering lower frequency noise signals, a 10 μ F or greater capacitor placed near the audio power amplifier would also help, but it is not required in most applications because of the high PSRR of this device.

LAYOUT RECOMMENDATIONS

The SGND and PGND pins of the IS31AP4915 must be routed separately back to the decoupling capacitor in order to provide proper device operation. If the SGND and PGND pins are connected directly to each other, the part functions without risk of failure, but the noise and THD performance do not meet the specifications.

IS31AP4915

CLASSIFICATION REFLOW PROFILES

Profile Feature	Pb-Free Assembly
Preheat & Soak	
Temperature min (T _{smin})	150°C
Temperature max (T _{smax})	200°C
Time (T _{smin} to T _{smax}) (t _s)	60-120 seconds
Average ramp-up rate (T _{smax} to T _p)	3°C/second max.
Liquidous temperature (T _L)	217°C
Time at liquidous (t _L)	60-150 seconds
Peak package body temperature (T _p)*	Max 260°C
Time (t _p)** within 5°C of the specified classification temperature (T _c)	Max 30 seconds
Average ramp-down rate (T _p to T _{smax})	6°C/second max.
Time 25°C to peak temperature	8 minutes max.

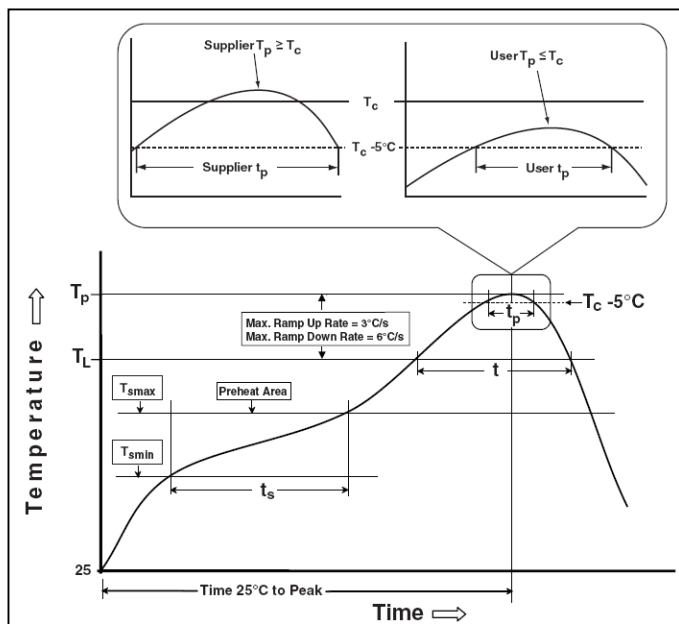
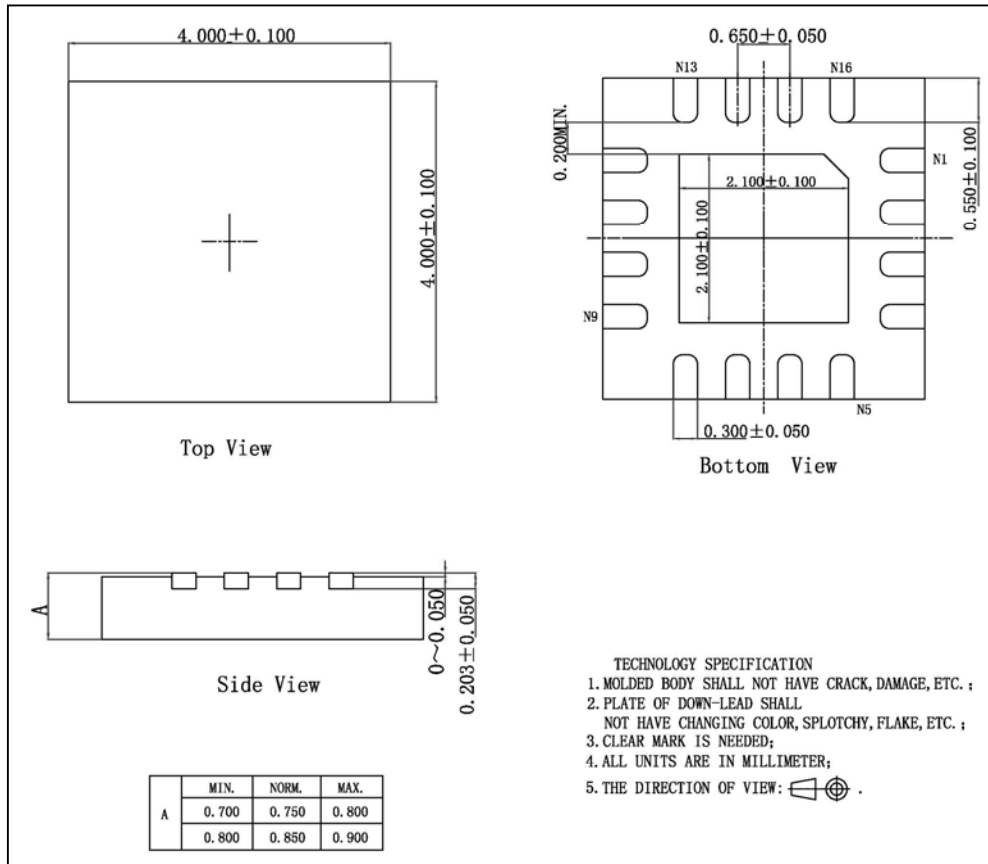

Figure 12 Classification Profile

IS31AP4915

PACKAGE INFORMATION

QFN-16



Note: All dimensions in millimeters unless otherwise stated.