



Chipsmall Limited consists of a professional team with an average of over 10 year of expertise in the distribution of electronic components. Based in Hongkong, we have already established firm and mutual-benefit business relationships with customers from,Europe,America and south Asia,supplying obsolete and hard-to-find components to meet their specific needs.

With the principle of “Quality Parts,Customers Priority,Honest Operation,and Considerate Service”,our business mainly focus on the distribution of electronic components. Line cards we deal with include Microchip,ALPS,ROHM,Xilinx,Pulse,ON,Everlight and Freescale. Main products comprise IC,Modules,Potentiometer,IC Socket,Relay,Connector.Our parts cover such applications as commercial,industrial, and automotives areas.

We are looking forward to setting up business relationship with you and hope to provide you with the best service and solution. Let us make a better world for our industry!



Contact us

Tel: +86-755-8981 8866 Fax: +86-755-8427 6832

Email & Skype: info@chipsmall.com Web: www.chipsmall.com

Address: A1208, Overseas Decoration Building, #122 Zhenhua RD., Futian, Shenzhen, China



IS31BL3229

8-LED BACKLIGHT DRIVER

October 2012

GENERAL DESCRIPTION

The IS31BL3229 with a smart charge-pump circuit is a parallel white-LED driver with eight matched 20mA current outputs. It can supply a total output current of 160mA over an input voltage range of 2.7V to 5.5V.

IS31BL3229 typically draws less than 1 μ A when placed in shutdown, and 0.7mA when operating in the no-load and 1X mode condition. If any of the outputs are not used, leave the pin(s) unconnected. Brightness can be controlled by simple-series-control techniques and external PWM signal.

IS31BL3229 is available in QFN-20 (3mm \times 3mm). It operates from 2.7V to 5.5V over the temperature range of -40°C to +85°C.

FEATURES

- Supply voltage: 2.7V ~ 5.5V
- 1X, 1.5X operating mode
- fade in and fade out mode
- Output current can be 25mA
- 32 current level and PWM intensity control
- Low input current ripple, low EMI
- 90% high efficiency
- No inductors, low noise operation
- Over voltage protection on output
- Built-in thermal protection
- Automatic soft start
- Built-in thermal protection
- QFN-20 (3mm \times 3mm) package

APPLICATIONS

- Cell phone, smart phone, PDA
- Mp3, Mp4, PMP
- White LED backlighting

TYPICAL APPLICATION CIRCUIT

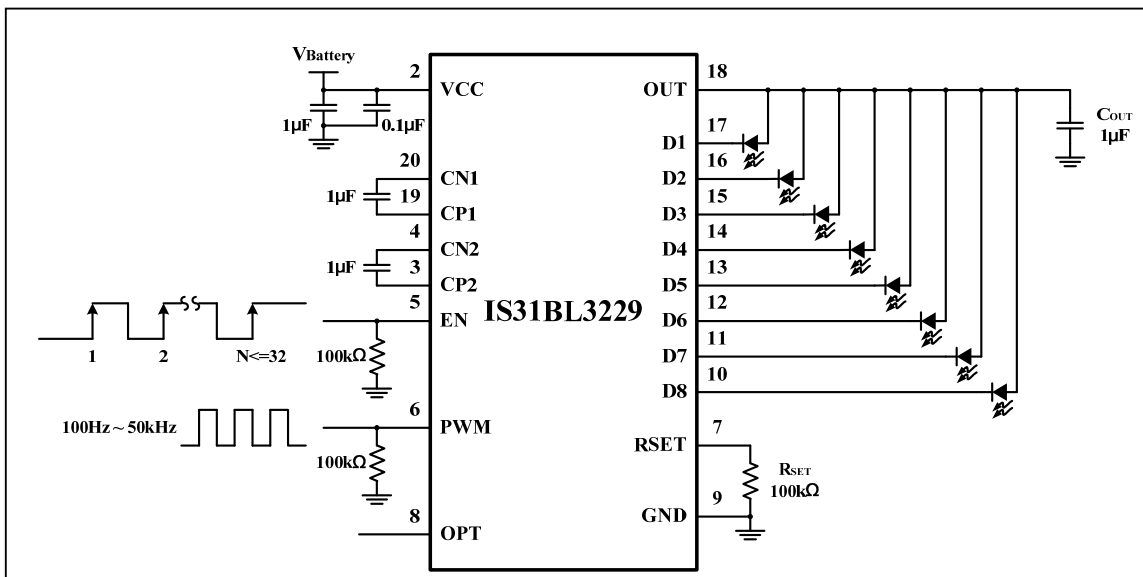

Figure 1 Typical Application Circuit

Note 1: PWM pin should be pulled high if modulated by EN pin only. EN pin should be pulled high if modulated with PWM pin only. Please refer to Page 8 for detail information.

Note 2: The fade in and fade out mode is only available when shut down and enable the IC by EN pin.

Note 3: D1 must be connected and others can be floating in less than 8 LEDs application.

Note 4: The IC should be placed far away from the mobile antenna in order to prevent the EMI.

IS31BL3229

PIN CONFIGURATION

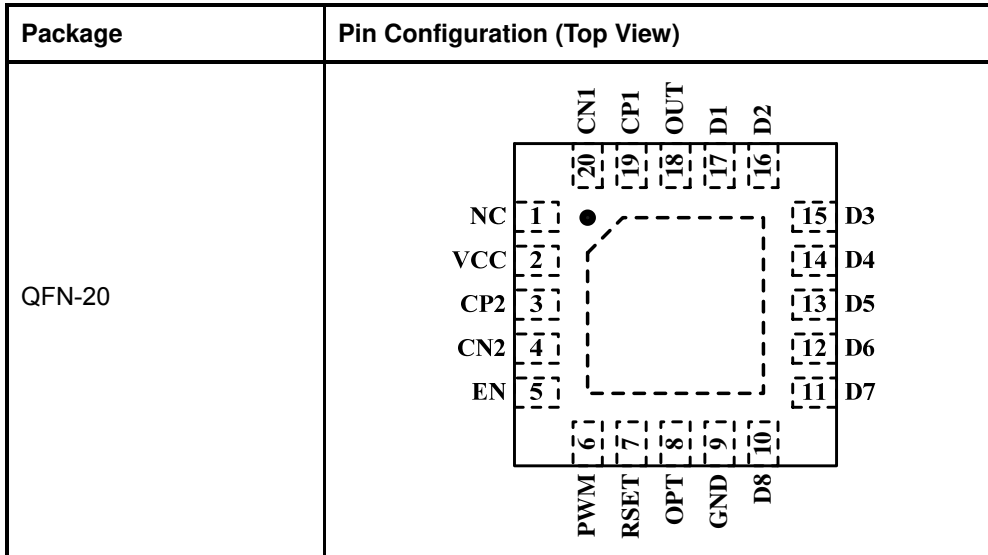

PIN DESCRIPTION

No.	Pin	Description
1	NC	No connection.
2	VCC	Power supply input, requires 0.1μF and 1μF capacitor connect between this pin and ground pin.
3	CP2	Flying capacitor positive terminal 2.
4	CN2	Flying capacitor negative terminal 2.
5	EN	Shutdown and output current control pin. Pull low to shutdown the IC.
6	PWM	PWM control pin. Adjust the LED intensity by PWM duty cycle. Pull low at least 128ms (Typ.), the IC should be shutdown.
7	RSET	External resistor for bias current. $I_{MAX} = (1.25 / R_{SET}) \times 1600$
8	OPT	Option pin. Floating to operating in FIFO mode. Pull low to disable FIFO.
9	GND	Ground.
10~17	D8~D1	White LED channel 8~1. D1 must be connected and others can be floating in less than 8 LEDs application.
18	OUT	Charge pump output to drive load circuits, Requires 1μF capacitor connected between this pin and ground pin.
19	CP1	Flying capacitor positive terminal 1.
20	CN1	Flying capacitor negative terminal 1.
	Thermal Pad	Connect to GND.



IS31BL3229

ORDERING INFORMATION

Industrial Range: -40°C to +85°C

Order Part No.	Package	QTY/Reel
IS31BL3229-QFLS2-TR	QFN-20, Lead-free	2500

Copyright © 2012 Integrated Silicon Solution, Inc. All rights reserved. ISSI reserves the right to make changes to this specification and its products at any time without notice. ISSI assumes no liability arising out of the application or use of any information, products or services described herein. Customers are advised to obtain the latest version of this device specification before relying on any published information and before placing orders for products. Integrated Silicon Solution, Inc. does not recommend the use of any of its products in life support applications where the failure or malfunction of the product can reasonably be expected to cause failure of the life support system or to significantly affect its safety or effectiveness. Products are not authorized for use in such applications unless Integrated Silicon Solution, Inc. receives written assurance to its satisfaction, that:

- a.) the risk of injury or damage has been minimized;
- b.) the user assume all such risks; and
- c.) potential liability of Integrated Silicon Solution, Inc is adequately protected under the circumstances



IS31BL3229

ABSOLUTE MAXIMUM RATINGS

Supply voltage, V_{CC}	-0.3V ~ +6.0V
Voltage at any input pin	-0.3V ~ $V_{CC}+0.3V$
Junction temperature, T_{JMAX}	150°C
Storage temperature range, T_{STG}	-65°C ~ +150°C
Operating temperature ratings, T_A	-40°C ~ +85°C

Note:

Stresses beyond those listed under "Absolute Maximum Ratings" may cause permanent damage to the device. These are stress ratings only and functional operation of the device at these or any other condition beyond those indicated in the operational sections of the specifications is not implied. Exposure to absolute maximum rating conditions for extended periods may affect device reliability.

ELECTRICAL CHARACTERISTICS

$V_{CC} = 2.7V \sim 5.5V$, $T_A = 25^\circ C$, unless otherwise noted. Typical value are $T_A = 25^\circ C$, $V_{CC} = 3.6V$.

Symbol	Parameter	Condition	Min.	Typ.	Max.	Unit
V_{CC}	Operation range		2.7		5.5	V
I_{CC}	Operating current	1x mode, no load		0.7		mA
		1.5x mode, no load		2		
I_{SD}	Shutdown current	$V_{EN} = 0V$		1		μA
I_{OUT}	Output current				200	mA
I_{LED}	LED current for each channel	$R_{SET} = 100k\Omega$		20		mA
$I_{(D-Match)}$	Current matching between any two outputs			1		%
V_{TH}	Transition threshold (D1 pin)	V_{D1} falling		180		mV
V_{UVLO}	Input under voltage lockout threshold	V_{CC} rising or falling. 100mV hysteresis		2.4		V
V_{SET}	Bias voltage for RSET pin			1.25		V
V_{OVP}	Over voltage protect			5.5		V
t_{FI}	Fade in time	FIFO Mode (Note 5)		400		ms
t_{FO}	Fade out time	FIFO Mode (Note 5)		400		ms
R_{DS_ON}	Output resistor	1x mode: $(V_{CC}-V_{OUT})/I_{OUT}$			1	Ω
T_{OTP}	Over temperature protection	(Note 6)		160		$^\circ C$
T_{HYS}	Over temperature protection hysteresis	(Note 6)		40		$^\circ C$

Charge Pump Characteristics

t_{ST}	Soft-start time	(Note 6)		150		μs
f_{CLK}	Clock frequency	(Note 6)		1		MHz



IS31BL3229

ELECTRICAL CHARACTERISTICS (Continue)

$V_{CC} = 2.7V \sim 5.5V$, $T_A = 25^\circ C$, unless otherwise noted. Typical value are $T_A = 25^\circ C$, $V_{CC} = 3.6V$.

Symbol	Parameter	Condition	Min.	Typ.	Max.	Unit
EN, PWM Pin Characteristics						
V_{IL}	Enable threshold low	$V_{CC} = 2.7V$			0.4	V
V_{IH}	Enable threshold high	$V_{CC} = 5.5V$	1.4			V
t_{LO}	EN low time	(Note 6)	0.5		75	μs
t_{HI}	EN high time	(Note 6)	0.5		75	μs
t_{OFF}	EN off time	(Note 6)	500			μs
t_{LAT}	EN latch time	(Note 6)	500			μs
f_{PWM}	Input frequency for PWM pin		0.1		50	kHz
t_{OFF_PWM}	PWM off time	(Note 7)		128		ms

Note 5: Typical value.

Note 6: Guaranteed by design.

Note 7: As the PWM pin is pulled low at least 128ms, the IS31BL3229 will be shutdown.

TYPICAL PERFORMANCE CHARACTERISTIC

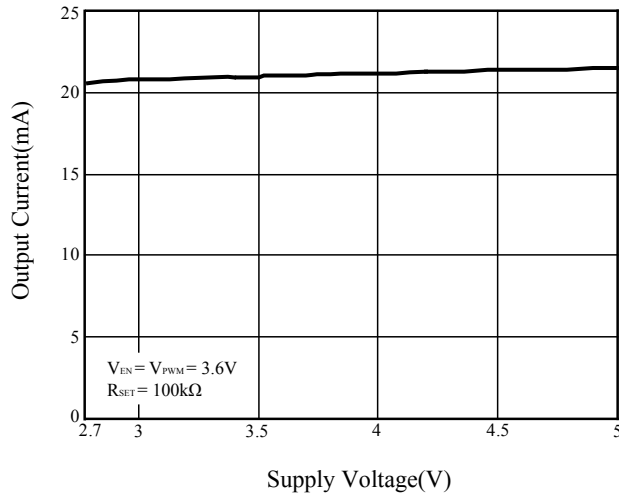

Figure 2 Supply Voltage vs. Output Current

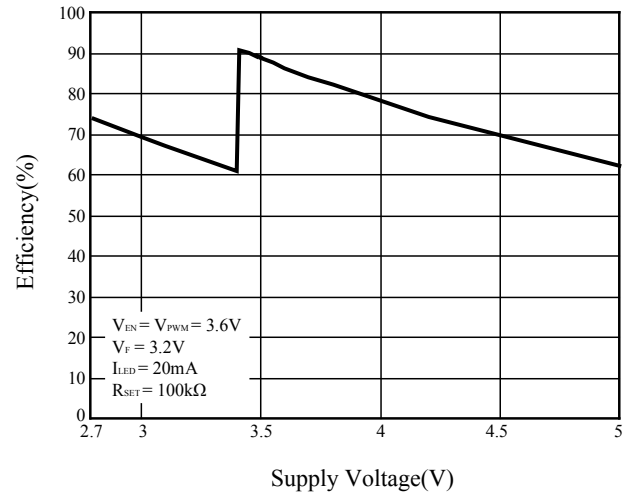

Figure 3 Supply Voltage vs. Efficiency

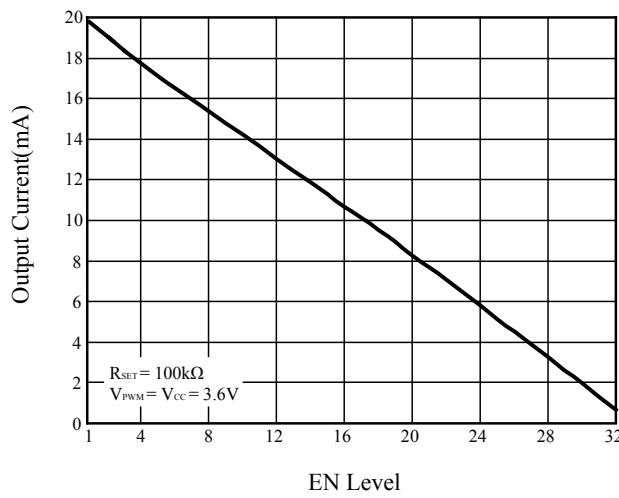

Figure 4 EN pin dimming

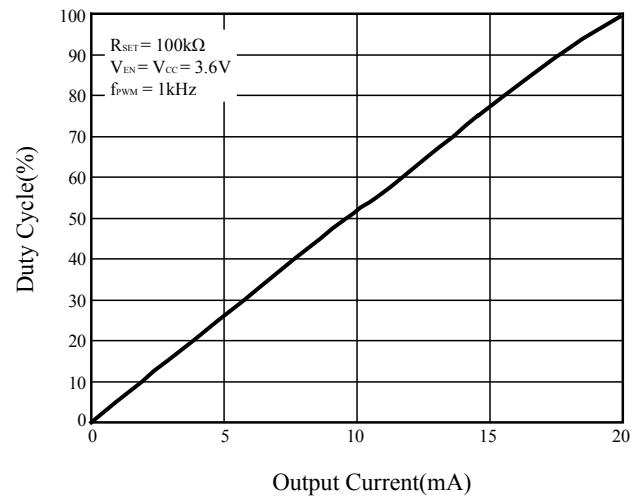
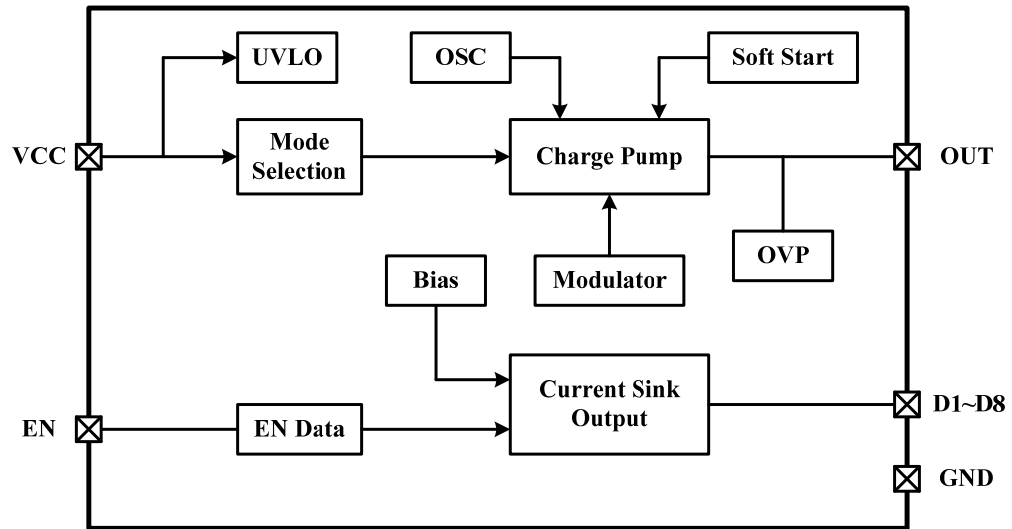

Figure 5 PWM pin dimming

IS31BL3229

FUNCTION BLOCK



IS31BL3229

APPLICATION INFORMATION

GENERAL DESCRIPTION

The IS31BL3229 with a smart charge-pump circuit is a parallel white-LED driver with eight matched 20mA current outputs.

CHARGE PUMP

The built-in charge pump converter switches on automatically to ensure constant current output when the voltage of channel 1 (V_{D1}) is below the threshold voltage V_{TH} (180mV).

The charge pump converter only needs three external components: supply decoupling capacitor, output bypass capacitor and flying capacitor.

Choose low ESR capacitors to ensure the best operating performance and place the capacitors as close as possible to the IS31BL3229.

OUTPUT CURRENT SETTING

The maximum current (I_{MAX}) of each LED can be set by the extra resistor R_{SET} follow the Equation (1) below.

$$I_{MAX} = (1.25 / R_{SET}) \times 1600 \quad (1)$$

For example, in Figure 1, $R_{SET} = 100k\Omega$,

$$\text{So, } I_{MAX} = (1.25 / 100k\Omega) \times 1600 = 20mA$$

The recommended minimum R_{SET} is 82k Ω , then the maximum I_{MAX} is 24mA.

The recommended maximum R_{SET} is 110k Ω , then the minimum I_{MAX} is 18mA.

FUNCTIONAL DESCRIPTION

The LED intensity can be modulated by pulse count or PWM signal.

EN DIMMING MODE

The current level magnitude is controlled by Pulse Count Control (PCC wire) serial interface. The interface records rising edges of the EN pin and decodes them into 32 different states. The 32 current level settings available are indicated in Table 1. The PWM pin should be pulled to high if modulated by EN pin only.

PWM SIGNAL DIMMING MODE

The PWM pin of the IS31BL3229 can accept a PWM signal to implement LED dimming by changing the PWM duty cycle. Recommended PWM frequency is in the range of 100Hz ~ 50kHz.

Table 1 Current Level Setting (Typical)

$V_{CC} = 3.6V$, $R_{SET} = 100k\Omega$, PWM pin is high.

Pulse	I_{LED} (mA/Ch)	Pulse	I_{LED} (mA/Ch)	Pulse	I_{LED} (mA/Ch)
1	20.0	12	13.125	23	6.25
2	19.375	13	12.5	24	5.625
3	18.75	14	11.875	25	5
4	18.125	15	11.25	26	4.375
5	17.5	16	10.625	27	3.75
6	16.875	17	10	28	3.125
7	16.25	18	9.375	29	2.5
8	15.625	19	8.75	30	1.875
9	15	20	8.125	31	1.25
10	14.375	21	7.5	≥32	0.625
11	13.75	22	6.875		

FADE IN AND FADE OUT MODE

By floating the OPT pin the fade in and fade out mode enable. When the EN pin is pulled high to enable the IC, LED fade in. When the EN pin is pulled low at last t_{OFF} to shutdown the IC, LED fade out. Pulling OPT pin low to disable this mode (Figure 6).

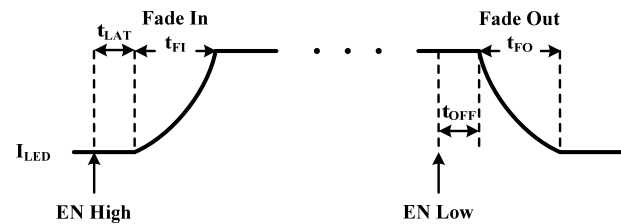

Figure 6 FIFO Function

TIMING CONTROL

The EN pin should be configured as the Figure 7. t_{LAT} is the latch time. High level should be at least t_{LAT} to active the pulse signal. t_{OFF} is the shutdown time. EN pin is pulled low at last t_{OFF} the IC will be shutdown.

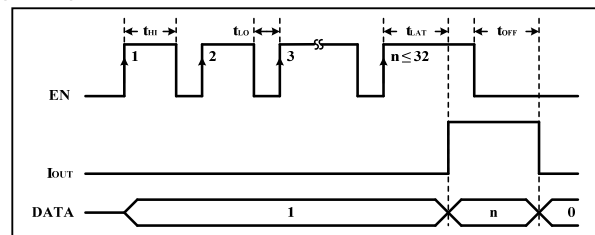

Figure 7 EN pin timing



IS31BL3229

THERMAL PROTECTION

The IS31BL3229 has a thermal protection circuit that will shut down the chip if the die temperature rises above the thermal limit until the temperature falls down.

DESIGN NOTE

The decoupling capacitors should be placed close to the VCC pin. A 0.1 μ F ceramic and an 1 μ F capacitors are recommended. The flying capacitor should be placed close to the CN and CP pins. The output capacitor should be placed close to the OUT pin and the traces of OUT pin connected to the capacitor should be as possible as short and wide.

Trace width should be at least 0.75mm when the current reaches 1A. Trace width should be at least 1.0mm for the power supply and the ground plane. The thermal pad and the GND pin should connect directly to a strong common ground plane for heat sinking.

IS31BL3229

CLASSIFICATION REFLOW PROFILES

Profile Feature	Pb-Free Assembly
Preheat & Soak	
Temperature min (T _{smin})	150°C
Temperature max (T _{smax})	200°C
Time (T _{smin} to T _{smax}) (t _s)	60-120 seconds
Average ramp-up rate (T _{smax} to T _p)	3°C/second max.
Liquidous temperature (T _L)	217°C
Time at liquidous (t _L)	60-150 seconds
Peak package body temperature (T _p)*	Max 260°C
Time (t _p)** within 5°C of the specified classification temperature (T _c)	Max 30 seconds
Average ramp-down rate (T _p to T _{smax})	6°C/second max.
Time 25°C to peak temperature	8 minutes max.

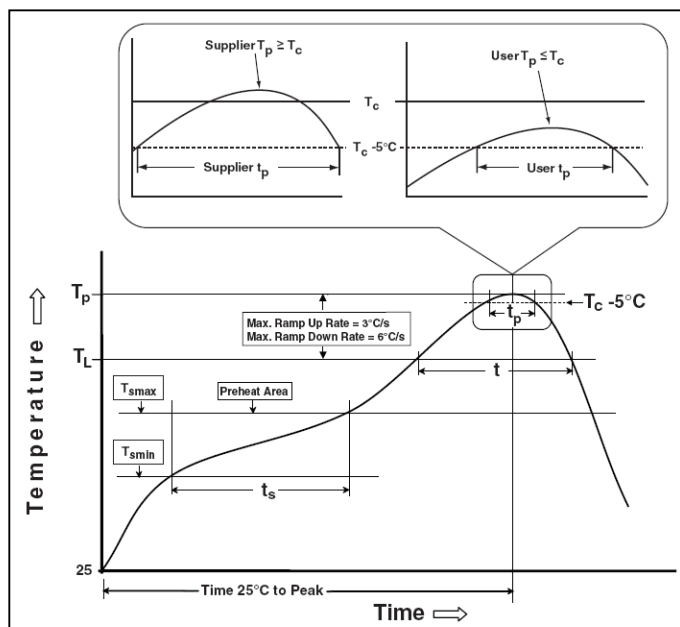
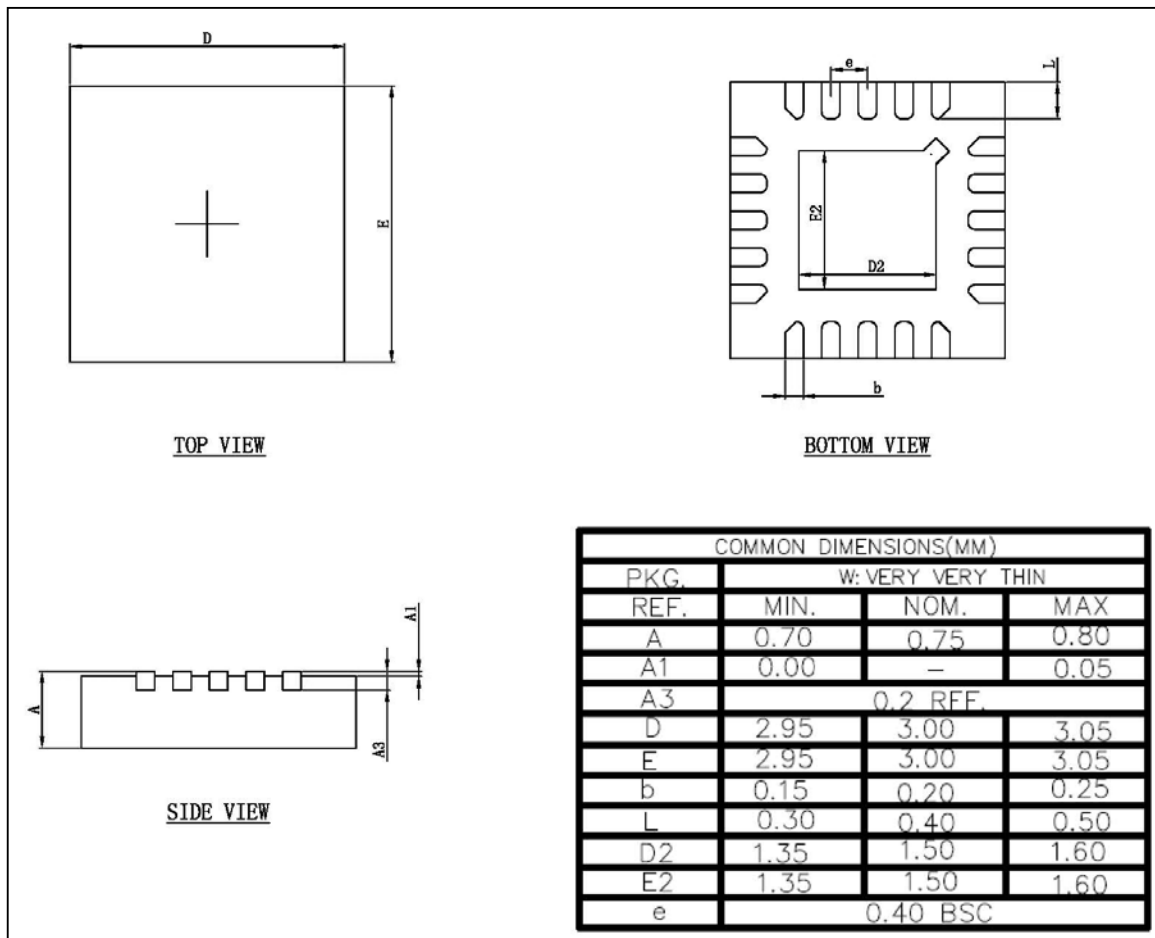

Figure 8 Classification profile

IS31BL3229

PACKAGE INFORMATION

QFN-20



Note: All dimensions in millimeters unless otherwise stated.