



Chipsmall Limited consists of a professional team with an average of over 10 year of expertise in the distribution of electronic components. Based in Hongkong, we have already established firm and mutual-benefit business relationships with customers from,Europe,America and south Asia,supplying obsolete and hard-to-find components to meet their specific needs.

With the principle of "Quality Parts,Customers Priority,Honest Operation,and Considerate Service",our business mainly focus on the distribution of electronic components. Line cards we deal with include Microchip,ALPS,ROHM,Xilinx,Pulse,ON,Everlight and Freescale. Main products comprise IC,Modules,Potentiometer,IC Socket,Relay,Connector.Our parts cover such applications as commercial,industrial, and automotives areas.

We are looking forward to setting up business relationship with you and hope to provide you with the best service and solution. Let us make a better world for our industry!



## Contact us

Tel: +86-755-8981 8866 Fax: +86-755-8427 6832

Email & Skype: info@chipsmall.com Web: www.chipsmall.com

Address: A1208, Overseas Decoration Building, #122 Zhenhua RD., Futian, Shenzhen, China



### GENERAL DESCRIPTION

The IS31LT3354 is a continuous mode inductive step-down converter, designed for driving a single LED or multiple series connected LEDs efficiently from a voltage source higher than the required LED voltage.

The device operates from an input supply between 6V and 40V and provides an externally adjustable output current of up to 2A or even higher, which is determined by the external MOSFET and inductor.

The IS31LT3354 includes a high-side output current sensing circuit, which uses an external resistor to set the nominal average output current.

Output current can be adjusted linearly by applying an external control signal to the ADJ pin. The ADJ pin will accept either a DC voltage or a PWM waveform. This will provide either a continuous or a gated output current.

Applying a voltage of 0.2V or lower to the ADJ pin turns the output off and switches the chip into a low current standby state.

The chip is assembled in SOT23-5 package.

### FEATURES

- Simple low parts count
- Wide input voltage range: 6V to 40V
- Output Current only limited by external component selection
- High efficiency (up to 98% )
- Typical 1200:1 dimming ratio
- Typical 3% output current accuracy
- Single pin on/off and brightness control using DC voltage or PWM
- Up to 1MHz switching frequency
- Inherent open-circuit LED protection
- Thermal shutdown protection circuitry

### APPLICATIONS

- Low voltage halogen replacement LEDs
- Automotive lighting
- Low voltage industrial lighting
- LED back-up lighting
- Illuminated sign

### TYPICAL APPLICATION CIRCUIT

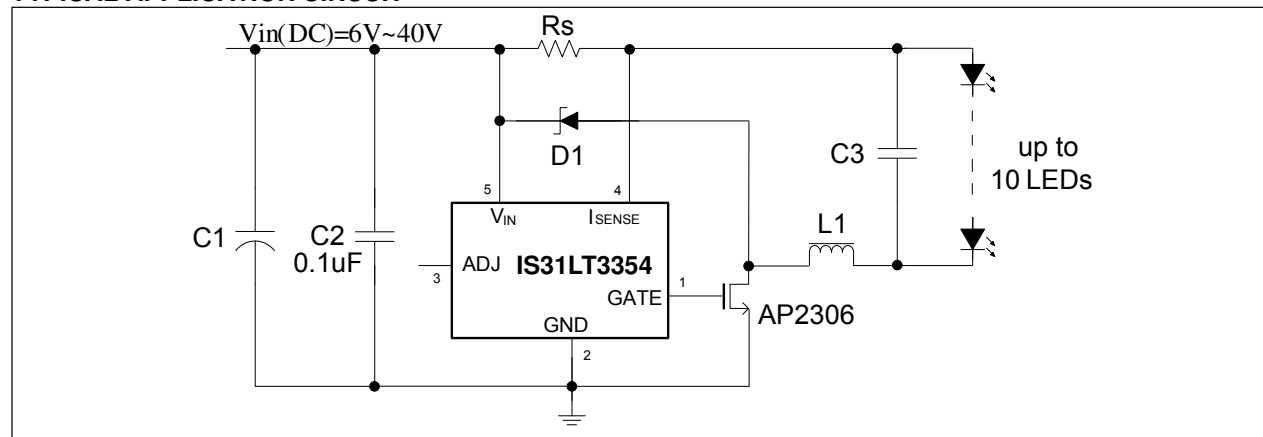

Figure 1 Typical IS31LT3354 Application Schematic

Copyright © 2011 Integrated Silicon Solution, Inc. All rights reserved. ISSI reserves the right to make changes to this specification and its products at any time without notice. ISSI assumes no liability arising out of the application or use of any information, products or services described herein. Customers are advised to obtain the latest version of this device specification before relying on any published information and before placing orders for products.

Integrated Silicon Solution, Inc. does not recommend the use of any of its products in life support applications where the failure or malfunction of the product can reasonably be expected to cause failure of the life support system or to significantly affect its safety or effectiveness. Products are not authorized for use in such applications unless Integrated Silicon Solution, Inc. receives written assurance to its satisfaction, that:

- a.) the risk of injury or damage has been minimized;
- b.) the user assume all such risks; and
- c.) potential liability of Integrated Silicon Solution, Inc is adequately protected under the circumstances

## PIN CONFIGURATION

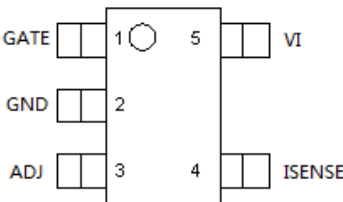
Package	Pin Configuration (Top view)
SOT23-5	

## PIN DESCRIPTION

Pin Name	NO.	Description
GATE	1	Output gate driver for an external NMOSFET
GND	2	Ground (0V)
ADJ	3	Multi-function On/Off and brightness control pin: * Leave floating for normal operation. ( $V_{ADJ} = V_{REF} = 1.2V$ giving nominal average output current $I_{OUTnom} = 0.1/R_S$ ) * Drive to voltage below 0.2V to turn off output current * Drive with DC voltage ( $0.3V < V_{ADJ} < 1.2V$ ) to adjust output current from 25% to 100% of $I_{OUTnom}$ * Drive with PWM signal to adjust output current. * When driving the ADJ pin above 1.2V, the current will be clamped to 100% brightness automatically.
$I_{SENSE}$	4	Connect resistor $R_S$ from this pin to $V_{IN}$ to define nominal average output current $I_{OUTnom} = 0.1/R_S$
$V_{IN}$	5	Input voltage (6V to 40V). Decouple to ground with 1 $\mu$ F or higher X7R ceramic capacitor close to device

## ORDERING INFORMATION

### INDUSTRIAL RANGE: -40°C TO +85°C

Order Part No.	Package	QTY/Reel
IS31LT3354-STLS2-TR	SOT23-5, Lead-free	3000

## ABSOLUTE MAXIMUM RATINGS (NOTE 1)

Symbol	Parameter	Rating
$V_{IN}$	Input voltage	-0.3V to +50V
$V_{ISENSE}$	$I_{SENSE}$ voltage	$V_{IN}+0.3V$ to $V_{IN}-5V$ , $V_{IN}>5V$
		$V_{IN}+0.3V$ to $-0.3V$ , $V_{IN}<5V$
$V_{GATE}$	GATE pin voltage	-0.3V to +6V
$V_{ADJ}$	Adjust pin input voltage	-0.3V to +6V
$P_{tot}$	Power dissipation	600mW @SOT23-5
$T_{OP}$	Operating temperature	-40 to 85°C
$T_{ST}$	Storage temperature	-55 to 150°C
$T_{JMAX}$	Junction temperature	150°C
$R_{\theta JA}$	Junction to ambient	108°C/W @SOT23-5
	ESD Susceptibility (human body model)	4kV

## ELECTRICAL CHARACTERISTICS

 $T_A = 25^\circ\text{C}$  (Note 2)

Symbol	Parameter	Conditions	Min.	Typ.	Max.	Unit
$V_{IN}$	Input voltage		6		40	V
$I_{INQoff}$	Quiescent supply current with output off	ADJ pin grounded	80	95	110	$\mu\text{A}$
$I_{INQon}$	Quiescent supply current with output switching	ADJ pin floating		450	600	$\mu\text{A}$
$V_{SENSE}$	Mean current sense threshold voltage		91	96	101	mV
$V_{SENSEHYS}$	Sense threshold hysteresis			$\pm 15$		%
$I_{SENSE}$	$I_{SENSE}$ pin input current	$V_{SENSE} = 0.1V$		8	10	$\mu\text{A}$
$V_{REF}$	Internal reference voltage	Measured on ADJ pin with pin floating		1.2		V
$V_{ADJ}$	External control voltage range on ADJ pin for dc brightness control		0.3		1.2	V
$V_{ADJoff}$	DC voltage on ADJ pin to switch chip from active (on) state to quiescent (off) state	$V_{ADJ}$ falling	0.15	0.2	0.25	V
$V_{ADJon}$	DC voltage on ADJ pin to switch chip from quiescent (off) state to active (on) state	$V_{ADJ}$ rising	0.2	0.25	0.3	V
$R_{ADJ}$	Resistance between ADJ pin and $V_{REF}$			500		$\text{K}\Omega$

# IS31LT3354

## ELECTRICAL CHARACTERISTICS

$T_A = 25^\circ\text{C}$ ,  $V_{IN} = 12\text{V}$  (Note 3)

Symbol	Parameter	Conditions	Min.	Typ.	Max.	Unit
$I_{\text{source}}$	Gate sourcing current			80		mA
$I_{\text{sink}}$	Gate sinking current			100		mA
$D_{\text{PWM(LF)}}$	Brightness control range at low frequency PWM signal	PWM frequency =100Hz PWM amplitude=5V, $V_{in}=15\text{V}$ , $L=27\mu\text{H}$ , Driving 1 LED		1200:1		
$D_{\text{PWM(HF)}}$	Brightness control range at low frequency PWM signal	PWM frequency =10KHz PWM amplitude=5V, $V_{in}=15\text{V}$ , $L=27\mu\text{H}$ , Driving 1 LED		13:1		
$f_{\text{SW}}$	Operating frequency	ADJ pin floating $L=100\mu\text{H}$ ( $0.82\Omega$ ) $I_{\text{OUT}}=350\text{mA}$ @ $V_{\text{LED}}=3.4\text{V}$ Driving 1 LED		154		KHz
$T_{\text{ONmin}}$	Minimum switch 'ON' time			200		ns
$T_{\text{OFFmin}}$	Minimum switch 'OFF' time			200		ns
$f_{\text{SWmax}}$	Recommended maximum operating frequency				1	MHz
$D_{\text{SW}}$	Recommended duty cycle range of output switch at $f_{\text{SWmax}}$		0.3	0.7	0.9	
$T_{\text{PD}}$	Internal comparator propagation delay			50		ns
$T_{\text{SD}}$	Thermal shutdown temperature			140		$^\circ\text{C}$
$T_{\text{SD-HYS}}$	Thermal shutdown hysteresis			20		$^\circ\text{C}$

### Notes:

1. Stresses beyond those listed under absolute maximum ratings may cause permanent damage to the device. These are stress ratings only, and functional operation of the device at these or any other conditions beyond those indicated under recommended operating conditions is not implied. Exposure to absolute-maximum-rated conditions for extended periods may affect device reliability.
2. All parts are production tested at  $T_A = 25^\circ\text{C}$ . Other temperature limits are guaranteed by design
3. Guaranteed by design

## TYPICAL PERFORMANCE CHARACTERISTICS

For typical application circuit and  $T_{amb}=25^{\circ}\text{C}$  unless otherwise stated.

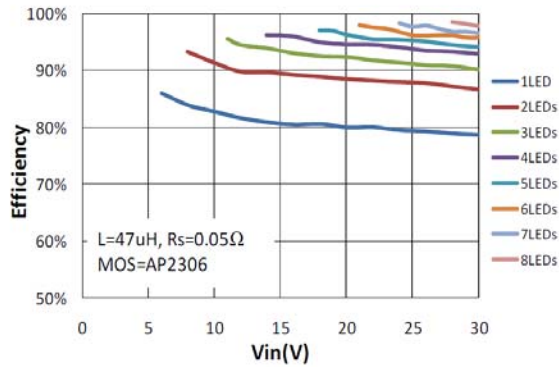

Efficiency vs. No. of LEDs

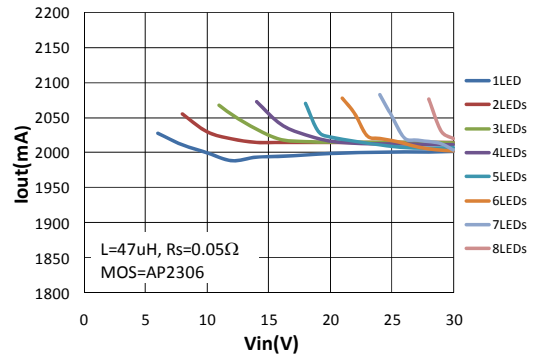

Output current variation with Supply Voltage

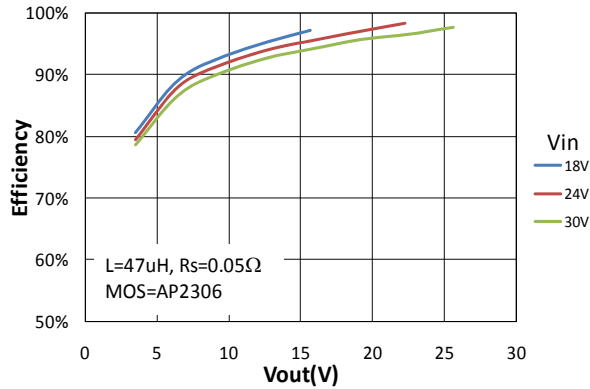

Efficiency vs. Output Voltage

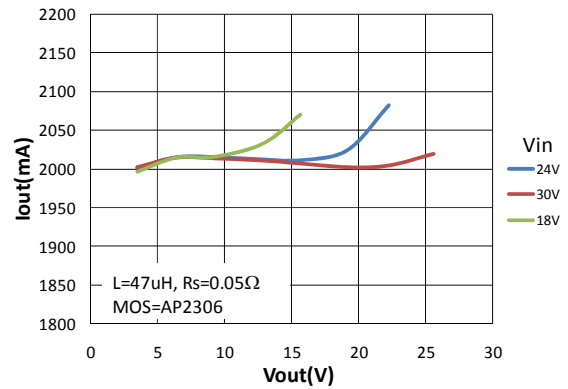

Output current variation with Output Voltage

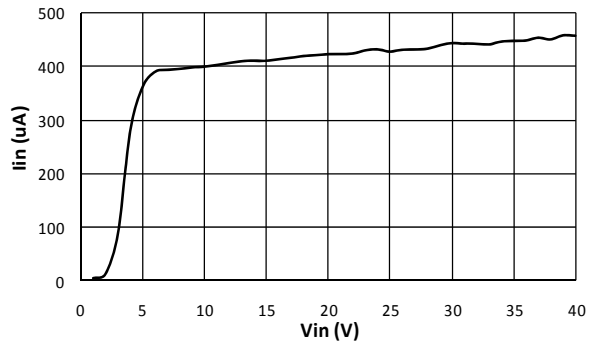

Supply Current vs. Vin (Operating)

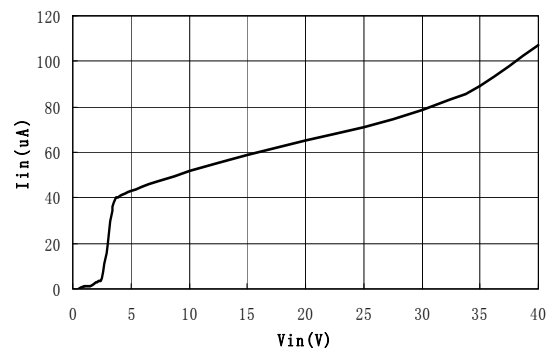

Shutdown Current vs. Vin (Quiescent)

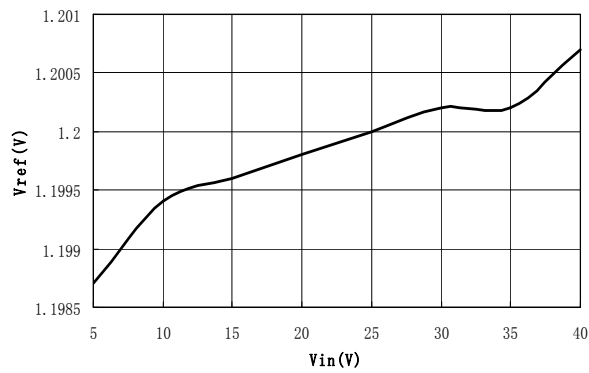

Vref vs. Vin

## APPLICATION INFORMATION

### Setting nominal average output current with external resistor $R_S$

The nominal average output current in the LED(s) is determined by the value of the external current sense resistor ( $R_S$ ) connected between  $V_{IN}$  and  $I_{SENSE}$  and is given by:

$$I_{OUT\ nom} = 0.1/R_S$$

The table below gives values of nominal average output current for several preferred values of current setting resistor ( $R_S$ ) in the typical application circuit shown on page 1:

$R_S$ ( $\Omega$ )	Nominal average output current (mA)
0.05	2000
0.083	1200
0.15	667
0.3	333

$V_{sense}$  is divided into two ranges to improve current accuracy, please refer to bin information on page 3. The above values assume that the ADJ pin is floating and at a nominal voltage of  $V_{REF} = 1.2V$ . It is possible to use different values of  $R_S$  if the ADJ pin is driven from an external voltage.  $R_S$  need to be chosen 1% accuracy resistor with enough power tolerance and good temperature characteristic to ensure stable output current.

### Output current adjustment by external DC control voltage

The ADJ pin can be driven by an external dc voltage ( $V_{ADJ}$ ), as shown, to adjust the output current to a value above or below the nominal average value defined by  $R_S$ .

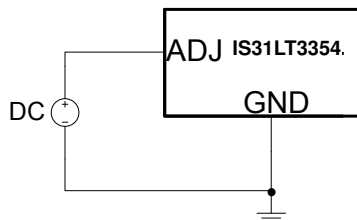

The nominal average output current in this case is given by:  
 $I_{OUTdc} = 0.083 \cdot V_{ADJ} / R_S$  [for  $0.3V < V_{ADJ} < 1.2V$ ]  
 Note that 100% brightness setting corresponds to  $V_{ADJ} = V_{REF}$ . When driving the ADJ pin above 1.2V, the current will be clamped to 100% brightness automatically.  
 The input impedance of the ADJ pin is  $500k\Omega \pm 25\%$ .

### Output current adjustment by PWM control

#### Directly driving ADJ input

A Pulse Width Modulated (PWM) signal with duty cycle  $D_{PWM}$  can be applied to the ADJ pin, as shown below, to adjust the output current to a value below the nominal average value set by resistor  $R_S$ , the signal range is from 0V~5V. The PWM signal must have the driving ability to drive internal 500K $\Omega$  pull-up resistor.

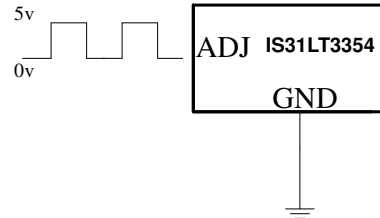

#### Driving the ADJ input from a microcontroller

Another possibility is to drive the chip from the open drain output of a microcontroller. The diagram below shows one method of doing this:

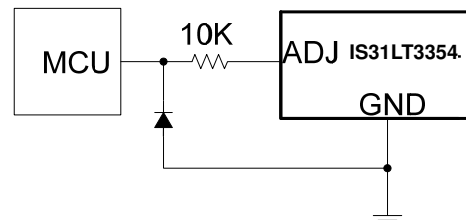

The diode and resistor suppress possible high amplitude negative spikes on the ADJ input resulting from the drain-source capacitance of the FET. Negative spikes at the input to the chip should be avoided as they may cause errors in output current or erratic device operation. See the section on PWM dimming for more details of the various modes of control using high frequency and low frequency PWM signals.

#### Shutdown mode

Taking the ADJ pin to a voltage below 0.2V will turn off the output and supply current will fall to a low standby level of 95 $\mu A$  nominal.



## Inherent open-circuit LED protection

If the connection to the LED(s) is open-circuited, the coil is isolated from the switch, so neither the chip nor the switch will be damaged, unlike in many boost converters, where the back EMF may damage the switch by forcing the drain above its breakdown voltage.

## Capacitor selection

A low ESR capacitor should be used for input decoupling, as the ESR of this capacitor appears in series with the supply source impedance and lowers overall efficiency. This capacitor has to supply the relatively high peak current to the coil and smooth the current ripple on the input supply.

If the source is DC supply, the capacitor is decided by ripple of the source, the value is given by:

$$C_{\min} = \frac{I_F * T_{on}}{\Delta U_{MAX}}$$

$I_F$  is the value of output current,  $\Delta U_{MAX}$  is the ripple of power supply.  $T_{on}$  is the "ON" time of MOSFET the value is normally 2 times of the minimum value.

If the source is an AC supply, typical output voltages ripple from a nominal 12V AC transformer can be  $\pm 10\%$ . If the input capacitor value is lower than 200 $\mu$ F, the AC input waveform is distorted, sometimes the lowest value will be lower than the forward voltage of LED strings. This lowers the average current of the LEDs. So it is recommended to set the value of the capacitor bigger than 200 $\mu$ F.

For maximum stability over temperature and voltage, capacitors with X7R, X5R, or better dielectric are recommended. Capacitors with Y5V dielectric are not suitable for decoupling in this application and should not be used.

## Switch MOSFET selection

The IS31LT3354 demands a power N-MOSFET as a switch. The voltage and current rating of the MOSFET must be higher than the application output voltage and the inductor peak current. The  $V_{GS(th)}$  of MOSFET should be lower than 3V and the  $R_{DS(on)}$  should be as low as possible for maximum efficiency and performance. AP2306 and AP2310 are recommended. NOTE: For the recommended MOSFETs, the maximum load current is about 2A. For high current applications, the operating input voltage, the LED current, and the switching frequency will determine the operating temperature of the MOSFET. Switching frequency can be lowered by choosing a larger value of inductance, however, the MOSFET specifications must be carefully analyzed first. The key specifications to consider are  $R_{DS(on)}$  and  $C_{DS}$ , both should be as low as possible.

## Inductor selection

Recommended inductor values for the IS31LT3354 are in the range 47 $\mu$ H to 220 $\mu$ H.

Higher values of inductance are recommended at higher supply voltages and low output current in order to minimize errors due to switching delays, which result in increased ripple and lower efficiency. Higher values of inductance also result in a smaller change in output current over the supply voltage range. (See graphs). The inductor should be mounted as close to the chip as possible with low resistance connections to the GATE and  $V_{IN}$  pins.

The chosen coil should have a saturation current higher than the peak output current and a continuous current rating above the required mean output current. It is recommended to use an inductor with saturation current bigger than 1.2A for 700mA output current and inductor with saturation current bigger than 500mA for 350mA output current.

The inductor value should be chosen to maintain operating duty cycle and switch 'on/off' times within the specified limits over the supply voltage and load current range.

The following equations can be used as a guide.

## Switch 'On' time

$$T_{ON} = \frac{L\Delta I}{V_{IN} - V_{LED} - I_{AVG}(R_S + r_L + R_{LX})}$$

Note:  $T_{ONmin} > 200ns$

## Switch 'Off' time

$$T_{OFF} = \frac{L\Delta I}{V_{LED} + V_D + I_{AVG}(r_L + R_S)}$$

Note:  $T_{OFFmin} > 200ns$

Where:

L is the coil inductance (H)

$r_L$  is the coil resistance ( $\Omega$ )

$I_{avg}$  is the required LED current (A)

$\Delta I$  is the coil peak-peak ripple current (A) {Internally set to  $0.3 \times I_{avg}$ }

$V_{IN}$  is the supply voltage (V)

$V_{LED}$  is the total LED forward voltage (V)

$R_{LX}$  is the switch resistance ( $\Omega$ )

$V_D$  is the diode forward voltage at the required load current (V)

# IS31LT3354

## Example:

For  $V_{IN}=12V$ ,  $L=47\mu H$ ,  $r_L=0.64\Omega$ ,  $V_{LED}=3.4V$ ,  $I_{avg}=333mA$  and  $V_D=0.36V$

$$T_{ON} = (47e-6 \times 0.105)/(12 - 3.4 - 0.612) = 0.62\mu s$$

$$T_{OFF} = (47e-6 \times 0.105)/(3.4 + 0.36 + 0.322) = 1.21\mu s$$

This gives an operating frequency of 546kHz and a duty cycle of 0.34

Optimum performance will be achieved by setting the duty cycle close to 0.5 at the nominal supply voltage. This helps to equalize the undershoot and overshoot and improves temperature stability of the output current.

## Diode selection

For maximum efficiency and performance, the rectifier (D1) should be a fast low capacitance Schottky diode with low reverse leakage at the maximum operating voltage and temperature.

If alternative diodes are used, it is important to select parts with a peak current rating above the peak coil current and a continuous current rating higher than the maximum output load current. It is very important to consider the reverse leakage of the diode when operating above 85°C. Excess leakage will increase the power dissipation in the device.

The higher forward voltage and overshoot due to reverse recovery time in silicon diodes will increase the peak voltage on the switch. If a silicon diode is used, care should be taken to ensure that the total voltage appearing across the switch including supply ripple, does not exceed the specified maximum value.

## Reducing output ripple

Peak to peak ripple current in the LED can be reduced, if required, by shunting a capacitor  $C_{led}$  across the LED(s) as shown below:

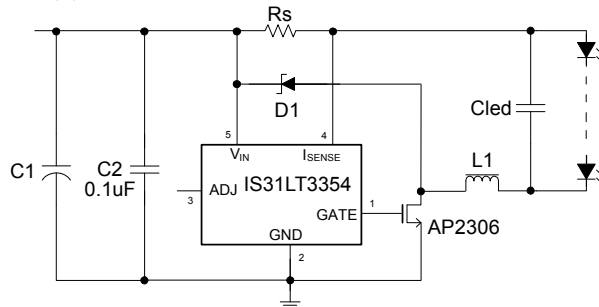

A value of 1 $\mu F$  will reduce nominal ripple current by a factor three (approx.). Proportionally, lower ripple can be achieved with higher capacitor values. Note that the capacitor will not affect operating frequency or efficiency, but it will increase start-up delay by reducing the rate of rise of LED voltage.

## Operation at low supply voltage

The internal regulator disables the driving to the switch until the supply has risen above the startup threshold set internally which makes the power MOSFET's on-resistance small enough. Above this threshold, the chip will start to operate. However, with the supply voltage below the specified minimum value, the switch duty cycle will be high and the chip power dissipation will be at a maximum. Care should be taken to avoid operating the chip under such conditions in the application, in order to minimize the risk of exceeding the maximum allowed die temperature. (See next section on thermal considerations).

Note that when driving loads of two or more LEDs, the forward drop will normally be sufficient to prevent the chip from switching below approximately 6V. This will minimize the risk of damage to the chip.

## Thermal considerations

The IS31LT3354 utilizes an external MOSFET to switch the inductor current, and thus dissipates very little power. The thermal characteristics of the MOSFET dominate in typical application circuits for the IS31LT3354. Care should be taken to ensure a large copper ground plane and a good thermal conductivity between the MOSFET and the ground plane.

Note that the switch power dissipation increases with increasing supply voltage. This is caused primarily by two things, the resulting increase in switching frequency and the higher voltage across the switch during the off time. This may result from the use of unsuitable coils, or excessive parasitic output capacitance on the switch output.

## Layout considerations

### External MOSFET Drain

The Drain of the external MOSFET is a fast switching node, so PCB traces should be kept as short as possible. To minimize ground 'bounce', the ground pin of the chip should be soldered directly to the ground plane.

### Coil and decoupling capacitors

It is particularly important to mount the coil and the input decoupling capacitor close to the chip to minimize parasitic resistance and inductance, which will degrade efficiency. It is also important to take account of any trace resistance in series with current sense resistor  $R_S$ .

### ADJ pin

The ADJ pin is a high impedance input, so when left floating, PCB traces to this pin should be as short as possible to reduce noise pickup. ADJ pin can also be connected to a voltage between 1.2V~5V. In this case, the internal circuit will clamp the output current at the value which is set by  $ADJ=1.2V$ .

### High voltage traces

Avoid running any high voltage traces close to the ADJ pin, to reduce the risk of leakage due to board contamination. Any such leakage may raise the ADJ pin voltage and cause excessive output current. A ground ring placed around the ADJ pin will minimize changes in output current under these conditions.

## CLASSIFICATION REFLOW PROFILES

Profile Feature	Pb-Free Assembly
Preheat & Soak Temperature min (T <sub>smin</sub> ) Temperature max (T <sub>smax</sub> ) Time (T <sub>smin</sub> to T <sub>smax</sub> ) (t <sub>s</sub> )	150°C 200°C 60-120 seconds
Average ramp-up rate (T <sub>smax</sub> to T <sub>p</sub> )	3°C/second max.
Liquidous temperature (T <sub>L</sub> ) Time at liquidous (t <sub>L</sub> )	217°C 60-150 seconds
Peak package body temperature (T <sub>p</sub> )*	Max 260°C
Time (t <sub>p</sub> )** within 5°C of the specified classification temperature (T <sub>c</sub> )	Max 30 seconds
Average ramp-down rate (T <sub>p</sub> to T <sub>smax</sub> )	6°C/second max.
Time 25°C to peak temperature	8 minutes max.

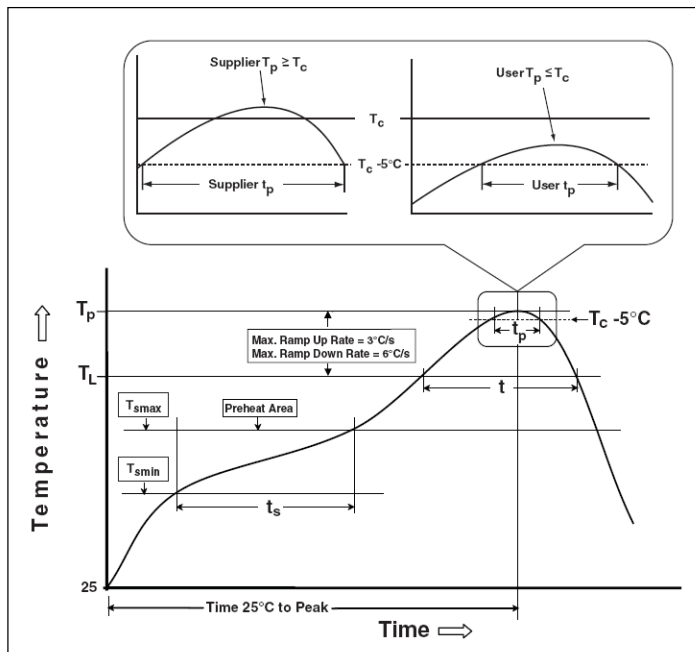
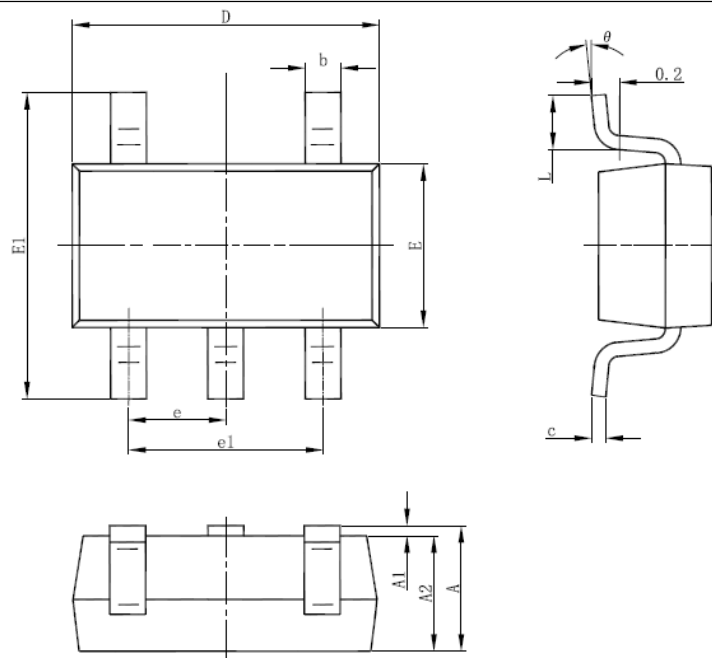

Figure 19 Classification Profile

## PACKAGING INFORMATION

### SOT23-5



Symbol	Dimensions In Millimeters		Dimensions In Inches	
	Min	Max	Min	Max
A	1.050	1.250	0.041	0.049
A1	0.000	0.100	0.000	0.004
A2	1.050	1.150	0.041	0.045
b	0.300	0.500	0.012	0.020
c	0.100	0.200	0.004	0.008
D	2.820	3.020	0.111	0.119
E	1.500	1.700	0.059	0.067
E1	2.650	2.950	0.104	0.116
e	0.950(BSC)		0.037(BSC)	
e1	1.800	2.000	0.071	0.079
L	0.300	0.600	0.012	0.024
θ	0°	8°	0°	8°