



Chipsmall Limited consists of a professional team with an average of over 10 year of expertise in the distribution of electronic components. Based in Hongkong, we have already established firm and mutual-benefit business relationships with customers from,Europe,America and south Asia,supplying obsolete and hard-to-find components to meet their specific needs.

With the principle of "Quality Parts,Customers Priority,Honest Operation,and Considerate Service",our business mainly focus on the distribution of electronic components. Line cards we deal with include Microchip,ALPS,ROHM,Xilinx,Pulse,ON,Everlight and Freescale. Main products comprise IC,Modules,Potentiometer,IC Socket,Relay,Connector.Our parts cover such applications as commercial,industrial, and automotives areas.

We are looking forward to setting up business relationship with you and hope to provide you with the best service and solution. Let us make a better world for our industry!



## Contact us

Tel: +86-755-8981 8866 Fax: +86-755-8427 6832

Email & Skype: info@chipsmall.com Web: www.chipsmall.com

Address: A1208, Overseas Decoration Building, #122 Zhenhua RD., Futian, Shenzhen, China



# ISL1903DEMO1Z: Offline Triac Dimmable LED Driver

## Introduction

ISL1903DEMO1Z evaluation board converts a low line AC input voltage (120V) to a 42V, 350mA constant current output to drive LEDs. It is implemented with Intersil's critical conduction mode (CrCM) single ended buck controller, the ISL1903. It demonstrates fundamental functions of the ISL1903, including soft-start, triac dimming, overvoltage protection, short circuit protection, etc. The circuit operates in CrCM with variable frequency and allows for near zero-voltage switching (ZVS). Typical efficiency is about 87% at full load. This application note covers the test setup, performance data, dimming data, schematics, layout and BOM.

## Design Specifications

- Input voltage  $V_{IN}$ : 96V to 144V
- Output voltage  $V_O$ : 28V to 42V
- Output current  $I_O$ : 350mA (14W)
- Board dimensions:  $55 \times 26 \times 15 \text{mm}^3$  (L×W×H)
- Input power factor greater than 0.95
- Total harmonic distortion less than 15%
- Peak efficiency at full load: 87%
- 0-100% dimming with leading and trailing edge dimmers

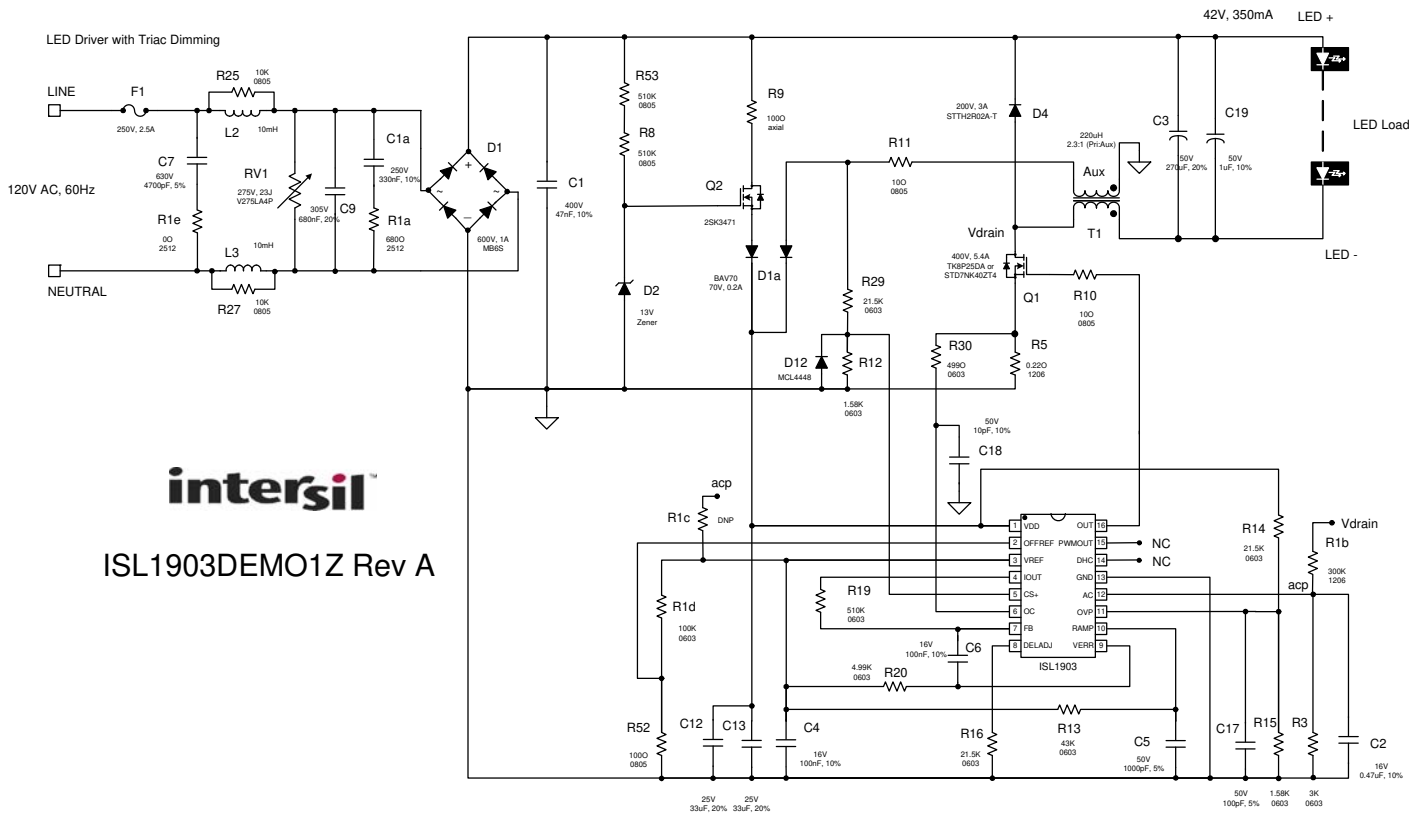

intersil™  
ISL1903DEMO1Z Rev A

FIGURE 1. AC BUCK CONVERTER APPLICATION SCHEMATIC

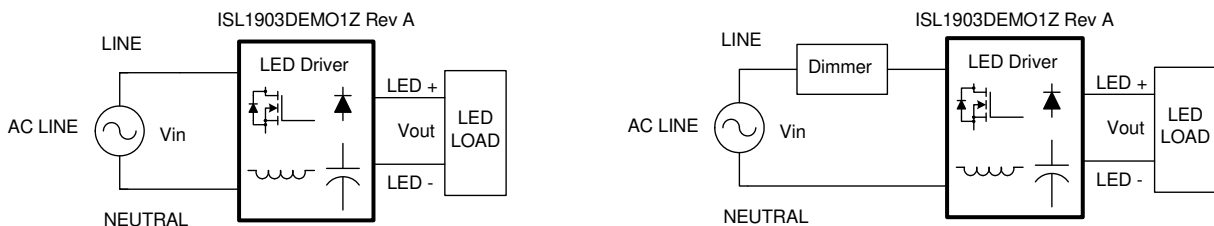

FIGURE 2. TEST SETUP WITH AND WITHOUT DIMMING

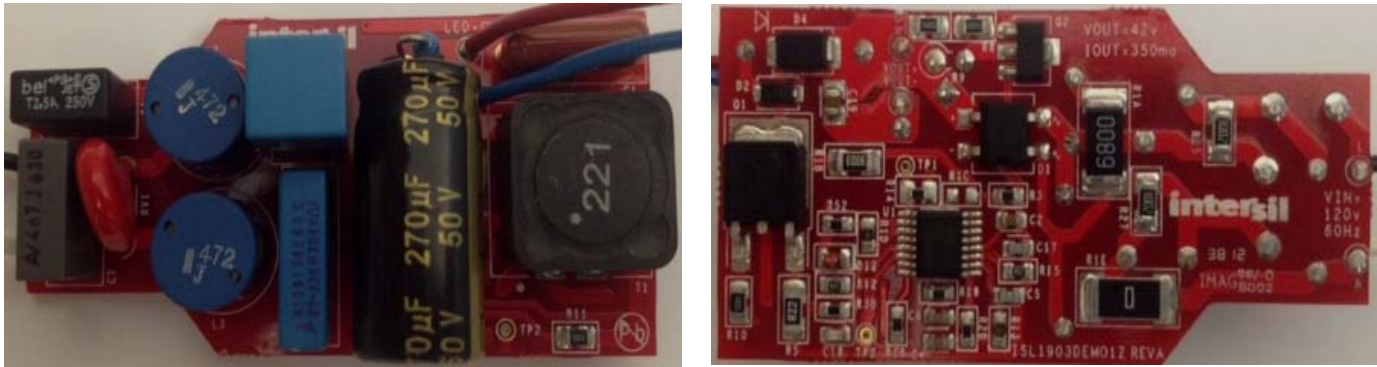

FIGURE 3. TOP/BOTTOM VIEW OF THE EVALUATION BOARD

## Schematic Description

The ISL1903 is a high-performance, critical conduction mode (CrCM), single-ended buck LED driver controller. It supports single-stage conversion of the AC mains to a constant current source with power factor correction (PFC). It also may be used with DC input converters. The ISL1903 supports buck converter topologies, such as isolated forward converters or non-isolated source return buck converters. Operation in CrCM allows near zero-voltage switching (ZVS) for improved efficiency while maximizing magnetic core utilization. The ISL1903 LED driver provides all of the features required for high-performance dimmable LED ballast designs.

### Input EMI Filtering

Inductors L2, L3 and capacitors C7, C9 filter the switching current to the AC line. Resistors R25, R27 dampen the resonance of the EMI filter, preventing peaks in the conducted EMI spectrum.

MOV RV1 clamps the maximum line voltages during line surge events. Bridge rectifier D1 rectifies the AC line voltage. Fuse F1 provides overload protection from the AC mains.

### Start-up Network

R8, R53, R9, Q2 and D2 constitute the linear regulator circuit which is used during startup. Once the energy is built and voltage is generated on the aux winding, the linear regulator circuit is disabled and the auxiliary winding supplies the VDD and current to the IC.

### Power Stage

Q1, D4, T1 (coupled inductor) and C3 are the AC buck converter components. The source of the main MOSFET Q1 is tied to ground and a high voltage level shifter is not needed as is the case in a buck converter.

Near zero voltage switching (ZVS) or quasi-resonant switching, as it is sometimes referred to, can be achieved in the buck topology by delaying the next switching cycle after the inductor current decays to zero (critical conduction mode). The delay allows the inductance and parasitic capacitance to oscillate, causing the switching FET drain-source voltage to ring down to minima. If the FET is turned on at this minima, the capacitive switching losses ( $\frac{1}{2}CV^2$ ) are greatly reduced.

## Inductance Calculation

TABLE 1. BUCK CONVERTER ELECTRICAL PARAMETERS

NAME	VALUE
$V_{INmin(rms)}$	96V
$V_{INmax(rms)}$	144V
$V_{OUT}$	42V
$I_{OUT}$	350mA
$F_{min(avg)}$	90kHz

Inductance value is important in operating the buck converter in critical conduction mode. The desired inductance is calculated using Equation 1:

$$L = \frac{V_{OUT}(V_{IN(rms)} - V_{OUT})}{2 \times f_{min} \times I_{OUT} \times V_{IN(rms)} \times \sqrt{2}} \quad H \quad (EQ. 1)$$

where  $V_{OUT}$  is the LED string voltage,  $V_{IN}$  is the rms input voltage,  $I_{OUT}$  is the current through the LED string and  $f_{min}$  is the chosen minimum frequency at minimum  $V_{IN}$ . Plugging in the values from Table 1 into Equation 1 provides:

$$L = \frac{42(96 - 42)}{2 \times 90k \times 0.35 \times 96 \times \sqrt{2}} \quad H = 265\mu H \quad (EQ. 2)$$

The above equation calculates the required inductance when operating at the DC equivalent input voltage. It does not take into account the reduction in conduction angle that occurs when the instantaneous input voltage is less than the output voltage. Equation 3 corrects for this.

$$L_{buck} = L \times \frac{\pi - 2 \times \arcsin\left(\frac{V_{OUT}}{V_{IN} \times \sqrt{2}}\right)}{\pi} \quad H \quad (EQ. 3)$$

$$L_{buck} = 265\mu H \times \frac{\pi - 2 \times \arcsin\left(\frac{42}{96 \times \sqrt{2}}\right)}{\pi} = 239\mu H$$

220µH inductor is selected for this application.

The auxiliary winding is used to detect inductor zero-current for critical conduction mode operation. R29, R12 and D12 scale down the sensed zero crossing voltage and applied to the IC. Deladj sets delay before a new switching cycles starts. This adjustment allows the user to delay the next switching cycle until the switching FET drain-source voltage reaches a minimum value to allow quasi-ZVS (Zero Voltage Switching) operation. Resistor R16 to ground programs the delay.

## Performance Data

**TABLE 2. PERFORMANCE DATA - 14 LED LOAD**

V <sub>IN</sub> (V)	P <sub>IN</sub> (W)	V <sub>O</sub> (V)	I <sub>O</sub> (mA)	P <sub>O</sub> (W)	PF (V/V)	THD (%)	η (%)
90	15.79	40.89	332.79	13.61	0.983	16.32	86.20
100	15.61	40.88	331.10	13.54	0.985	13.62	86.72
110	15.55	40.88	330.53	13.51	0.986	11.68	86.92
120	15.58	40.88	330.63	13.52	0.98	10.17	86.77
130	15.60	40.88	331.16	13.54	0.98	9.12	86.76
140	15.67	40.88	332.00	13.57	0.98	8.35	86.60

**TABLE 4. PERFORMANCE DATA - 10 LED LOAD**

V <sub>IN</sub> (V)	P <sub>IN</sub> (W)	V <sub>O</sub> (V)	I <sub>O</sub> (mA)	P <sub>O</sub> (W)	PF (V/V)	THD (%)	η (%)
90	11.44	29.43	332.90	9.8	0.99	9.8	85.61
100	11.40	29.43	332.50	9.78	0.99	9.10	85.81
110	11.42	29.42	332.64	9.79	0.98	8.98	85.68
120	11.46	29.42	333.24	9.8	0.98	9.10	85.54
130	11.52	29.42	334.15	9.83	0.97	9.38	85.35
140	11.61	29.42	335.26	9.86	0.96	9.41	84.97

**TABLE 3. PERFORMANCE DATA - 12 LED LOAD**

V <sub>IN</sub> (V)	P <sub>IN</sub> (W)	V <sub>O</sub> (V)	I <sub>O</sub> (mA)	P <sub>O</sub> (W)	PF (V/V)	THD (%)	η (%)
90	13.67	35.30	333.84	11.79	0.99	12.69	86.24
100	13.59	35.29	332.8	11.75	0.99	10.87	86.42
110	13.58	35.28	332.55	11.73	0.99	9.63	86.39
120	13.59	35.27	332.90	11.74	0.98	8.77	86.40
130	13.64	35.26	333.62	11.77	0.98	8.60	86.24
140	13.75	35.26	334.54	11.8	0.97	8.38	85.80

## Performance Curves

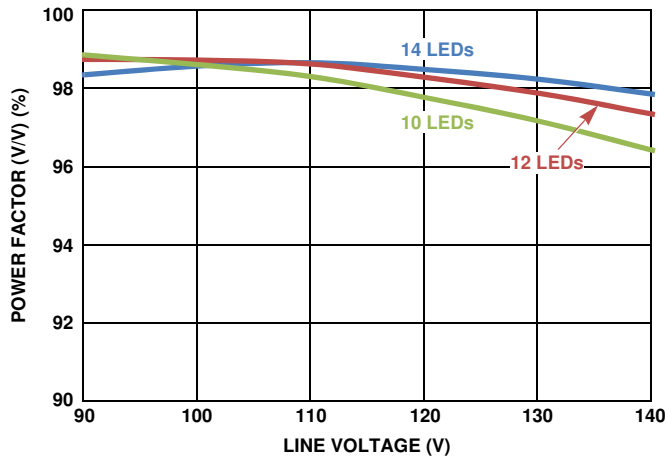

**FIGURE 4. POWER FACTOR vs LINE VOLTAGE**

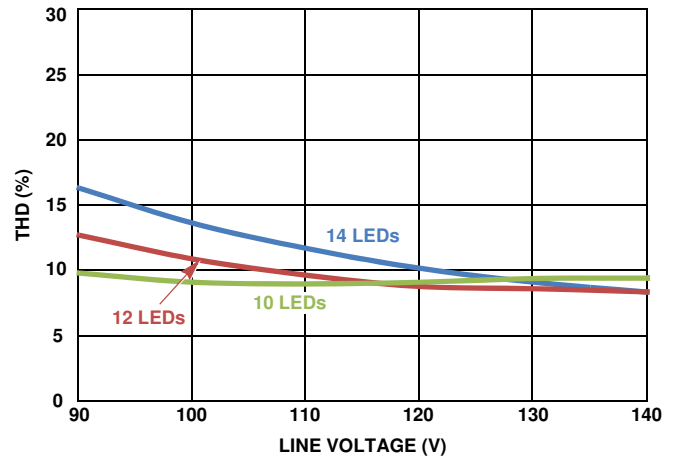

**FIGURE 5. THD WITH LINE VARIATION**

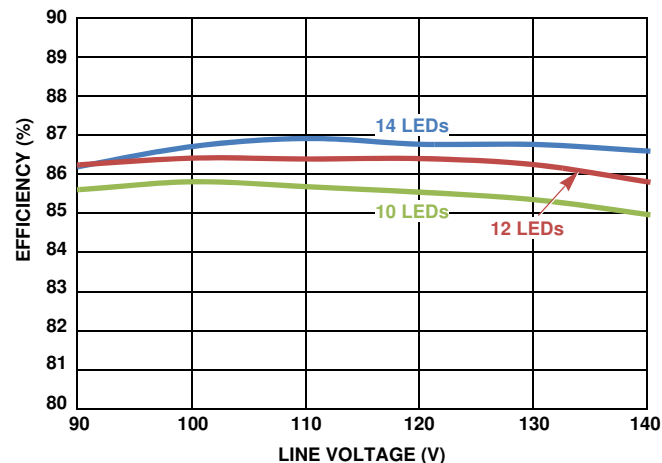

**FIGURE 6. EFFICIENCY vs LINE VOLTAGE**

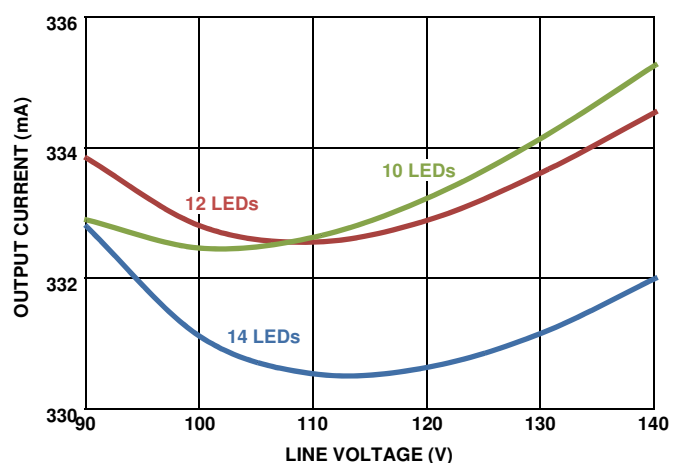

**FIGURE 7. OUTPUT CURRENT VARIATION WITH LINE**

## Key Waveforms

WAVEFORMS DEPICTING INPUT VOLTAGE AND CURRENT

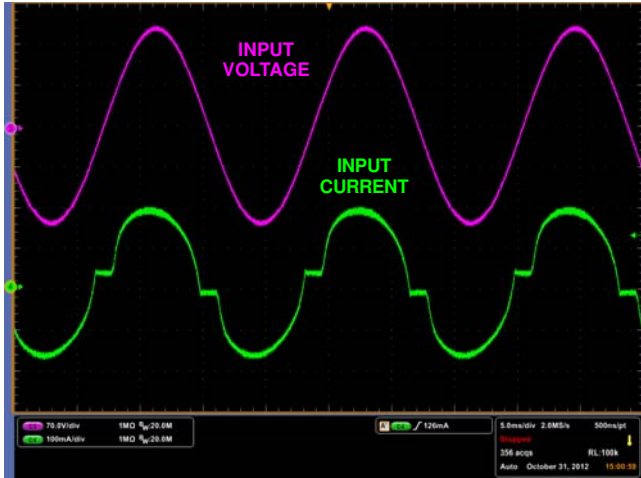

FIGURE 8. INPUT VOLTAGE AND CURRENT WAVEFORMS WITH NO DIMMER CONNECTED; TRACE 3: INPUT VOLTAGE (70V/DIV); TRACE 4: INPUT CURRENT (100mA/DIV)

INPUT VOLTAGE AND CURRENT DURING STARTUP

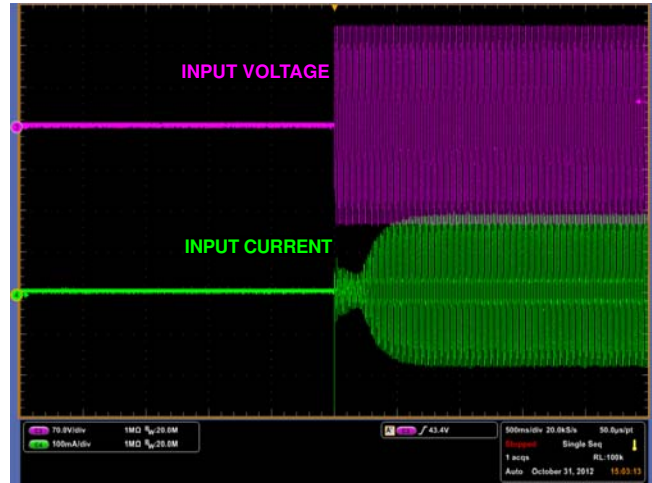

FIGURE 9. INPUT VOLTAGE AND CURRENT DURING STARTUP; TRACE 3: INPUT VOLTAGE (70V/DIV); TRACE 4: INPUT CURRENT (100mA/DIV)

OUTPUT VOLTAGE AND CURRENT DURING STARTUP

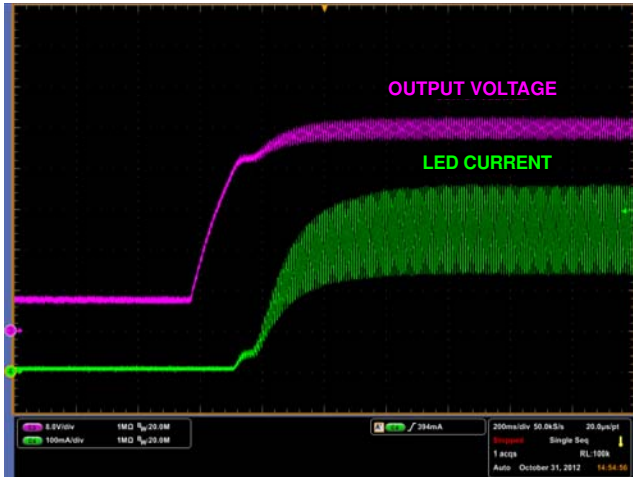

FIGURE 10. OUTPUT VOLTAGE AND CURRENT DURING STARTUP; TRACE 3: OUTPUT VOLTAGE (8V/DIV); TRACE 4: OUTPUT CURRENT (100mA/DIV)

LED CURRENT RIPPLE

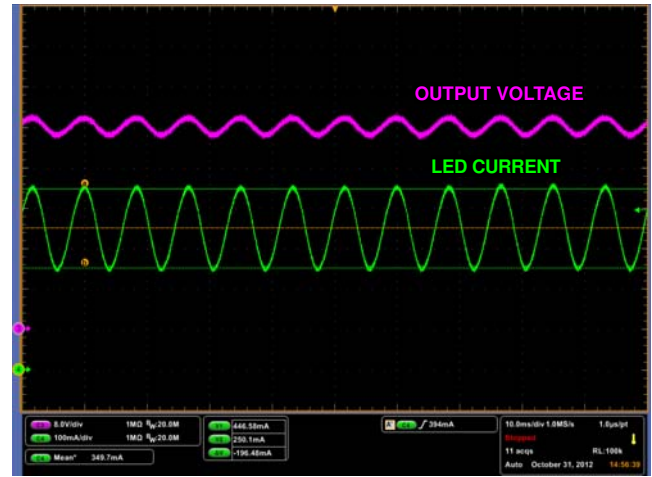
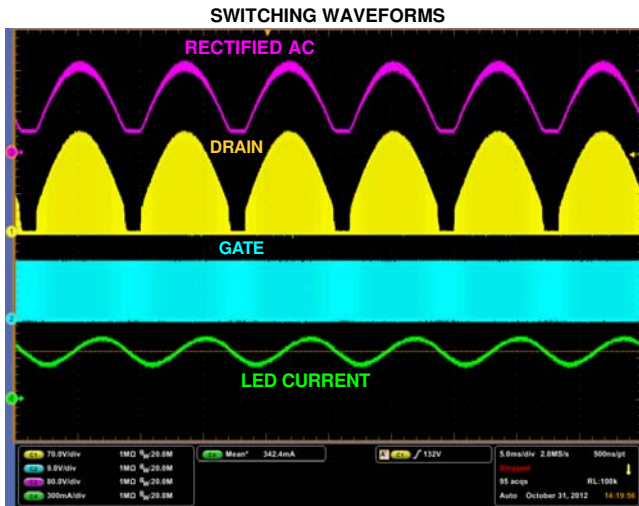
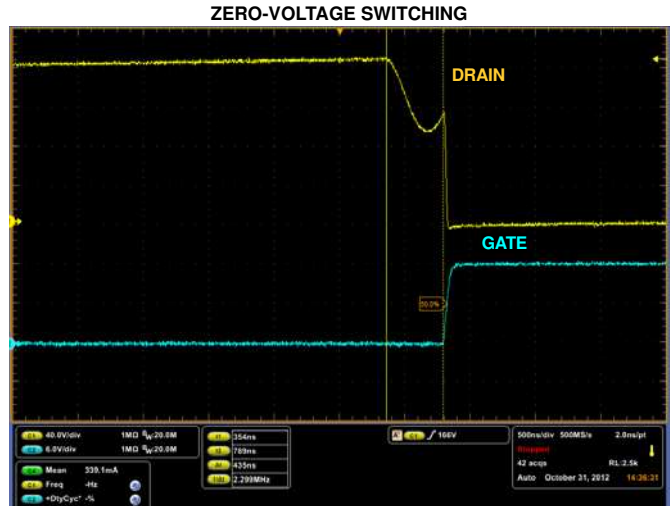

FIGURE 11. OUTPUT VOLTAGE AND CURRENT; TRACE 3: OUTPUT VOLTAGE (8V/DIV); TRACE 4: OUTPUT CURRENT (100mA/DIV)

## Key Waveforms (Continued)



**FIGURE 12.** TRACE 1: DRAIN VOLTAGE (70V/DIV); TRACE 2: GATE VOLTAGE (9V/DIV); TRACE 3: RECTIFIED AC VOLTAGE (80V/DIV); TRACE 4: OUTPUT CURRENT (300mA/DIV)



**FIGURE 13.** TRACE 1: DRAIN VOLTAGE (60V/DIV); TRACE 2: GATE VOLTAGE (7V/DIV)

## Dimming Compatibility

The requirement to provide dimming with low cost, triac based dimmers introduced trade-offs in the design. Due to lower power consumption by LED lighting, the input current drawn by the lamp during triac based dimming is below the holding current of triac dimmers. This causes the triac to trigger inconsistently and causes flickering and/or limited dimming range. Large impedance presented to the line by the LED driver allows significant ringing to occur due to inrush current charging the input capacitance when triac turns on. This can cause undesirable operation as the ringing may cause the triac current to fall to zero and turn off prematurely.

To overcome these issues, an active dimmer current holding circuit (DHC pin, R17) and a passive damping circuit (C1a, R1a) are incorporated into the design. These circuits result in increased power dissipation and hence reduce electrical efficiency and overall lamp efficacy. For non-dimming applications, these circuits can be omitted.

ISL1903EVAL1Z evaluation board has been tested against the following common dimmers available in the market.

1. Leviton 6602-1W
2. Leviton Truetouch TT106-1
3. Lutron DVCL-153P
4. Lutron CTCL-153P
5. Leviton Decora slide dimmer
6. Lutron Skylar S-600

**TABLE 5. DIMMING DATA**

CONDUCTION ANGLE (%)	OUTPUT CURRENT (mA)	% OF OUTPUT CURRENT MEASURED (%)	% OF OUTPUT CURRENT AS PERCEIVED BY HUMAN EYE (%)
100	348	100.0	100.0
90	348	100.0	100.0
85.2	348	100.0	100.0
80.62	348	100.0	100.0
64.2	247	70.98	84.25
50.4	158	45.4	67.38
39.12	106	30.46	55.19
32.16	75	21.55	46.42
26.16	46	13.22	36.36
13.44	7.7	2.21	14.87
12	1.6	0.46	6.78
8.4	0	0	0
0	0	0	0

## Dimming Curve

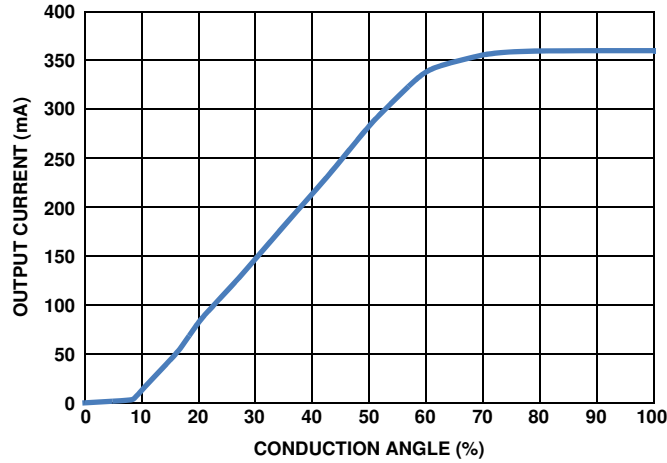

FIGURE 14. DIMMING CURVE - LEADING EDGE DIMMER

## Dimming Waveforms

WAVEFORM SHOWING LINE VOLTAGE AND CURRENT;  
CONDUCTION ANGLE: 85.2%

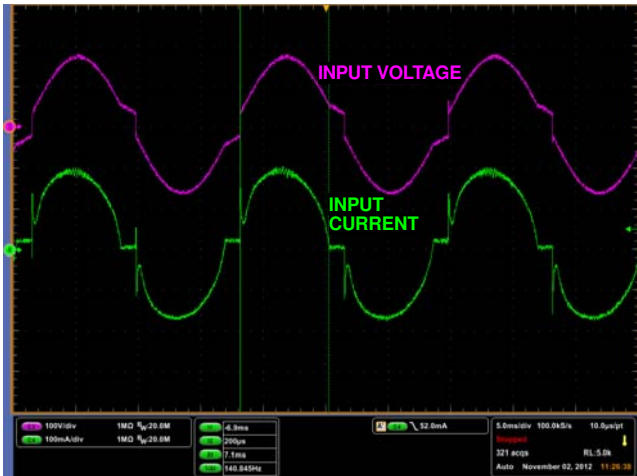

FIGURE 15. TRACE 3: INPUT VOLTAGE (100V/DIV);  
TRACE 4: INPUT CURRENT (100mA/DIV)

WAVEFORM SHOWING LINE VOLTAGE AND CURRENT;  
CONDUCTION ANGLE: 57.2%

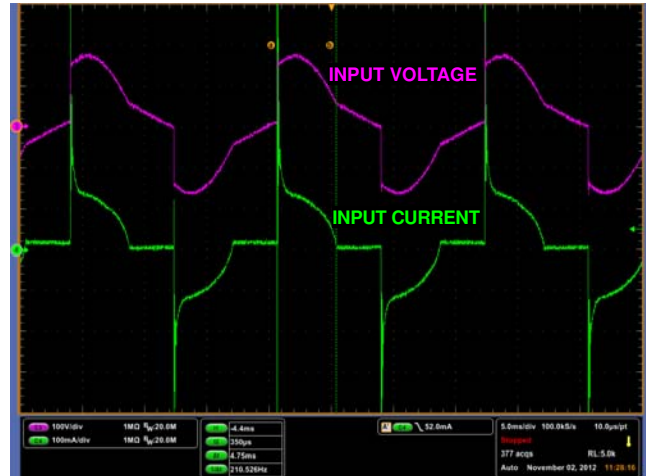

FIGURE 16. TRACE 3: INPUT VOLTAGE (100V/DIV);  
TRACE 4: INPUT CURRENT (100mA/DIV)

## Dimming Waveforms (Continued)

WAVEFORM SHOWING LINE VOLTAGE AND CURRENT;  
CONDUCTION ANGLE: 34.09%

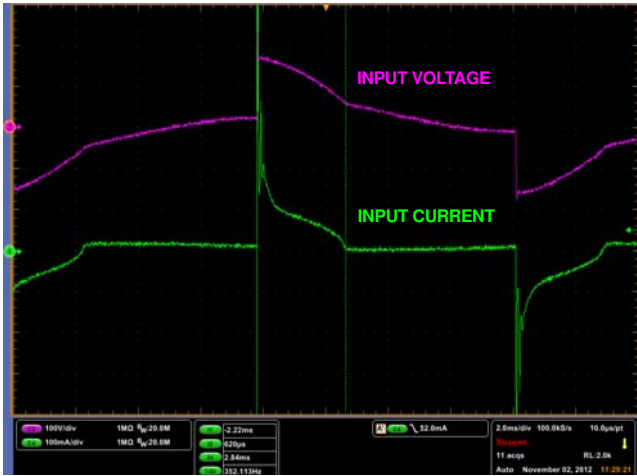

FIGURE 17. TRACE 3: INPUT VOLTAGE (100V/DIV);  
TRACE 4: INPUT CURRENT (100mA/DIV)

WAVEFORM SHOWING LINE VOLTAGE AND CURRENT;  
CONDUCTION ANGLE: 21.6%

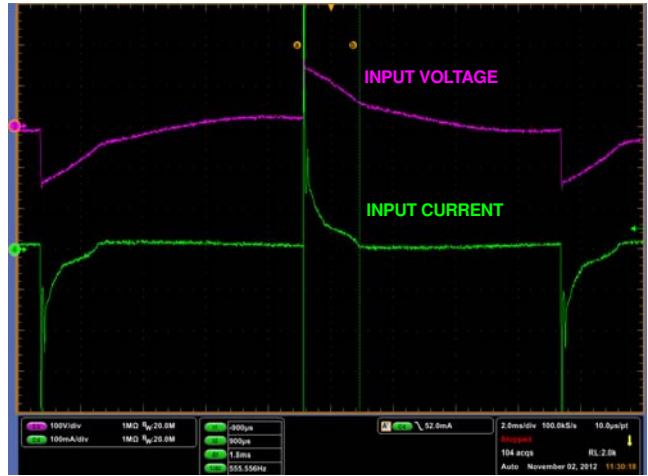

FIGURE 18. TRACE 3: INPUT VOLTAGE (100V/DIV);  
TRACE 4: INPUT CURRENT (100mA/DIV)

WAVEFORM SHOWING LINE VOLTAGE AND CURRENT;  
CONDUCTION ANGLE: 12.96%

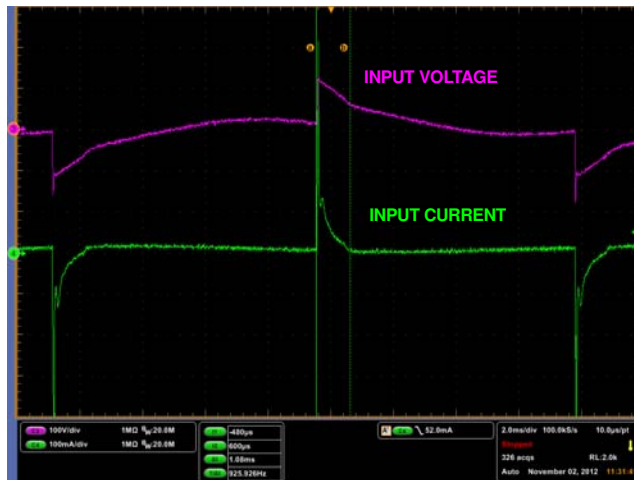

FIGURE 19. TRACE 3: INPUT VOLTAGE (100V/DIV); TRACE 4: INPUT CURRENT (100mA/DIV)



## Overvoltage Protection

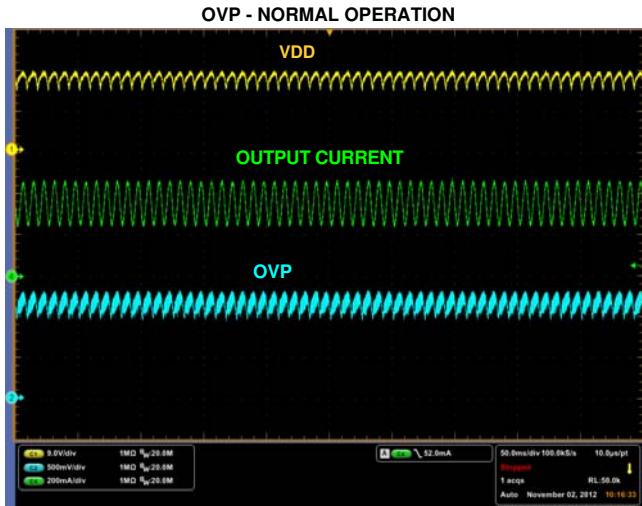

FIGURE 20. TRACE 1: VDD (9V/DIV); TRACE 2: OVP (500mV/DIV); TRACE 4: LED CURRENT (200mA/DIV)

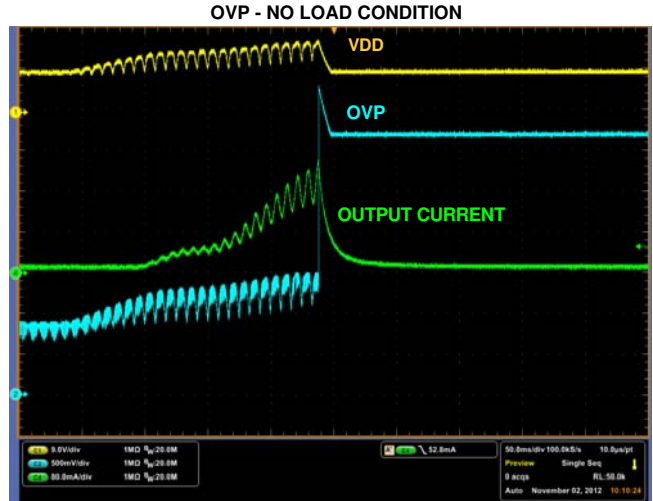

FIGURE 21. TRACE 1: VDD (9V/DIV); TRACE 2: OVP (500mV/DIV); TRACE 4: LED CURRENT (80mA/DIV)

## Short Circuit Protection

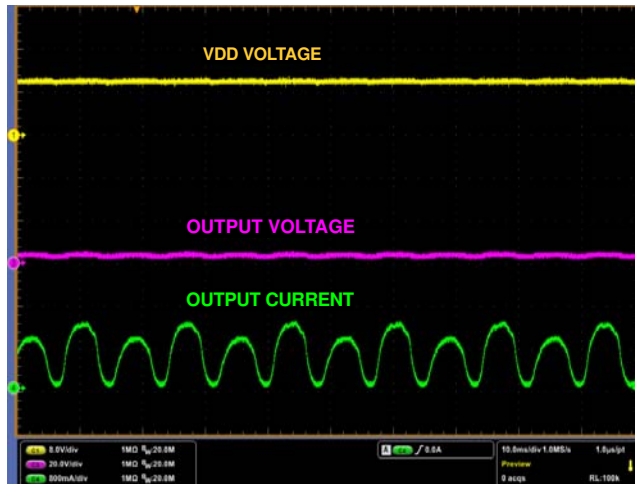
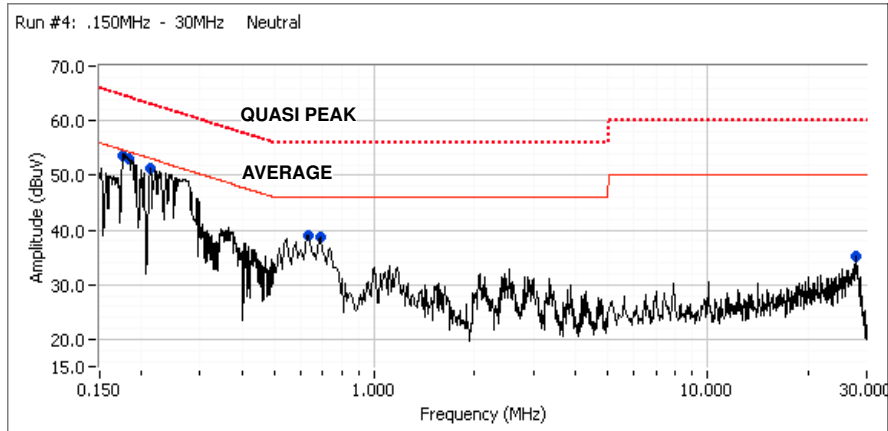
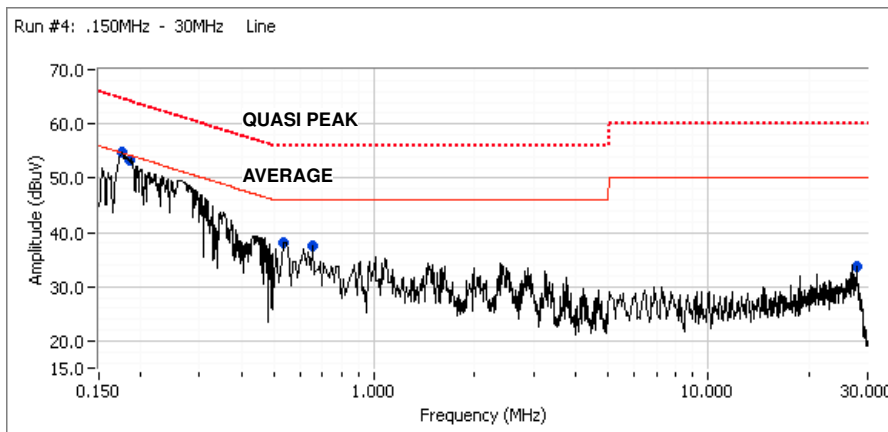

FIGURE 22. TRACE 1: VDD (8V/DIV); TRACE 3: OUTPUT VOLTAGE (20V/DIV); TRACE 4: LED CURRENT (800mA/DIV)

## EMI Results - Cispr 22 Class B



**FIGURE 23. LINE AT 120V, 60Hz**



**FIGURE 24. NEUTRAL AT 120V, 60Hz**

**TABLE 6. QUASI PEAK AND AVERAGE READINGS**

FREQUENCY (MHz)	LEVEL (dB $\mu$ V)	AC LINE	CLASS B		DETECTOR (QP/AVG)
			LIMIT	MARGIN	
0.175	53.5	Line 1	64.7	-11.2	QP
0.175	52.9	Neutral	64.7	-11.8	QP
0.183	51.8	Neutral	64.3	-12.5	QP
0.185	51.6	Line 1	64.3	-12.7	QP
0.175	39.4	Line 1	54.7	-15.3	AVG
0.175	38.7	Neutral	54.7	-16.0	AVG
0.213	46.9	Neutral	63.1	-16.2	QP
0.183	37.5	Neutral	54.3	-16.8	AVG
0.541	37.5	Line 1	56.0	-18.5	QP
0.185	35.4	Line 1	54.3	-18.9	AVG
0.635	35.7	Line 1	56.0	-20.3	QP
0.541	21.1	Line 1	46.0	-24.9	AVG
0.635	20.8	Line 1	46.0	-25.2	AVG
0.213	24.5	Neutral	53.1	-28.6	AVG
27.809	20.4	Neutral	50.0	-29.6	AVG
27.840	18.7	Line 1	50.0	-31.3	AVG
27.809	28.4	Neutral	60.0	-31.6	QP
27.840	26.9	Line 1	60.0	-33.1	QP

## Temperature Mapping

The following pictures show the temperature of ISL1903 evaluation board.

Operating conditions:  $V_{IN} = 120V$ ,  $T_A = +25^\circ C$ ,  $V_{OUT} = 42V$ ,  $I_{OUT} = 350mA$

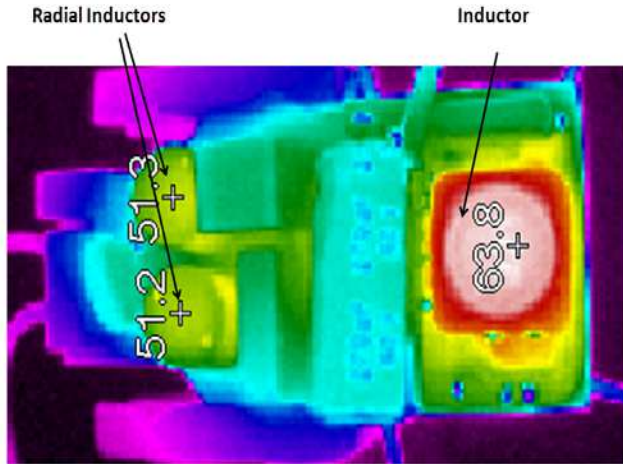

FIGURE 25. TOP SIDE TEMPERATURE SNAPSHOT DURING 100% CONDUCTION AND FULL LOADING

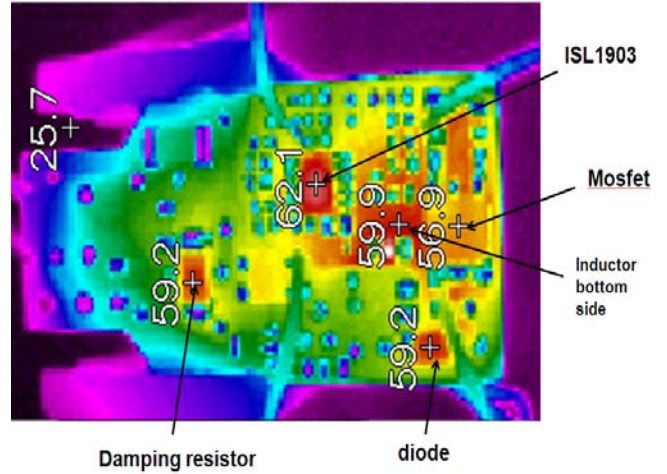
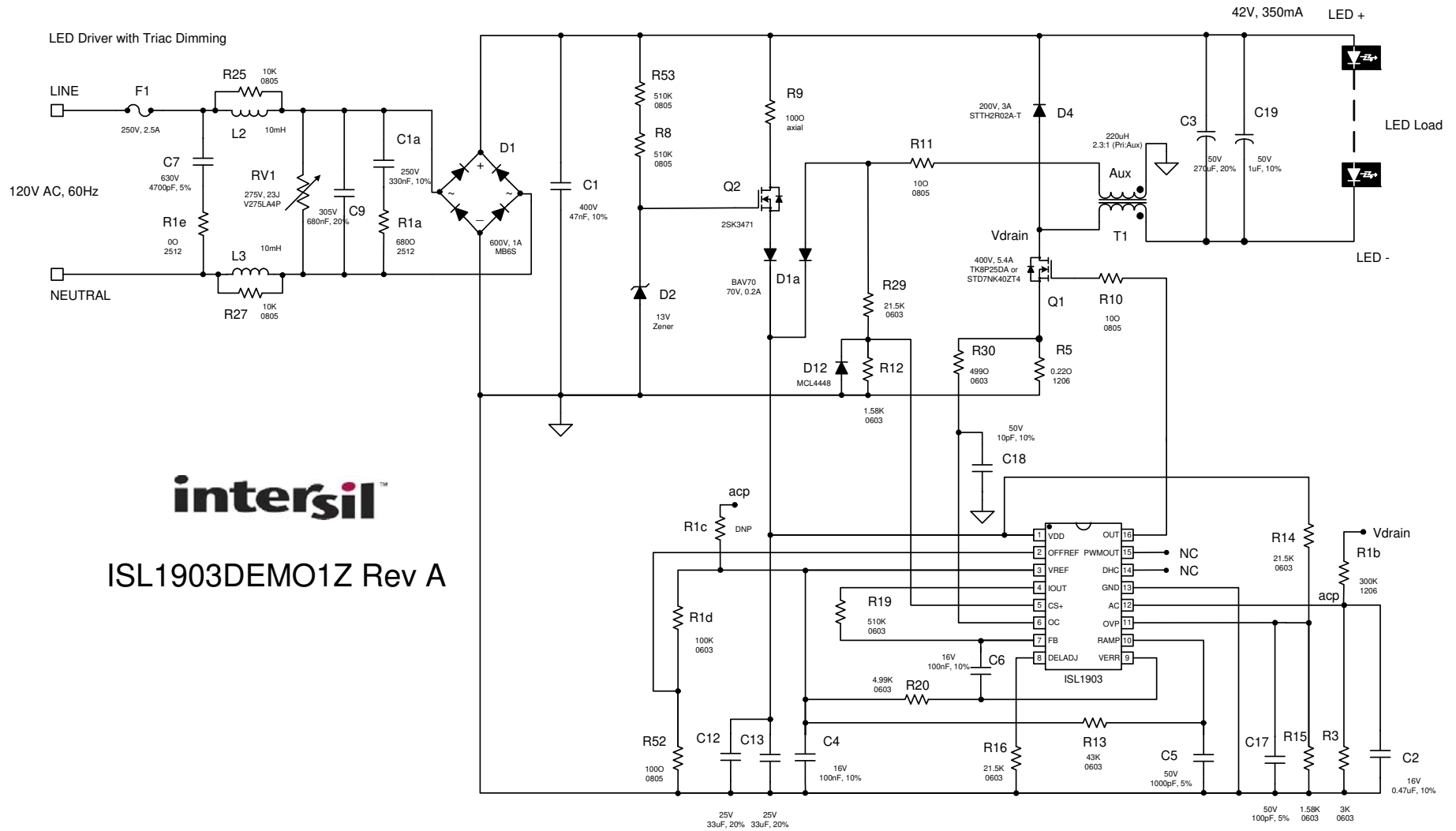

FIGURE 26. BOTTOM SIDE TEMPERATURE SNAPSHOT DURING 100% CONDUCTION AND FULL LOADING

# Application Schematic



**intersil**

ISL1903DEMO1Z Rev A

# Application Note 1854

## Bill of Materials

**TABLE 7. BOM FOR ISL1903DEMO1Z REV. A**

QTY	REFERENCE DESIGNATOR	TYPE/MOUNT/PACKAGE/VOL/TOL/MAT	MANUFACTURER	MANUFACTURER PART #
1	C1	Cap, Radial, 47n, 400V, 10%, FILM	PANASONIC	ECQE4473KF
1	C1a	Cap, TH, 330n, 250V, 20%, MKT	EPCOS	B32529C3334K000
1	C9	Cap, Radial, 0.033 $\mu$ , 305V, 20%, MKT	EPCOS	B32921C3333M
1	C2	Cap, SM, 0603, 470n, 16V, 10%, X7R	TDK	C1608X7R1C474K
2	C4, C6	Cap, SM, 0603, 0.1 $\mu$ , 16V, 10%, X7R	MURATA	GRM39X7R104K016AD
1	C5	Cap, SM, 0603, 1000p, 50V, 5%, COG	MURATA	GRM1885C1H102JA01D
1	C17	Cap, SM, 0603, 100p, 50V, 5%, COG	PANASONIC	ECJ-1VC1H101J
1	C18	Cap, SM, 0603, 10p, 50V, 5%, COG	YAGEO	CC0603JRNPO9BN100
2	C12, C13	Cap, SM, 1206, 33 $\mu$ , 25V, 20%, X5R	TDK	C3216X5R1E336M
1	C7	Cap, RADIAL, 10X4mm, 4700p, 630V, 5%, FILM	KEMET	R76PD1470SE40J
1	C3	Cap, RADIAL, 10x20, 270 $\mu$ , 50V, 20%, ALUM	PANASONIC	EEU-FM1H271
1	C19	Cap, SM, 0805, 1 $\mu$ , 50V, 10%, X7R	Murata	GRM21BR71H105KA12L
1	D1a	Diode, SM, SOT23, 150mA, 75V, Switching	MICRO COM	BAV70-TP
1	D1	Diode, SMD, $\Phi$ 4.2X4.9, 600V, 0.5A, Rectifier	MICRO COM	MB6S-TP
1	D2	Diode, SMD, SOD-123, 13V, 500mW, zener	FAIRCHILD	MMSZ5243B
1	D12	Diode, SMD, MICROMELF, 100V, 200mA, Small signal	VISHAY	MCL4448-TR
1	D4	Diode, SM, SMA, 200V, 2A, Fast Recovery	STM	STTH2R02A
1	T1	Coupled Inductor, SM, 220 $\mu$ H	Renco	RLIN1000
2	L2, L3	Inductor, Radial, 10mH	Renco	RL-5480-3-10000
1	F1	Fuse, Radial, 250V, 2.5A	Bel Fuse	RST 2.5
1	U1	IC, ISL1903 16Pin, QSOP	INTERSIL	ISL1903FAZ
1	Q1	MOSFET, SM, DPAK, 250V, 7.5A	Toshiba/STM	TK8P25DA/STD7NK40ZT4
2	Q2	MOSFET, SM, SOT89, 500V, 0.5A	Toshiba	2SK3471
1	R1a	Res, SM, 2512, 680, 1%, Thick Film	VISHAY	CRCW2512680RFKEG
1	R1b	Res, SM, 1206, 300k, 1%, Thick Film	YAGEO	RC1206FR-07300KL
1	R1c	Res, SM, 0603, 0, 1%, Thick Film	DNP	DNP
2	R1d, R15	Res, SM, 0603, 100k, 1%, Thick Film	VENKEL	CR0603-10W-1003FT
1	R3	Res, SM, 0603, 3k, 1%, Thick Film	YAGEO	RC0603FR-073KL
1	R5	Res, SM, 1206, 0.22, 1%, Thick Film	PANASONIC	ERJ-8RQFR22V
1	R8, R53	Res, SM, 1206, 510k, 1%, Thick Film	VENKEL	CR1206-4W-5103FT
1	R9	Res, SM, 1206, 200, 1%, Thick Film Res, TH, 200, 1% - substitution for SM	YAGEO	MFR-25FBF-100R
2	R10, R11	Res, SM, 0805, 10, 1%, Thick Film	VENKEL	CR0805-8W-10R0FT
1	R12	Res, SM, 0603, 1.58k, 1%, Thick Film	VENKEL	CR0603-10W-1581FT
1	R13	Res, SM, 0603, 43k, 1%, Thick Film	VENKEL	C0603-10W-4302FT
1	R14	Res, SM, 0603, 1.2Meg, 1%, Thick Film	PANASONIC	ERJ-3EKF1204V
2	R16, R29	Res, SM, 0603, 21.5k, 1%, Thick Film	VENKEL	CR0603-10W-2152FT
1	R1e	Res, SM, 2512, 0, 1%, Thick Film	VENKEL	CR2512-1W-000T
1	R19	Res, SM, 0603, 510k, 1%, Thick Film	PANASONIC	ERJ-3EKF5103V
1	R20	Res, SM, 0603, 4.99k, 1%, Thick Film	PANASONIC	ERJ-3EKF4991V
2	R25, R27	Res, SM, 1206, 10k, 1%, Thick Film	VENKEL	CR1206-4W-1002FT
1	R30	Res, SM, 0603, 499, 1%, Thick Film	VENKEL	CR0603-10W-4990FT
1	R52	Res, SM, 0603, 100, 1%, Thick Film	VENKEL	CR0603-10W-1000FT
1	RV1	Varistor, Radial, 7mm, 275V, 23J, 1.2kA, TVS	LITTLEFUSE	V275LA4P

Assembly Drawing

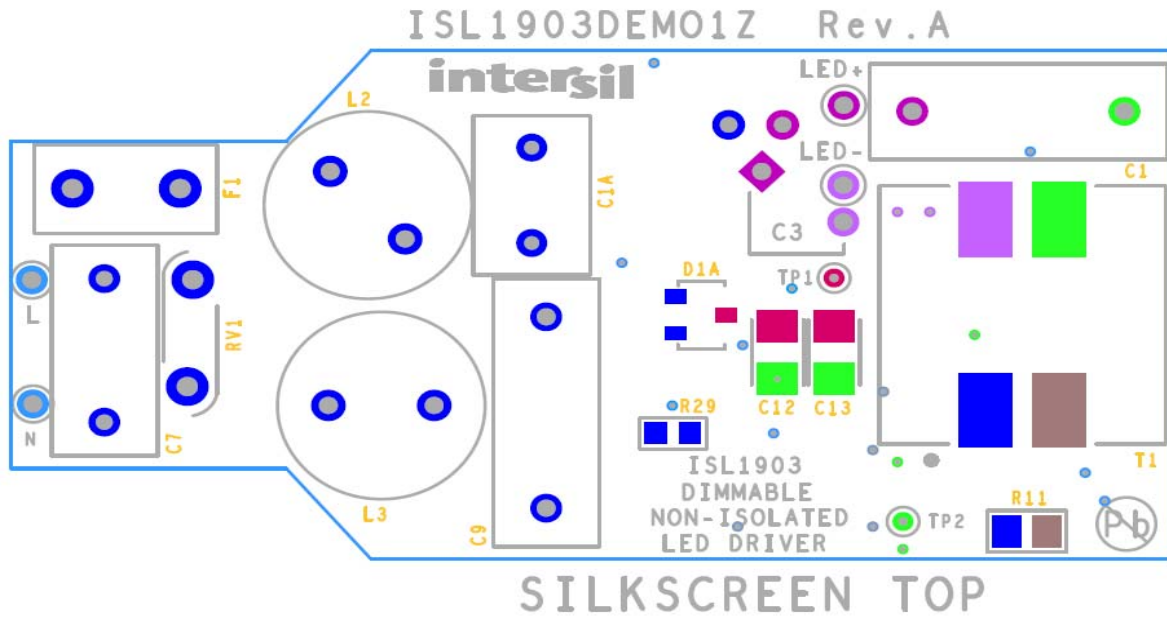

FIGURE 27. SILKSCREEN TOP

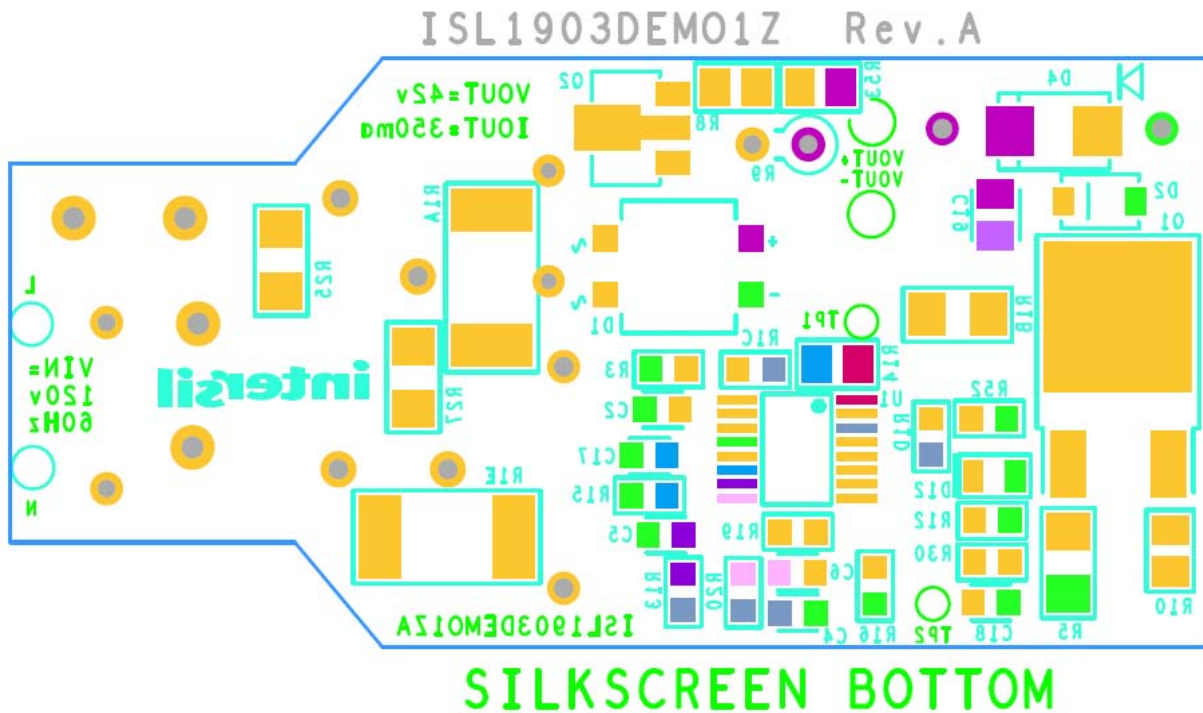

FIGURE 28. SILKSCREEN BOTTOM

Intersil Corporation reserves the right to make changes in circuit design, software and/or specifications at any time without notice. Accordingly, the reader is cautioned to verify that the Application Note or Technical Brief is current before proceeding.

For information regarding Intersil Corporation and its products, see [www.intersil.com](http://www.intersil.com)