



Chipsmall Limited consists of a professional team with an average of over 10 year of expertise in the distribution of electronic components. Based in Hongkong, we have already established firm and mutual-benefit business relationships with customers from,Europe,America and south Asia,supplying obsolete and hard-to-find components to meet their specific needs.

With the principle of “Quality Parts,Customers Priority,Honest Operation,and Considerate Service”,our business mainly focus on the distribution of electronic components. Line cards we deal with include Microchip,ALPS,ROHM,Xilinx,Pulse,ON,Everlight and Freescale. Main products comprise IC,Modules,Potentiometer,IC Socket,Relay,Connector.Our parts cover such applications as commercial,industrial, and automotives areas.

We are looking forward to setting up business relationship with you and hope to provide you with the best service and solution. Let us make a better world for our industry!



## Contact us

Tel: +86-755-8981 8866 Fax: +86-755-8427 6832

Email & Skype: info@chipsmall.com Web: www.chipsmall.com

Address: A1208, Overseas Decoration Building, #122 Zhenhua RD., Futian, Shenzhen, China



### Light-to-Digital Output Sensor with High Sensitivity, Gain Selection, Interrupt Function and I<sup>2</sup>C Bus™

The ISL29012 is an integrated light sensor with I<sup>2</sup>C (SMBus Compatible) interface. It has an internal signed 15-bit integrating type ADC designed based on the charge-balancing A/D conversion technique. This ADC is capable of rejecting 50Hz and 60Hz flicker caused by artificial light sources. The lux range select feature allows the user to program the lux range for optimized counts/lux.

In normal operation, power consumption is typically 250µA. Furthermore, a power-down mode can be controlled by software via the I<sup>2</sup>C interface, reducing power consumption to less than 1µA.

The ISL29012 supports a hardware interrupt that remains asserted low until the host clears it through I<sup>2</sup>C interface.

Designed to operate on supplies from 2.5V to 3.3V, the ISL29012 is specified for operation over the -40°C to +85°C ambient temperature range.

### Ordering Information

PART NUMBER (Notes 1, 2, 3)	TEMP. RANGE (°C)	PACKAGE (Pb-Free)	PKG. DWG. #
ISL29012IROZ-T7 (Note 4)	-40 to +85	6 Ld ODFN	L6.2x2.1
ISL29012IROZ-EVALZ	Evaluation Board		

NOTES:

1. Please refer to [TB347](#) for details on reel specifications.
2. These Intersil Pb-free plastic packaged products employ special Pb-free material sets; molding compounds/die attach materials and 100% matte tin plate - e3 termination finish, which is RoHS compliant and compatible with both SnPb and Pb-free soldering operations. Intersil Pb-free products are MSL classified at Pb-free peak reflow temperatures that meet or exceed the Pb-free requirements of IPC/JEDEC J STD-020.
3. For Moisture Sensitivity Level (MSL), please see device information page for [ISL29012](#). For more information on MSL please see tech brief [TB477](#).
4. Not recommended for new designs.

### Pinout

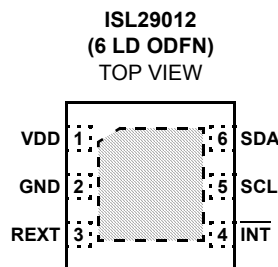

\*EXPOSED PAD CAN BE CONNECTED TO GND OR ELECTRICALLY ISOLATED

### Features

- Range Select Via I<sup>2</sup>C
  - Range 1 = 0.5 lux to 2,000 lux
  - Range 2 = 0.5 lux to 8,000 lux
  - Range 3 = 0.5 lux to 32,000 lux
  - Range 4 = 0.5 lux to 128,000 lux
- Human Eye Response (540nm Peak Sensitivity)
- Temperature Compensated
- Signed 15-bit Resolution
- Adjustable Resolution: Up to 20 Counts per lux
- User-programmable Upper and Lower Threshold Interrupt
- Simple Output Code, Directly Proportional to lux
- IR + UV Rejection
- 50Hz/60Hz Rejection
- 2.5V to 3.3V Supply
- 6 Ld ODFN (2.1mmx2mm)
- Pb-Free (RoHS compliant)
- Operating Temperature Range: -40°C to +85°C
- I<sup>2</sup>C and SMBus Compatible

### Applications

- Display and Keypad Backlight Dimming
  - Mobile Devices: Smart phone, PDA, and GPS
  - Computing Devices: Notebook PC, UMPC Web Pod
  - Consumer Devices: LCD-TV, Digital Picture Frame and Digital Cameras
- Industrial and Medical Light Sensing

### Block Diagram

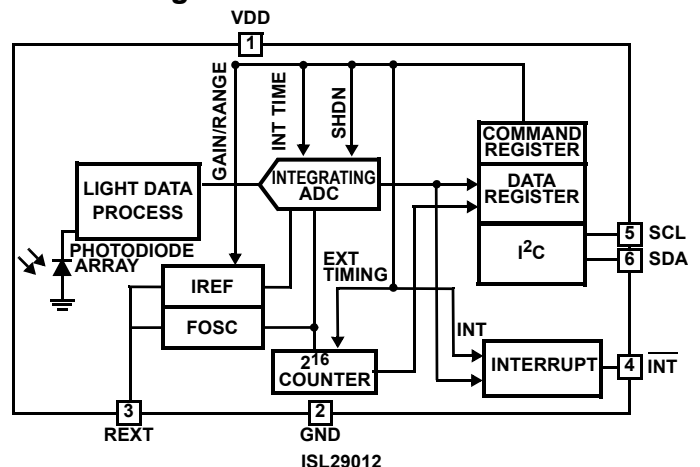

**Absolute Maximum Ratings** ( $T_A = +25^{\circ}\text{C}$ )

$V_{DD}$ Supply Voltage between $V_{DD}$ and GND	3.6V
I <sup>2</sup> C Bus (SCL, SDA) and $\overline{\text{INT}}$ Pin Voltage	-0.2V to 5.5V
I <sup>2</sup> C Bus (SCL, SDA) Pin Current	<10mA
$R_{EXT}$ Pin Voltage	-0.2V to $V_{DD}$
ESD Rating	
Human Body Model	2kV

**Thermal Information**

Thermal Resistance (Typical, Note 5)	$\theta_{JA}$ ( $^{\circ}\text{C}/\text{W}$ )
6 Lead ODFN	88
Maximum Die Temperature	+90 $^{\circ}\text{C}$
Storage Temperature	-40 $^{\circ}\text{C}$ to +100 $^{\circ}\text{C}$
Operating Temperature	-40 $^{\circ}\text{C}$ to +85 $^{\circ}\text{C}$
Pb-free Reflow Profile	see link below
<a href="http://www.intersil.com/pbfree/Pb-FreeReflow.asp">http://www.intersil.com/pbfree/Pb-FreeReflow.asp</a>	

CAUTION: Do not operate at or near the maximum ratings listed for extended periods of time. Exposure to such conditions may adversely impact product reliability and result in failures not covered by warranty.

NOTE:

- $\theta_{JA}$  is measured in free air with the component mounted on a high effective thermal conductivity test board with “direct attach” features. See Tech Brief [TB379](#).

IMPORTANT NOTE: All parameters having Min/Max specifications are guaranteed. Typical values are for information purposes only. Unless otherwise noted, all tests are at the specified temperature and are pulsed tests, therefore:  $T_J = T_C = T_A$

**Electrical Specifications**  $V_{DD} = 3\text{V}$ ,  $T_A = +25^{\circ}\text{C}$ ,  $R_{EXT} = 100\text{k}\Omega$ , unless otherwise specified. Internal Timing Mode operation (See “Principles of Operation” on page 3).

PARAMETER	DESCRIPTION	CONDITION	MIN (Note 8)	TYP	MAX (Note 8)	UNIT
$E_{e-max}$	Maximum Detectable Light Intensity	@ Gain/Range = 4, and $R_{EXT} = 25\text{k}\Omega$		128k		lux
$V_{DD}$	Power Supply Range		2.5		3.30	V
$I_{DD}$	Supply Current			0.25	0.33	mA
$I_{DD1}$	Supply Current Disabled	Software disabled		0.1	1	$\mu\text{A}$
$f_{OSC1}$	Internal Oscillator Frequency	Gain/Range = 1 or 2	308	342	377	kHz
$f_{OSC2}$	Internal Oscillator Frequency	Gain/Range = 3 or 4	616	684	754	kHz
$f_{I2C}$	I <sup>2</sup> C Clock Rate			1 to 400		kHz
DATA0	Dark ADC Code	E = 0 lux, Gain/Range = 1		0	6	Counts
DATA1	Full Scale ADC Code			32767		Counts
DATA2	Light Count Output	E = 300 lux, fluorescent light, Gain/Range = 1 (Note 6)	3300	4400	5500	Counts
DATA3	Light Count Output	E = 300 lux, fluorescent light, Gain/Range = 2 (Note 6)		1100		Counts
DATA4	Light Count Output	E = 300 lux, fluorescent light, Gain/Range = 3 (Note 6)		275		Counts
DATA5	Light Count Output	E = 300 lux, fluorescent light, Gain/Range = 4 (Note 6)		69		Counts
$V_{REF}$	Voltage of $R_{EXT}$ Pin		0.490	0.515	0.540	V
$V_{TL}$	SCL and SDA Threshold LO	(Note 7)		1.05		V
$V_{TH}$	SCL and SDA Threshold HI	(Note 7)		1.95		V
$I_{SDA}$	SDA Current Sinking Capability		3	5		mA
$I_{\overline{\text{INT}}}$	$\overline{\text{INT}}$ Current Sinking Capability		3	5		mA

NOTES:

- Fluorescent light is substituted by a green LED during production.
- The voltage threshold levels of the SDA and SCL pins are  $V_{DD}$  dependent:  $V_{TL} = 0.35 \cdot V_{DD}$ .  $V_{TH} = 0.65 \cdot V_{DD}$ .
- Compliance to datasheet limits is assured by one or more methods: production test, characterization and/or design.

## Pin Descriptions

PIN NUMBER	PIN NAME	DESCRIPTION	
1	VDD	Positive supply; connect this pin to a regulated 2.5V to 3.3V supply.	
2	GND	Ground pin. The thermal pad is connected to the GND pin.	
3	REXT	External resistor pin for ADC reference; connect this pin to ground through a (nominal) 100kΩ resistor with 1% tolerance.	
4	$\overline{\text{INT}}$	Interrupt pin; LO for interrupt/alarming, open drain output.	
5	SCL	I <sup>2</sup> C serial clock	The I <sup>2</sup> C bus lines can be pulled above VDD, 5.5V max.
6	SDA	I <sup>2</sup> C serial data	

## Principles of Operation

### Photodiodes

The ISL29012 contains two photodiode arrays which convert light into current. One diode (D1) is sensitive to both visible and infrared light, while the other one (D2) is only sensitive to infrared light; see Figure 20. Using the infrared portion of the light as a baseline, the visible light can be extracted. The ambient light output is the difference between D1 and D2. The resultant ALS spectral response vs wavelength is shown in Figure 6 in the “Typical Performance Curves” on page 11. After light is converted to current during the light data process, the current output is converted to digital by a single built-in integrating type signed 15-bit Analog-to-Digital Converter (ADC). An I<sup>2</sup>C command reads the visible light intensity in counts.

The converter is a charge-balancing integrating type signed 15-bit ADC. The chosen method for conversion is best for converting small current signals in the presence of an AC periodic noise. A 100ms integration time, for instance, highly rejects 50Hz and 60Hz power line noise simultaneously. See “Integration Time or Conversion Time” on page 7 and “Noise Rejection” on page 8.

The built-in ADC offers user flexibility in integration time or conversion time. There are two timing modes: Internal Timing Mode and External Timing Mode. In Internal Timing Mode, integration time is determined by an internal dual speed oscillator ( $f_{\text{OSC}}$ ), and the n-bit ( $n = 4, 8, 12, 16$ ) counter inside the ADC. In External Timing Mode, integration time is determined by the time between two consecutive I<sup>2</sup>C External Timing Mode commands. See “External Timing Mode” on page 7. A good balancing act of integration time and resolution depending on the application is required for optimal results.

The ADC has four I<sup>2</sup>C programmable range selects to dynamically accommodate various lighting conditions. For very dim conditions, the ADC can be configured at its lowest range. For very bright conditions, the ADC can be configured at its highest range.

### Interrupt Function

The active low interrupt pin is an open drain pull-down configuration. The interrupt pin serves as an alarm or monitoring function to determine whether the ambient light exceeds the upper threshold or goes below the lower threshold. The user can also configure the persistency of the interrupt pin. This helps to avoid false triggers, such as noise or sudden spikes in ambient light conditions. An unexpected camera flash, for example, can be ignored by setting the persistency to 8 integration cycles.

### I<sup>2</sup>C Interface

There are eight (8) 8-bit registers available inside the ISL29012. The command and control registers define the operation of the device. The command and control registers do not change until the registers are overwritten. There are two 8-bit registers that set the high and low interrupt thresholds. There are four 8-bit data Read Only registers. Two bytes for the sensor reading and another two bytes for the timer counts. The data registers contain the ADC's latest digital output, and the number of clock cycles in the previous integration period.

The ISL29012's I<sup>2</sup>C interface slave address is hardwired internally as 1000100. When 1000100x with x as R or  $\overline{W}$  is sent after a START condition, this device compares the first 7 bits of this byte to its address and matches.

Figure 1 shows a sample one-byte read. Figure 2 shows a sample one-byte write. Figure 3 shows a sync\_I<sup>2</sup>C timing diagram sample for externally controlled integration time. The I<sup>2</sup>C bus master always drives the SCL (clock) line, while either the master or the slave can drive the SDA (data) line. Figure 2 shows a sample write. Every I<sup>2</sup>C transaction begins with the master asserting a start condition (SDA falling while SCL remains high). The following byte is driven by the master, and includes the slave address and read/write bit. The receiving device is responsible for pulling SDA low during the acknowledgement period.

Every I<sup>2</sup>C transaction ends with the master asserting a stop condition (SDA rising while SCL remains high).

For more information about the I<sup>2</sup>C standard, please consult the Phillips™ I<sup>2</sup>C specification documents.

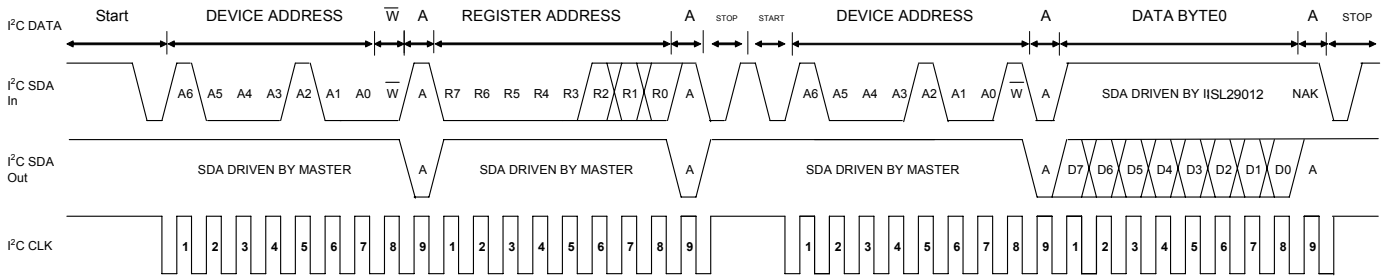

FIGURE 1. I<sup>2</sup>C READ TIMING DIAGRAM SAMPLE

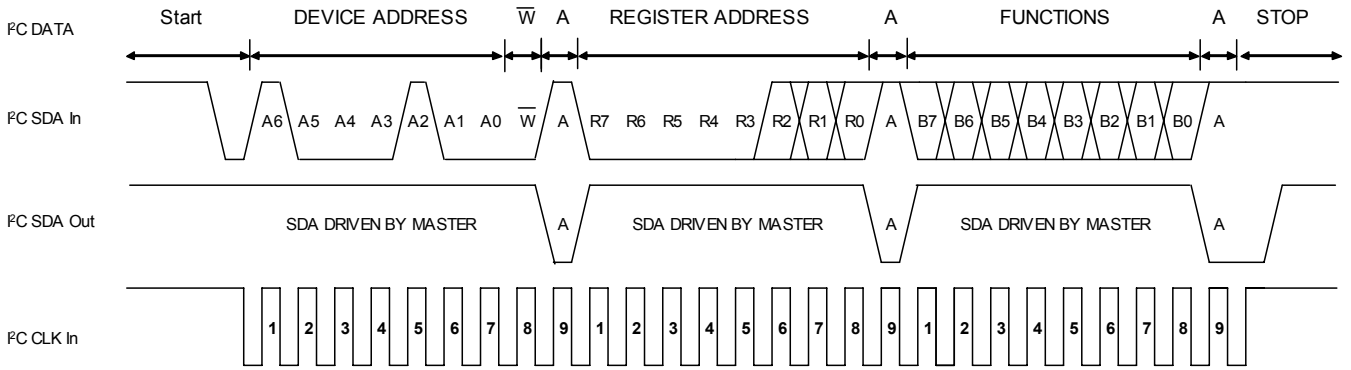

FIGURE 2. I<sup>2</sup>C WRITE TIMING DIAGRAM SAMPLE

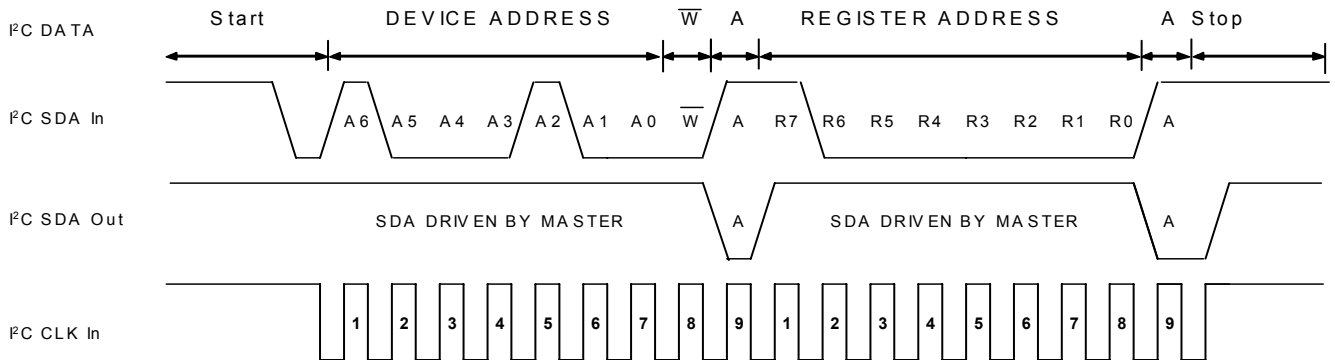

FIGURE 3. I<sup>2</sup>C SYNC\_I<sup>2</sup>C TIMING DIAGRAM SAMPLE

**Register Set**

There are eight registers that are available in the ISL29012. Table 1 summarizes the available registers and their functions.

**TABLE 1. REGISTER SET**

ADDR	REG NAME	BIT								DEFAULT
		7	6	5	4	3	2	1	0	
00h	COMMAND	ADCE	ADCPD	TIMM	0	ADCM1	ADCM0	RES1	RES0	00h
01h	CONTROL	0	0	INT_FLAG	0	GAIN1	GAIN0	IC1	IC0	00h
02h	Interrupt Threshold_HI	ITH_HI7	ITH_HI6	ITH_HI5	ITH_HI4	ITH_HI3	ITH_HI2	ITH_HI1	ITH_HI0	FFh
03h	Interrupt Threshold_LO	ITH_LO7	ITH_LO6	ITH_LO5	ITH_LO4	ITH_LO3	ITH_LO2	ITH_LO1	ITH_LO0	00h
04h	LSB SENSOR	S7	S6	S5	S4	S3	S2	S1	S0	00h
05h	MSB SENSOR	S15	S14	S13	S12	S11	S10	S9	S8	00h
06h	LSB TIMER	T7	T6	T5	T4	T3	T2	T1	T0	00h
07h	MSB TIMER	T15	T14	T13	T12	T11	T10	T9	T8	00h

**TABLE 2. WRITE ONLY REGISTERS**

ADDRESS	REGISTER NAME	FUNCTIONS/ DESCRIPTION
b1xxx_xxxx	sync_I <sup>2</sup> C	Writing a logic 1 to this address bit ends the current ADC-integration and starts another. Used only with External Timing Mode.
bx1xx_xxxx	clar_int	Writing a logic 1 to this address bit clears the interrupt.

**Command Register 00(hex)**

The Read/Write command register has five functions:

1. Enable; Bit 7. This function either resets the ADC or enables the ADC in normal operation. A logic 0 disables ADC to reset-mode. A logic 1 enables ADC to normal operation.

**TABLE 3. ENABLE**

BIT 7	OPERATION
0	Disable ADC-core to reset-mode (default)
1	Enable ADC-core to normal operation

2. ADCPD; Bit 6. This function puts the device in a power-down mode. A logic 0 puts the device in normal operation. A logic 1 powers down the device.

**TABLE 4. ADCPD**

BIT 6	OPERATION
0	Normal operation (default)
1	Power Down

3. Timing Mode; Bit 5. This function determines whether the integration time is done internally or externally. In Internal Timing Mode, integration time is determined by an internal dual speed oscillator ( $f_{OSC}$ ), and the n-bit ( $n = 4, 8, 12, 16$ ) counter inside the ADC. In External Timing Mode, integration time is determined by the time between three consecutive external-sync sync\_I<sup>2</sup>C pulses commands.

**TABLE 5. TIMING MODE**

BIT 5	OPERATION
0	Internal Timing Mode. Integration time is internally timed determined by $f_{OSC}$ , $R_{EXT}$ , and number of clock cycles.
1	External Timing Mode. Integration time is externally timed by the I <sup>2</sup> C host.

4. Photodiode Select Mode; Bits 3 and 2. Setting Bit 3 and Bit 2 to 1 and 0 enables ADC to give light count DATA output.

**TABLE 6. PHOTODIODE SELECT MODE; BITS 2 AND 3**

BITS 3:2	MODE
0:0	Disable ADC
0:1	Disable ADC
1:0	Light count DATA output in signed (n-1) bit *
1:1	No operation.

\*  $n = 4, 8, 12, 16$  depending on the number of clock cycles function.

5. Width; Bits 1 and 0. This function determines the number of clock cycles per conversion. Changing the number of clock cycles does more than just change the resolution of the device. It also changes the integration time, which is the period the device's analog-to-digital (A/D) converter samples the photodiode current signal for a lux measurement.

**TABLE 7. WIDTH**

BITS 1:0	NUMBER OF CLOCK CYCLES
0:0	$2^{16} = 65,536$
0:1	$2^{12} = 4,096$
1:0	$2^8 = 256$
1:1	$2^4 = 16$

**Control Register 01(hex)**

The Read/Write control register has three functions:

1. Interrupt flag; Bit 5. This is the status bit of the interrupt. The bit is set to logic high when the interrupt thresholds have been triggered, and logic low when not yet triggered. Writing a logic low clears/resets the status bit.

**TABLE 8. INTERRUPT FLAG**

BIT 5	OPERATION
0	Interrupt is cleared or not triggered yet
1	Interrupt is triggered

2. Range/Gain; Bits 3 and 2. The Full Scale Range can be adjusted by an external resistor  $R_{EXT}$  and/or it can be adjusted via I<sup>2</sup>C using the Gain/Range function. Gain/Range has four possible values, Range(k) where k is 1 through 4. Table 9 lists the possible values of Range(k) and the resulting FSR for some typical value  $R_{EXT}$  resistors.

**TABLE 9. RANGE/GAIN TYPICAL FSR LUX RANGES**

BITS 3:2	k	RANGE(k)	FSR LUX RANGE@ $R_{EXT} = 50k$	FSR LUX RANGE@ $R_{EXT} = 100k$	FSR LUX RANGE@ $R_{EXT} = 500k$
0:0	1	2,000	2,000	1,000	200
0:1	2	8,000	8,000	4,000	800
1:0	3	32,000	32,000	16,000	3200
1:1	4	128,000	128,000	64,000	12,800

Interrupt persist; Bits 1 and 0. The interrupt pin and the interrupt flag is triggered/set when the data sensor reading is out of the interrupt threshold window after m consecutive number of integration cycles. The interrupt persist bits determine m.

**TABLE 10. INTERRUPT PERSIST**

BITS 1:0	NUMBER OF INTEGRATION CYCLES
0:0	1
0:1	4
1:0	8
1:1	16

**Interrupt Threshold HI Register 02(hex)**

This register sets the HI threshold for the interrupt pin and the interrupt flag. By default the Interrupt threshold HI is FF(hex). The 8-bit data written to the register represents the upper MSB of a 16-bit value. The LSB is always 00(hex).

**Interrupt Threshold LO Register 03(hex)**

This register sets the LO threshold for the interrupt pin and the interrupt flag. By default, the Interrupt threshold LO is 00(hex). The 8-bit data written to the register represents the upper MSB of a 16-bit value. The LSB is always 00(hex).

**Sensor Data Register 04(hex) and 05(hex)**

When the device is configured to output a signed 15-bit data, the most significant byte is accessed at 04(hex), and the least significant byte can be accessed at 05(hex). The sensor data register is refreshed after very integration cycle.

**Timer Data Register 06(hex) and 07(hex)**

Note that the timer counter value is only available when using the External Timing Mode. The 06(hex) and 07(hex) are the LSB and MSB respectively of a 16-bit timer counter value corresponding to the most recent sensor reading. Each clock cycle increments the counter. At the end of each integration period, the value of this counter is made available over the I<sup>2</sup>C. This value can be used to eliminate noise introduced by slight timing errors caused by imprecise external timing. Microcontrollers, for example, often cannot provide high-accuracy command-to-command timing, and the timer counter value can be used to eliminate the resulting noise.

**TABLE 11. DATA REGISTERS**

ADDRESS (hex)	CONTENTS
04	Least-significant byte of most recent sensor reading.
05	Most-significant byte of most recent sensor reading.
06	Least-significant byte of timer counter value corresponding to most recent sensor reading.
07	Most-significant byte of timer counter value corresponding to most recent sensor reading.

**Calculating Lux**

The ISL29012's output codes, DATA, are directly proportional to lux.

$$E = \alpha \times \text{DATA} \quad (\text{EQ. 1})$$

The proportionality constant  $\alpha$  is determined by the Full Scale Range (FSR), and the n-bit ADC which is user defined in the command register. The proportionality constant can also be viewed as the resolution; The smallest lux measurement the device can measure is  $\alpha$ .

$$\alpha = \frac{\text{FSR}}{2^n} \quad (\text{EQ. 2})$$

Full Scale Range (FSR), is determined by the software programmable Range/Gain, Range(k), in the command register and an external scaling resistor  $R_{EXT}$  which is referenced to 100k $\Omega$ .

$$\text{FSR} = \text{Range}(k) \times \frac{100k\Omega}{R_{EXT}} \quad (\text{EQ. 3})$$

The transfer function effectively for each timing mode becomes:

**INTERNAL TIMING MODE**

$$E = \frac{\text{Range}(k) \times \frac{100\text{k}\Omega}{R_{\text{EXT}}}}{2^n} \times \text{DATA} \quad (\text{EQ. 4})$$

**EXTERNAL TIMING MODE**

$$E = \frac{\text{Range}(k) \times \frac{100\text{k}\Omega}{R_{\text{EXT}}}}{\text{COUNTER}} \times \text{DATA} \quad (\text{EQ. 5})$$

n = 3, 7, 11, or 15. This is the number of clock cycles programmed in the command register.

Range(k) is the user defined range in the Gain/Range bit in the command register.

R<sub>EXT</sub> is an external scaling resistor hardwired to the R<sub>EXT</sub> pin.

DATA is the output sensor reading in number of counts available at the data register.

2<sup>n</sup> represents the maximum number of counts possible in Internal Timing Mode. For the External Timing Mode the maximum number of counts is stored in the data register named COUNTER.

COUNTER is the number increments accrued for between integration time for External Timing Mode.

**Gain/Range, Range(k)**

The Gain/Range can be programmed in the control register to give Range(k) determining the FSR. Note that Range(k) is not the FSR (see Equation 3). Range(k) provides four constants depending on programmed k that will be scaled by R<sub>EXT</sub> (see Table 9). Unlike R<sub>EXT</sub>, Range(k) dynamically adjusts the FSR. This function is especially useful when light conditions are varying drastically while maintaining excellent resolution.

**Number of Clock Cycles, n-bit ADC**

The number of clock cycles determines “n” in the n-bit ADC; 2<sup>n</sup> clock cycles is a n-bit ADC. n is programmable in the command register in the width function. Depending on the application, a good balance of speed, and resolution has to be considered when deciding for n. For fast and quick measurement, choose the smallest n = 3. For maximum resolution without regard of time, choose n = 15. Table 12 compares the trade-off between integration time and resolution. See Equations 10 and 11 for the relation between integration time and n. See Equation 3 for the relation of n and resolution.

**TABLE 12. RESOLUTION AND INTEGRATION TIME SELECTION**

n	RANGE1 f <sub>OSC</sub> = 327kHz		RANGE4 f <sub>OSC</sub> = 655kHz	
	t <sub>INT</sub> (ms)	RESOLUTION LUX/COUNT	t <sub>INT</sub> (ms)	RESOLUTION (LUX/COUNT)
15	200	0.06	100	2
11	12.8	1.0	6.4	62.5
7	0.8	15.6	0.4	1,000
3	0.05	250	0.025	16,000

R<sub>EXT</sub> = 100kΩ

**External Scaling Resistor R<sub>EXT</sub> and f<sub>OSC</sub>**

The ISL29012 uses an external resistor R<sub>EXT</sub> to fix its internal oscillator frequency, f<sub>OSC</sub>. Consequently, R<sub>EXT</sub> determines the f<sub>OSC</sub>, integration time and the FSR of the device. f<sub>OSC</sub>, a dual speed mode oscillator, is inversely proportional to R<sub>EXT</sub>. For user simplicity, the proportionality constant is referenced to fixed constants 100kΩ and 655kHz in Equations 6 and 7:

$$f_{\text{OSC}1} = \frac{1}{2} \times \frac{100\text{k}\Omega}{R_{\text{EXT}}} \times 684\text{kHz} \quad (\text{EQ. 6})$$

$$f_{\text{OSC}2} = \frac{100\text{k}\Omega}{R_{\text{EXT}}} \times 684\text{kHz} \quad (\text{EQ. 7})$$

f<sub>OSC1</sub> is oscillator frequency when Range1 or Range2 are set. This is nominally 342kHz when R<sub>EXT</sub> is 100kΩ.

f<sub>OSC2</sub> is the oscillator frequency when Range3 or Range4 are set. This is nominally 684kHz when R<sub>EXT</sub> is 100kΩ.

When the Range/Gain bits are set to Range1 or Range2, f<sub>OSC</sub> runs at half speed compared to when Range/Gain bits are set to Range3 and Range4 by using Equation 8:

$$f_{\text{OSC}1} = \frac{1}{2}(f_{\text{OSC}2}) \quad (\text{EQ. 8})$$

The automatic f<sub>OSC</sub> adjustment feature allows significant improvement of signal-to-noise ratio when detecting very low lux signals.

**Integration Time or Conversion Time**

Integration time is the period during which the device’s analog-to-digital ADC converter samples the photodiode current signal for a lux measurement. Integration time, in other words, is the time to complete the conversion of analog photodiode current into a digital signal--number of counts.

Integration time affects the measurement resolution. For better resolution, use a longer integration time. For short and fast conversions, use a shorter integration time.

The ISL29012 offers user flexibility in the integration time to balance resolution, speed and noise rejection. Integration time can be set internally or externally and can be programmed in the command register 00(hex) Bit 5.



### Integration time in Internal Timing Mode

This timing mode is programmed in the command register 00(hex) Bit 5. Most applications will be using this timing mode. When using the Internal Timing Mode,  $f_{OSC}$  and  $n$ -bits resolution determine the integration time.  $t_{INT}$  is a function of the number of clock cycles and  $f_{OSC}$  as shown in Equation 9:

$$t_{INT} = 2^m \times \frac{1}{f_{OSC}} \quad \text{for Internal Timing Mode only} \quad (\text{EQ. 9})$$

$m = 4, 8, 12,$  and  $16$ .  $n$  is the number of bits of resolution.

$2^m$  therefore is the number of clock cycles.  $n$  can be programmed at the command register 00(hex) Bits 1 and 0.

Since  $f_{OSC}$  is dual speed depending on the Gain/Range bit,  $t_{INT}$  is dual time. The integration time as a function of  $R_{EXT}$  is shown in Equation 10:

$$t_{INT1} = 2^m \times \frac{R_{EXT}}{342\text{kHz} \times 100\text{k}\Omega} \quad (\text{EQ. 10})$$

$t_{INT1}$  is the integration time when the device is configured for Internal Timing Mode and Gain/Range is set to Range1 or Range2.

$$t_{INT2} = 2^m \times \frac{R_{EXT}}{684\text{kHz} \times 100\text{k}\Omega} \quad (\text{EQ. 11})$$

$t_{INT2}$  is the integration time when the device is configured for Internal Timing Mode and Gain/Range is set to Range3 or Range4.

**TABLE 13. INTEGRATION TIMES FOR TYPICAL REXT VALUES**

R <sub>EXT</sub> (kΩ)	RANGE1 RANGE2		RANGE3 RANGE4	
	n = 15-BIT	n = 11-BIT	n = 11-BIT	n = 3
50	100	6.4	3.2	0.013
100**	200	13	6.5	0.025
200	400	26	13	0.050
500	1000	64	32	0.125

\*Integration time in milliseconds

\*\*Recommended R<sub>EXT</sub> resistor value

### Integration time in External Timing Mode

This timing mode is programmed in the command register 00(hex) Bit 5. External Timing Mode is recommended when integration time can be synchronized to an external signal such as a PWM to eliminate noise.

To read the light count DATA output, the device needs three sync\_I<sup>2</sup>C commands to complete one measurement. The 1st sync\_I<sup>2</sup>C command starts the conversion of the diode array 1. The 2nd sync\_I<sup>2</sup>C completes the conversion of diode array 1 and starts the conversion of diode array 2. The 3rd sync\_I<sup>2</sup>C pulses ends the conversion of diode array 2, outputs the light

count DATA, and starts over again to commence conversion of diode array 1.

The integration time,  $t_{INT}$ , is the sum of two identical time intervals between the three sync pulses.  $t_{INT}$  is determined by Equation 12:

$$t_{INT} = \frac{K_{OSC}}{f_{OSC}} \quad (\text{EQ. 12})$$

where  $K_{OSC}$  is the number of internal clock cycles obtained from Timer data register and  $f_{OSC}$  is the internal I<sup>2</sup>C operating frequency

The internal oscillator,  $f_{OSC}$ , operates identically in both the internal and external timing modes, with the same dependence on  $R_{EXT}$ . However, in External Timing Mode, the number of clock cycles per integration is no longer fixed at  $2^n$ . The number of clock cycles varies with the chosen integration time, and is limited to  $2^{16} = 65,536$ . In order to avoid erroneous lux readings, the integration time must be short enough not to allow an overflow in the counter register.

$$t_{INT} < \frac{65,536}{f_{OSC}} \quad (\text{EQ. 13})$$

$f_{OSC} = 342\text{kHz} \times 100\text{k}\Omega / R_{EXT}$ . When Range/Gain is set to Range1 or Range2.

$f_{OSC} = 684\text{kHz} \times 100\text{k}\Omega / R_{EXT}$ . When Range/Gain is set to Range3 or Range4.

### Noise Rejection

In general, integrating type ADC's have excellent noise-rejection characteristics for periodic noise sources whose frequency is an integer multiple of the integration time. For instance, a 60Hz AC unwanted signal's sum from 0ms to  $k \times 16.66\text{ms}$  ( $k = 1, 2, \dots, k_i$ ) is zero. Similarly, setting the device's integration time to be an integer multiple of the periodic noise signal, greatly improves the light sensor output signal in the presence of noise.

### Ambient Light Sensing Operation

The operation of ambient light sensing (ALS) within the ISL29012 utilizes two diodes; D1 and D2. The D1 diode is sensitive to both visible and IR light spectrum. The D2 diode is sensitive to IR spectrum. D1 and D2 spectrum response is shown in Figure 20. The diodes are measured sequentially and their outputs are converted with an ADC. The output of the ALS is the difference between these two measurements.

### Maximum Ambient Intensity Condition

In typical applications, the ISL29012 is installed behind a dark cover window. In this low-light condition, both D1 and D2 operate linearly and the ALS output is linear as well (Figures 18 and 19). In brighter environments and with transparent glass, however, D1 and D2 can be subject to saturation. As the ambient light grows bright enough to subject one or both diodes to saturation, the ALS count (output) decreases and eventually reaches zero in deep

saturation (Figure 17). When using the ISL29012 in high lux applications, one can reduce the  $R_{EXT}$  value and select Range4, the lowest gain to avoid saturation. For example,  $R_{EXT} = 25k\Omega$  is recommended with ambient light near 100,000 lux. If you are operating the ISL29012 at a lower range/higher gain and detect a zero output, the firmware should change the range and recheck the ALS count. One of two situations will be identified. If the output is non-zero, the ISL29012 is saturated. If the output remains zero, the ISL29012 is in a totally dark environment.

**ALS Range For Various Light Sources**

Figure 8 shows spectrum response of various light sources. Fluorescent has little IR content while sunlight, halogen and incandescent light have large IR content. Since both the internal photo diodes D1 and D2 are sensitive to IR spectrum, they saturate at a higher level for the fluorescent light source in comparison to the other 3 light sources. This effect is shown in Figure 21.

**Unstable Ambient Light Condition**

The ISL29012 sequentially measures the difference in the output of two diodes. That's suitable since most changes in ambient light are gradual and any difference between the ambient light conditions for D1 and D2 are negligible. However, it is possible to cause an abrupt change in brightness with a fast-moving hand over the sensor or passing a tree shadow in a fast moving car. To handle these anomalies, we suggest comparing several sequential readings and discarding any data with sudden changes.

**Flat Window Lens Design**

A window lens will surely limit the viewing angle of the ISL29012. The window lens should be placed directly on top of the device. The thickness of the lens should be kept at minimum to minimize loss of power due to reflection and also to minimize loss of loss due to absorption of energy in the plastic material. A thickness of  $t = 1mm$  is recommended for a window lens design. The bigger the diameter of the window lens the wider the viewing angle is of the ISL29012. Table 14 shows the recommended dimensions of the optical window to ensure both 35° and 45° viewing angle. These dimensions are based on a window lens thickness of 1.0mm and a refractive index of 1.59.

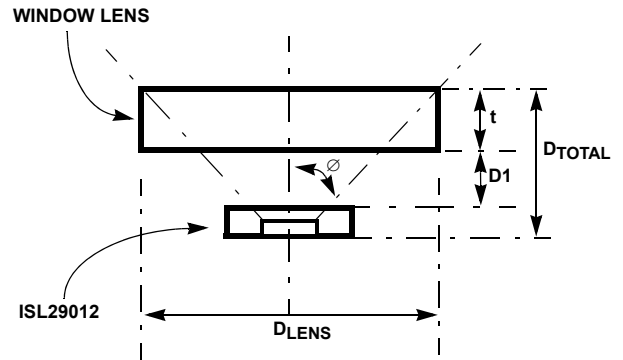

$$E = \frac{DATA}{2^{15}} \times 2000 \quad \phi = \text{VIEWING ANGLE}$$

FIGURE 4. FLAT WINDOW LENS

TABLE 14. RECOMMENDED DIMENSIONS FOR A FLAT WINDOW DESIGN

$D_{TOTAL}$	$D1$	$D_{LENS} @ 35^\circ$ VIEWING ANGLE	$D_{LENS} @ 45^\circ$ VIEWING ANGLE
1.5	0.50	2.25	3.75
2.0	1.00	3.00	4.75
2.5	1.50	3.75	5.75
3.0	2.00	4.30	6.75
3.5	2.50	5.00	7.75

- $t = 1$  Thickness of lens
- $d1$  Distance between ISL29012 and inner edge of lens
- $D_{LENS}$  Diameter of lens
- $d_{TOTAL}$  Distance constraint between the ISL29012 and lens outer edge

\* All dimensions are in mm.

**Suggested PCB Footprint**

It is important that the users check the “Surface Mount Assembly Guidelines for Optical Dual FlatPack No Lead (ODFN) Package” before starting ODFN product board mounting.

<http://www.intersil.com/data/tb/TB477.pdf>

**Layout Considerations**

The ISL29012 is relatively insensitive to layout. Like other I<sup>2</sup>C devices, it is intended to provide excellent performance even in significantly noisy environments. There are only a few considerations that will ensure best performance.

Route the supply and I<sup>2</sup>C traces as far as possible from all sources of noise. Use one 0.01µF power-supply decoupling capacitor, placed close to the device.

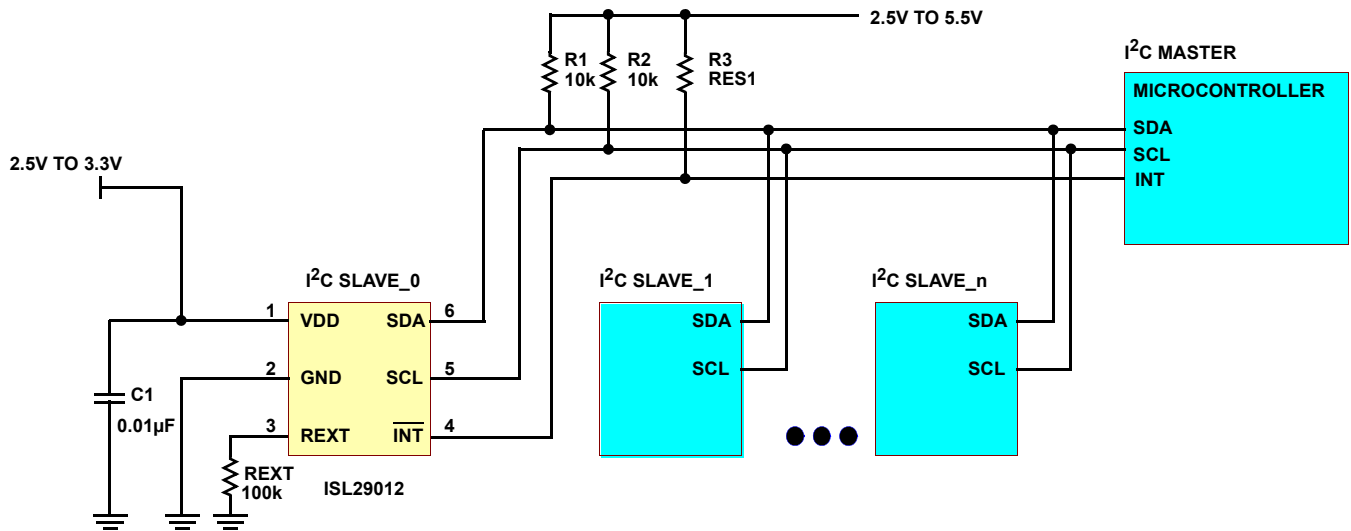

FIGURE 5. ISL29012 TYPICAL CIRCUIT

### Typical Circuit

A typical application for the ISL29012 is shown in Figure 5. The ISL29012's I<sup>2</sup>C address is internally hardwired as 1000100. The device can be tied onto a system's I<sup>2</sup>C bus together with other I<sup>2</sup>C compliant devices.

### Soldering Considerations

Convection heating is recommended for reflow soldering; direct-infrared heating is not recommended. The plastic ODFN package does not require a custom reflow soldering profile, and is qualified to +260°C. A standard reflow soldering profile with a +260°C maximum is recommended.

Typical Performance Curves ( $R_{EXT} = 100k\Omega$ )

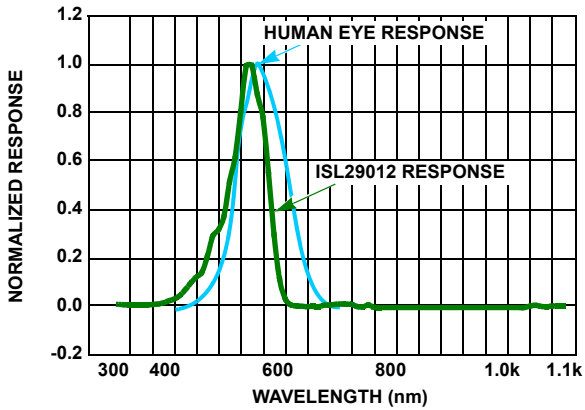

FIGURE 6. SPECTRAL RESPONSE

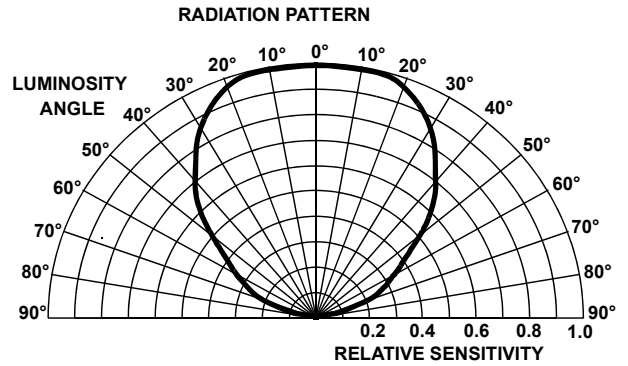

FIGURE 7. RADIATION PATTERN

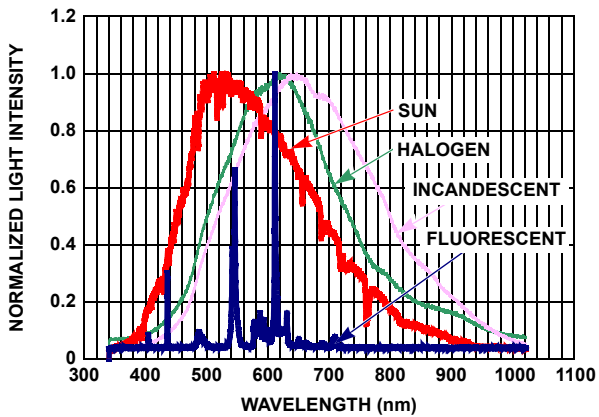

FIGURE 8. SPECTRUM OF LIGHT SOURCES FOR MEASUREMENT

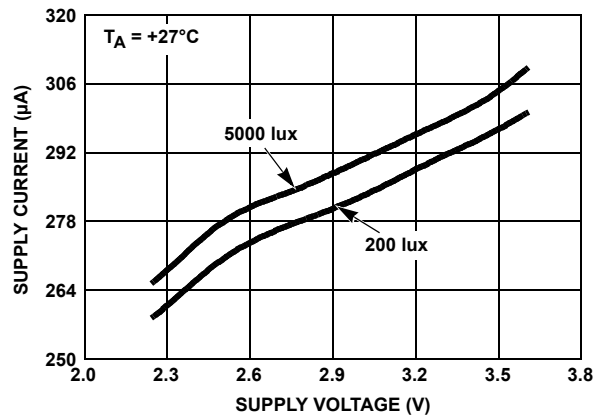

FIGURE 9. SUPPLY CURRENT vs SUPPLY VOLTAGE

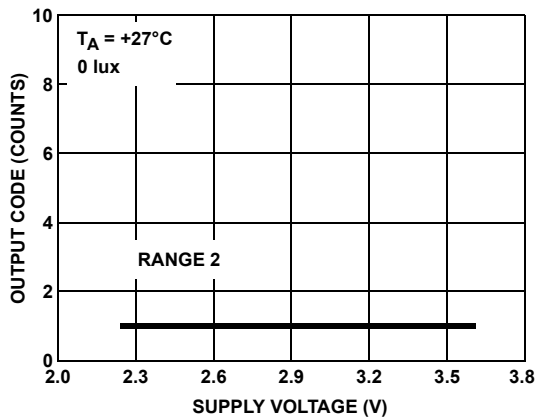

FIGURE 10. OUTPUT CODE FOR 0 LUX vs SUPPLY VOLTAGE

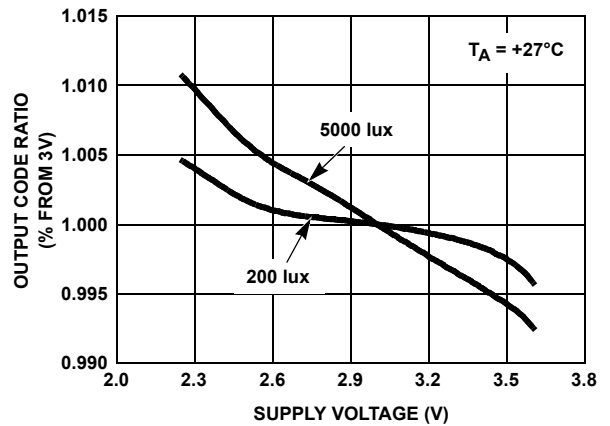

FIGURE 11. OUTPUT CODE vs SUPPLY VOLTAGE

Typical Performance Curves ( $R_{EXT} = 100k\Omega$ ) (Continued)

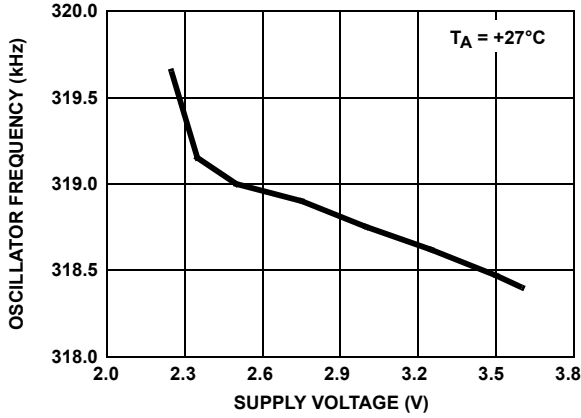

FIGURE 12. OSCILLATOR FREQUENCY vs SUPPLY VOLTAGE

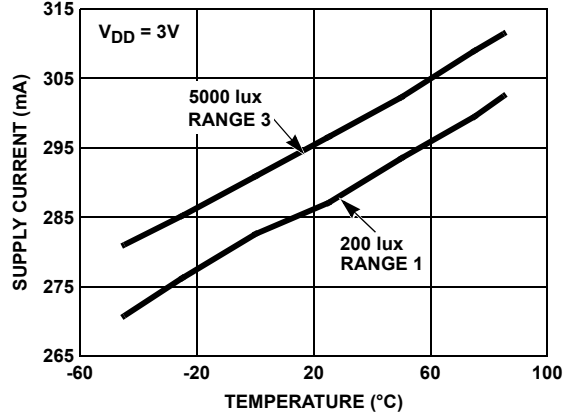

FIGURE 13. SUPPLY CURRENT vs TEMPERATURE

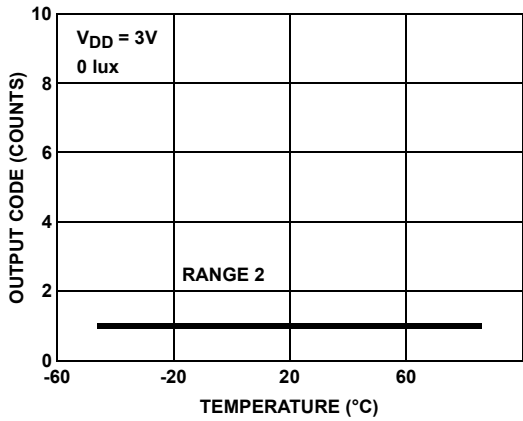

FIGURE 14. OUTPUT CODE FOR 0 LUX vs TEMPERATURE

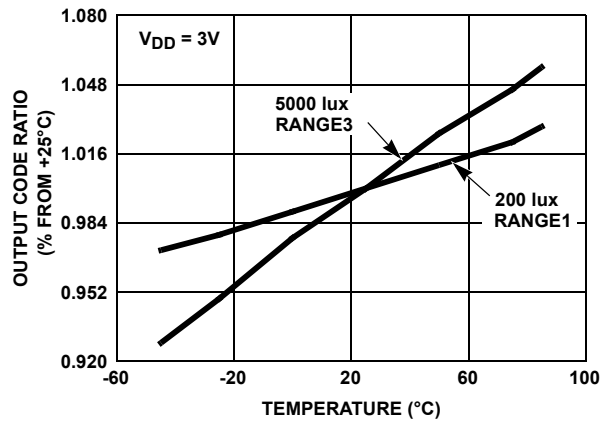

FIGURE 15. OUTPUT CODE vs TEMPERATURE

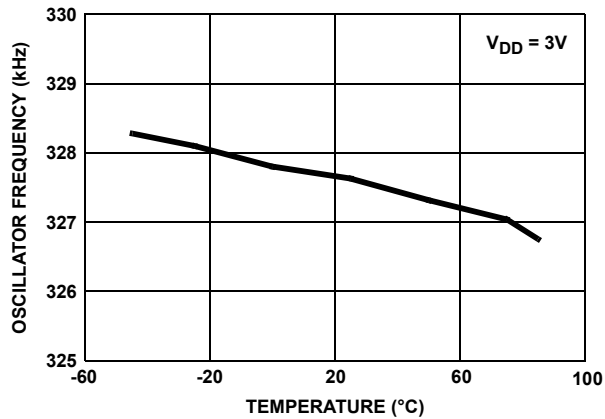

FIGURE 16. OSCILLATOR FREQUENCY vs TEMPERATURE

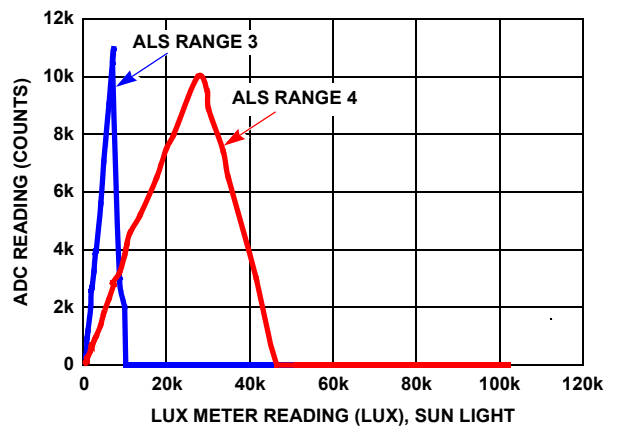

FIGURE 17. SATURATION CHARACTERISTICS

Typical Performance Curves ( $R_{EXT} = 100k\Omega$ ) (Continued)

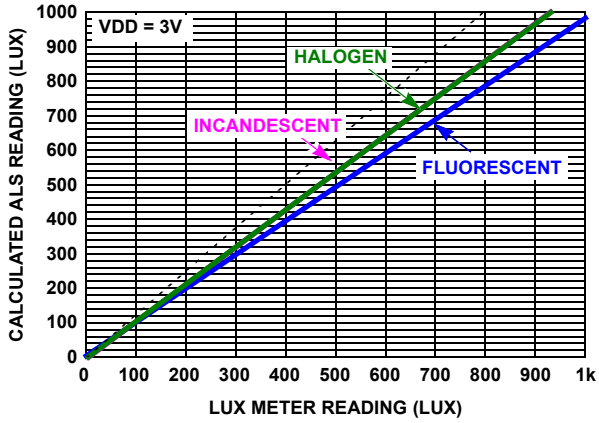

FIGURE 18. LIGHT SENSITIVITY vs LUX LEVEL

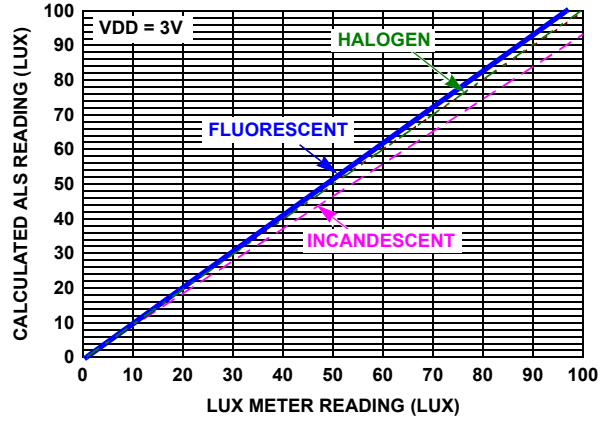

FIGURE 19. LIGHT SENSITIVITY vs LUX LEVEL

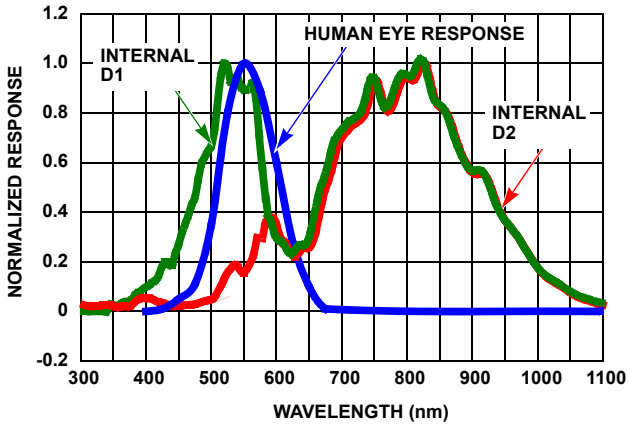

FIGURE 20. SPECTRAL RESPONSE INTERNAL DIODES

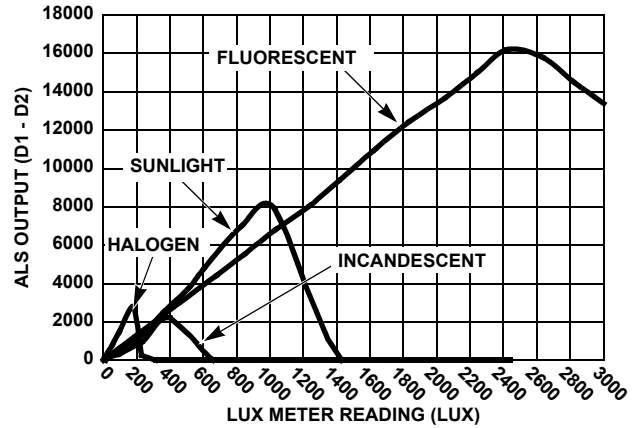

FIGURE 21. ALS OUTPUT vs LUX LEVEL @ RANGE = 1,  $R_{EXT} = 50k\Omega$

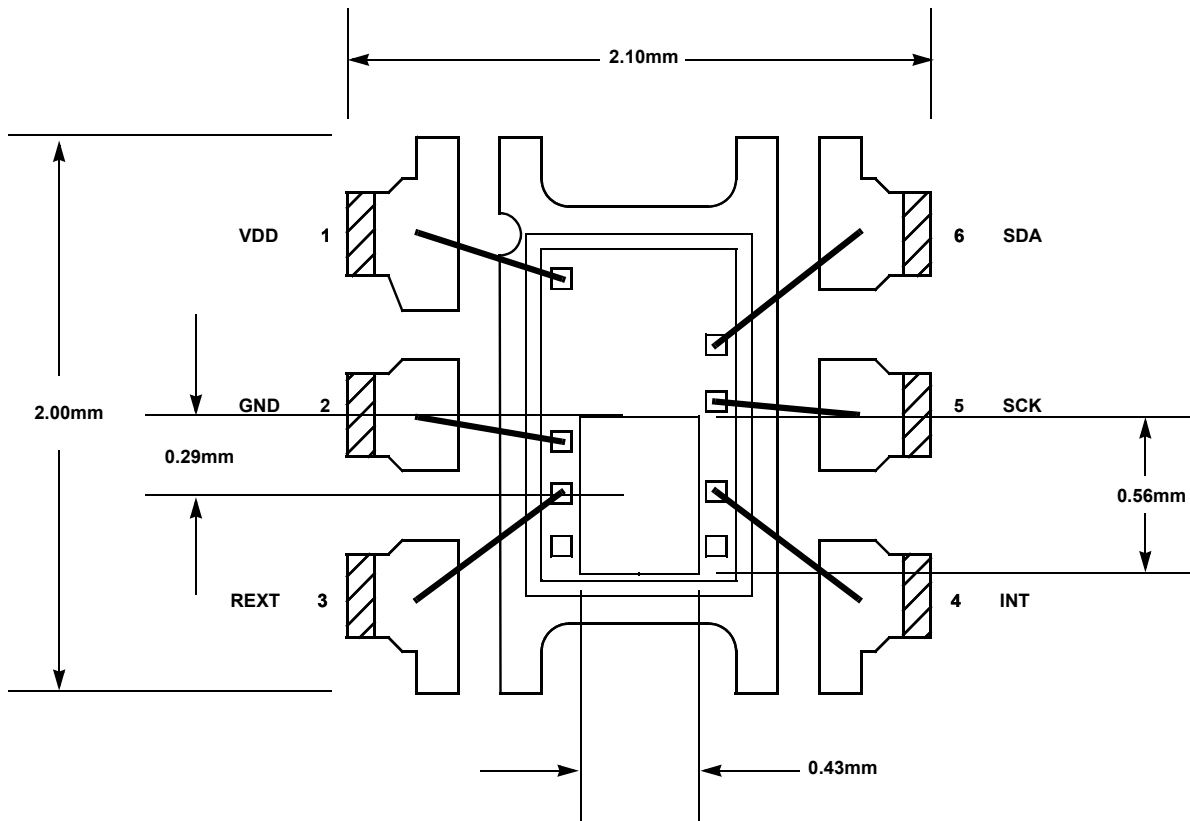

FIGURE 22. 6 LD ODFN SENSOR LOCATION OUTLINE

All Intersil U.S. products are manufactured, assembled and tested utilizing ISO9000 quality systems. Intersil Corporation's quality certifications can be viewed at [www.intersil.com/design/quality](http://www.intersil.com/design/quality)

*Intersil products are sold by description only. Intersil Corporation reserves the right to make changes in circuit design, software and/or specifications at any time without notice. Accordingly, the reader is cautioned to verify that data sheets are current before placing orders. Information furnished by Intersil is believed to be accurate and reliable. However, no responsibility is assumed by Intersil or its subsidiaries for its use; nor for any infringements of patents or other rights of third parties which may result from its use. No license is granted by implication or otherwise under any patent or patent rights of Intersil or its subsidiaries.*

For information regarding Intersil Corporation and its products, see [www.intersil.com](http://www.intersil.com)

# Package Outline Drawing

## L6.2x2.1

6 LEAD OPTICAL DUAL FLAT NO-LEAD PLASTIC PACKAGE (ODFN)

Rev 3, 5/11

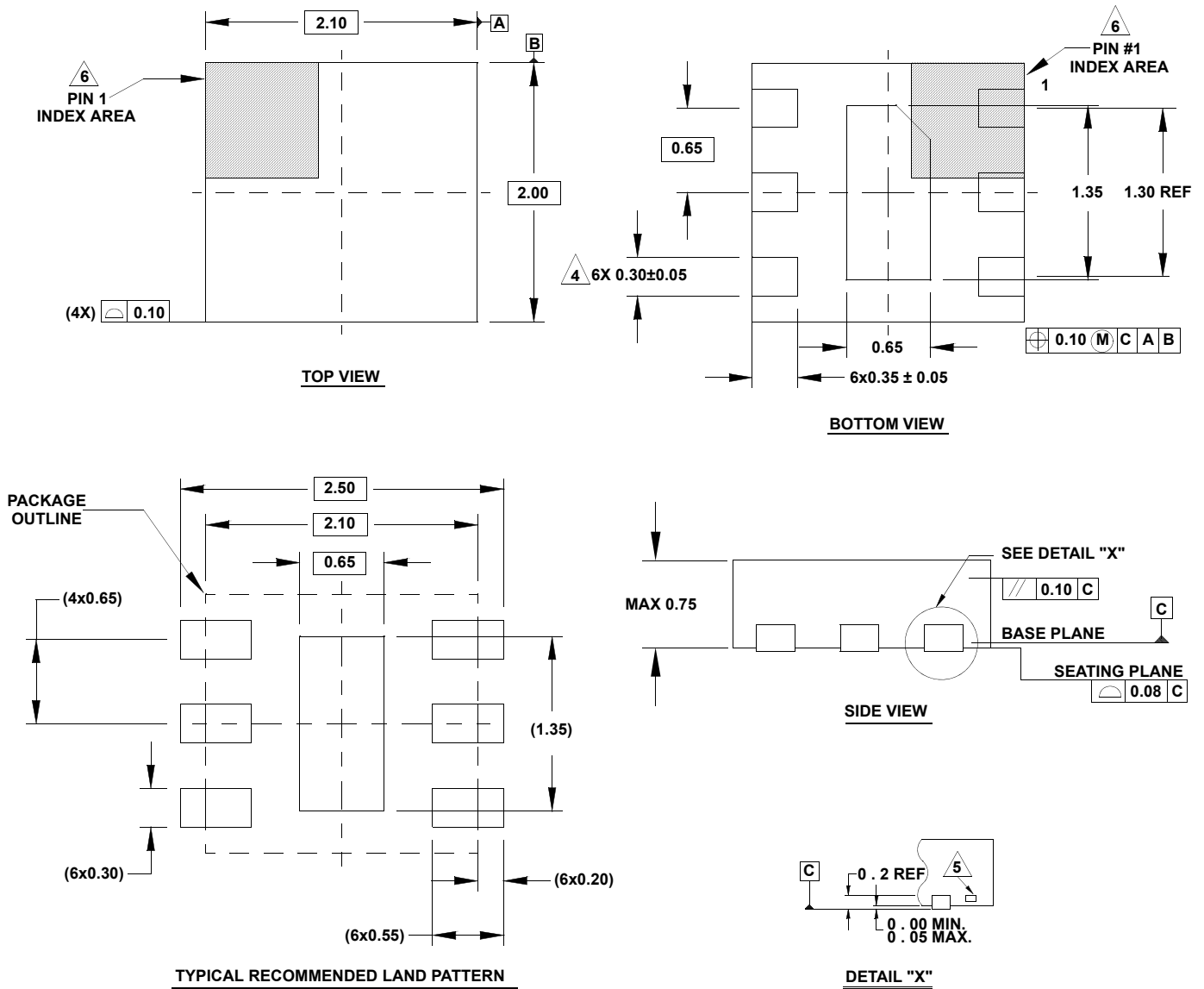

### NOTES:

- Dimensions are in millimeters.  
Dimensions in ( ) for Reference Only.
- Dimensioning and tolerancing conform to ASME Y14.5m-1994.
- Unless otherwise specified, tolerance : Decimal ± 0.05
- Dimension applies to the metallized terminal and is measured between 0.15mm and 0.30mm from the terminal tip.
- Tiebar shown (if present) is a non-functional feature.
- The configuration of the pin #1 identifier is optional, but must be located within the zone indicated. The pin #1 identifier may be either a mold or mark feature.