



Chipsmall Limited consists of a professional team with an average of over 10 year of expertise in the distribution of electronic components. Based in Hongkong, we have already established firm and mutual-benefit business relationships with customers from,Europe,America and south Asia,supplying obsolete and hard-to-find components to meet their specific needs.

With the principle of “Quality Parts,Customers Priority,Honest Operation,and Considerate Service”,our business mainly focus on the distribution of electronic components. Line cards we deal with include Microchip,ALPS,ROHM,Xilinx,Pulse,ON,Everlight and Freescale. Main products comprise IC,Modules,Potentiometer,IC Socket,Relay,Connector.Our parts cover such applications as commercial,industrial, and automotives areas.

We are looking forward to setting up business relationship with you and hope to provide you with the best service and solution. Let us make a better world for our industry!



Contact us

Tel: +86-755-8981 8866 Fax: +86-755-8427 6832

Email & Skype: info@chipsmall.com Web: www.chipsmall.com

Address: A1208, Overseas Decoration Building, #122 Zhenhua RD., Futian, Shenzhen, China



Triple Channel Video Driver with LPF

The ISL59123 is a triple channel reconstruction filter with a -3dB roll-off frequency of 18MHz. Operating from single supplies ranging from +2.5V to +3.6V and sinking a low 4mA quiescent current, the ISL59123 is ideally suited for low power, battery-operated applications. An enable pin allows the part to be placed in a 500nA shutdown mode in less than 30ns.

The ISL59123 is designed to meet the needs for extremely low power and bandwidth requirements in battery-operated communication, instrumentation, and modern industrial applications such as video on demand, cable set-top boxes, MP3 players, and HDTV. The ISL59123 is offered in a space-saving chipscale package guaranteed to a 0.57mm maximum height constraint and specified for operation from -40°C to +85°C temperature range.

Block Diagram

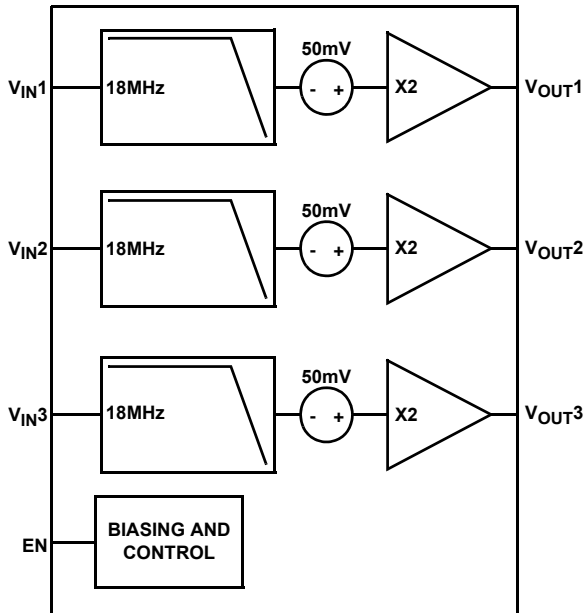

Features

- 3rd order 18MHz reconstruction filter
- 4mA typical supply current
- Less than 500nA maximum power-down current
- 2.5V to 3.6V supply range
- CSP package
- Pb-free plus anneal available (RoHS compliant)

Applications

- Video amplifiers
- Portable and handheld products
- Communications devices
- Video on demand
- Cable set-top boxes
- Satellite set-top boxes
- MP3 players
- HDTV
- Personal video recorder

Pinout

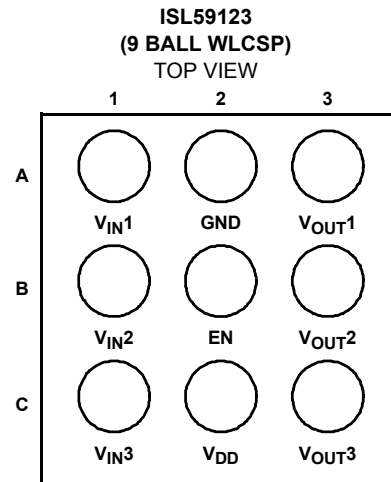

Ordering Information

PART NUMBER (Note)	PART MARKING	TAPE AND REEL	TEMP. RANGE (°C)	PACKAGE (Pb-free)	PKG. DWG. #
ISL59123IIZ-T7	123Z	7"	-40 to +85	9 Ball 3x3 WLCSP	W3x3.9B

NOTE: Intersil Pb-free plus anneal products employ special Pb-free material sets; molding compounds/die attach materials and 100% matte tin plate termination finish, which are RoHS compliant and compatible with both SnPb and Pb-free soldering operations. Intersil Pb-free products are MSL classified at Pb-free peak reflow temperatures that meet or exceed the Pb-free requirements of IPC/JEDEC J STD-020.

Absolute Maximum Ratings ($T_A = +25^\circ\text{C}$)

Supply Voltage from V_{DD} to GND	4.2V
Input Voltage	$V_{DD} + 0.3\text{V}$ to GND -0.3V
Continuous Output Current	40mA
Storage Temperature	-65°C to $+125^\circ\text{C}$
Ambient Operating Temperature	-40°C to $+85^\circ\text{C}$
Operating Junction Temperature	$+125^\circ\text{C}$
ESD Rating	
Human Body Model (Per MIL-STD-883 Method 3015.7)	2500V
Machine Model (Per EIAJ ED-4701 Method C-111)	300V

Thermal Information

Thermal Resistance (Typical)	θ_{JA} ($^\circ\text{C}/\text{W}$)
9 Ball WLCSP	105
Pb-free reflow profile	see link below
http://www.intersil.com/pbfree/Pb-FreeReflow.asp	

CAUTION: Stresses above those listed in "Absolute Maximum Ratings" may cause permanent damage to the device. This is a stress only rating and operation of the device at these or any other conditions above those indicated in the operational sections of this specification is not implied.

IMPORTANT NOTE: All parameters having Min/Max specifications are guaranteed. Typ values are for information purposes only. Unless otherwise noted, all tests are at the specified temperature and are pulsed tests, therefore: $T_J = T_C = T_A$

Electrical Specifications $V_{DD} = 3.3\text{V}$, $T_A = +25^\circ\text{C}$, $R_{SOURCE} = 200\Omega$, $R_L = 150\Omega$ to GND, unless otherwise specified.

PARAMETER	DESCRIPTION	CONDITIONS	MIN	TYP	MAX	UNIT
INPUT CHARACTERISTICS						
V_{DD}	Supply Voltage Range		2.5		3.6	V
I_{DD}	Quiescent Supply Current	$V_{IN} = 500\text{mV}$, $EN = V_{DD}$, no load		4.0	6.0	mA
I_{DD_OFF}	Shutdown Supply Current	$EN = 0\text{V}$			0.5	μA
C_{IN}	V_{IN} Input Capacitance				10	pF
I_{IN}	V_{IN} Input Bias Current	$0.0\text{V} < V_{IN} < 2.0\text{V}$		0.01	1	μA
V_{OLS}	Output Level Shift Voltage	$V_{IN} = 0\text{V}$, no load (minimum output voltage)	45	100	150	mV
A_V	Voltage Gain	$R_L = 150\Omega$	1.95	1.99	2.04	V/V
ΔA_V	Channel-to Channel Gain Mismatch			± 0.5	± 1.75	%
PSRR	DC Power Supply Rejection	$V_{DD} = 2.7\text{V}$ to 3.3V		63		dB
V_{OH}	Output Voltage High Swing	$V_{IN} = 2\text{V}$, $R_L = 150\Omega$ to GND	2.85	3.1		V
I_{SC}	Output Short-Circuit Current	$V_{IN} = 2\text{V}$, V_{OUT} shorted to GND through 10Ω	100	140		mA
		$V_{IN} = 0\text{V}$, V_{OUT} shorted to V_{DD} through 10Ω	140	200		mA
I_{ENABLE}	Enable Input Current	$0\text{V} < V_{EN} < 3.3\text{V}$		± 0.003	± 1	μA
V_{IL}	Disable Threshold	$V_{DD} = 2.7\text{V}$ to 3.3V			0.8	V
V_{IH}	Enable Threshold	$V_{DD} = 2.7\text{V}$ to 3.3V	2.0			V
R_{OUT}	Shutdown Output Impedance	$EN = 0\text{V}$ DC	5.0	6.4	8.0	k Ω
		$EN = 0\text{V}$, $f = 4.5\text{MHz}$		1.5		k Ω
AC PERFORMANCE						
BW	-3dB Bandwidth	$R_L = 150\Omega$, $C_L = 5\text{pF}$		18		MHz
Passband Gain	Normalized Gain at 11MHz	$R_L = 150\Omega$, $C_L = 5\text{pF}$	-0.5		+0.5	dB
Stopband Gain	Normalized Stopband Gain (minimum limits guaranteed by design and bench characterization)	$f = 43\text{MHz}$	-11	-16		dB
		$f = 54\text{MHz}$	-16	-21		dB
dG	Differential Gain	NTSC and PAL		0.10		%
dP	Differential Phase	NTSC and PAL		0.5		$^\circ$
D/DT	Group Delay Variation	$f = 400\text{kHz}$, 5MHz		5.4		ns
SNR	Signal To Noise Ratio	100% white signal		65		dB
+SR	Positive Slew Rate	10% to 90%, $V_{IN} = 1\text{V}$ step	40	55		V/ μs

Electrical Specifications $V_{DD} = 3.3V$, $T_A = +25^\circ C$, $R_{SOURCE} = 200\Omega$, $R_L = 150\Omega$ to GND, unless otherwise specified. (Continued)

PARAMETER	DESCRIPTION	CONDITIONS	MIN	TYP	MAX	UNIT
-SR	Negative Slew Rate	90% to 10%, $V_{IN} = 1V$ step	50	60		V/ μs
t_F	Fall Time	$2.5V_{STEP}$, 80% to 20%		25		ns
t_R	Rise Time	$2.5V_{STEP}$, 20% to 80%		22		ns
t_{ON}	Enable Time	$V_{IN} = 500mV$, V_{OUT} to 1%		250		ns
t_{OFF}	Disable Time	$V_{IN} = 500mV$, V_{OUT} to 1%		30		ns

Pin Descriptions

PIN NUMBER	PIN NAME	DESCRIPTION
A1	V_{IN1}	Video input for Channel 1
A2	GND	Ground
A3	V_{OUT1}	Video output for Channel 1
B1	V_{IN2}	Video input for Channel 2
B2	EN	Enable
B3	V_{OUT2}	Video output for Channel 2
C1	V_{IN3}	Video input for Channel 3
C2	V_{DD}	Positive power supply
C3	V_{OUT3}	Video output for Channel 3

Component Video Connection Diagram

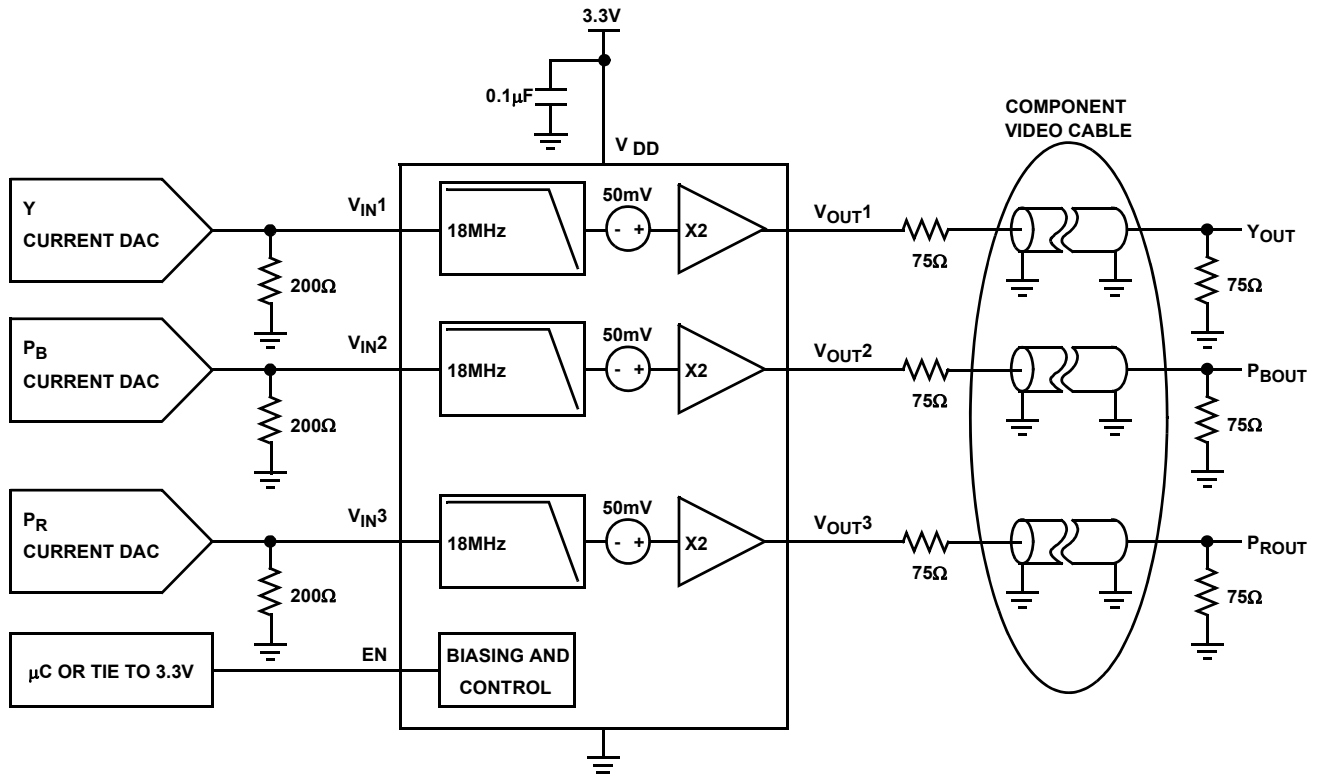

Composite and S-Video Connection Diagram

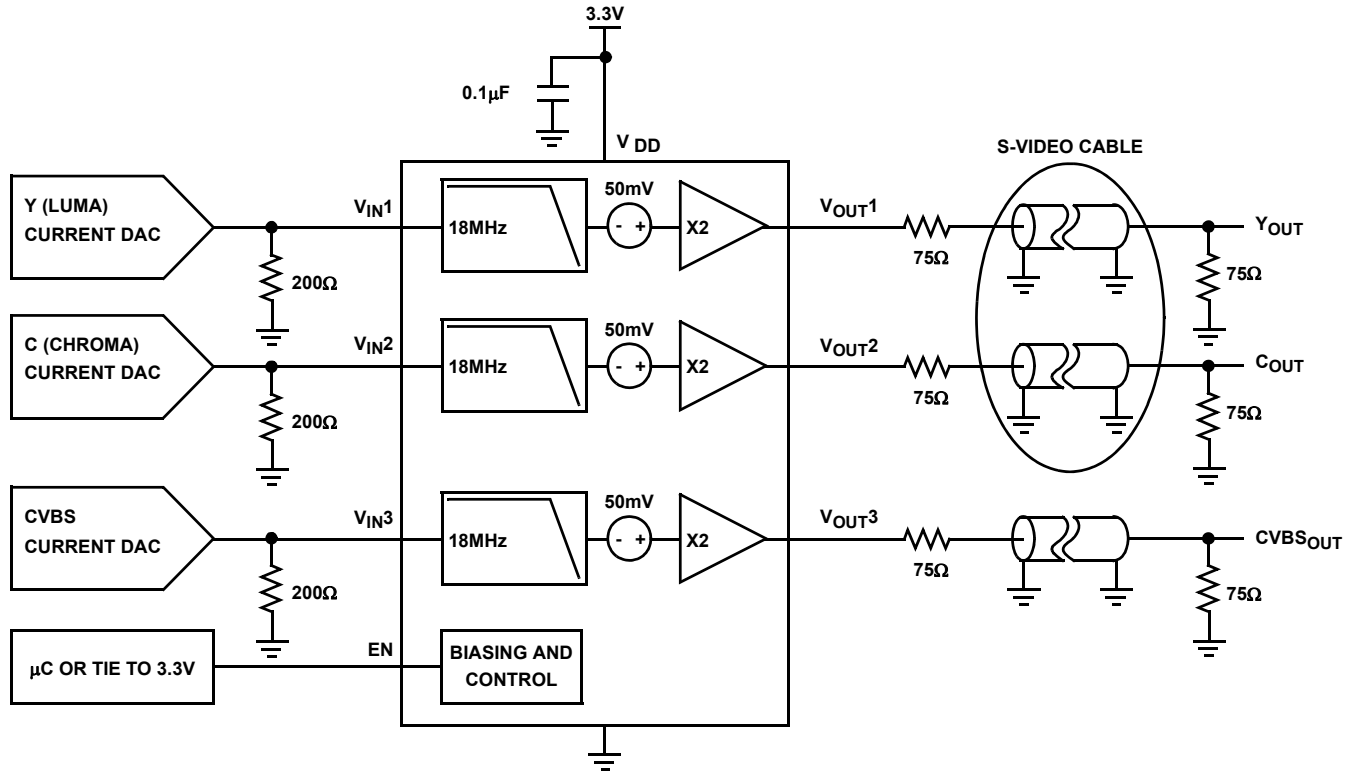

Typical Performance Curves $V_{DD} = +3.3V$, $R_L = 150\Omega$, unless otherwise noted

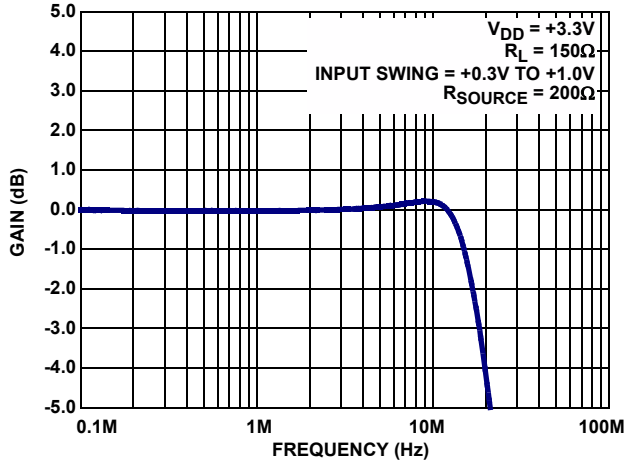

FIGURE 1. GAIN vs FREQUENCY -0.1dB

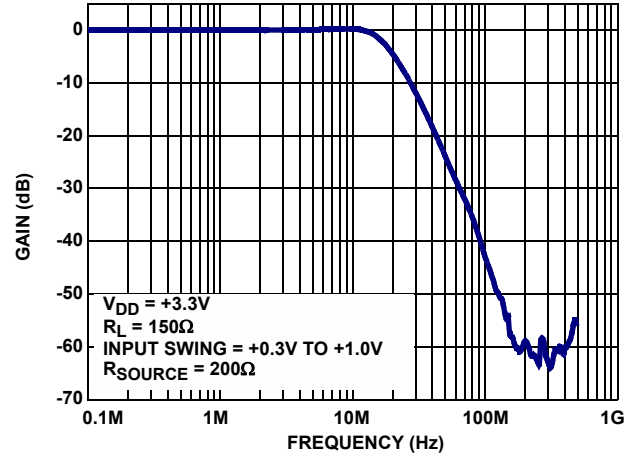

FIGURE 2. GAIN vs FREQUENCY -3dB POINT

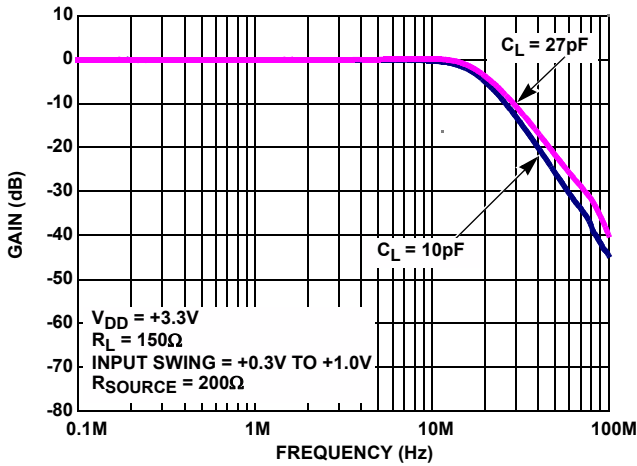

FIGURE 3. GAIN vs FREQUENCY FOR VARIOUS C_{LOAD}

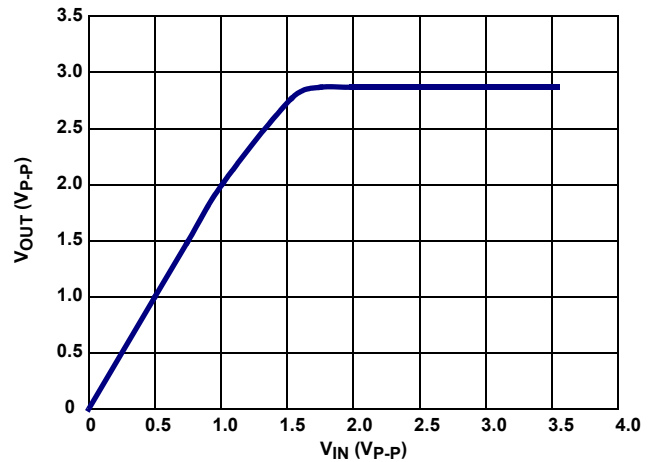

FIGURE 4. MAXIMUM OUTPUT MAGNITUDE vs INPUT MAGNITUDE

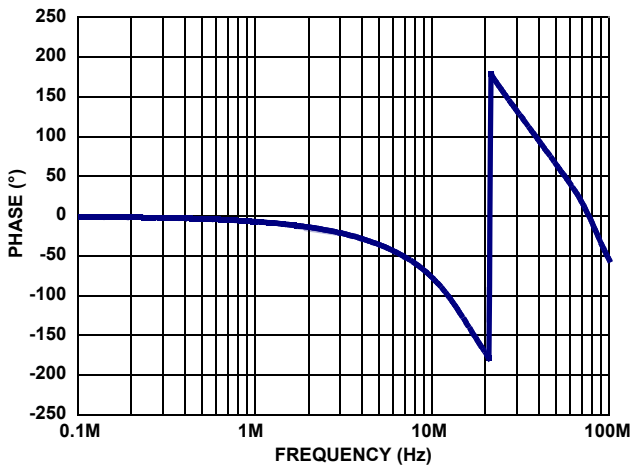

FIGURE 5. PHASE vs FREQUENCY

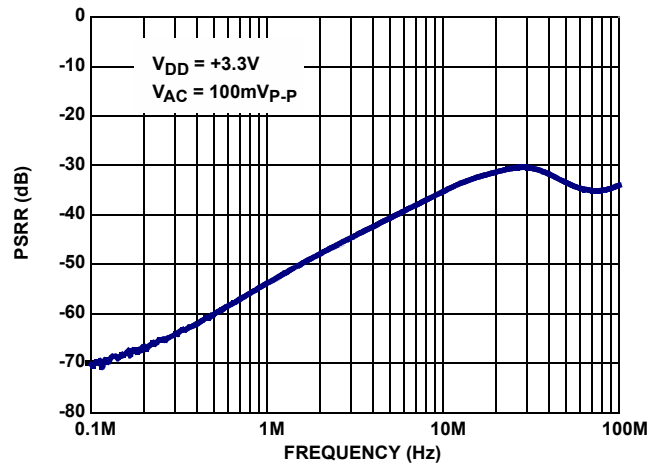

FIGURE 6. PSRR vs FREQUENCY

Typical Performance Curves $V_{DD} = +3.3V$, $R_L = 150\Omega$, unless otherwise noted (Continued)

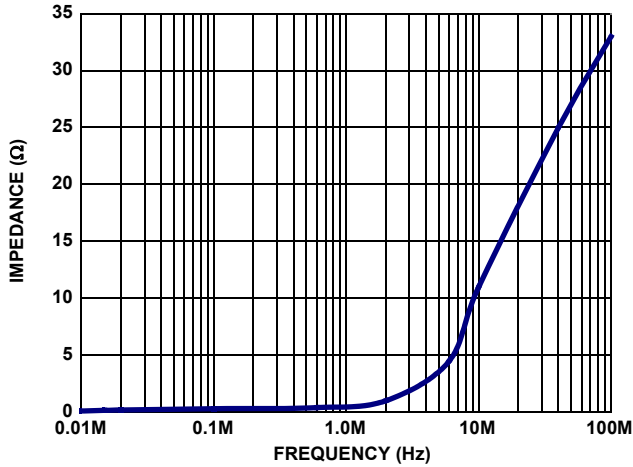

FIGURE 7. OUTPUT IMPEDANCE vs FREQUENCY

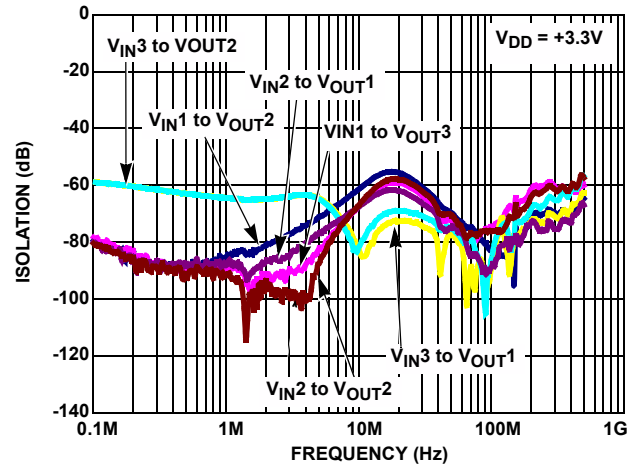

FIGURE 8. ISOLATION vs FREQUENCY

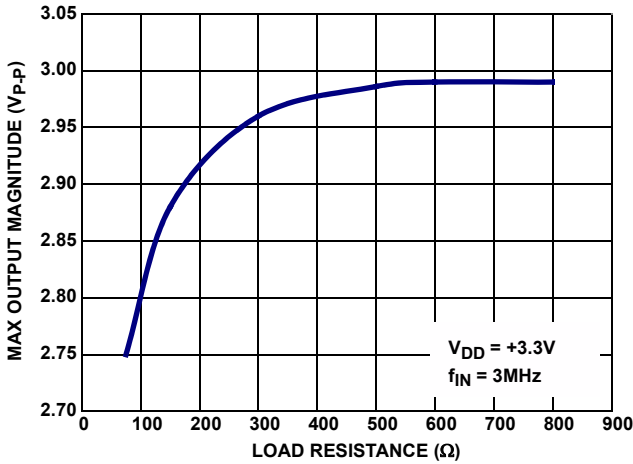

FIGURE 9. MAXIMUM OUTPUT vs LOAD RESISTANCE

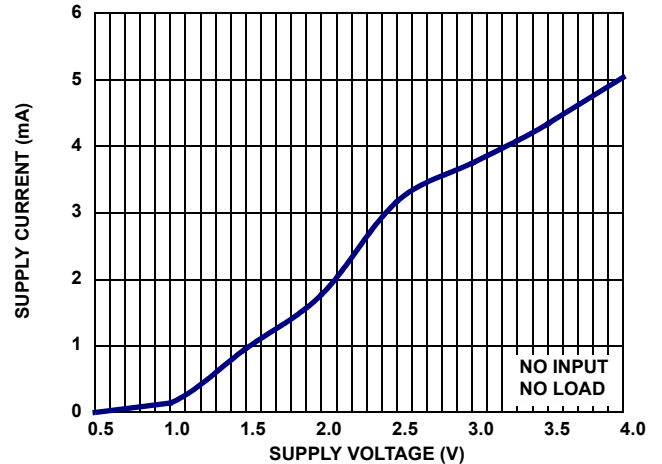

FIGURE 10. SUPPLY CURRENT vs SUPPLY VOLTAGE

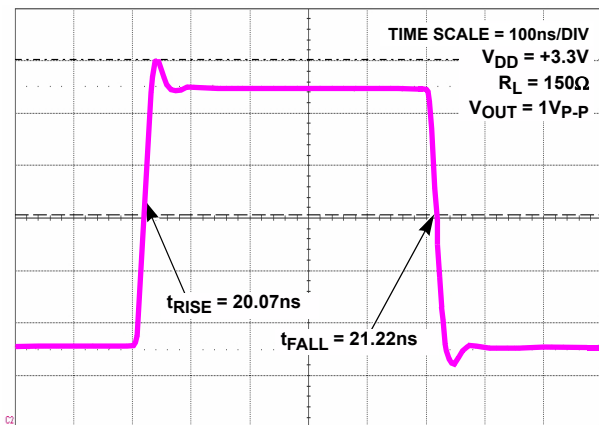

FIGURE 11. LARGE SIGNAL STEP RESPONSE

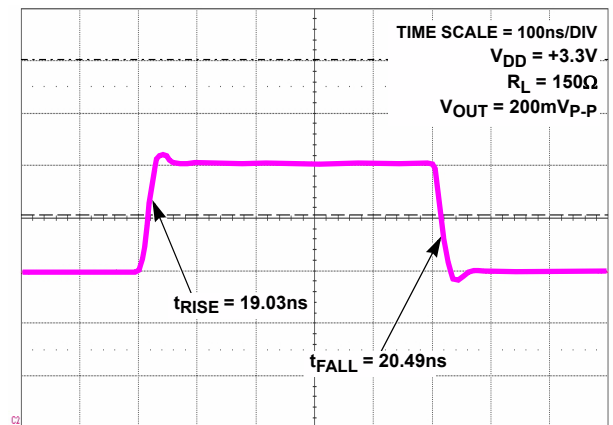

FIGURE 12. SMALL SIGNAL STEP RESPONSE

Typical Performance Curves $V_{DD} = +3.3V$, $R_L = 150\Omega$, unless otherwise noted (Continued)

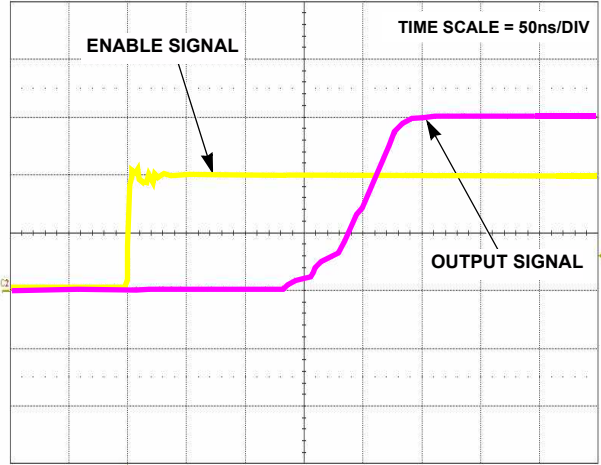

FIGURE 13. ENABLE TIME

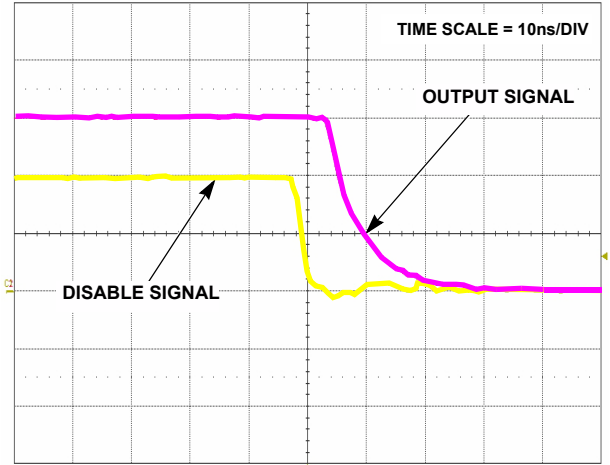

FIGURE 14. DISABLE TIME

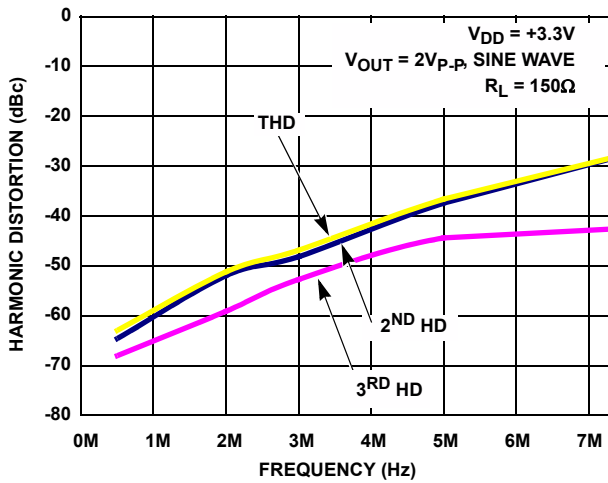

FIGURE 15. HARMONIC DISTORTION vs FREQUENCY

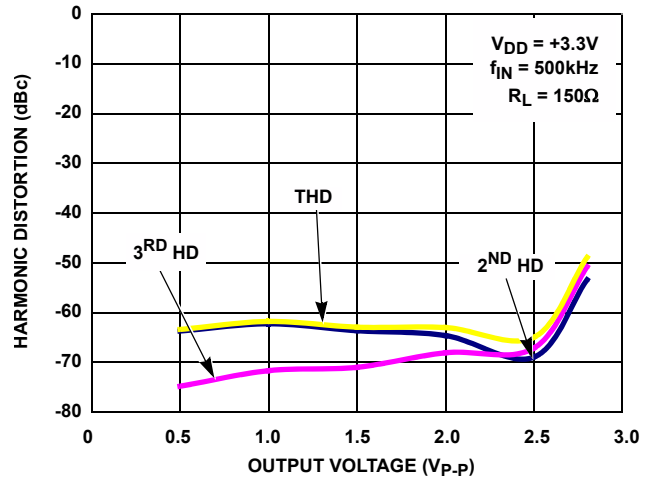

FIGURE 16. HARMONIC DISTORTION vs OUTPUT VOLTAGE

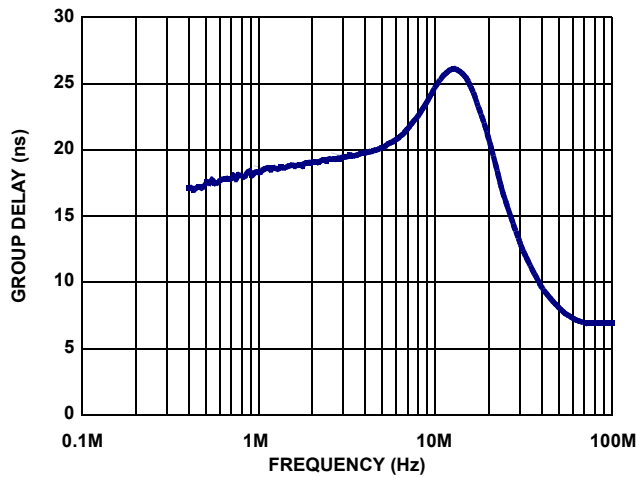

FIGURE 17. GROUP DELAY vs FREQUENCY

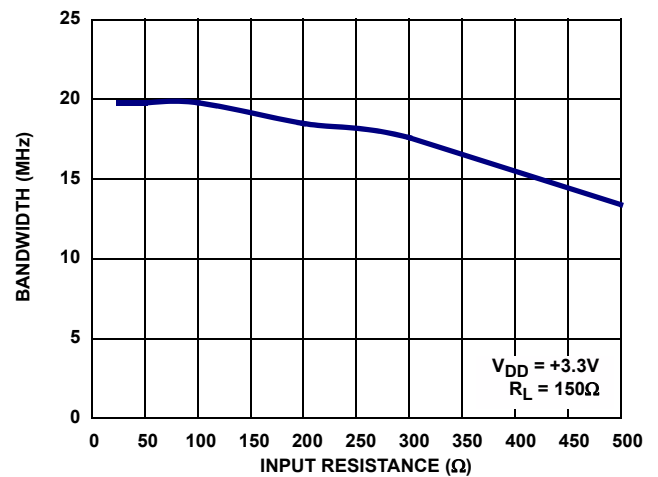

FIGURE 18. -3dB BANDWIDTH vs INPUT RESISTANCE

Typical Performance Curves $V_{DD} = +3.3V$, $R_L = 150\Omega$, unless otherwise noted (Continued)

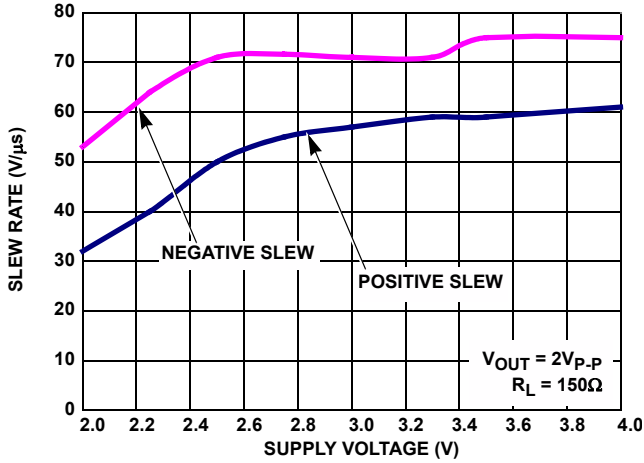

FIGURE 19. SLEW RATE vs SUPPLY VOLTAGE

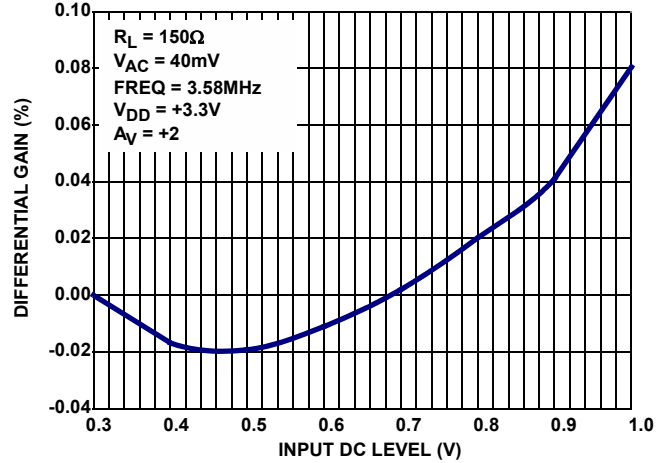

FIGURE 20. DIFFERENTIAL GAIN

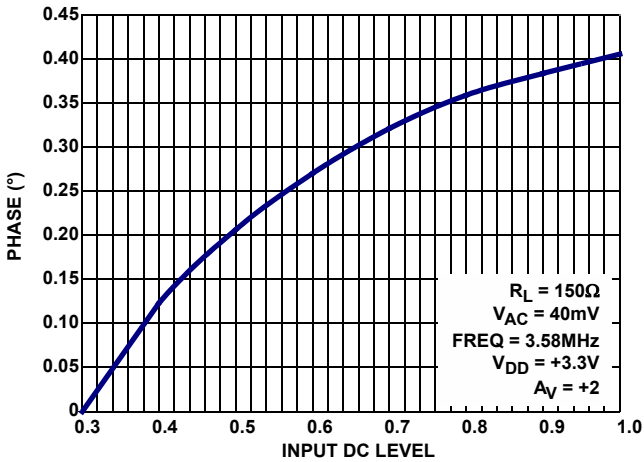

FIGURE 21. DIFFERENTIAL PHASE

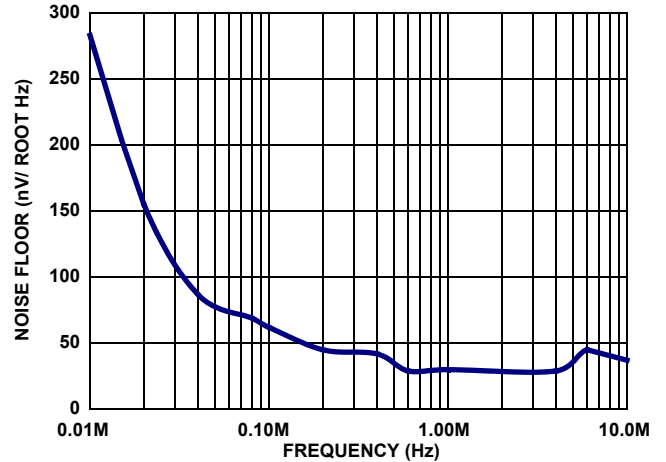

FIGURE 22. UNWEIGHTED NOISE FLOOR

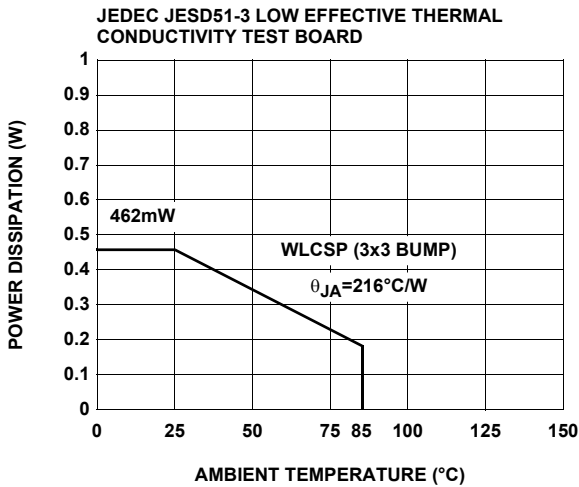

FIGURE 23. PACKAGE POWER DISSIPATION vs AMBIENT TEMPERATURE

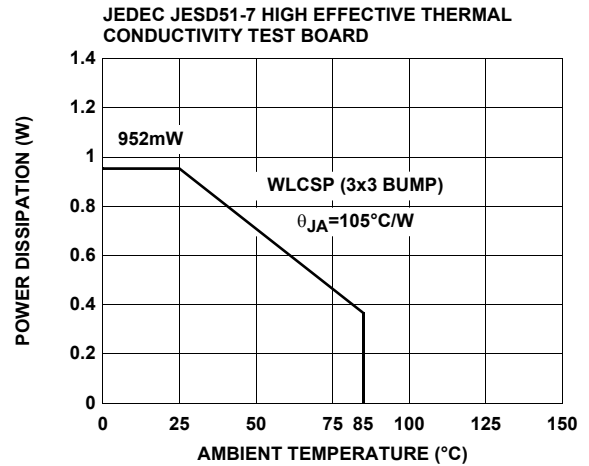

FIGURE 24. PACKAGE POWER DISSIPATION vs AMBIENT TEMPERATURE

Application Information

The ISL59123 is a single-supply rail-to-rail triple video low-pass filter and amplifier with a -3dB bandwidth of 18MHz. It provides anti-aliasing for component, s-video, and composite video signals. Its small size and low power make the ISL59123 ideal for portable video applications.

The Sallen Key Low Pass Filter

The Sallen Key is a classic low pass configuration. This provides a very stable low pass function, and in the case of the ISL59123, a three-pole roll-off at 18MHz. The three-pole function is accomplished with an RC low pass network placed in series with and before the Sallen Key. The first pole is formed by an RC network (including the impedance of the source driving the ISL59123), with poles two and three generated by a Sallen Key, creating a three-pole roll-off characteristic at 18MHz.

Output Coupling

The ISL59123 can be AC or DC coupled to its output. When AC coupled, a 220μF coupling capacitor is recommended to ensure that low frequencies are passed, preventing video “tilt” or “droop” across a line.

Output Drive Capability

The ISL59123 does not have internal short circuit protection circuitry. If the output is shorted indefinitely, the power dissipation could easily overheat the die or the current could eventually compromise metal integrity. Maximum reliability is maintained if the output current never exceeds ±40mA. This limit is set by the design of the internal metal interconnect. Note that for transient short circuits, the part is robust.

Short circuit protection can be provided externally with a back match resistor in series with the output placed close as possible to the output pin. In video applications this would be a 75Ω resistor and will provide adequate short circuit protection to the device. Care should still be taken not to stress the device with a short at the output.

Power Dissipation

With the high output drive capability of the ISL59123, it is possible to exceed the +125°C absolute maximum junction temperature under certain load current conditions. Therefore, it is important to calculate the maximum junction temperature for an application to determine if load conditions or package types need to be modified to assure operation of the amplifier in a safe operating area.

The maximum power dissipation allowed in a package is determined according to Equation 1:

$$PD_{MAX} = \frac{T_{JMAX} - T_{AMAX}}{\theta_{JA}} \quad (\text{EQ. 1})$$

Where:

T_{JMAX} = Maximum junction temperature

T_{AMAX} = Maximum ambient temperature

θ_{JA} = Thermal resistance of the package

The maximum power dissipation actually produced by an IC is the total quiescent supply current times the total power supply voltage, plus the power in the IC due to the load, or:

for sourcing use Equation 2:

$$PD_{MAX} = V_S \times I_{SMAX} + (V_S - V_{OUT}) \times \frac{V_{OUT}}{R_L} \quad (\text{EQ. 2})$$

for sinking use Equation 3:

$$PD_{MAX} = V_S \times I_{SMAX} + (V_{OUT} - V_S) \times I_{LOAD} \quad (\text{EQ. 3})$$

Where:

V_S = Supply voltage

I_{SMAX} = Maximum quiescent supply current

V_{OUT} = Maximum output voltage of the application

R_{LOAD} = Load resistance tied to ground

I_{LOAD} = Load current

Power Supply Bypassing Printed Circuit Board Layout

As with any modern operational amplifier, a good printed circuit board layout is necessary for optimum performance. Lead lengths should be as short as possible. The power supply pin must be well bypassed to reduce the risk of oscillation. For normal single supply operation, a single 4.7μF tantalum capacitor in parallel with a 0.1μF ceramic capacitor from V_{DD} to GND will suffice.

Printed Circuit Board Layout

For good AC performance, parasitic capacitance should be kept to minimum. Use of wire wound resistors should be avoided because of their additional series inductance. Use of sockets should also be avoided if possible. Sockets add parasitic inductance and capacitance that can result in compromised performance.

Wafer Level Chip Scale Package (WLCSP)

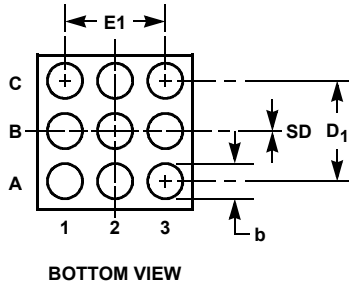
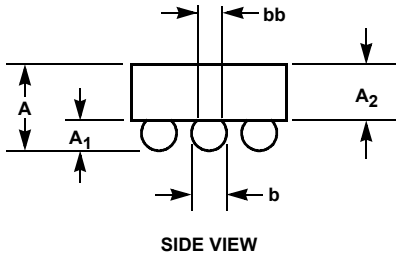
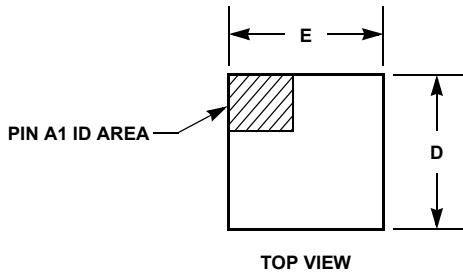

W3x3.9B

3x3 ARRAY 9 BALL WAFER LEVEL CHIP SCALE PACKAGE (Intersil Standard)

SYMBOL	MILLIMETERS	NOTES
A	0.54 Min, 0.65 Max	-
A ₁	0.24 ±0.03	-
A ₂	0.355 ±0.03	-
b	0.32 ±0.03	-
bb	Ø 0.30 REF.	-
D	1.45 ±0.05	-
D ₁	1.00 BASIC	-
E	1.45 ±0.05	-
E ₁	1.00 BASIC	-
e	0.50 BASIC	-
SD	0.00 BASIC	-
N	9	3

Rev. 0 6/06

NOTES:

1. Dimensions are in Millimeters.
2. Dimensioning and tolerancing conform to ASME 14.5M-1994.
3. Symbol "N" is the actual number of solder balls.
4. Reference JEDEC MO-211-C, variation DD.

All Intersil U.S. products are manufactured, assembled and tested utilizing ISO9001 quality systems. Intersil Corporation's quality certifications can be viewed at www.intersil.com/design/quality

Intersil products are sold by description only. Intersil Corporation reserves the right to make changes in circuit design, software and/or specifications at any time without notice. Accordingly, the reader is cautioned to verify that data sheets are current before placing orders. Information furnished by Intersil is believed to be accurate and reliable. However, no responsibility is assumed by Intersil or its subsidiaries for its use; nor for any infringements of patents or other rights of third parties which may result from its use. No license is granted by implication or otherwise under any patent or patent rights of Intersil or its subsidiaries.

For information regarding Intersil Corporation and its products, see www.intersil.com