



Chipsmall Limited consists of a professional team with an average of over 10 year of expertise in the distribution of electronic components. Based in Hongkong, we have already established firm and mutual-benefit business relationships with customers from,Europe,America and south Asia,supplying obsolete and hard-to-find components to meet their specific needs.

With the principle of “Quality Parts,Customers Priority,Honest Operation,and Considerate Service”,our business mainly focus on the distribution of electronic components. Line cards we deal with include Microchip,ALPS,ROHM,Xilinx,Pulse,ON,Everlight and Freescale. Main products comprise IC,Modules,Potentiometer,IC Socket,Relay,Connector.Our parts cover such applications as commercial,industrial, and automotives areas.

We are looking forward to setting up business relationship with you and hope to provide you with the best service and solution. Let us make a better world for our industry!



Contact us

Tel: +86-755-8981 8866 Fax: +86-755-8427 6832

Email & Skype: info@chipsmall.com Web: www.chipsmall.com

Address: A1208, Overseas Decoration Building, #122 Zhenhua RD., Futian, Shenzhen, China



Dual LDO with Low Noise, High Performance and Low I_Q

ISL78302

ISL78302 is a high performance dual LDO capable of sourcing 300mA current from each output. It has a low standby current and is stable with an output capacitance of 1µF to 10µF and an ESR of up to 200mΩ.

The device integrates an individual Power-On-Reset (POR) function for each output. The POR delay for VO2 can be externally programmed by connecting a timing capacitor to the CPOR pin. The POR delay for VO1 is internally fixed at approximately 2ms. A reference bypass pin is also provided for connecting a noise filtering capacitor for low noise and high-PSRR applications.

The quiescent current is typically only 47µA with both LDOs enabled and active. Separate enable pins control each individual LDO output. When both enable pins are low, the device is in shutdown, typically drawing less than 0.5µA.

The part operates down to 2.3V and up to 6.5V input. The typical output voltage can be as low as 1.2V and as high as 3.3V for each regulator. Please refer to the "Ordering Information" on page 3 for standard options.

The ISL78302 is AEC-Q100 qualified at the automotive temperature range of -40 °C to +105 °C.

Features

- Integrates two 300mA high performance LDOs
- Excellent transient response to large current steps
- ±1.8% Accuracy over all operating conditions
- Excellent load regulation: <0.1% voltage change across full range of load current
- Extremely low quiescent current: 47µA (both LDOs active)
- Wide input voltage capability: 2.3V to 6.5V
- Low dropout voltage: typically 300mV at 300mA
- Low output noise: typically 37µV_{RMS} at 100µA (1.5V)
- Stable with 1µF to 10µF ceramic capacitors
- Separate enable and POR pins for each LDO
- Soft-start and staged turn-on to limit input current surge during enable
- Current limit and over-temperature protection
- Tiny 10 Lead 3mm x 3mm DFN package
- AEC-Q100 qualified
- Pb-free (RoHS Compliant)

Applications

- Radio receivers
- Camera modules
- GPS/navigation
- Infotainment systems

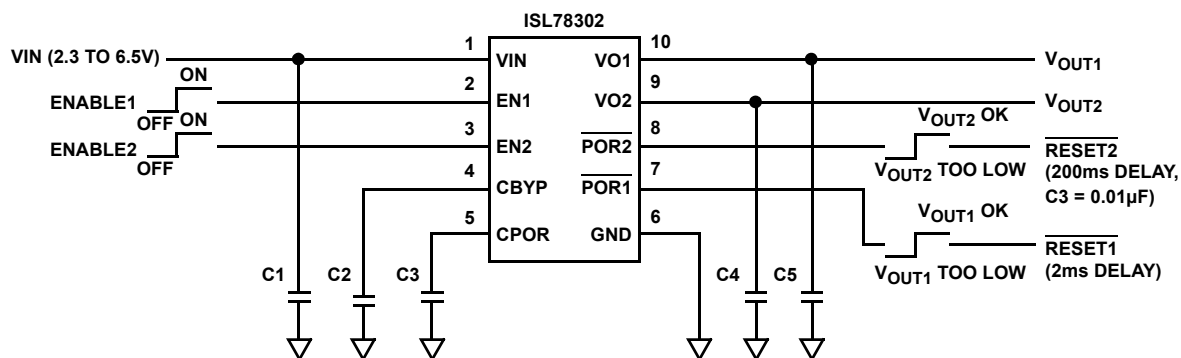

C1, C4, C5: 1µF X5R CERAMIC CAPACITOR
 C2: 0.01µF X7R CERAMIC CAPACITOR
 C3: 0.01µF X7R CERAMIC CAPACITOR

FIGURE 1. TYPICAL APPLICATION

Block Diagram

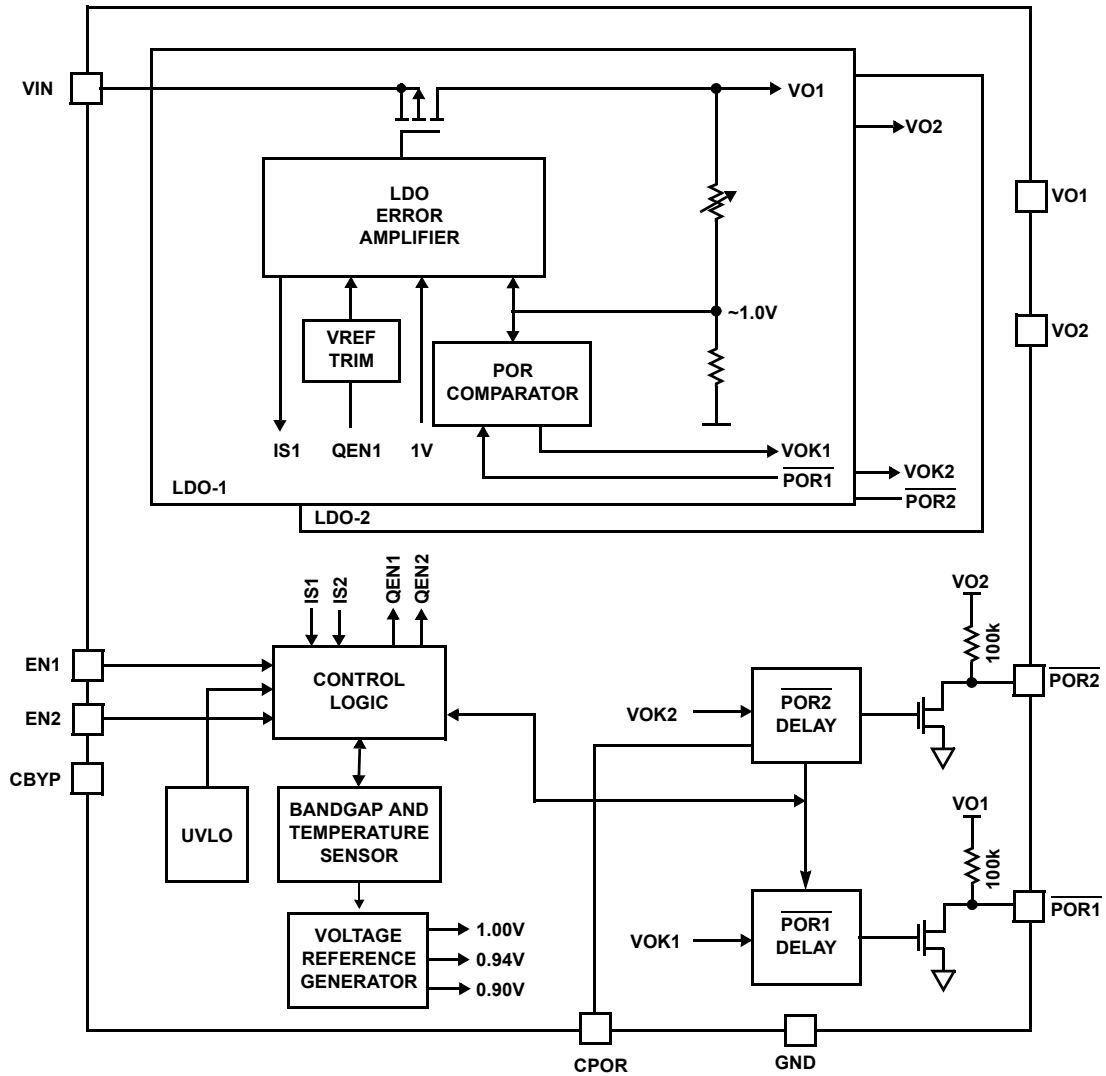

ISL78302

Pin Configuration

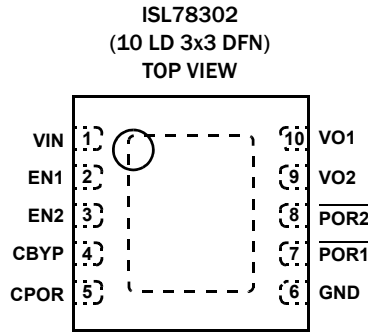

Pin Descriptions

PIN NUMBER	PIN NAME	TYPE	DESCRIPTION
1	VIN	Analog I/O	Supply Voltage/LDO Input. Connect a 1 μ F capacitor to GND.
2	EN1	Low Voltage Compatible CMOS Input	LDO-1 Enable. ENABLE = HIGH
3	EN2	Low Voltage Compatible CMOS Input	LDO-2 Enable. ENABLE = HIGH
4	CBYP	Analog I/O	Reference Bypass Capacitor Pin. Recommended to connect capacitor of value 0.01 μ F between this pin and GND for optimum noise and PSRR performance.
5	CPOR	Analog I/O	POR2 Delay Setting Capacitor Pin. Connect a capacitor between this pin and GND to delay the POR2 output release after LDO-2 output reaches 94% of its specified voltage level. (200ms delay per 0.01 μ F).
6	GND	Ground	GND is the connection to system ground. Connect to PCB Ground plane.
7	$\overline{\text{POR1}}$	Open-Drain Output (1mA)	Open-drain POR Output for LDO-1 (active-low). Internally connected to VO1 through 100k Ω resistor.
8	$\overline{\text{POR2}}$	Open-Drain Output (1mA)	Open-drain POR Output for LDO-2 (active-low). Internally connected to VO2 through 100k Ω resistor.
9	VO2	Analog I/O	LDO-2 Output. Connect capacitor of value 1 μ F to 10 μ F to GND (1 μ F recommended).
10	VO1	Analog I/O	LDO-1 Output. Connect capacitor of value 1 μ F to 10 μ F to GND (1 μ F recommended).

Ordering Information

PART NUMBER (Notes 1, 2, 3)	PART MARKING	VO1 VOLTAGE (V)	VO2 VOLTAGE (V)	TEMP RANGE (°C)	PACKAGE (Pb-Free)	PKG DWG. #
ISL78302ARFBZ	DNAB	2.5	1.5	-40 to +105	10 Ld 3x3 DFN	L10.3x3C
ISL78302ARBFZ	DNAC	1.5	2.5	-40 to +105	10 Ld 3x3 DFN	L10.3x3C
ISL78302ARNBZ	DNAD	3.3	1.5	-40 to +105	10 Ld 3x3 DFN	L10.3x3C
ISL78302ARBNZ	DNAE	1.5	3.3	-40 to +105	10 Ld 3x3 DFN	L10.3x3C
ISL78302ARNWZ	DNAF	3.3	1.2	-40 to +105	10 Ld 3x3 DFN	L10.3x3C
ISL78302ARWCZ	DNAG	1.2	1.8	-40 to +105	10 Ld 3x3 DFN	L10.3x3C
ISL78302ARFWZ	DNAH	2.5	1.2	-40 to +105	10 Ld 3x3 DFN	L10.3x3C
ISL78302ARCWZ	DNAJ	1.8	1.2	-40 to +105	10 Ld 3x3 DFN	L10.3x3C
ISL78302AR1AZ	DNAV	1.25	3.3	-40 to +105	10 Ld 3x3 DFN	L10.3x3C

NOTES:

1. Add "-T*" suffix for tape and reel. Please refer to [TB347](#) for details on reel specifications.
2. These Intersil Pb-free plastic packaged products employ special Pb-free material sets, molding compounds/die attach materials, and 100% matte tin plate plus anneal (e3 termination finish, which is RoHS compliant and compatible with both SnPb and Pb-free soldering operations). Intersil Pb-free products are MSL classified at Pb-free peak reflow temperatures that meet or exceed the Pb-free requirements of IPC/JEDEC J STD-020.
3. For Moisture Sensitivity Level (MSL), please see device information page for [ISL78302](#). For more information on MSL please see techbrief [TB363](#).

ISL78302

Absolute Maximum Ratings

Supply Voltage (V_{IN})	+7.1V
V_{O1} , V_{O2} Pins	+3.6V
All Other Pins	-0.3 to ($V_{IN} + 0.3$)V
ESD Ratings	
Human Body Model (Tested per JESD22-A114E)	3kV
Machine Model (Tested per JESD-A115-A)	200V
Charge Device Model (Tested Per AEC-Q100-011)	2kV

Thermal Information

Thermal Resistance (Notes 4, 5)	θ_{JA} ($^{\circ}\text{C}/\text{W}$)	θ_{JC} ($^{\circ}\text{C}/\text{W}$)
10 Ld 3x3 DFN Package	59	18.5
Junction Temperature Range	-40 $^{\circ}\text{C}$ to +125 $^{\circ}\text{C}$	
Operating Temperature Range	-40 $^{\circ}\text{C}$ to +105 $^{\circ}\text{C}$	
Storage Temperature Range	-65 $^{\circ}\text{C}$ to +150 $^{\circ}\text{C}$	
Pb-Free Reflow Profile	see TB493	

Recommended Operating Conditions

Ambient Temperature Range (T_A)	-40 $^{\circ}\text{C}$ to +105 $^{\circ}\text{C}$
Supply Voltage (V_{IN})	2.3V to 6.5V

CAUTION: Do not operate at or near the maximum ratings listed for extended periods of time. Exposure to such conditions may adversely impact product reliability and result in failures not covered by warranty.

NOTES:

- θ_{JA} is measured in free air with the component mounted on a high effective thermal conductivity test board with “direct attach” features. See Tech Brief [TB379](#).
- For θ_{JC} , the “case temp” location is the center of the exposed metal pad on the package underside.

Electrical Specifications Unless otherwise noted, all parameters are guaranteed over the operational supply voltage and temperature range of the device as follows: $T_A = -40^{\circ}\text{C}$ to +105 $^{\circ}\text{C}$; $V_{IN} = (V_O + 0.5\text{V})$ to 6.5V with a minimum V_{IN} of 2.3V; $C_{IN} = 1\mu\text{F}$; $C_O = 1\mu\text{F}$; $C_{BYP} = 0.01\mu\text{F}$; $C_{POR} = 0.01\mu\text{F}$. **Boldface limits apply across the operating temperature range, -40 $^{\circ}\text{C}$ to +105 $^{\circ}\text{C}$.**

PARAMETER	SYMBOL	TEST CONDITIONS	MIN (Note 7)	TYP	MAX (Note 7)	UNITS
DC CHARACTERISTICS						
Supply Voltage	V_{IN}		2.3		6.5	V
Ground Current		Quiescent condition: $I_{O1} = 0\mu\text{A}$; $I_{O2} = 0\mu\text{A}$				
	I_{DD1}	One LDO active		30	36	μA
	I_{DD2}	Both LDO active		47	55	μA
Shutdown Current	I_{DDS}			0.3	2.1	μA
UVLO Threshold	V_{UV+}		1.9	2.1	2.3	V
	V_{UV-}		1.6	1.8	2.0	V
Regulation Voltage Accuracy		$V_{IN} = V_O + 0.5\text{V}$ to 5.5V, $I_O = 10\mu\text{A}$ to 300mA, $T_J = +25^{\circ}\text{C}$	-0.8		+0.8	%
		$V_{IN} = V_O + 0.5\text{V}$ to 5.5V, $I_O = 10\mu\text{A}$ to 300mA, $T_J = -40^{\circ}\text{C}$ to +105 $^{\circ}\text{C}$	-1.8		+1.8	%
Maximum Output Current	I_{MAX}	Continuous	300			mA
Internal Current Limit	I_{LIM}		320	475	650	mA
Dropout Voltage (Note 6)	V_{DO}	$I_O = 300\text{mA}$		300		mV
		$I_O = 150\text{mA}$		150	250	mV
Thermal Shutdown Temperature	T_{SD+}			145		$^{\circ}\text{C}$
	T_{SD-}			110		$^{\circ}\text{C}$
AC CHARACTERISTICS						
Ripple Rejection		$I_O = 10\text{mA}$, $V_{IN} = 2.8\text{V}(\text{min})$, $V_O = 1.5\text{V}$, $C_{BYP} = 0.01\mu\text{F}$				
		at 1kHz		64		dB
		at 10kHz		51		dB
		at 100kHz		38		dB

ISL78302

Electrical Specifications Unless otherwise noted, all parameters are guaranteed over the operational supply voltage and temperature range of the device as follows: $T_A = -40^\circ\text{C}$ to $+105^\circ\text{C}$; $V_{IN} = (V_O + 0.5\text{V})$ to 6.5V with a minimum V_{IN} of 2.3V ; $C_{IN} = 1\mu\text{F}$; $C_O = 1\mu\text{F}$; $C_{BYP} = 0.01\mu\text{F}$; $C_{POR} = 0.01\mu\text{F}$. **Boldface limits apply across the operating temperature range, -40°C to $+105^\circ\text{C}$. (Continued)**

PARAMETER	SYMBOL	TEST CONDITIONS	MIN (Note 7)	TYP	MAX (Note 7)	UNITS
Output Noise Voltage		$I_O = 100\mu\text{A}$, $V_O = 1.5\text{V}$, $T_A = +25^\circ\text{C}$, $C_{BYP} = 0.01\mu\text{F}$ $\text{BW} = 10\text{Hz}$ to 100kHz		37		μV_{RMS}
DEVICE START-UP CHARACTERISTICS						
Device Enable Time	t_{EN}	Time from assertion of the ENx pin to when the output voltage reaches 95% of the $V_{O(\text{nom})}$		250	500	μs
LDO Soft-start Ramp Rate	t_{SSR}	Slope of linear portion of LDO output voltage ramp during start-up, $V_{\text{OUT}} > 1.25\text{V}$		30	60	$\mu\text{s}/\text{V}$
		Slope of linear portion of LDO output voltage ramp during start-up, $V_{\text{OUT}} \leq 1.25\text{V}$		40	80	$\mu\text{s}/\text{V}$
EN1, EN2 PIN CHARACTERISTICS						
Input Low Voltage	V_{IL}		-0.3		0.5	V
Input High Voltage	V_{IH}		1.35		$V_{\text{IN}} + 0.3$	V
Input Leakage Current	I_{IL} , I_{IH}				0.1	μA
Pin Capacitance	C_{PIN}	Informative		5		pF
POR1, POR2 PIN CHARACTERISTICS						
$\overline{\text{POR1}}$, $\overline{\text{POR2}}$ Thresholds	$V_{\text{POR+}}$	As a percentage of nominal output voltage	91	94	97	%
	$V_{\text{POR-}}$		87	90	93	%
$\overline{\text{POR1}}$ Delay	t_{P1LH}		0.5	2.0	3.2	ms
	t_{P1HL}			25		μs
$\overline{\text{POR2}}$ Delay	t_{P2LH}	$C_{\text{POR}} = 0.01\mu\text{F}$	100	200	300	ms
	t_{P2HL}			25		μs
$\overline{\text{POR1}}$, $\overline{\text{POR2}}$ Pin Output Low Voltage	V_{OL}	at $I_{\text{OL}} = 1.0\text{mA}$			0.2	V
$\overline{\text{POR1}}$, $\overline{\text{POR2}}$ Pin Internal Pull-up Resistance	R_{POR}		78	100	180	k Ω

NOTES:

- $V_{\text{OX}} = 0.98 \cdot V_{\text{OX(NOM)}}$; Valid for V_{OX} greater than 1.85V .
- Compliance to datasheet limits is assured by one or more methods: production test, characterization and/or design.

ISL78302

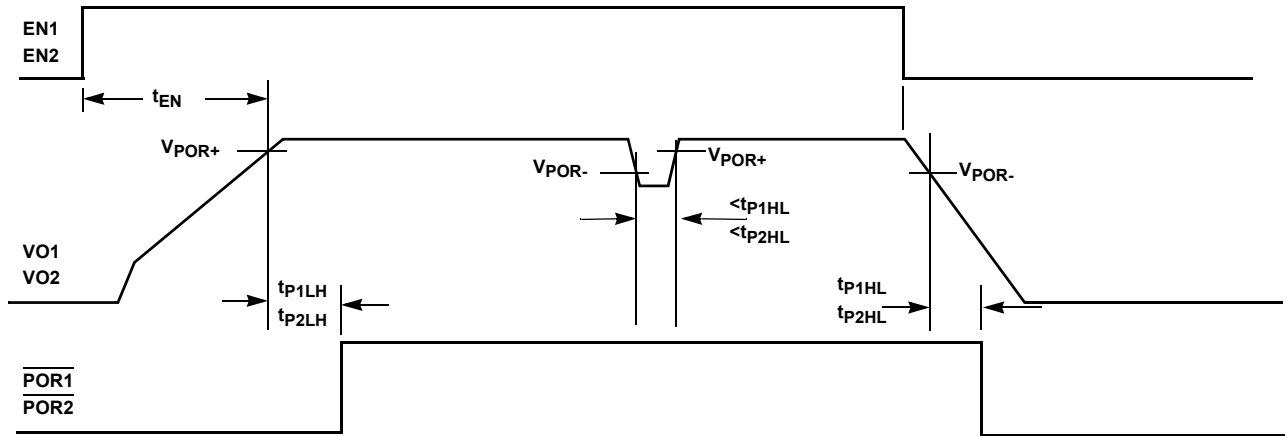

FIGURE 2. TIMING PARAMETER DEFINITION

Typical Performance Curves

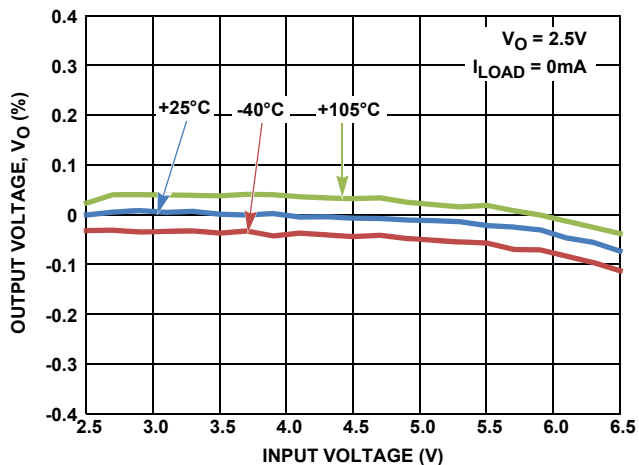

FIGURE 3. LINE REGULATION (2.5V OUTPUT)

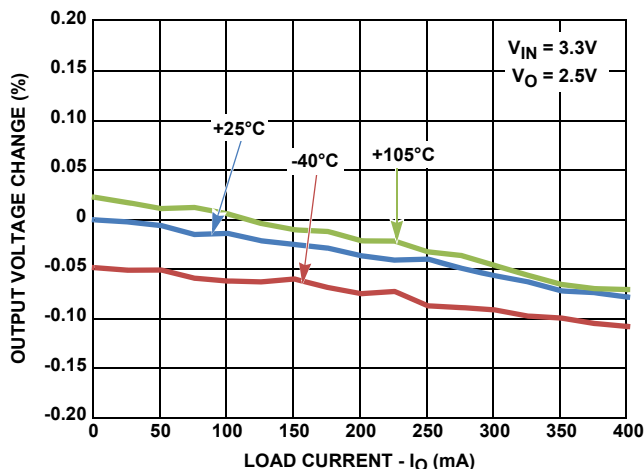

FIGURE 4. LOAD REGULATION

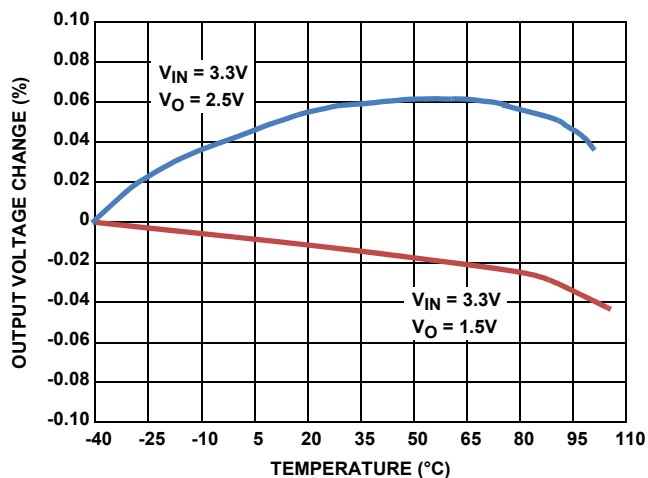

FIGURE 5. OUTPUT VOLTAGE CHANGE vs TEMPERATURE

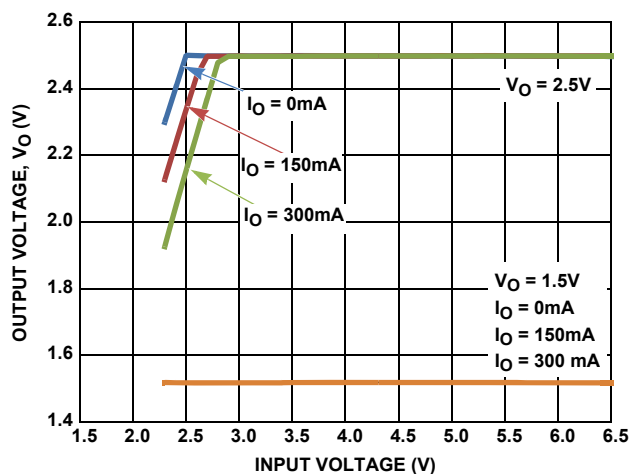

FIGURE 6. OUTPUT VOLTAGE vs INPUT VOLTAGE (2.5V AND 1.5V OUTPUT)

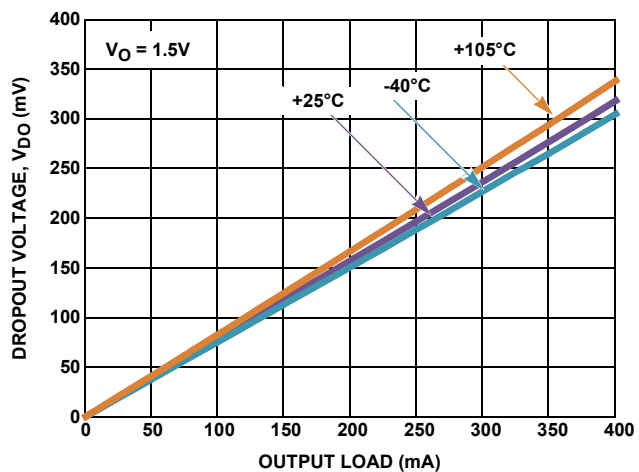

FIGURE 7. DROPOUT VOLTAGE vs LOAD CURRENT

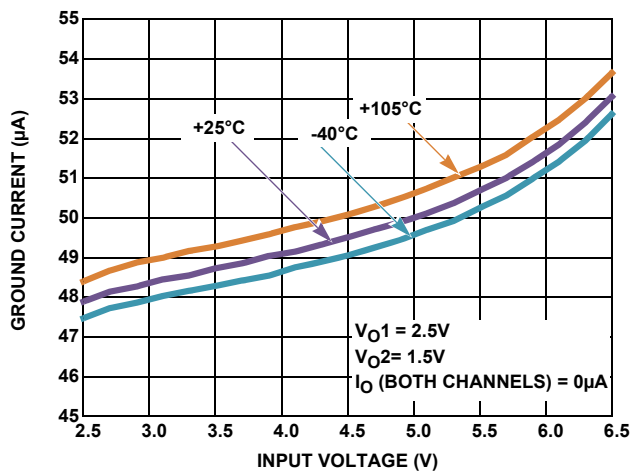

FIGURE 8. GROUND CURRENT vs INPUT VOLTAGE

Typical Performance Curves (Continued)

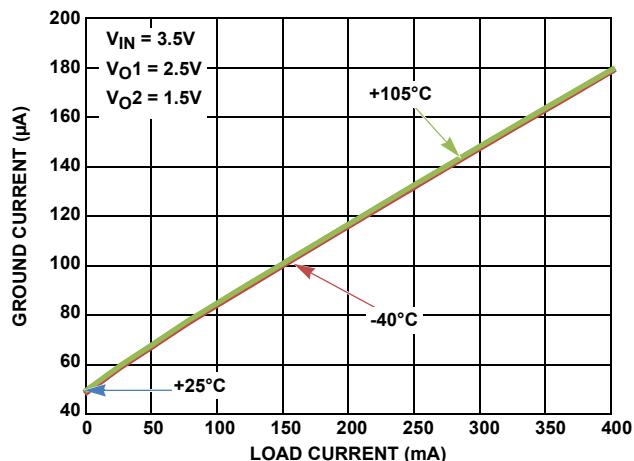

FIGURE 9. GROUND CURRENT vs LOAD

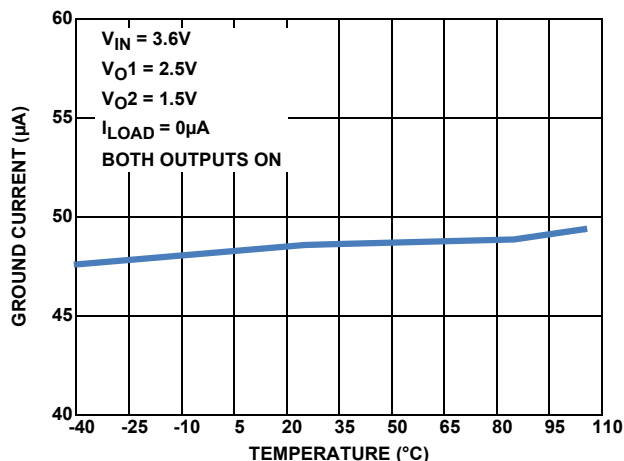

FIGURE 10. GROUND CURRENT vs TEMPERATURE

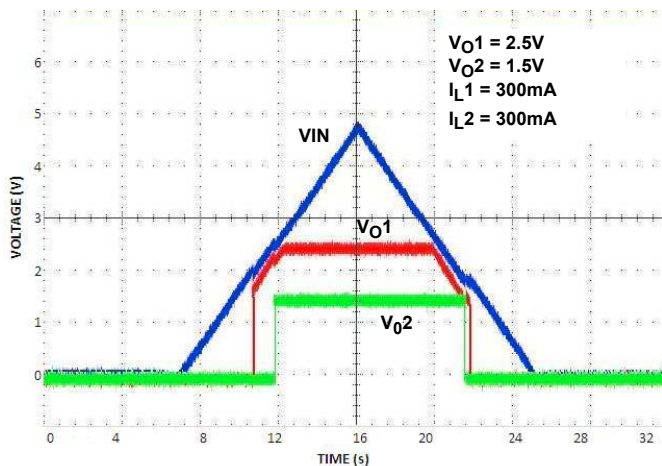

FIGURE 11. POWER-UP/POWER-DOWN

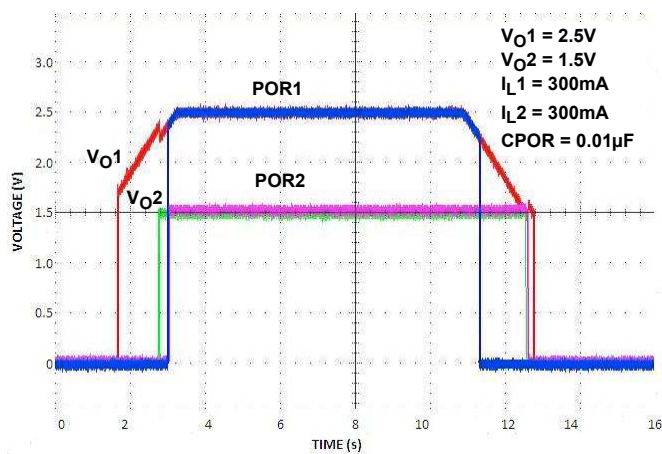

FIGURE 12. POWER-UP/POWER-DOWN WITH POR SIGNALS

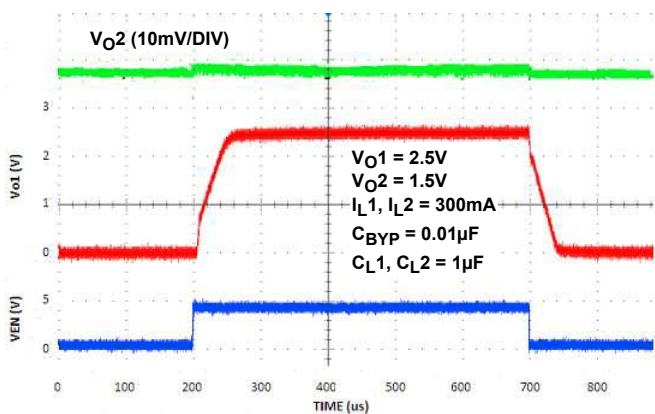

FIGURE 13. TURN-ON/TURN-OFF RESPONSE

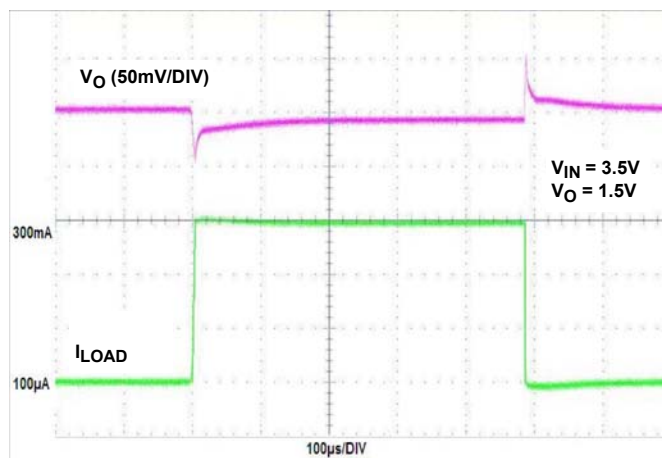

FIGURE 14. LOAD TRANSIENT RESPONSE

Typical Performance Curves (Continued)

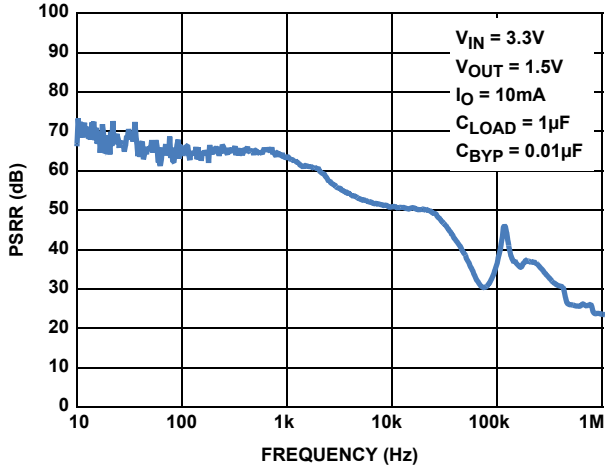

FIGURE 15. PSRR vs FREQUENCY

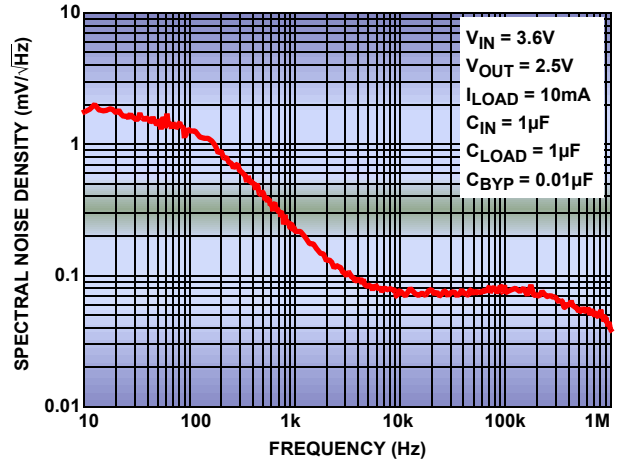

FIGURE 16. SPECTRAL NOISE DENSITY vs FREQUENCY (2.5V OUTPUT, 10mA LOAD)

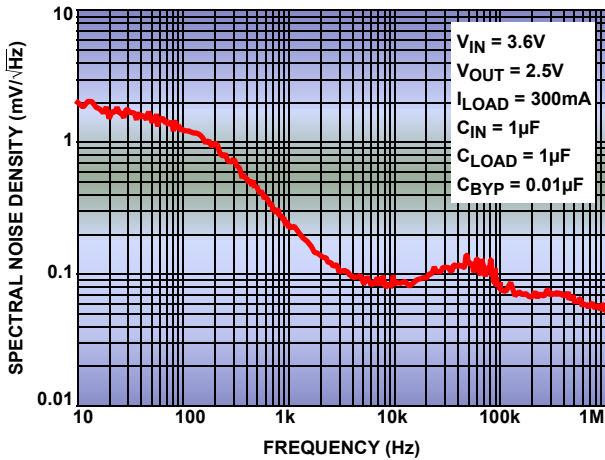

FIGURE 17. SPECTRAL NOISE DENSITY vs FREQUENCY (2.5V OUTPUT, 300mA LOAD)

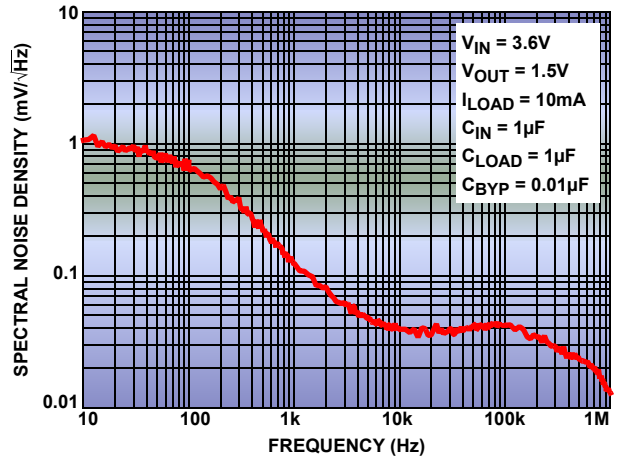

FIGURE 18. SPECTRAL NOISE DENSITY vs FREQUENCY (1.5V OUTPUT, 10mA LOAD)

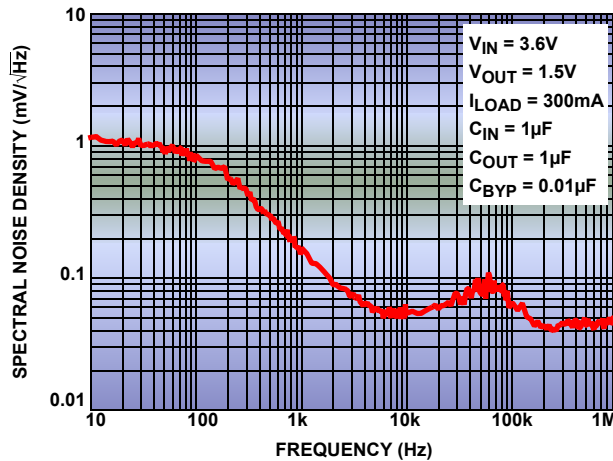

FIGURE 19. SPECTRAL NOISE DENSITY vs FREQUENCY (1.5V OUTPUT, 300mA LOAD)

Functional Description

The ISL78302 contains two high performance LDOs. High performance is achieved through a circuit that delivers fast transient response to varying load conditions. In a quiescent condition, the ISL78302 adjusts its biasing to achieve the lowest standby current consumption.

The device also integrates current limit protection, smart thermal shutdown protection, staged turn-on and soft-start. Smart thermal shutdown protects the device against overheating. Staged turn-on and soft-start minimize start-up input current surges without causing excessive device turn-on time.

Power Control

The ISL78302 has two separate enable pins (EN1 and EN2) to individually control power to each of the LDO outputs. When both EN1 and EN2 are low, the device is in shutdown mode. During this condition, all on-chip circuits are off, and the device draws minimum current, typically less than 0.5 μ A.

When one or both of the enable pins is asserted, the device first polls the output of the UVLO detector to ensure that VIN voltage is at least about 2.1V. Once verified, the device initiates a start-up sequence. During the start-up sequence, trim settings are first read and latched. Then, sequentially, the bandgap, reference voltage and current generation circuitry power-up. Once the references are stable, a fast-start circuit quickly charges the external reference bypass capacitor (connected to the CBYP pin) to the proper operating voltage. After the bypass capacitor has been charged, the LDOs power-up in their specified sequence.

Soft-start circuitry integrated into each LDO limits the initial ramp-up rate to about 30 μ s/V to minimize current surge.

If EN1 is brought high and EN2 goes high before the VO1 output stabilizes, the ISL78302 delays the VO2 turn-on until the VO1 output reaches its target level.

If EN2 is brought high and EN1 goes high before VO2 starts its output ramp, then VO1 turns on first and, the ISL78302 delays the VO2 turn-on until the VO1 output reaches its target level.

If EN2 is brought high and EN1 goes high after VO2 starts its output ramp, then the ISL78302 immediately starts to ramp up the VO1 output.

If both EN1 and EN2 are brought high at the same time, the VO1 output has priority and is always powered up first.

During operation, whenever the VIN voltage drops below 1.8V, the ISL78302 immediately disables both LDO outputs. When VIN rises back above 2.1V, the device reinitiates its start-up sequence, and LDO operation will resume automatically.

Reference Generation

The reference generation circuitry includes a trimmed bandgap, a trimmed voltage reference divider, a trimmed current reference generator, and an RC noise filter. The filter includes the external capacitor connected to the CBYP pin. A 0.01 μ F (capacitor connected CBYP) implements a 100Hz lowpass filter and is recommended for most high-performance applications. Capacitor values above 0.01 μ F are not recommended for the CBYP pin.

The bandgap generates a zero temperature coefficient (TC) voltage for the reference divider. The reference divider provides the regulation reference, POR detection thresholds, and other voltage references required for current generation and over-temperature detection.

The current generator provides the references required for adaptive biasing as well as references for LDO output current limit and thermal shutdown determination.

LDO Regulation and Programmable Output Divider

The LDO regulator is implemented with a high-gain operational amplifier driving a PMOS pass transistor. The design of the ISL78302 provides a regulator that has low quiescent current, fast transient response, and overall stability across all operating and load current conditions. LDO stability is guaranteed for a 1 μ F to 10 μ F output capacitor that has a tolerance better than 20% and an ESR less than 200m Ω . The design is performance-optimized for a 1 μ F capacitor. Unless limited by the application, use of an output capacitor value above 4.7 μ F is not normally needed, as LDO performance improvement is minimal.

Each LDO uses an independently trimmed 1V reference. An internal resistor divider drops the LDO output voltage down to 1V. This is compared to the 1V reference for regulation. The resistor division ratio is programmed in the factory to the output voltages of 1.2V, 1.5V, 1.8V, 2.5V and 3.3V.

Power-On Reset Generation

Each LDO has a separate Power-on Reset signal generation circuit, which outputs to the respective $\overline{\text{POR}}$ pins. The POR signal is generated as follows.

A POR comparator continuously monitors the output of each LDO. The LDO enters a power-good state when the output voltage is above 94% of the expected output voltage for a period exceeding the LDO PGOOD entry delay time. In the power-good state, the open-drain $\overline{\text{PORx}}$ output is in a high-impedance state. An internal 100k Ω pull-up resistor pulls the pin up to the respective LDO output voltage. An external resistor can be added between the $\overline{\text{PORx}}$ output and the LDO output for a faster rise time; however, the $\overline{\text{PORx}}$ output should not connect through an external resistor to a supply greater than the associated LDO voltage.

The ISL78302 offers 1.2V and 1.5V regulated outputs in several options. On these low output voltage versions, it has been found that the internal pull-ups on POR outputs do not always function correctly above $V_{\text{IN}} = 3.9\text{V}$. For this reason, it is recommended to use an external 100k Ω pull-up resistor for either POR pin if its associated output is either 1.2V or 1.5V. For outputs higher than 1.5V, no external resistor is required over the full input range from 2.3V to 6.5V.

The power-good state is exited when the LDO output falls below 90% of the expected output voltage for a period longer than the PGOOD exit delay time. While power-good is false, the ISL78302 pulls the respective $\overline{\text{POR}}$ pin low.

For LDO-1, the PGOOD entry delay time is fixed at about 2ms, while the PGOOD exit delay is about 25 μ s. For LDO-2, the PGOOD entry and exit delays are determined by the value of the external

capacitor connected to the CPOR pin. For a 0.01 μ F capacitor, the entry and exit delays are 200ms and 25 μ s, respectively. Larger or smaller capacitor values will yield proportionately longer or shorter delay times. The POR exit delay should never be allowed to be less than 10 μ s to ensure sufficient immunity against transient induced false POR triggering.

Over-Temperature Detection

The bandgap provides a proportional-to-temperature current that indicates the temperature of the silicon. This current is compared with references to determine whether the device is in danger of damage from overheating. When the die temperature reaches about +145°C, one or both of the LDOs momentarily shuts down until the die cools sufficiently. In the overheat condition, only the LDO sourcing more than 50mA is shut off. This shutoff does not affect the operation of the other LDO. If both LDOs source more than 50mA and an overheat condition occurs, both LDO outputs are disabled. Once the die temperature falls back below about +110°C and disabled LDOs are re-enabled, the soft-start automatically takes place.

The ISL78302 provides short-circuit protection by limiting the output current to about 475mA. If short circuited, an output current of 475mA causes die heating. If the short circuit lasts long enough, the overheat detection circuit turns off the output.

Revision History

The revision history provided is for informational purposes only and is believed to be accurate, but not warranted. Please go to web to make sure you have the latest revision.

DATE	REVISION	CHANGE
November 6, 2014	FN7696.6	Changed Testing information for Charged Device Model from: Charged Device Model(Tested Per JESD22-C101C)...2kv to: with Charged Device Model(Tested Per AEC-Q100-011)..2kv
December 4, 2013	FN7696.5	Page 1: Changed last paragraph in description from: "The ISL78302 is rated for the automotive temperature range (-40 °C to +105 °C)." to: "The ISL78302 is AEC-Q100 rated. The ISL78302 is rated for the automotive temperature range (-40 °C to +105 °C)." Features bullet changed from: "Qualified for automotive applications" to: "AEC-Q100 Tested"
November 5, 2013	FN7696.4	Page 1 - Added the words "Qualified for Automotive Applications" under the Features section Page 13 - Updated L10.3x3C POD from rev 2 to rev 3. Changes from rev 2: Removed package outline and included center to center distance between lands on recommended land pattern. Removed Note 4 "Dimension b applies to the metallized terminal and is measured between 0.18mm and 0.30mm from the terminal tip."
July 31, 2013	FN7696.3	Added Part Number ISL78302AR1AZ to "Ordering Information" on page 3 Electrical Spec Table changed LDO Soft-Start Ramp Rate Test Conditions under Device Start-up Characteristics on page 5 From: $V_{OUT} > 1.2V$ to $V_{OUT} > 1.25V$ From: $V_{OUT} = 1.2V$ to $V_{OUT} \leq 1.25V$
March 15, 2012	FN7696.2	Removed "Other voltage selections are available upon request." from page 1. Corrected "VO2" to "VO1" (tied to POR1#) in "Block Diagram" on page 2. Corrected "VO4" to "VO2" (tied to POR2#) in "Block Diagram" on page 2. Removed Note 2 "For other output voltages, contact Intersil." from "Ordering Information" on page 3. Corrected part marking for ISL78302ARCWZ from DANJ to DNAJ. Added " $V_{OUT} > 1.2V$ " to conditions of "LDO Soft-start Ramp Rate" on page 5 where Typ/Max are 30/60 μ s/V. Added line for $V_{OUT} = 1.2V$ with Typ/Max specs of 40/80 μ s/V. Added paragraph to "Power-On Reset Generation" on page 10 ("The ISL78302 offers ... is required over the full input range from 2.3V to 6.5V.").
December 5, 2011	FN7696.1	Removed "Coming Soon" from parts in "Ordering Information" on page 3.
January 28, 2011	FN7696.0	Initial Release.

About Intersil

Intersil Corporation is a leading provider of innovative power management and precision analog solutions. The company's products address some of the largest markets within the industrial and infrastructure, mobile computing and high-end consumer markets.

For the most updated datasheet, application notes, related documentation and related parts, please see the respective product information page found at www.intersil.com.

You may report errors or suggestions for improving this datasheet by visiting www.intersil.com/ask.

Reliability reports are also available from our website at www.intersil.com/support

For additional products, see www.intersil.com/en/products.html

Intersil Automotive Qualified products are manufactured, assembled and tested utilizing TS16949 quality systems as noted in the quality certifications found at www.intersil.com/en/support/qualandreliability.html

Intersil products are sold by description only. Intersil Corporation reserves the right to make changes in circuit design, software and/or specifications at any time without notice. Accordingly, the reader is cautioned to verify that data sheets are current before placing orders. Information furnished by Intersil is believed to be accurate and reliable. However, no responsibility is assumed by Intersil or its subsidiaries for its use; nor for any infringements of patents or other rights of third parties which may result from its use. No license is granted by implication or otherwise under any patent or patent rights of Intersil or its subsidiaries.

For information regarding Intersil Corporation and its products, see www.intersil.com

Package Outline Drawing

L10.3x3C

10 LEAD DUAL FLAT PACKAGE (DFN)

Rev 3, 10/11

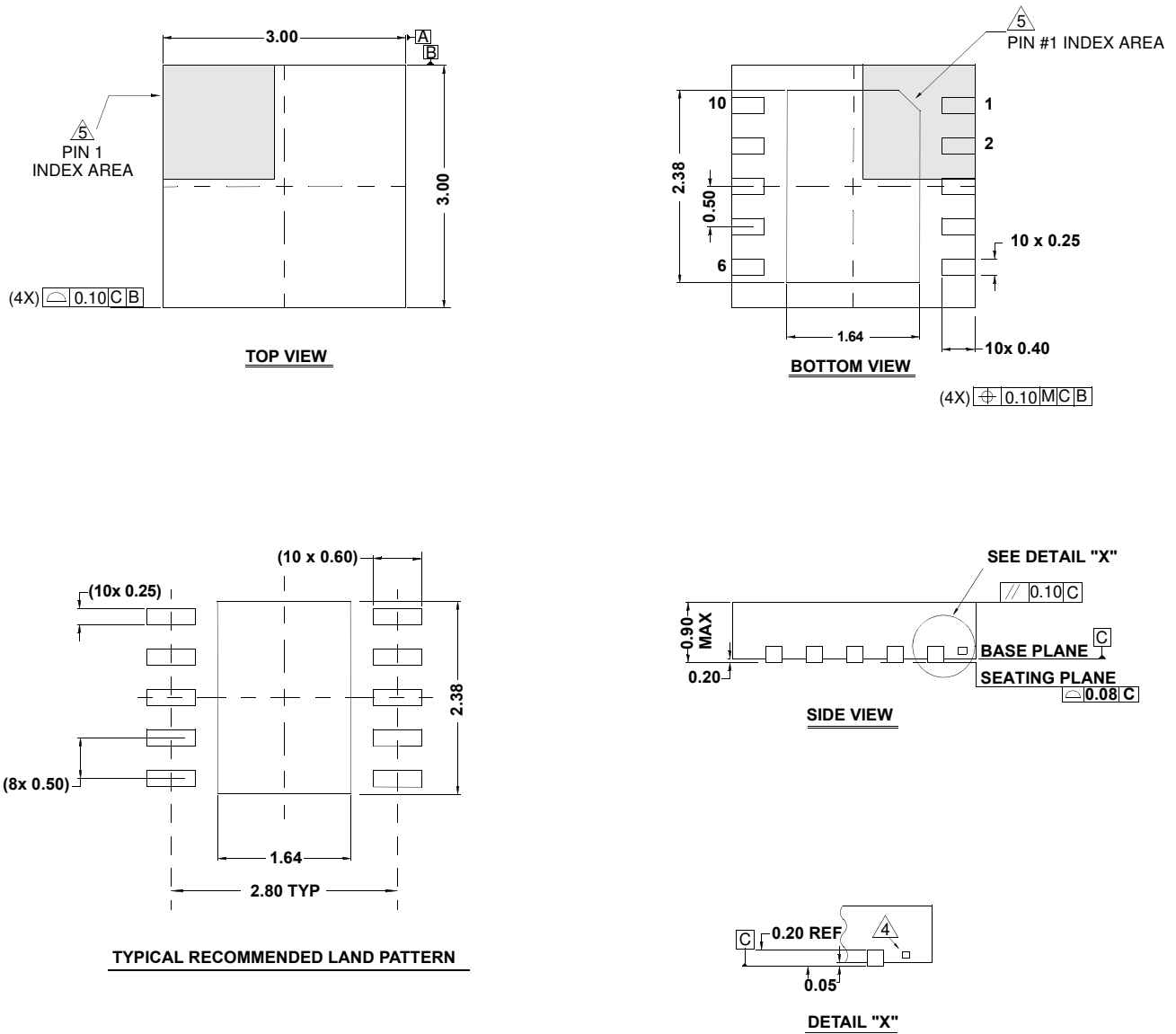

NOTES:

1. Dimensions are in millimeters.
Dimensions in () for Reference Only.
2. Dimensioning and tolerancing conform to AMSE Y14.5m-1994.
3. Unless otherwise specified, tolerance : Decimal ± 0.05
4. Tiebar shown (if present) is a non-functional feature.
5. The configuration of the pin #1 identifier is optional, but must be located within the zone indicated. The pin #1 identifier may be either a mold or mark feature.
6. COMPLIANT TO JEDEC MO-229-WEED-3 except for E-PAD dimensions.