



Chipsmall Limited consists of a professional team with an average of over 10 year of expertise in the distribution of electronic components. Based in Hongkong, we have already established firm and mutual-benefit business relationships with customers from,Europe,America and south Asia,supplying obsolete and hard-to-find components to meet their specific needs.

With the principle of “Quality Parts,Customers Priority,Honest Operation,and Considerate Service”,our business mainly focus on the distribution of electronic components. Line cards we deal with include Microchip,ALPS,ROHM,Xilinx,Pulse,ON,Everlight and Freescale. Main products comprise IC,Modules,Potentiometer,IC Socket,Relay,Connector.Our parts cover such applications as commercial,industrial, and automotives areas.

We are looking forward to setting up business relationship with you and hope to provide you with the best service and solution. Let us make a better world for our industry!



Contact us

Tel: +86-755-8981 8866 Fax: +86-755-8427 6832

Email & Skype: info@chipsmall.com Web: www.chipsmall.com

Address: A1208, Overseas Decoration Building, #122 Zhenhua RD., Futian, Shenzhen, China



ISL8203MEVAL2Z Evaluation Board User Guide

The ISL8203M is a complete, dual step-down power module with integrated PWM controller, synchronous switching MOSFETs, inductors, and passives. The ISL8203M is rated for dual 3A output current or 6A current sharing operation with an input range of 2.85V to 6V. The two channels are 180° out-of-phase for input RMS current and EMI reduction.

The simplicity of the ISL8203M is its off the shelf, unassisted implementation. It is easy to apply this complete step-down power module to any low voltage low power application.

The ISL8203MEVAL2Z evaluation board is designed to demonstrate the performance of the ISL8203M. The board is by default set up to demonstrate two 3A outputs independently, and can also be easily set up for current sharing 6A by changing placeholder resistors.

Related Resources

[ISL8203M](#) datasheet

Ordering Information

PART NUMBER	DESCRIPTION
ISL8203MEVAL2Z	ISL8203M Dual 3A/Single 6A Power Module Evaluation Board

Key Features

- V_{IN} range 2.85V to 6V
- V_{OUT} adjustable 0.8V to 5V
- Peak current limiting and hiccup mode short circuit protection
- Over-temperature protection
- Internal digital soft-start
- External synchronization up to 4MHz
- Flexibility to operate in dual output mode or parallel single output mode with simple resistor changes.
- Mechanical switch for enable and power-good LED indicator
- Connectors, test points, and jumpers for easy probing

Recommended Equipment

- 0V to 6V power supply with at least 5A source current capability
- Electronic load capable of sinking current up to 6A
- Digital multimeters (DMMs)
- 100MHz quad-trace oscilloscope

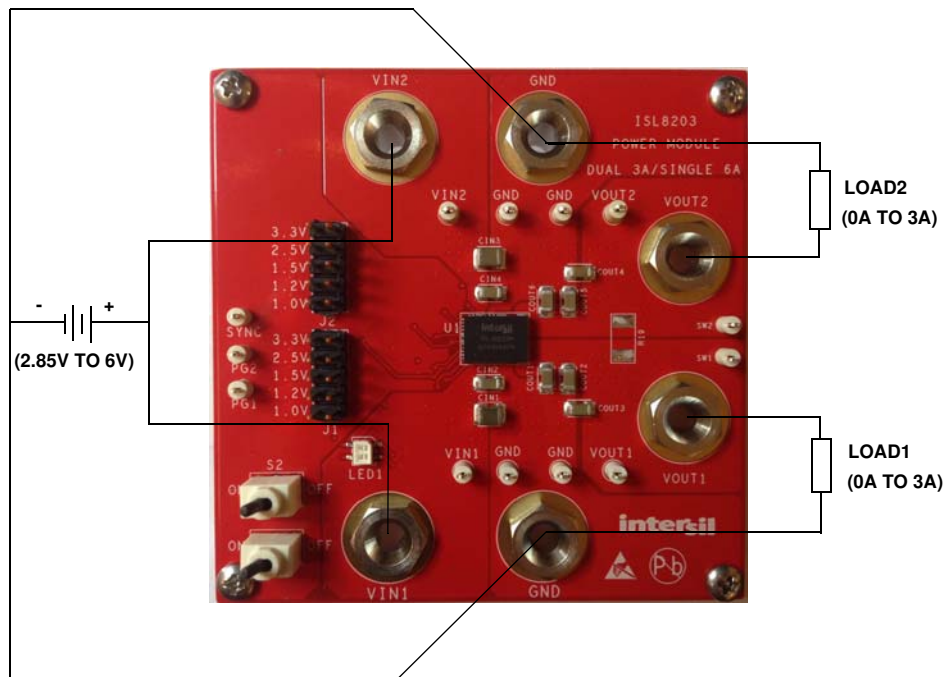

FIGURE 1. ISL8203MEVAL2Z BOARD PHOTO

Functional Description

The ISL8203M's two 3A outputs may be used independently or combined to deliver a single 6A output. Each of the two channels employs the current mode pulse width modulation scheme for fast transient response and pulse-by-pulse current limiting. The two channels each operate at a fixed 1MHz switching frequency, and are 180° out-of-phase, which reduces the input and output noise. The ISL8203M offers internal digital soft-start, external synchronization, overcurrent protection, and over-temperature protection. For further information, please refer to the [ISL8203M datasheet](#).

Quick Start

Dual Output Mode

1. Make sure the placeholder resistors are set for dual output mode according to [Table 1](#) (The ISL8203MEVAL2Z evaluation board is by default set up in dual output mode).
2. Set the ENABLE switches S1 and S2 to "OFF" positions.
3. Select the output voltage for channel 1 by making a selection on jumper J1. Similarly, select the output voltage for channel 2 by making a selection on jumper J2.
4. Connect the positive of a power supply to VIN1 and VIN2 connectors, and the negative of the power supply to one or both of the GND connectors. Make sure the power supply is not enabled when making connections.
5. Turn the power supply on.
6. Turn ENABLE switch S1 to "ON" position to enable channel 1 and switch S2 to "on" position to enable channel 2. Each ENABLE switch can control channel 1 and channel 2 independently.
7. The power-good LED should glow in green if both channel 1 and channel 2 are operating properly. If either one channel is disabled or not operating properly, the LED will glow in red.
8. Measure the channel 1 (or channel 2) output voltage at test points VOUT1 (or VOUT2) test point and adjacent GND test point.

Parallel Single Output Mode

1. Set the placeholder resistors for parallel single output mode according to [Table 1](#).
2. Set the ENABLE switches S1 and S2 to "OFF" positions.
3. Select the output voltage using either one of the jumpers J1 and J2, but do not use both J1 and J2 at the same time.
4. Connect the positive of a power supply to VIN1 and VIN2 connectors, and the negative of the power supply to one or both of the GND connectors. Make sure the power supply is not enabled when making connections.
5. Turn the power supply on.
6. Turn both ENABLE switches S1 and S2 to "on" positions, in any order. Both ENABLE switches need to be in the "on" position in order to enable the output.
7. The power-good LED should glow in green if the output is operating properly. If module is disabled or not operating properly, the LED will glow in red.

8. Measure the output voltage at test points VOUT1 or VOUT2 and GND test point.

Programming the Output Voltage

The ISL8203MEVAL2Z evaluation board has several preset output voltages, 1.0V, 1.2V, 1.5V, 2.5V, and 3.3V, which can be selected in J1 and J2 jumper. To program for other output voltages in the range from 0.8V to 5V, the user can use a feedback resistor divider based on [Equation 1](#).

$$V_{OUT} = \left(1 + \frac{R_{FB-TOP}}{R_{FB-BOTTOM}} \right) \cdot 0.8V \quad (EQ. 1)$$

The top feedback resistor R_{FB-TOP} is typically 100kΩ. In the ISL8203MEVAL2Z evaluation board, the top feedback resistor is R_{12} (for channel 1) and R_{11} (for channel 2).

Setting Parallel Single Output Mode

The ISL8203MEVAL2Z evaluation board is by default set up in dual output mode with two independent outputs, but it can also be easily modified to parallel single output circuit by changing several placeholder resistors. [Table 1](#) shows the placeholder sets to program the default dual output mode and the parallel single output mode.

TABLE 1. PLACEHOLDER SETS TO PROGRAM DUAL OUTPUT MODE AND PARALLEL SINGLE OUTPUT MODE

PLACEHOLDER	DUAL OUTPUT MODE	PARALLEL SINGLE OUTPUT MODE
R ₁₃	Open	0Ω
R ₂₄	0Ω	Open
R ₂₅	0Ω	Open
R ₂₈	Open	0Ω
R ₁₈ , R ₁₉	Open	0Ω (SMD, size 2010) or copper strips

External Synchronization

The frequency of operation can be synchronized up to 4MHz by an external signal applied to the SYNC pin. The switching frequency per channel is half of the external signal's frequency applied to the SYNC pin. The maximum external signal frequency is limited by the SW minimum on time (140ns MAX) requirement, which can be calculated as shown in [Equation 2](#).

$$\frac{1}{2} \cdot f_{SYNC-MAX} = f_{SW-MAX} = \frac{V_{OUT}}{V_{IN}} \cdot \frac{1}{140ns} \quad (EQ. 2)$$

where:

- $f_{SYNC-MAX}$ is the maximum external signal frequency
- f_{SW-MAX} is the maximum switching frequency per channel

Evaluation Board Information

The ISL8203MEVAL2Z evaluation board is a 3X3 in four-layer FR-4 board with 2oz. copper on the top and bottom layers and 1oz. copper on all internal layers. The board can be used as a dual 3A reference design. Refer to "Layout" on [page 6](#). The board is designed with mechanical switches for ENABLE, power-good LED indicators, several connectors, test points, and jumpers, which make testing the board easy.

Thermal Considerations and Current Derating

Board layout is very critical in order to make the module operate safely and deliver maximum allowable power. In order for the board to operate properly in the high ambient temperature environments and carry full load currents, the board layout needs to be carefully designed to maximize thermal performance. To achieve this, select enough trace width, copper weight, and proper connectors.

The ISL8203MEVAL2Z evaluation board is capable of full load current (dual channel 3A or single 6A) at room temperature with plenty of safety margin for junction temperature. However, if the board is to operate at elevated ambient temperatures, then the available output current may need to be derated. Refer to the derated current curves in the [ISL8203M](#) datasheet to determine the maximum output current the evaluation board can supply.

ISL8203MEVAL2Z Schematic

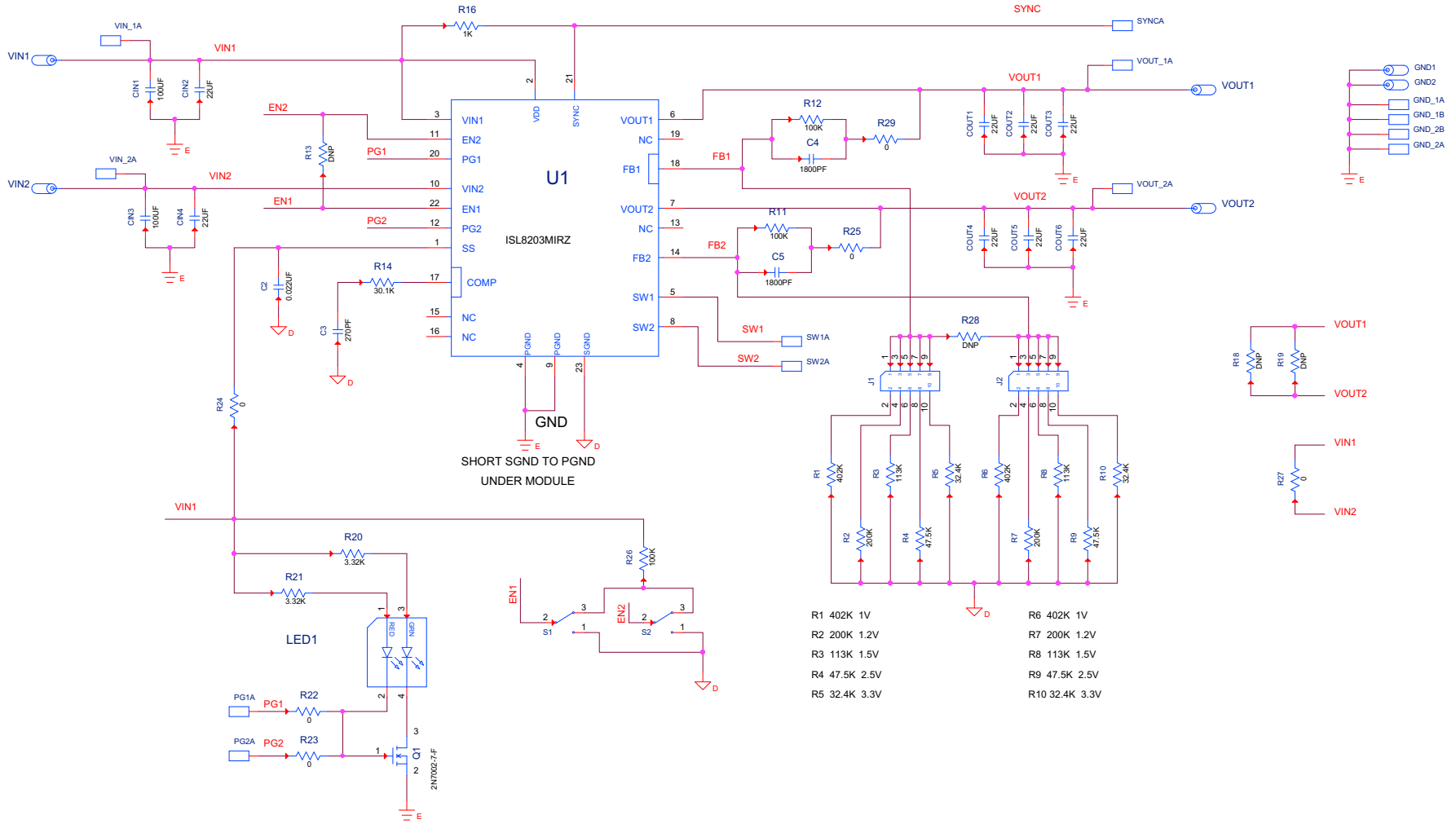

- | | |
|---------------|----------------|
| R1 402K 1V | R6 402K 1V |
| R2 200K 1.2V | R7 200K 1.2V |
| R3 113K 1.5V | R8 113K 1.5V |
| R4 47.5K 2.5V | R9 47.5K 2.5V |
| R5 32.4K 3.3V | R10 32.4K 3.3V |

SHORT SGND TO PGND
UNDER MODULE

Application Note 1941

Bill of Materials

MANUFACTURER'S PART NUMBER	REFERENCE DESIGNATOR	QTY	MANUFACTURER	DESCRIPTION
C0603X7R500-223KNE	C2	1	VENKEL	CAP, SMD, 0603, 0.022 μ F, 50V, 10%, X7R, ROHS
C0603C271J5GACTU	C3	1	KEMET	CAP, SMD, 0603, 270pF, 50V, 5%, C0G, ROHS
GRM39X7R182K050AQ	C4, C5	2	MURATA	CAP, SMD, 0603, 1800pF, 50V, 10%, X7R, ROHS
EMK325ABJ107MM-T	CIN1, CIN3	2	TAIYO YUDEN	CAP, SMD, 1210, 100 μ F, 16V, 20%, X5R, ROHS
GRM31CR61C226KE15L	CIN2, CIN4, COUT1-COUT6	8	MURATA	CAP, SMD, 1206, 22 μ F, 16V, 10%, X5R, ROHS
108-0740-001	GND1, GND2, VIN1, VIN2, VOUT1, VOUT2	6	JOHNSON COMPONENTS	CONN-JACK, BANANA-SS-SDRLESS, VERTICAL, ROHS
67996-272HLF	J1, J2	2	BERG/FCI	CONN-HEADER, 2X5, BRKAWY-2X36, 2.54mm, ROHS
SSL-LXA3025IGC-TR	LED1	1	LUMEX	LED, SMD, 3x2.5mm, 4P, RED/GREEN, 12/20MCD, 2V
2N7002-7-F	Q1	1	DIODES, INC.	TRANSISTOR, N-CHANNEL, 3LD, SOT-23, 60V, 115mA, ROHS
ERJ-3EKF4023V	R1, R6	2	PANASONIC	RES, SMD, 0603, 402k, 1/16W, 1%, TF, ROHS
CRCW0603200KFKEA	R2, R7	2	VISHAY/DALE	RES, SMD, 0603, 200k, 1/10W, 1%, TF, ROHS
MCR03EZPFX1133	R3, R8	2	ROHM	RES, SMD, 0603, 113k, 1/10W, 1%, TF, ROHS
CR0603-10W-4752FT	R4, R9	2	VENKEL	RES, SMD, 0603, 47.5k, 1/10W, 1%, TF, ROHS
ERJ-3EKF3242V	R5, R10	2	PANASONIC	RES, SMD, 0603, 32.4k, 1/10W, 1%, TF, ROHS
CR0603-10W-1003FT	R11, R12, R26	3	VENKEL	RES, SMD, 0603, 100k, 1/10W, 1%, TF, ROHS
	R13, R28	0		RESISTOR, SMD, 0603, 0.1%, MF, DNP-PLACE HOLDER
CR0603-10W-3012FT	R14	1	VENKEL	RES, SMD, 0603, 30.1k, 1/10W, 1%, TF, ROHS
ERJ-3EKF1001V	R16	1	PANASONIC	RES, SMD, 0603, 1k, 1/10W, 1%, TF, ROHS
	R18, R19	0		RES, SMD, 2010, DNP, DNP, DNP, TF, ROHS
RC0603FR-073K32L	R20, R21	2	YAGEO	RES, SMD, 0603, 3.32k, 1/10W, 1%, TF, ROHS
CR0603-10W-000T	R22, R23, R24, R25, R27, R29	6	VENKEL	RES, SMD, 0603, 0 Ω , 1/10W, TF, ROHS
GT13MCBE	S1, S2	2	C&K COMPONENTS	SWITCH-TOGGLE, THRU-HOLE, 5PIN, SPDT, 3POS, ON-OFF-ON, ROHS
ISL8203MIRZ	U1		INTERSIL	IC-6A POWER SUPPLY MODULE, 23P, QFN, ROHS

Board Layout

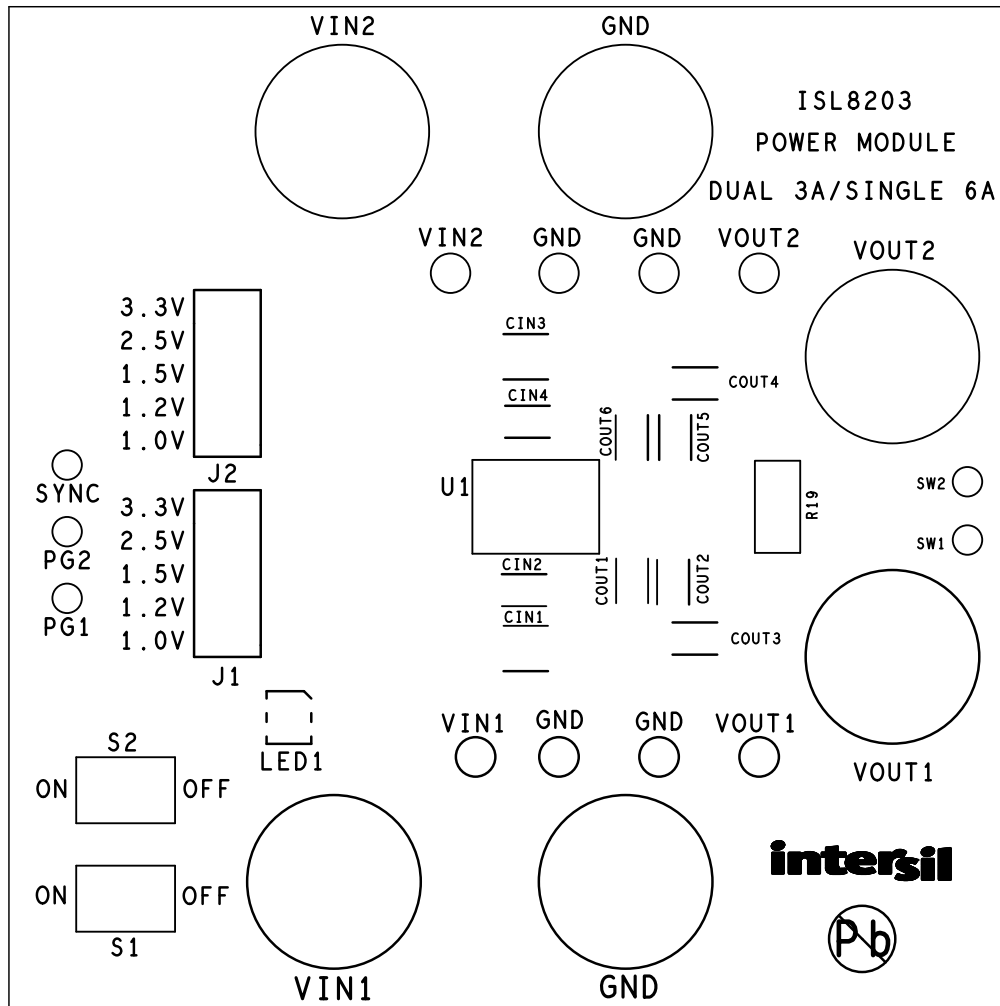

FIGURE 2. SILK SCREEN TOP LAYER

Board Layout

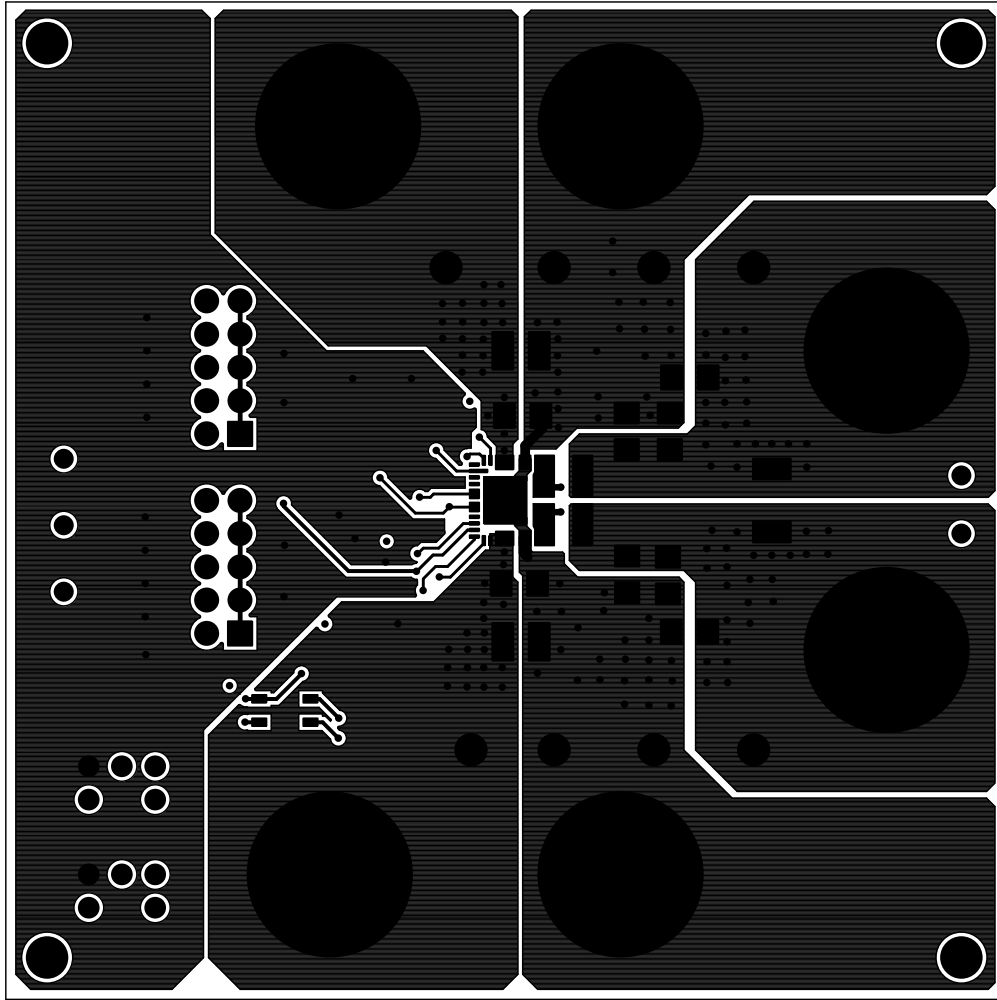

FIGURE 3. TOP LAYER

Board Layout

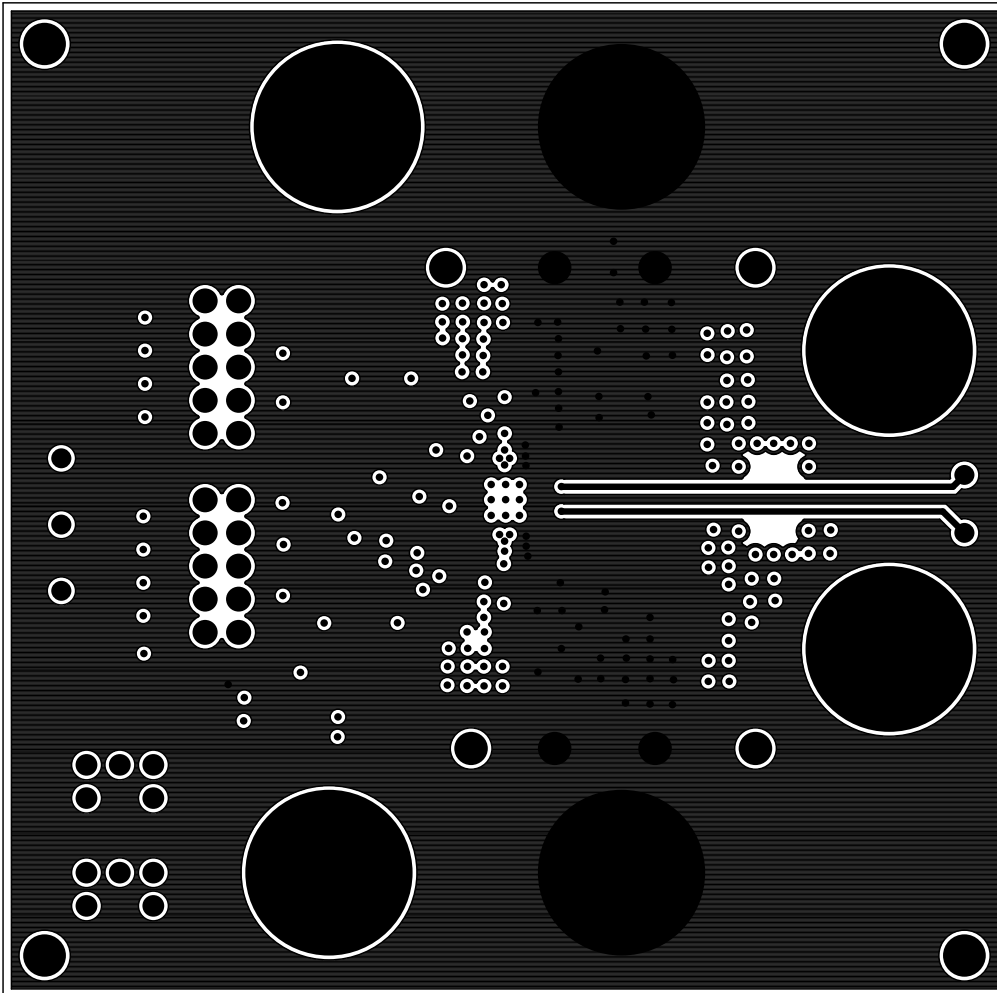

FIGURE 4. LAYER 2

Board Layout

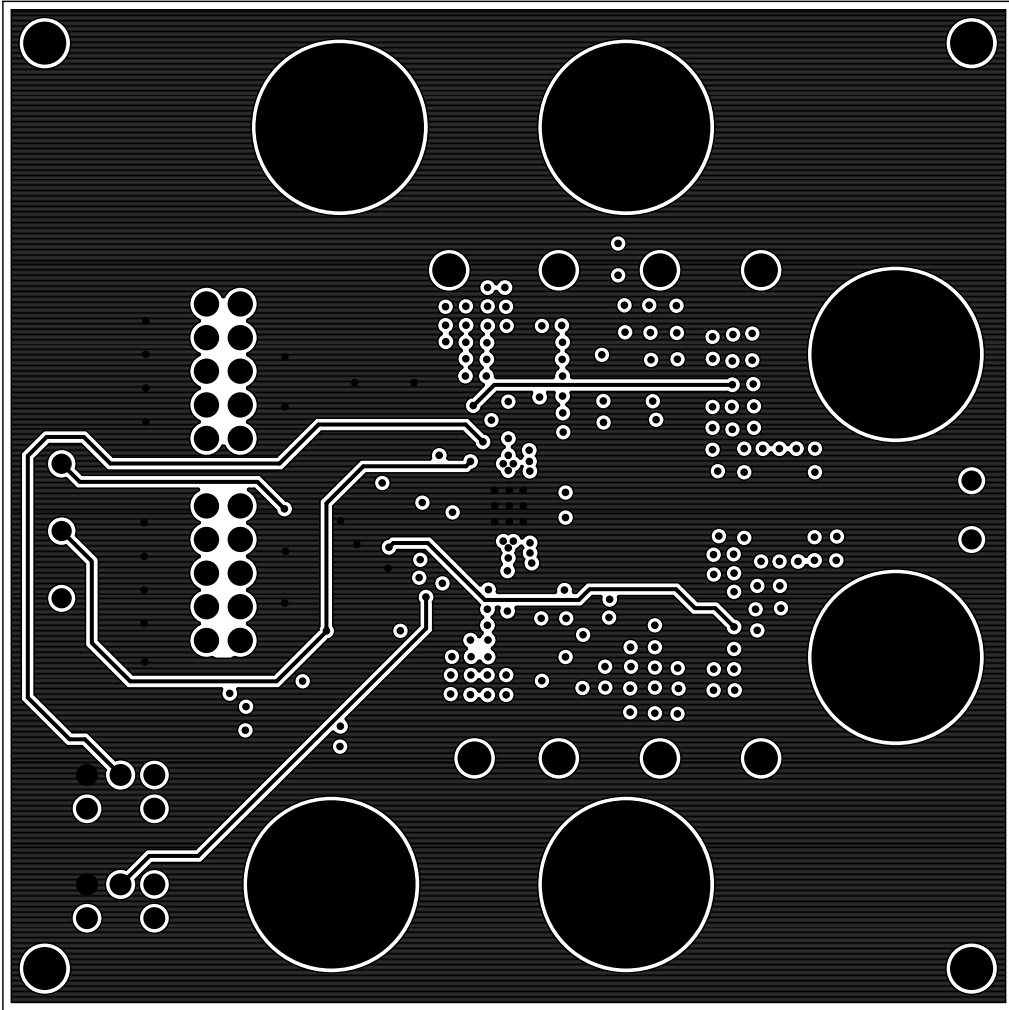

FIGURE 5. LAYER 3

Board Layout

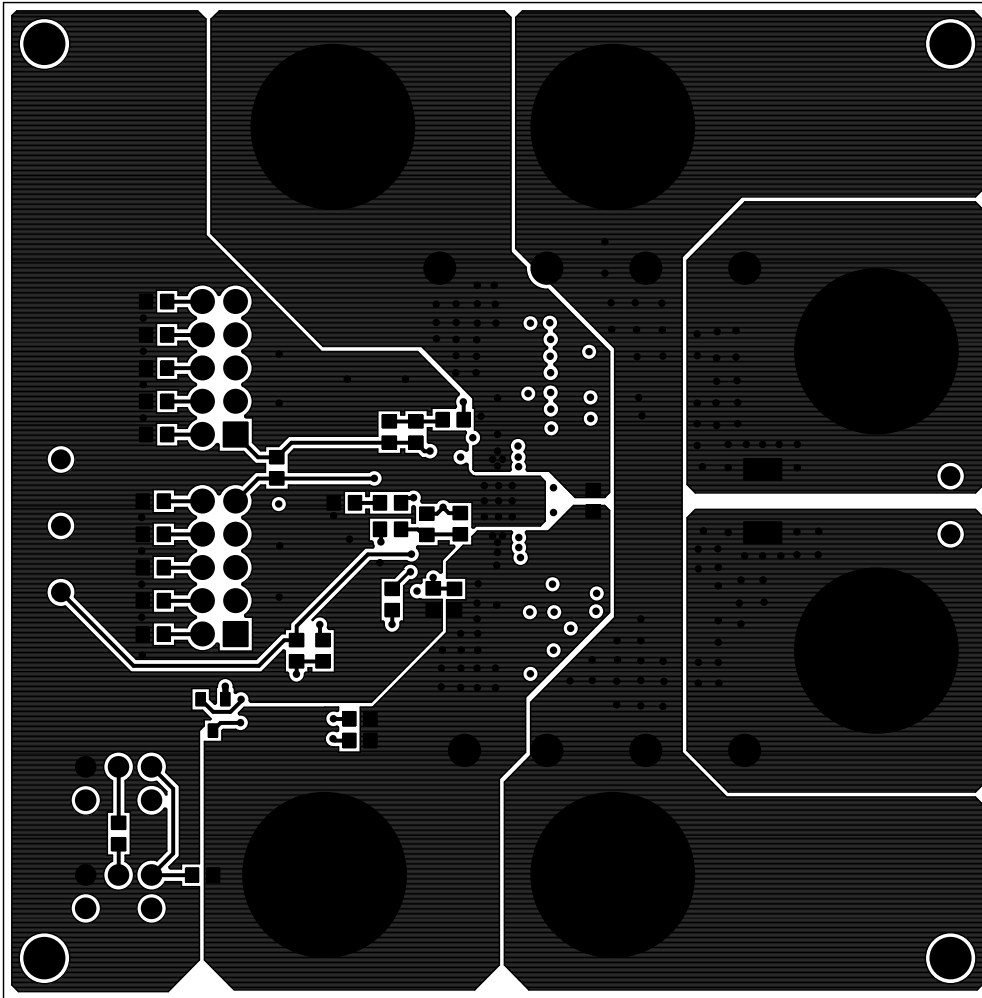

FIGURE 6. BOTTOM LAYER

Board Layout

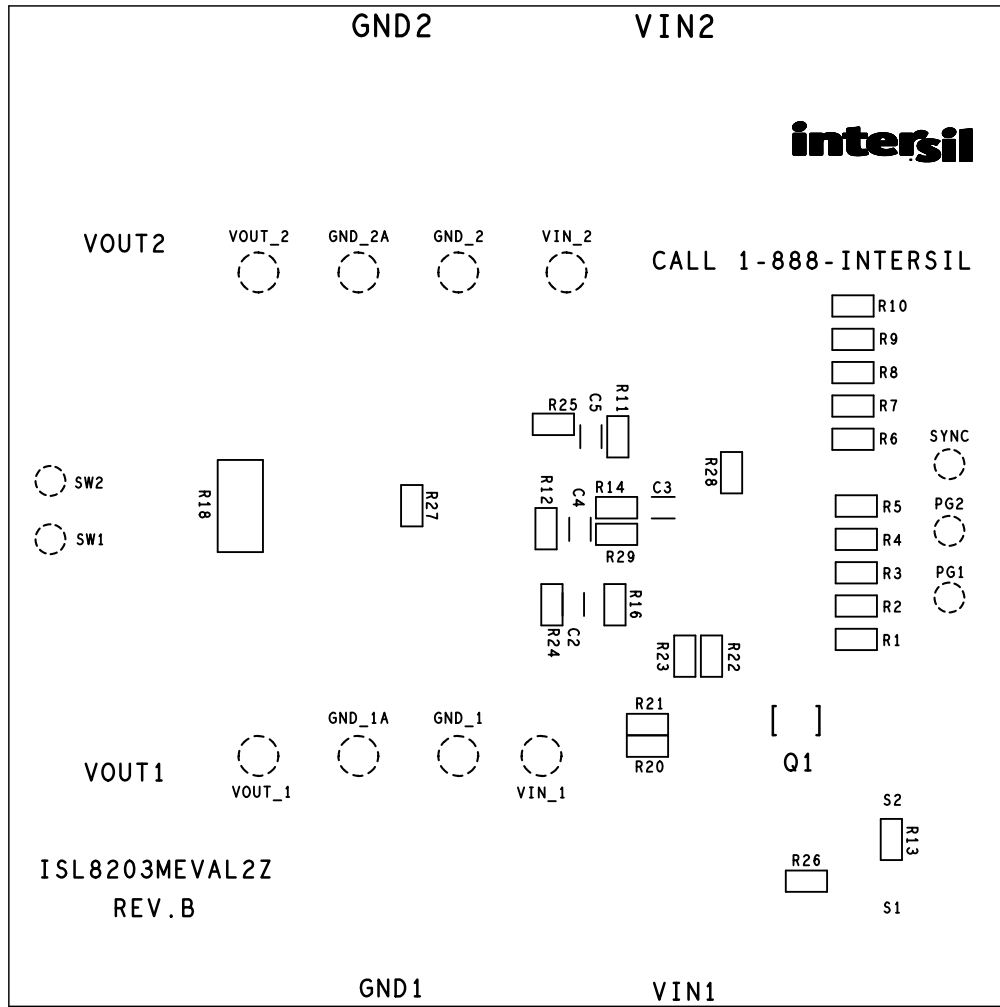

FIGURE 7. SILK SCREEN BOTTOM

ISL8203MEVAL2Z Performance Data

The following data was acquired using a ISL8203MEVAL2Z evaluation board at +25°C ambient and free air OLFM.

The following data was acquired using a ISL8203MEVAL2Z evaluation board at +25°C ambient and free air OLFM.

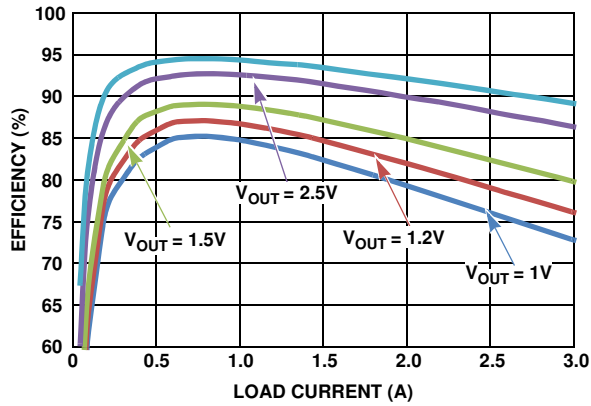

FIGURE 8. EFFICIENCY, SINGLE CHANNEL, $V_{IN} = 5V$

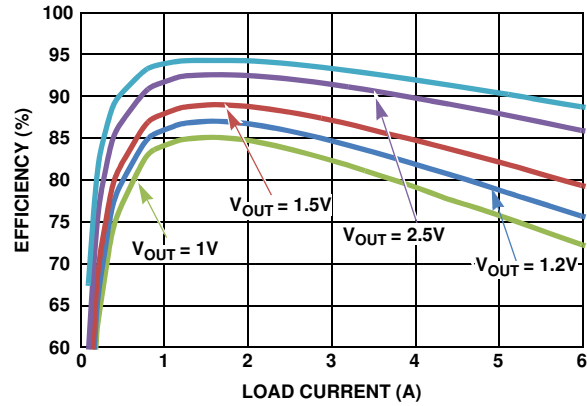

FIGURE 9. EFFICIENCY, PARALLEL SINGLE OUTPUT, $V_{IN} = 5V$

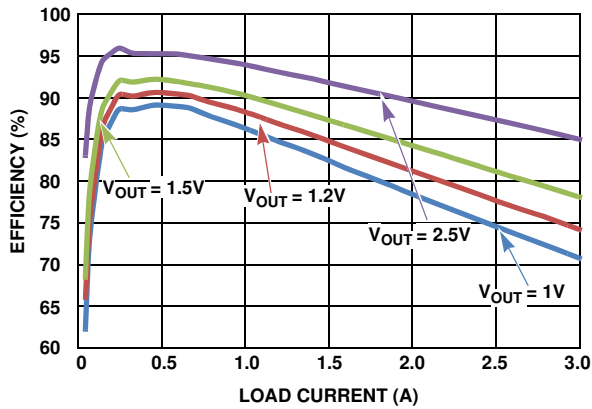

FIGURE 10. EFFICIENCY, SINGLE CHANNEL, $V_{IN} = 3.3V$

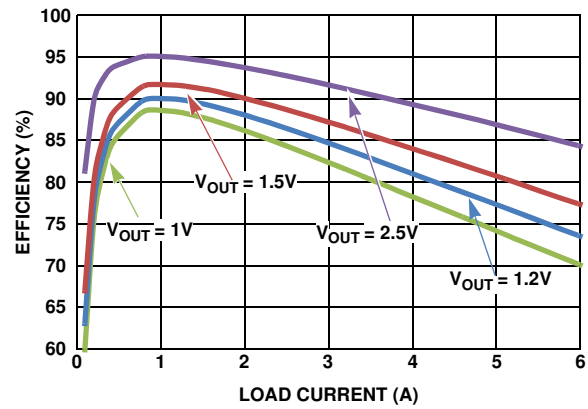

FIGURE 11. EFFICIENCY, PARALLEL SINGLE OUTPUT, $V_{IN} = 3.3V$

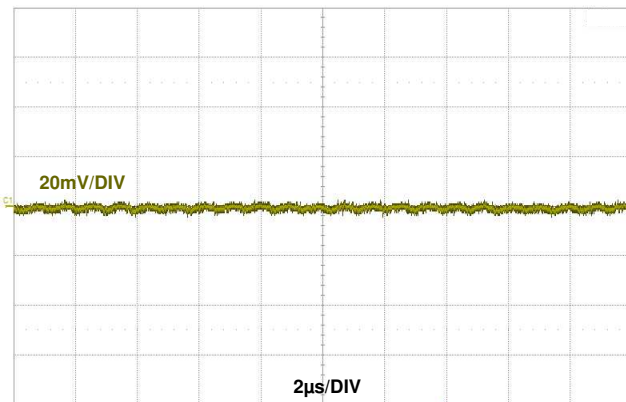

FIGURE 12. OUTPUT VOLTAGE RIPPLE AT $V_{IN} = 5V$, $V_{OUT} = 1.5V$, PARALLEL SINGLE OUTPUT, $I_{OUT} = 6A$, $C_{OUT} = 6 \times 22\mu F$ CERAMIC CAPACITORS

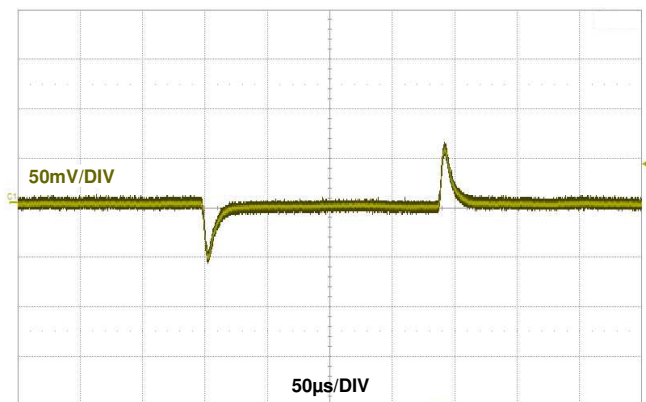

FIGURE 13. LOAD TRANSIENT RESPONSE AT $V_{IN} = 5V$, $V_{OUT} = 1.2V$, PARALLEL SINGLE OUTPUT, 0A TO 3A LOAD STEP, $C_{OUT} = 6 \times 22\mu F$, LOAD CURRENT SLEW RATE: $1A/\mu s$

ISL8203MEVAL2Z Performance Data (Continued)

The following data was acquired using a ISL8203MEVAL2Z evaluation board at +25°C ambient and free air OLFM.

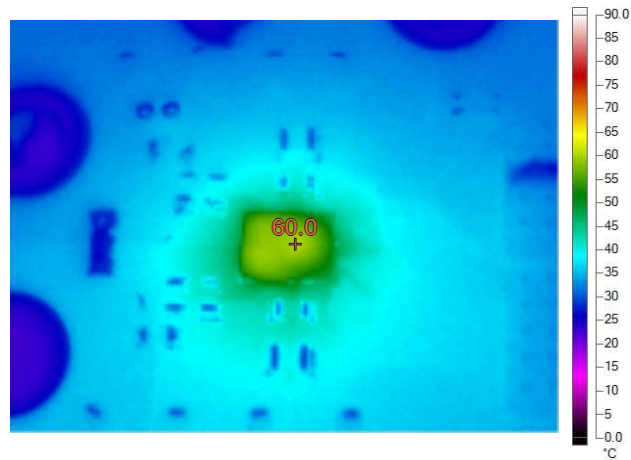

FIGURE 14. THERMAL IMAGE AT $V_{IN} = 5V$, $V_{OUT} = 1.5V$, $I_{OUT} = 6A$, PARALLEL SINGLE OUTPUT, $T_A = +25^\circ C$, FREE AIR OLFM

Intersil Corporation reserves the right to make changes in circuit design, software and/or specifications at any time without notice. Accordingly, the reader is cautioned to verify that the Application Note or Technical Brief is current before proceeding.

For information regarding Intersil Corporation and its products, see www.intersil.com