



Chipsmall Limited consists of a professional team with an average of over 10 year of expertise in the distribution of electronic components. Based in Hongkong, we have already established firm and mutual-benefit business relationships with customers from,Europe,America and south Asia,supplying obsolete and hard-to-find components to meet their specific needs.

With the principle of “Quality Parts,Customers Priority,Honest Operation,and Considerate Service”,our business mainly focus on the distribution of electronic components. Line cards we deal with include Microchip,ALPS,ROHM,Xilinx,Pulse,ON,Everlight and Freescale. Main products comprise IC,Modules,Potentiometer,IC Socket,Relay,Connector.Our parts cover such applications as commercial,industrial, and automotives areas.

We are looking forward to setting up business relationship with you and hope to provide you with the best service and solution. Let us make a better world for our industry!



Contact us

Tel: +86-755-8981 8866 Fax: +86-755-8427 6832

Email & Skype: info@chipsmall.com Web: www.chipsmall.com

Address: A1208, Overseas Decoration Building, #122 Zhenhua RD., Futian, Shenzhen, China



High Input Voltage Charger

The ISL9204 is a cost-effective, fully integrated high input voltage single-cell Li-ion battery charger. This charger performs the CC/CV charge function required by Li-ion batteries. The charger accepts an input voltage up to 28V but is disabled when the input voltage exceeds the OVP threshold, minimum 10V, to prevent excessive power dissipation. The 28V rating eliminates the overvoltage protection circuit required in a low input voltage charger.

The charge current and the end-of-charge (EOC) current are programmable with external resistors. When the battery voltage is lower than a typical value of 2.8V, the charger preconditions the battery with typically 17% of the programmed charge current. When the charge current reduces to the programmable EOC current level during the CV charge phase, an EOC indication is provided by the CHG pin, which is an open-drain output. An internal thermal foldback function protects the charger from any thermal failure.

Two indication pins (PPR and CHG) allow simple interface to a microprocessor or LEDs. When no adapter is attached or when disabled, the charger draws less than 1 μ A leakage current from the battery.

Ordering Information

PART NUMBER	PART MARKING	TEMP. RANGE (°C)	PACKAGE	PKG. DWG. #
ISL9204IRZ-T (Note)	04Z	-40 to 85	8 Ld 2x3 DFN Tape and Reel (Pb-free)	L8.2x3

Intersil Pb-free plus anneal products employ special Pb-free material sets; molding compounds/die attach materials and 100% matte tin plate termination finish, which are RoHS compliant and compatible with both SnPb and Pb-free soldering operations. Intersil Pb-free products are MSL classified at Pb-free peak reflow temperatures that meet or exceed the Pb-free requirements of IPC/JEDEC J STD-020.

Features

- Complete Charger for Single-Cell Li-ion/Polymer Batteries
- Integrated Pass Element and Current Sensor
- No External Blocking Diode Required
- Low Component Count and Cost
- 1% Voltage Accuracy
- Programmable Charge Current
- **Programmable End-of-Charge Current**
- **Charge Current Thermal Foldback for Thermal Protection**
- Trickle Charge for Fully Discharged Batteries
- **28V Maximum Voltage for the Power Input**
- Power Presence and Charge Indications
- Less than 1 μ A Leakage Current Off the Battery when No Input Power Attached or Charger Disabled
- Ambient Temperature Range: -40°C to 85°C
- **2x3 DFN 8 Ld Packages**
- Pb-Free Plus Anneal Available (RoHS Compliant)

Applications

- Mobile Phones
- Blue-Tooth Devices
- PDAs
- MP3 Players
- Stand-alone Chargers
- Other Handheld Devices

Pinout

ISL9204
(8 LD 2x3 DFN)
TOP VIEW

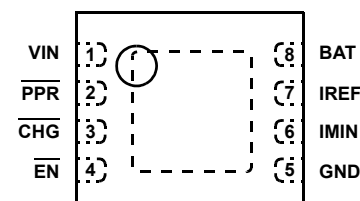

Absolute Maximum Ratings (Reference to GND)

VIN	-0.3V to 30V
IMIN, IREF, BAT, CHG, EN, PPR	-0.3V to 7V

Recommended Operating Conditions

Ambient Temperature Range	-40°C to 85°C
Maximum Supply Voltage (VIN Pin)	28V
Operating Supply Voltage (VIN Pin)	4.3V to 10V
Programmed Charge Current	50mA to 350mA

Thermal Information

Thermal Resistance (Typical, Notes 1, 2)	θ_{JA} (°C/W)	θ_{JC} (°C/W)
DFN Package	59	4.5
Maximum Junction Temperature (Plastic Package)	150°C	
Maximum Storage Temperature Range	-65°C to 150°C	
Maximum Lead Temperature (Soldering 10s)	300°C (SOIC, PLCC, etc. Lead Tips Only)	

CAUTION: Stresses above those listed in "Absolute Maximum Ratings" may cause permanent damage to the device. This is a stress only rating and operation of the device at these or any other conditions above those indicated in the operational sections of this specification is not implied.

NOTES:

- θ_{JA} is measured in free air with the component mounted on a high effective thermal conductivity test board with "direct attach" features. See Tech Brief TB379.
- For theta θ_{JC} the "case temp." location is the center of the exposed metal pad on the package underside.

Electrical Specifications Typical Values Are Tested at VIN = 5V and the Ambient Temperature at 25°C. All Maximum and Minimum Values Are Guaranteed Under the Recommended Operating Supply Voltage Range and Ambient Temperature Range, Unless Otherwise Noted.

PARAMETER	SYMBOL	TEST CONDITIONS	MIN	TYP	MAX	UNITS
POWER-ON RESET						
Rising POR Threshold	V _{POR}	V _{BAT} = 3.0V, use PPR to indicate the comparator output.	3.3	3.9	4.3	V
Falling POR Threshold	V _{POR}		3.1	3.6	4.15	V
VIN-BAT OFFSET VOLTAGE						
Rising Edge	V _{OS}	V _{BAT} = 4.0V, use CHG pin to indicate the comparator output (Note 3)	-	90	150	mV
Falling Edge	V _{OS}		10	50	-	mV
OVER VOLTAGE PROTECTION						
Over Voltage Protection Threshold	V _{OVP}	Use PPR to indicate the comparator output (Note 4)	10	10.5	13	V
OVP Threshold Hysteresis			200	400	500	mV
STANDBY CURRENT						
BAT Pin Sink Current	I _{STANDBY}	Charger disabled or the input is floating	-	-	1.0	μA
VIN Pin Supply Current	I _{VIN}	Charger disabled	-	300	400	μA
VIN Pin Supply Current	I _{VIN}	Charger enabled	-	500	700	μA
VOLTAGE REGULATION						
Output Voltage	V _{CH}	4.3V < V _{IN} < 10V Charge current = 20mA	4.158	4.20	4.242	V
PMOS On Resistance	r _{DS(ON)}	V _{BAT} = 3.8V, charge current = 0.3A	-	0.6	-	Ω
CHARGE CURRENT (Note 5)						
IREF Pin Output Voltage	I _{IREF}	V _{BAT} = 3.8V	1.165	1.210	1.245	V
Constant Charge Current	I _{CHG}	R _{IREF} = 29.4kΩ, V _{BAT} = 2.8V - 4.0V	135	150	165	mA
Trickle Charge Current	I _{TRK}	R _{IREF} = 29.4kΩ, V _{BAT} = 2.4V	18	25	32	mA
End-of-Charge Current	I _{MIN}	R _{IMIN} = 137kΩ	20	30	40	mA
EOC Rising Threshold		R _{IREF} = 29.4kΩ	90	110	130	mA
PRECONDITIONING CHARGE THRESHOLD						
Preconditioning Charge Threshold Voltage	V _{MIN}		2.7	2.8	2.9	V
Preconditioning Voltage Hysteresis	V _{MINHYS}		40	100	150	mV

Electrical Specifications Typical Values Are Tested at VIN = 5V and the Ambient Temperature at 25°C. All Maximum and Minimum Values Are Guaranteed Under the Recommended Operating Supply Voltage Range and Ambient Temperature Range, Unless Otherwise Noted. (Continued)

PARAMETER	SYMBOL	TEST CONDITIONS	MIN	TYP	MAX	UNITS
INTERNAL TEMPERATURE MONITORING						
Charge Current Foldback Threshold (Note 6)	T _{FOLD}		100	115	130	°C
LOGIC INPUT AND OUTPUTS						
EN Pin Logic Input High			1.3	-	-	V
EN Pin Logic Input Low			-	-	0.5	V
EN Pin Internal Pull Down Resistance			100	200	400	kΩ
CHG Sink Current When LOW		Pin Voltage = 1V	10	20	-	mA
CHG Leakage Current When HIGH		V _{CHG} = 6.5V	-	-	1	μA
PPR Sink Current When LOW		Pin Voltage = 1V	10	20	-	mA
PPR Leakage Current When HIGH		V _{PPR} = 6.5V	-	-	1	μA

NOTES:

- The 4.0V V_{BAT} is selected so that the CHG output can be used as the indication for the offset comparator output indication. If the V_{BAT} is lower than the POR threshold, no output pin can be used for indication.
- For junction temperature from -40°C to 120°C.
- The charge current can be affected by the thermal foldback function if the IC under the test setup cannot dissipate the heat.
- Guaranteed by characterization or correlation to other test.

Typical Characteristics

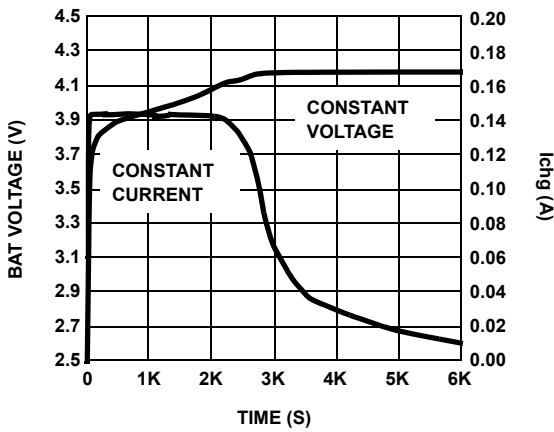

FIGURE 1. COMPLETE CHARGE CYCLE (130mAh BATTERY)

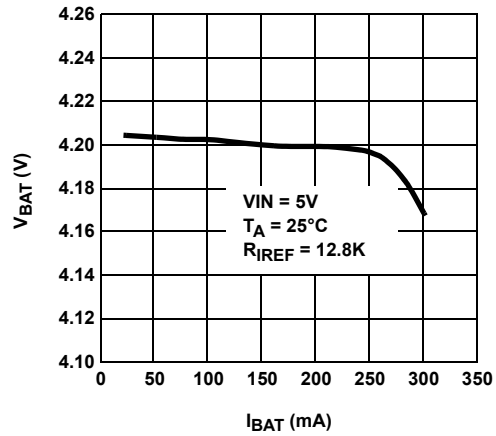

FIGURE 2. CONSTANT VOLTAGE vs CHARGE CURRENT

Typical Characteristics (Continued)

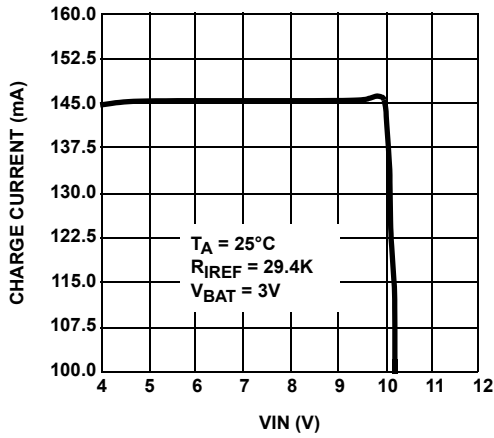

FIGURE 3. CHARGE CURRENT vs VIN

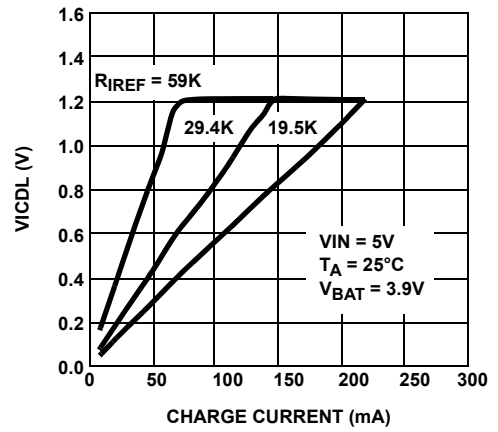

FIGURE 4. VICDL vs CHARGE CURRENT

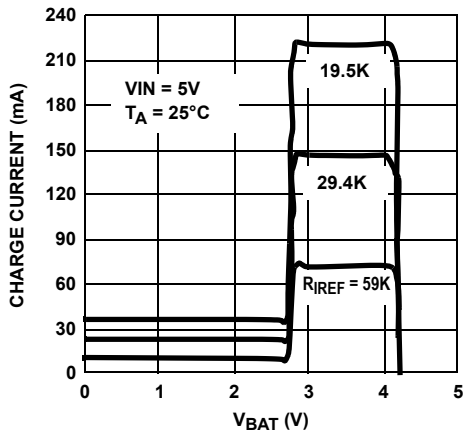

FIGURE 5. CHARGE CURRENT vs V_{BAT}

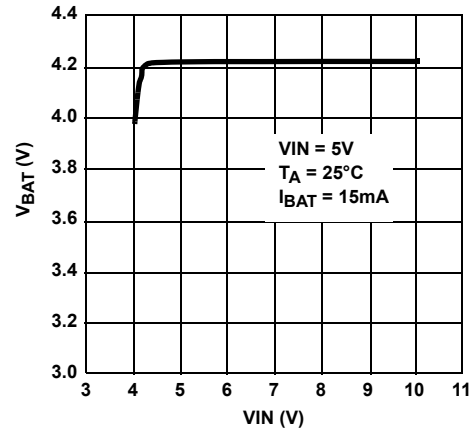

FIGURE 6. V_{BAT} vs VIN

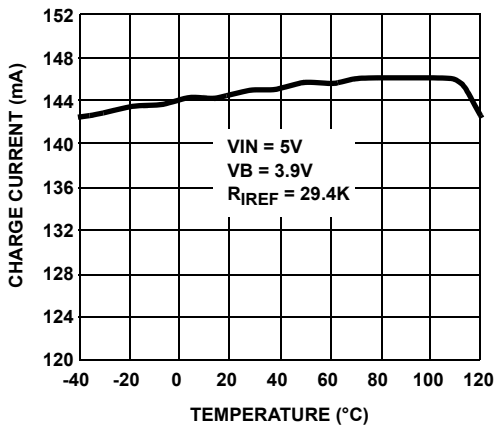

FIGURE 7. CHARGE CURRENT vs TEMPERATURE

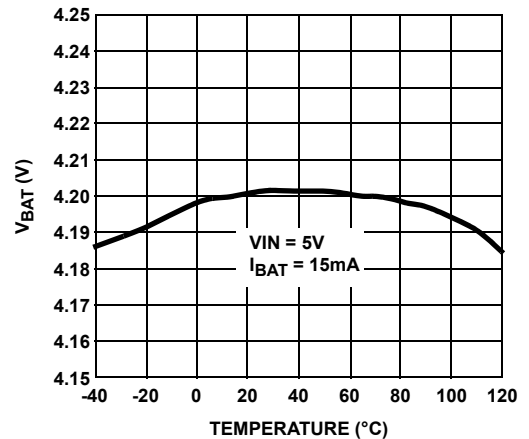

FIGURE 8. V_{BAT} vs TEMPERATURE

Pin Descriptions

VIN - Power input. The absolute maximum input voltage is 28V. A 0.47µF or larger value X5R ceramic capacitor is recommended to be placed very close to the input pin for decoupling purpose. Additional capacitance may be required to provide a stable input voltage.

PPR - Open-drain power presence indication. The open-drain MOSFET turns on when the input voltage is above the POR threshold but below the OVP threshold and off otherwise. This pin is capable to sink 10mA (minimum) current to drive a LED. The maximum voltage rating for this pin is 7V. This pin is independent on the EN-pin input.

CHG - Open-drain charge indication pin. This pin outputs a logic LOW when a charge cycle starts and turns to HIGH when the end-of-charge (EOC) condition is qualified. This pin is capable to sink 10mA min. current to drive an LED. When the charger is disabled, the CHG outputs high impedance.

EN - Enable input. This is a logic input pin to disable or enable the charger. Drive to HIGH to disable the charger. When this pin is driven to LOW or left floating, the charger is enabled. This pin has an internal 200kΩ pull-down resistor.

GND - System ground.

IMIN - End-of-charge (EOC) current program pin. Connect a resistor between this pin and the GND pin to set the EOC

current. The EOC current I_{MIN} can be programmed by the following equation:

$$I_{MIN} = \frac{4180}{R_{IMIN}} \quad (\text{mA})$$

Where R_{IMIN} is in kΩ. The programmable range covers 5% (or 10mA, whichever is higher) to 50% of I_{REF} . When programmed to less than 5% or 10mA, the stability is not guaranteed.

IREF - Charge-current program and monitoring pin. Connect a resistor between this pin and the GND pin to set the charge current limit determined by the following equation:

$$I_{REF} = \frac{4400}{R_{IREF}} \quad (\text{mA})$$

Where R_{IREF} is in kΩ. The IREF pin voltage also monitors the actual charge current during the entire charge cycle, including the trickle, constant-current, and constant-voltage phases. When disabled, $V_{IREF} = 0V$.

BAT - Charger output pin. Connect this pin to the battery. A 1µF or larger X5R ceramic capacitor is recommended for decoupling and stability purposes. When the EN pin is pulled to logic HIGH, the BAT output is disabled.

EPAD - Exposed pad. Connect as much as possible copper to this pad either on the component layer or other layers through thermal vias to enhance the thermal performance.

Typical Application

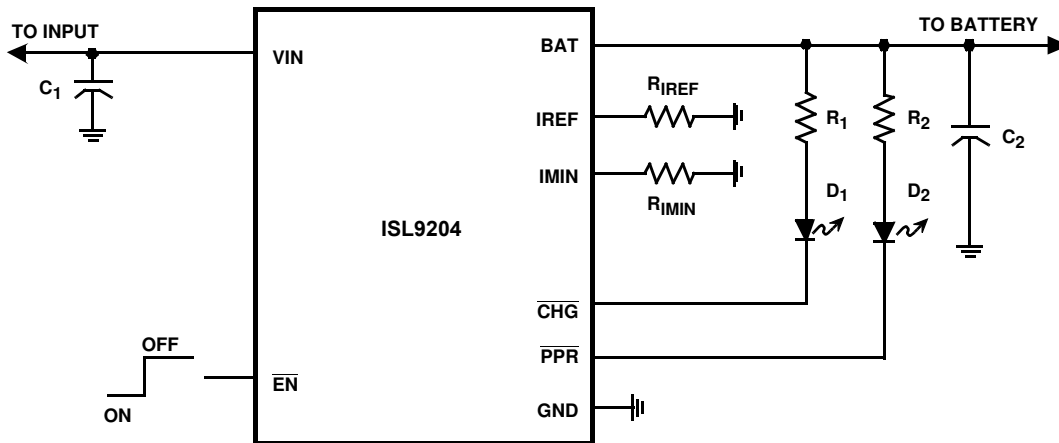

FIGURE 9. TYPICAL APPLICATION CIRCUIT INTERFACING TO INDICATION LEADS

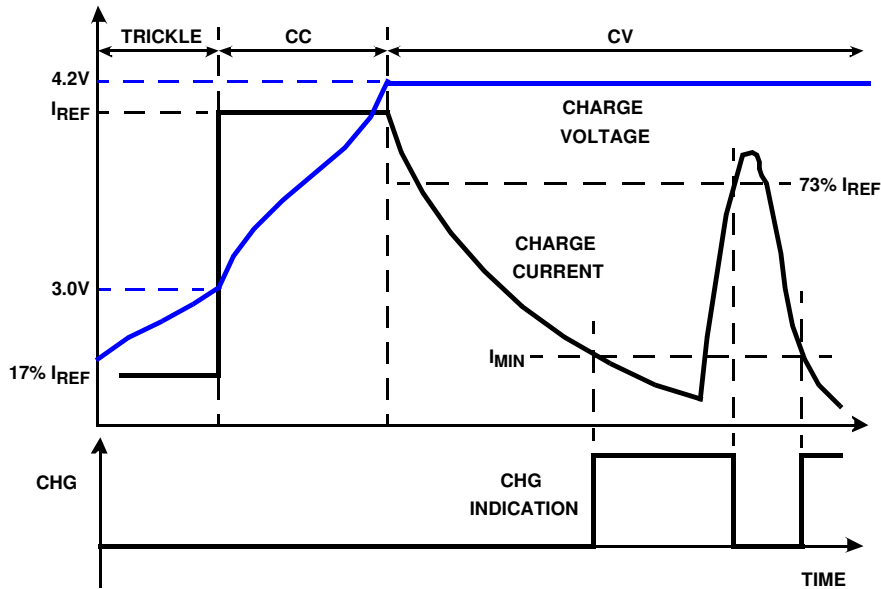

FIGURE 12. TYPICAL CHARGE PROFILE

Description

The ISL9204 charges a Li-ion battery with a constant current (CC) or a constant voltage (CV). The constant current I_{REF} is set with the external resistor R_{IREF} (see Figure 9) and the constant voltage is fixed at 4.2V. If the battery voltage is below a typical 2.8V trickle-charge threshold, the ISL9204 charges the battery with a trickle current until the battery voltage rises above the trickle charge threshold. When the battery voltage reaches 4.2V, the charger enters a CV mode and regulates the battery voltage at 4.2V to fully charge the battery without the risk of over charge. Upon reaching an end-of-charge (EOC) current, the charger indicates the charge completion with the CHG pin, but the charger continues to output the 4.2V voltage. Figure 12 shows the typical charge profile and the EOC/reset event.

The EOC current level I_{MIN} is programmable with the external resistor R_{IMIN} (see Figure 9). The CHG signal turns to LOW when the trickle charge starts and rises to HIGH at the EOC. After the EOC is reached, the charge current has to rise to typically 73% I_{REF} for the CHG signal to turn on again, as shown in Figure 12. The current surge after EOC can be caused by a load connected to the battery.

A thermal foldback function reduces the charge current anytime when the die temperature reaches typically 115°C. This function guarantees safe operation when the printed-circuit board (PCB) is not capable of dissipating the heat generated by the linear charger. The ISL9204 accepts an input voltage up to 28V but disables charging when the input voltage exceeds the OVP threshold, minimum 10V, to protect against unqualified or faulty AC adapters.

PPR Indication

The PPR pin is an open-drain output to indicate the presence of the AC adapter. Whenever the input voltage is

higher than the POR threshold, the PPR pin turns on the internal open-drain MOSFET to indicate a logic LOW signal, independent on the EN-pin input. When the internal open-drain FET is turned off, the PPR pin should leak less than 1μA current. When turned on, the PPR pin should be able to sink at least 10mA current under all operating conditions.

The PPR pin can be used to drive an LED (see Figure 9) or to interface with a microprocessor.

Power-Good Range

The power-good range is defined by the following three conditions:

1. $V_{IN} > V_{POR}$
2. $V_{IN} - V_{BAT} > V_{OS}$
3. $V_{IN} < V_{OVP}$

where the V_{OS} is the offset voltage for the input and output voltage comparator, discussed shortly, and the V_{OVP} is the overvoltage protection threshold given in the Electrical Specification. All V_{POR} , V_{OS} , and V_{OVP} have hysteresis, as given in the Electrical Specification table. The charger will not charge the battery if the input voltage is not in the power-good range.

Input and Output Comparator

The charger will not be enabled unless the input voltage is higher than the battery voltage by an offset voltage V_{OS} . The purpose of this comparator is to ensure that the charger is turned off when the input power is removed from the charger. Without this comparator, it is possible that the charger will fail to power down when the input is removed and the current can leak through the PFET pass element to continue biasing the POR and the Pre-Regulator blocks shown in the Block Diagram.

CHG Indication

The CHG is an open-drain output capable to at least 10mA current when the charger starts to charge and turns off when the EOC current is reached. The CHG signal is interfaced either with a micro-processor GPIO or an LED for indication.

EN Input

EN is an active-low logic input to enable the charger. Drive the EN pin to LOW or leave it floating to enable the charger. This pin has a 200k Ω internal pulldown resistor so when left floating, the input is equivalent to logic LOW. Drive this pin to HIGH to disable the charger. The threshold for HIGH is given in the ES (Electrical Specification) table.

IREF Pin

The IREF pin has the two functions as described in the Pin Description section. When setting the fast charge current, the charge current is guaranteed to have 10% accuracy with the charge current set at 150mA. When monitoring the charge current, the accuracy of the IREF pin voltage vs. the actual charge current has the same accuracy as the gain from the IREF pin current to the actual charge current. The accuracy is 10% at 150mA and is expected to drop to 30% of the actual current (not the set constant charge current) when the current drops to 50mA.

Operation Without the Battery

The ISL9204 relies on a battery for stability and is not guaranteed to be stable if the battery is not connected. With a battery, the charger will be stable with an output ceramic decoupling capacitor in the range of 1 μ F to 200 μ F. The maximum load current is limited by the dropout voltage or the thermal foldback.

Dropout Voltage

The constant current may not be maintained due to the $r_{DS(ON)}$ limit at a low input voltage. The worst case on resistance of the pass FET is 1.2 Ω the maximum operating temperature, thus if tested with 350mA current and 4.2V battery voltage, constant current could not be maintained when the input voltage is below 4.62V.

Thermal Foldback

The thermal foldback function starts to reduce the charge current when the internal temperature reaches a typical value of 115°C.

Applications Information**Input Capacitor Selection**

The input capacitor is required to suppress the power supply transient response during transitions. Mainly this capacitor is selected to avoid oscillation during the start up when the input supply is passing the POR threshold and the VIN-BAT comparator offset voltage. When the battery voltage is above the POR threshold, the VIN-VBAT offset voltage dominates the hysteresis value. Typically, a 1 μ F X5R ceramic capacitor should be sufficient to suppress the power supply noise.

Output Capacitor Selection

The criteria for selecting the output capacitor is to maintain the stability of the charger as well as to bypass any transient load current. The minimum capacitance is a 1 μ F X5R ceramic capacitor. The actual capacitance connected to the output is dependent on the actual application requirement.

Charge Current Limit

The actual charge current in the CC mode is limited by several factors in addition to the set I_{REF} . Figure 13 shows three limits for the charge current in the CC mode. The charge current is limited by the on resistance of the pass element (power P-channel MOSFET) if the input and the output voltage are too close to each other. The solid curve shows a typical case when the battery voltage is 4.0V and the charge current is set to 350mA. The non-linearity on the R_{ON} -limited region is due to the increased resistance at higher die temperature. If the battery voltage increases to higher than 4.0V, the entire curve moves towards right side. As the input voltage increases, the charge current may be reduced due to the thermal foldback function. The limit caused by the thermal limit is dependent on the thermal impedance. As the thermal impedance increases, the thermal-limited curve moves towards left, as shown in Figure 13.

Layout Guidance

The ISL9204 uses a thermally-enhanced DFN package that has an exposed thermal pad at the bottom side of the package. The layout should connect as much as possible to copper on the exposed pad. Typically the component layer is more effective in dissipating heat. The thermal impedance can be further reduced by using other layers of copper connecting to the exposed pad through a thermal via array. Each thermal via is recommended to have 0.3mm diameter and 1mm distance from other thermal vias.

Input Power Sources

The input power source is typically a well-regulated wall cube with 1-meter length wire or a USB port. The input voltage ranges from 4.3V to 10V. The ISL9204 can withstand up to 28V on the input without damaging the IC. If the input voltage is higher than the OVP threshold, the charger stops charging.

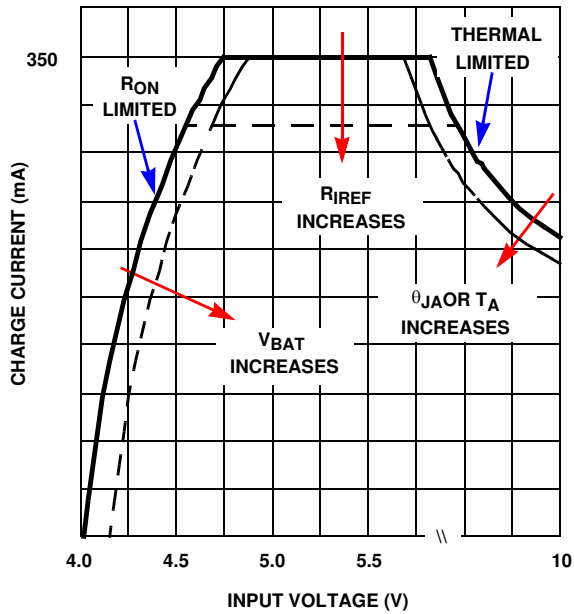
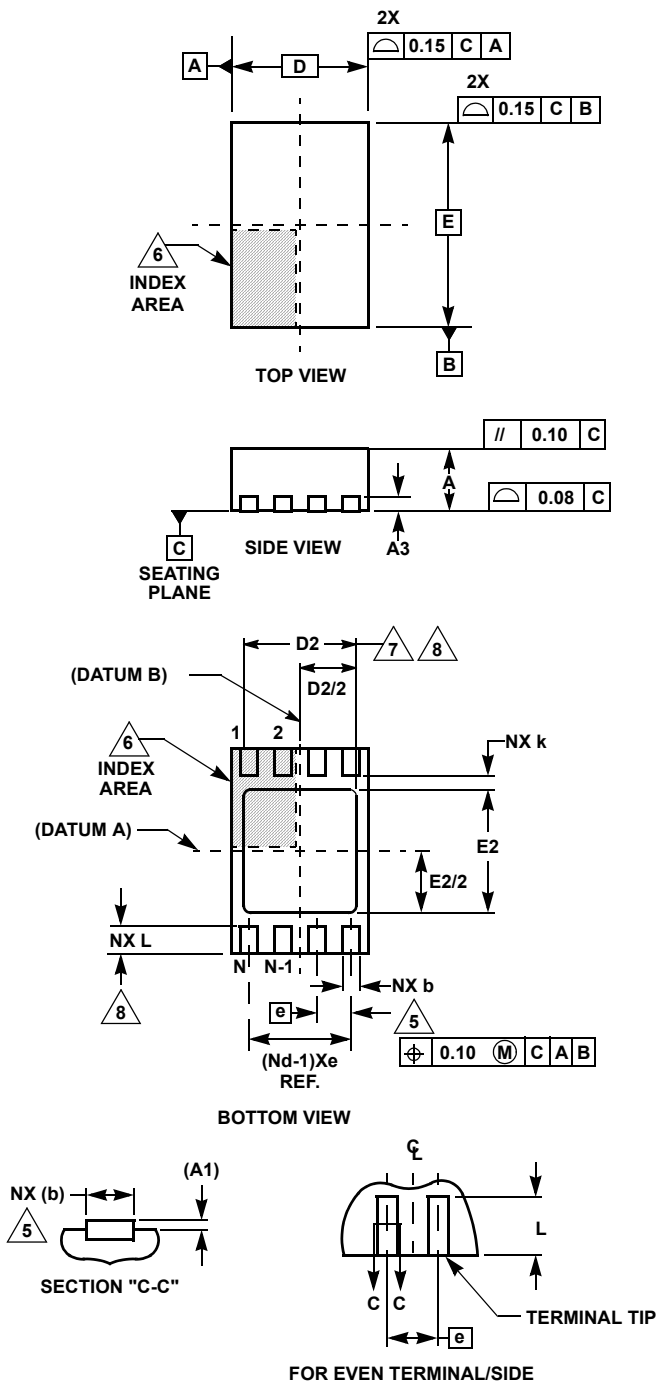

FIGURE 13. CHARGE CURRENT LIMITS IN CONSTANT CURRENT MODE

Dual Flat No-Lead Plastic Package (DFN)



L8.2x3

8 LEAD DUAL FLAT NO-LEAD PLASTIC PACKAGE

SYMBOL	MILLIMETERS			NOTES
	MIN	NOMINAL	MAX	
A	0.80	0.90	1.00	-
A1	-	-	0.05	-
A3	0.20 REF			-
b	0.20	0.25	0.32	5,8
D	2.00 BSC			-
D2	1.50	1.65	1.75	7,8
E	3.00 BSC			-
E2	1.65	1.80	1.90	7,8
e	0.50 BSC			-
k	0.20	-	-	-
L	0.30	0.40	0.50	8
N	8			2
Nd	4			3

Rev. 0 6/04

NOTES:

1. Dimensioning and tolerancing conform to ASME Y14.5-1994.
2. N is the number of terminals.
3. Nd refers to the number of terminals on D.
4. All dimensions are in millimeters. Angles are in degrees.
5. Dimension b applies to the metallized terminal and is measured between 0.25mm and 0.30mm from the terminal tip.
6. The configuration of the pin #1 identifier is optional, but must be located within the zone indicated. The pin #1 identifier may be either a mold or mark feature.
7. Dimensions D2 and E2 are for the exposed pads which provide improved electrical and thermal performance.
8. Nominal dimensions are provided to assist with PCB Land Pattern Design efforts, see Intersil Technical Brief TB389.

All Intersil U.S. products are manufactured, assembled and tested utilizing ISO9000 quality systems. Intersil Corporation's quality certifications can be viewed at www.intersil.com/design/quality

Intersil products are sold by description only. Intersil Corporation reserves the right to make changes in circuit design, software and/or specifications at any time without notice. Accordingly, the reader is cautioned to verify that data sheets are current before placing orders. Information furnished by Intersil is believed to be accurate and reliable. However, no responsibility is assumed by Intersil or its subsidiaries for its use; nor for any infringements of patents or other rights of third parties which may result from its use. No license is granted by implication or otherwise under any patent or patent rights of Intersil or its subsidiaries.

For information regarding Intersil Corporation and its products, see www.intersil.com