



Chipsmall Limited consists of a professional team with an average of over 10 year of expertise in the distribution of electronic components. Based in Hongkong, we have already established firm and mutual-benefit business relationships with customers from,Europe,America and south Asia,supplying obsolete and hard-to-find components to meet their specific needs.

With the principle of "Quality Parts,Customers Priority,Honest Operation,and Considerate Service",our business mainly focus on the distribution of electronic components. Line cards we deal with include Microchip,ALPS,ROHM,Xilinx,Pulse,ON,Everlight and Freescale. Main products comprise IC,Modules,Potentiometer,IC Socket,Relay,Connector.Our parts cover such applications as commercial,industrial, and automotives areas.

We are looking forward to setting up business relationship with you and hope to provide you with the best service and solution. Let us make a better world for our industry!



## Contact us

Tel: +86-755-8981 8866 Fax: +86-755-8427 6832

Email & Skype: info@chipsmall.com Web: www.chipsmall.com

Address: A1208, Overseas Decoration Building, #122 Zhenhua RD., Futian, Shenzhen, China





# Technical Data Sheet

## Opto Interrupter

### ITR8402-F-A

#### ■ Features

- Fast response time
- High analytic
- Cut-off visible wavelength  $\lambda_p=940\text{nm}$
- High sensitivity
- Pb free
- This product itself will remain within RoHS compliant version.

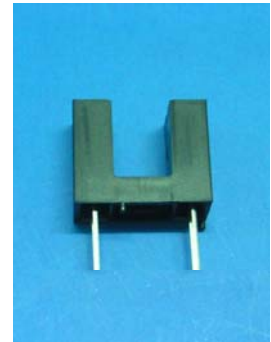

#### ■ Descriptions

The **ITR8402-F-A** consist of an infrared emitting diode and an NPN silicon phototransistor, encased side-by-side on converging optical axis in a black thermoplastic housing .

The phototransistor receives radiation from the IRED only .This is the normal situation. But when an object is in between , phototransistor could not receives the radiation.

For additional component information , please refer to IR908-7C-F and PT908-7C-F

#### ■ Applications

- Mouse Copier
- Switch Scanner
- Floppy disk driver
- Non-contact Switching
- For Direct Board

#### ■ Device Selection Guide

Device No.	Chip Material	LENS COLOR
IR908-7C-F	GaAlAs	Water clear
PT908-7C-F	Silicon	Water clear

**Package Dimensions**

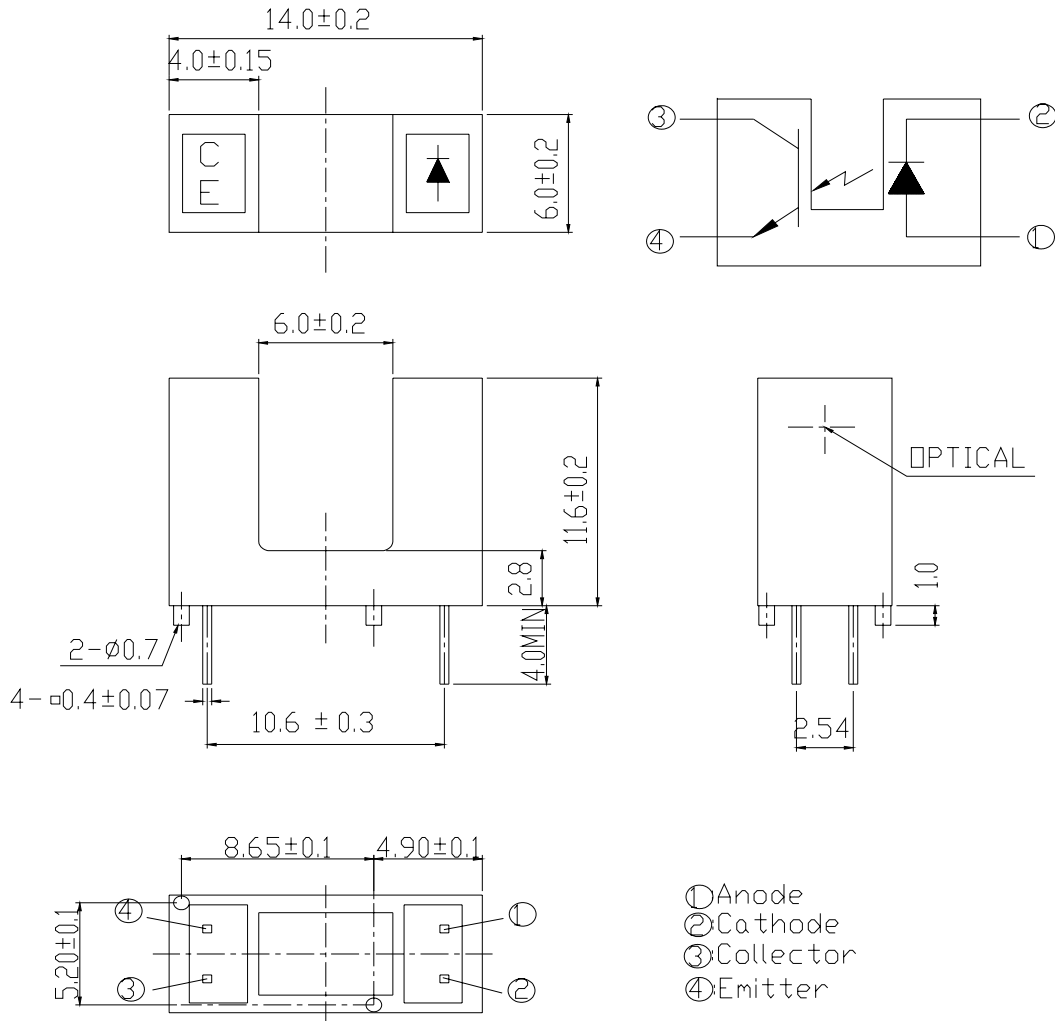

**Notes:**

1. All dimensions are in millimeters
2. Tolerances unless dimensions  $\pm 0.2$  mm

**Absolute Maximum Ratings (Ta=25°C)**

Parameter		Symbol	Ratings	Unit
Input	Power Dissipation at(or below) 25°C Free Air Temperature	P <sub>D</sub>	75	mW
	Reverse Voltage	V <sub>R</sub>	5	V
	Forward Current	I <sub>F</sub>	50	mA
	Peak Forward Current (*1) Pulse width ≤ 100 μs, Duty cycle=1%	I <sub>FP</sub>	1	A
	Collector Power Dissipation	P <sub>C</sub>	75	mW
Output	Collector Current	I <sub>C</sub>	20	mA
	Collector-Emitter Voltage	B V <sub>CEO</sub>	30	V
	Emitter-Collector Voltage	B V <sub>ECO</sub>	5	V
	Operating Temperature	T <sub>opr</sub>	-25~+85	°C
Storage Temperature	T <sub>stg</sub>	-40~+100	°C	
Lead Soldering Temperature (*2) (1/16 inch form body for 5 seconds)	T <sub>sol</sub>	260	°C	

(\*1)  $t_w=100 \mu\text{sec.}$ ,  $T=10\text{msec.}$  (\*2)  $t=5\text{Sec}$

**Electro-Optical Characteristics (Ta=25°C)**

Parameter		Symbol	Min.	Typ.	Max.	Unit	Conditions
Input	Forward Voltage	V <sub>FI</sub>	---	1.2	1.5	V	I <sub>F</sub> =20mA
	Reverse Current	I <sub>R</sub>	---	---	10	μA	V <sub>R</sub> =5V
	Peak Wavelength	λ <sub>p</sub>	---	940	---	nm	I <sub>F</sub> =20mA
	View Angle	2θ <sub>1/2</sub>	---	40	---	Deg	I <sub>F</sub> =20mA
Output	Dark Current	I <sub>CEO</sub>	---	---	100	nA	V <sub>CE</sub> =20V, Ee=0mW/cm <sup>2</sup>
	C-E Saturation Voltage	V <sub>CE(sat)</sub>	---	---	0.4	V	I <sub>C</sub> =2mA, Ee=1mW/cm <sup>2</sup>
Transfer Characteristics	Collect Current	I <sub>C(ON)</sub>	0.5	---	---	mA	V <sub>CE</sub> =5V I <sub>F</sub> =20mA
		I <sub>C(OFF)</sub>	---	---	20	μA	
	Rise time	t <sub>r</sub>	---	15	---	μsec	V <sub>CE</sub> =5V I <sub>C</sub> =1mA, R <sub>L</sub> =1KΩ
	Fall time	t <sub>f</sub>	---	15	---	μsec	

**Typical Electrical/Optical/Characteristics Curves for IR**

Fig.1 Forward Current vs.

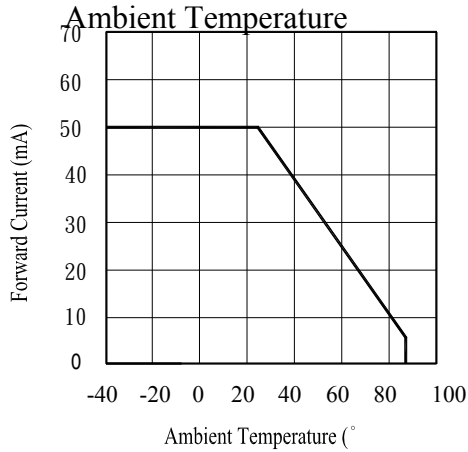

Fig.2 Spectral Distribution

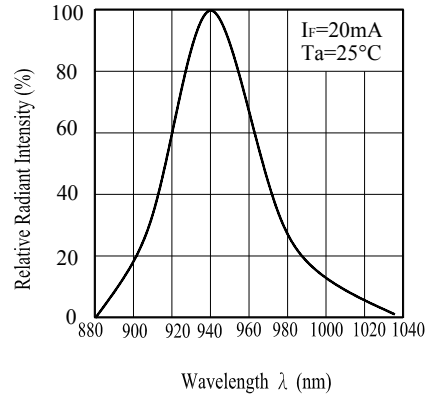

Fig.5 Relative Intensity vs.

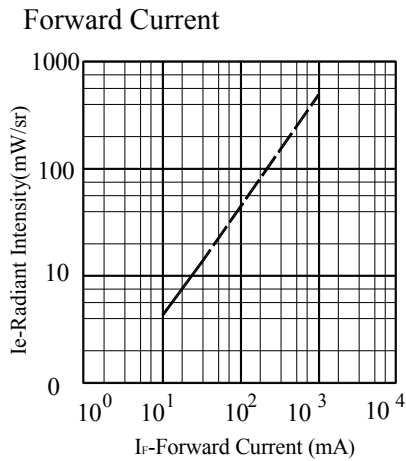

Fig.6 Relative Radiant Intensity vs.

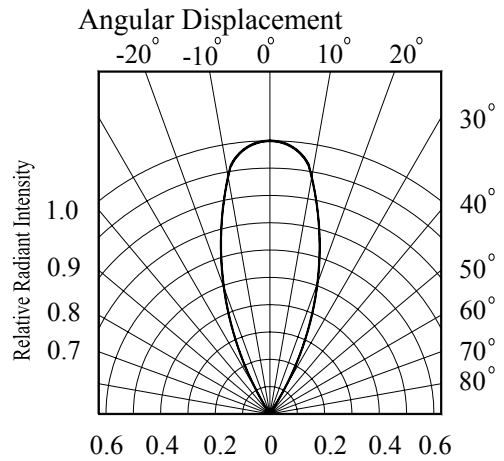

Fig.7 Relative Intensity vs.

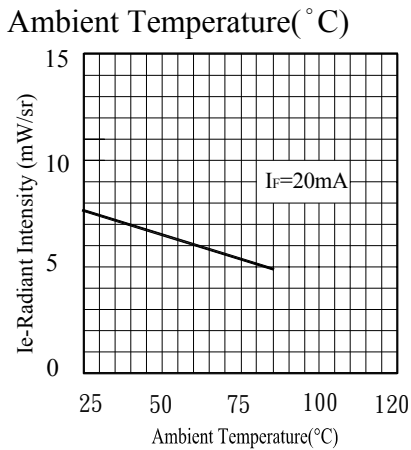
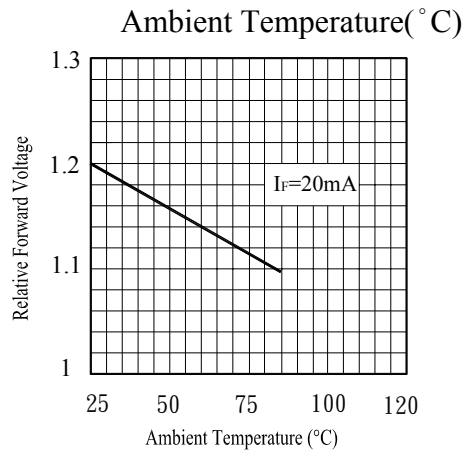

Fig.8 Forward Current vs.



**Typical Electrical/Optical/Characteristics Curves for PT**

Fig.1 Collector Power Dissipation vs. Ambient Temperature

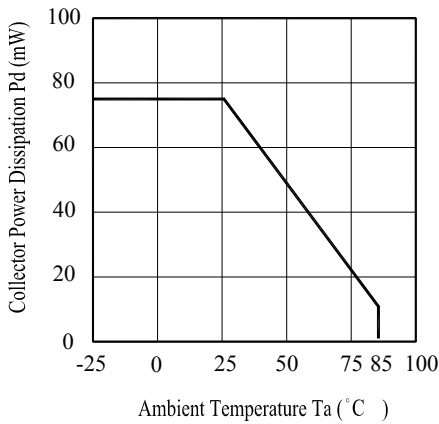

Fig.2 Spectral Sensitivity

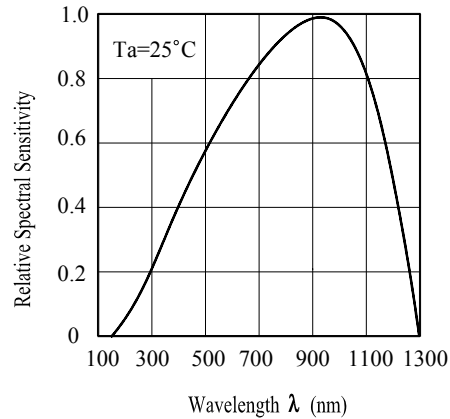

Fig.3 Relative Collector Current vs. Ambient Temperature

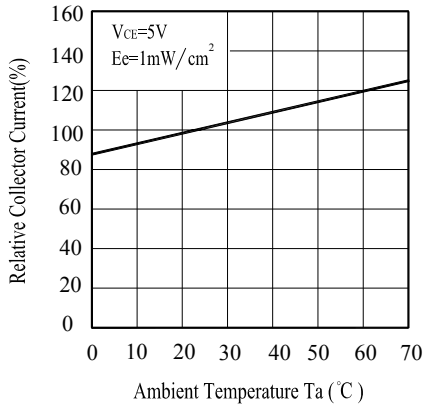

Fig.4 Collector Current vs. Irradiance

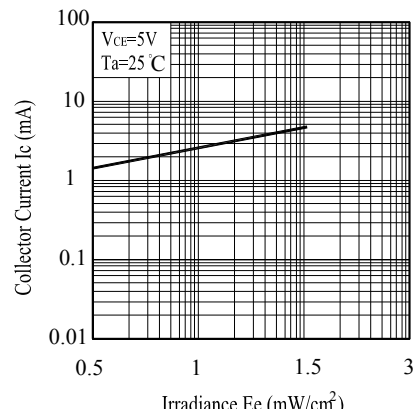

Fig.5 Collector Dark Current vs. Ambient Temperature

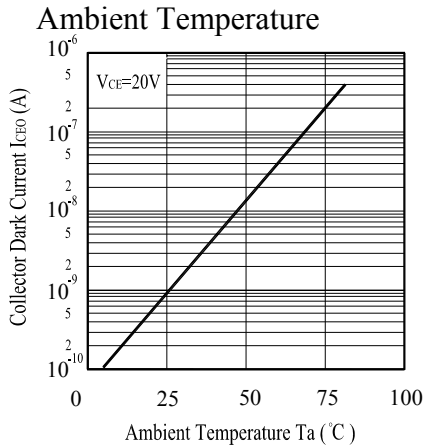
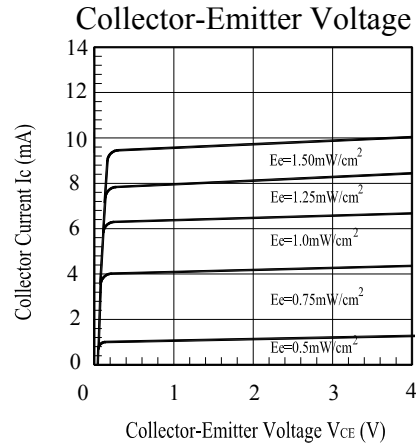

Fig.6 Collector Current vs. Collector-Emitter Voltage



**Reliability Test Item And Condition**

The reliability of products shall be satisfied with items listed below.

Confidence level : 90%

LTPD : 10%

NO.	Item	Test Condition	Test Hours/ Cycle	Sample Size	Failure Judgement Criteria	Ac/Re
1	Solder Heat	TEMP : 260°C ± 5 °C	10sec	22 PCs	More than 90% of lead to be covered by soldering  $I_R \geq U \times 2$ $E_e \leq L \times 0.8$ $V_F \geq U \times 1.2$  U :Upper specification limit L :Lower specification limit	0/1
2	Temperature Cycle	H : +100°C    15 mins $\updownarrow$ 5 min $\updownarrow$ L : -40°C    15 min	300 cycle	22 PCs		0/1
3	Thermal Shock	H : +100°C    5 min $\updownarrow$ 10 sec $\updownarrow$ L : -10°C    5 min	300 cycle	22 PCs		0/1
4	High Temperature Storage	TEMP. : +100°C	1000 hrs	22 PCs		0/1
5	Low Temperature Storage	TEMP. : -40°C	1000 hrs	22 PCs		0/1
6	DC Operating Life	$V_{CE}=5V$ $I_F=20mA$	1000 hrs	22 PCs		0/1
7	High Temperature / High Humidity	85°C / 85% R.H.	1000 hrs	22 PCs		0/1



**Packing Quantity Specification**

- 1. 120PCS/1Plate, 4Plates/1Box
- 2. 10Boxes/1Carton

**Label Form Specification**

CPN:	CPN: Customer's Production Number
P/N:	P/N : Production Number
	QTY: Packing Quantity
ITR8402-F-A	CAT: Ranks
QTY:	HUE: Peak Wavelength
	REF: Reference
LOT NO:	LOT No: Lot Number

**Notes**

- 1. Above specification may be changed without notice. EVERLIGHT will reserve authority on material change for above specification.
- 2. When using this product, please observe the absolute maximum ratings and the instructions for using outlined in these specification sheets. EVERLIGHT assumes no responsibility for any damage resulting from use of the product which does not comply with the absolute maximum ratings and the instructions included in these specification sheets.
- 3. These specification sheets include materials protected under copyright of EVERLIGHT corporation. Please don't reproduce or cause anyone to reproduce them without EVERLIGHT's consent.

<b>EVERLIGHT ELECTRONICS CO., LTD.</b> Office: No 25, Lane 76, Sec 3, Chung Yang Rd, Tucheng, Taipei 236, Taiwan, R.O.C	Tel: 886-2-2267-2000, 2267-9936 Fax: 886-2267-6244, 2267-6189, 2267-6306 <a href="http://www.everlight.com">http://www.everlight.com</a>
---	--