



Chipsmall Limited consists of a professional team with an average of over 10 year of expertise in the distribution of electronic components. Based in Hongkong, we have already established firm and mutual-benefit business relationships with customers from,Europe,America and south Asia,supplying obsolete and hard-to-find components to meet their specific needs.

With the principle of “Quality Parts,Customers Priority,Honest Operation,and Considerate Service”,our business mainly focus on the distribution of electronic components. Line cards we deal with include Microchip,ALPS,ROHM,Xilinx,Pulse,ON,Everlight and Freescale. Main products comprise IC,Modules,Potentiometer,IC Socket,Relay,Connector.Our parts cover such applications as commercial,industrial, and automotives areas.

We are looking forward to setting up business relationship with you and hope to provide you with the best service and solution. Let us make a better world for our industry!



Contact us

Tel: +86-755-8981 8866 Fax: +86-755-8427 6832

Email & Skype: info@chipsmall.com Web: www.chipsmall.com

Address: A1208, Overseas Decoration Building, #122 Zhenhua RD., Futian, Shenzhen, China



POWER

Intelligent VS Power

Up to 4920 Watts

Data Sheet

Total Power: Up to 4920 W
Input Voltage: 85 - 264 Vac
 380, 440 Vac
 120 - 300 Vdc
 1-Phase
 3-Phase
of Outputs: Up to 24



iVS™

PiMBus®
 Power Management. Defined.

SPECIAL FEATURES

- Full medical EN60601 approval
- Intelligent I²C control
- Voltage adjustment on all outputs (manual or I²C)
- Configurable input and output OK signals and indicators
- Configurable inhibit/enable
- Configurable output UP/DOWN sequencing
- High power density (12 W/cu-in)
- Intelligent fan (speed control/fault status)
- uP controlled PFC input with active Inrush protection
- I²C monitor of voltage, current, and temperature
- Programmable voltage, current limit, inhibit/enable through I²C
- Optional extended hold-up module (SEMI F47 compliance)
- Increased power density to 150%
- Optional conformal coating
- Industrial temp range (-40 °C to 70 °C)
- Uses standard iMP modules
- Field upgradeable firmware
- RoHS compliant

SAFETY

- UL UL60950/UL2601
- CSA CSA22.2 No. 234 Level 5
- UV EN60950/EN60601-1
- BABT Compliance to EN60950/EN60601 BS7002
- CB Certificate and report
- CE Mark to LVD

Electrical Specifications

Input	
Input range	iVS1 & iVS3 90 - 264 Vac 1Ø; 120 - 300 Vdc
	iVS6 & iVS8 170 - 264 Vac 3Ø
	iVS8H 396 - 480 Vac rated at 4920 W DC output 3Ø 342 - 396 Vac rated at 4200 W DC output 3Ø
Frequency	47 - 440 Hz
Inrush current	40 A peak maximum (soft start)
Efficiency	Up to 85% @ full case load
Power Factor	0.99 typ. meets EN61000-3-2
Turn-on time	AC on 1.5 sec typical, inhibit/enable 150ms typical Programmable; 50 ms internal turn-on delay (Dual Output only)
EMI Filter	CISPR 22/EN55022 Level "B". Level "A" for iVS8H
Leakage current	500 µA max. @ 240 Vac; 47-63 Hz
Radiated EMI	CISPR 22/EN55022 Level "B". Level "A" for iVS8H
Holdover storage	10 ms minimum (independent of input Vac) additional 20 mSEC holdover storage with optional HUP module (SEMI F47 compatible)
AC OK	> 5 ms early warning minutes before outputs lose regulation Full cycle ride thru (50 Hz). Programmable
Harmonic distortion	Meets EN61000-3-2
Isolation	Meets EN60950 and EN60601
Global inhibit / enable	TTL, Logic "1" and Logic "0"; configurable
Warranty	3 years

* Note: iVS8H does not have Medical Approvals

Electrical Specifications

Output	
Adjustment range*	± 10% minimum all outputs (manual) (full module adjustment range using I ² C)
Factory set point accuracy	1%
I ² C output program accuracy	± 5%
Margining	± 4 - 6% nominal analog (single output module only)
Overall regulation	0.4% or 20 mV max. (1500 W modules 1% max.)
Ripple	RMS: 0.1% or 10 mV, whichever is greater Pk-Pk: 1.0% or 50 mV, whichever is greater Bandwidth limited to 20 MHz
Dynamic response	< 2% or 100 mV, with 25% load step
Recovery time	To within 1% in < 300 µsec
Overcurrent protection**	Configurable through I ² C (calibration required). Single output module and main output of the dual output module 105 - 120% of rated output current. Aux output of dual output module 105 - 140% of rated output current. Special programmable OCP delay on 1500 W module from 100 mSec to 25.5 seconds with shutdown features.
Short-circuit protection	Protected for continuous short-circuit. Recovery is automatic upon removal of short (Shutdown mode on 1500 W module).
Overvoltage protection*	Configurable through I ² C
	Single output module: 2 - 5.5 V 122 - 134%; 6 - 60 V 110 - 120%
	Dual output module: 2 - 6 V 122 - 134%; 8 - 28 V 110 - 120%
	Triple output module: 110 - 120% of highest voltage rating
Thermal protection*	Configurable through I ² C All outputs disabled when internal temp exceeds safe operating range. > 5 ms warning (AC OK signal) before shutdown
Remote sense	Up to 0.5 V total drop (not available on triple output module)
Single wire parallel	Current share to within 2% of total rated current
DC OK*	± 5% of nominal. Configurable through I ² C
Minimum load	Not required
Housekeeping bias voltage	5 Vdc @1.0 A max. present whenever AC input is applied Overall Regulation: ± 5% Ripple and Noise: 150 mV pk-pk, Bandwidth limited to 150 MHz and measured with 10 µF Tantalum capacitor and 0.1 µF ceramic capacitor in parallel on the output.
Module inhibit*	Configured and controlled through I ² C
Output/Output isolation	> 1 Megohm, 500 V

* Can be controlled via I²C** Controlled via I²C but requires load calibration (except 1500 W module)

Environmental Specifications

Operating temperature	-40 ° to 70 °C ambient. Derate each output 2.5% per degree from 50 ° to 70 °C. (-20 °C start up)
Storage temperature	-40 °C to +85 °C
Electromagnetic susceptibility	Designed to meet EN61000-4; -2, -3, -4, -5, -6, -8, -11 Level 3
Humidity	Operating; non-condensing 10% to 95% RH
Vibration	IEC68-2-6 to the levels of IEC721-3-2
MTBF demonstrated	> 550,000 hours at full load, 220 Vac and 25 °C ambient conditions

Output Module Line-up

Module Code	1	2	3	5	4		—
Module Type	Single	Single	Single	Single	Dual		Triple
Max output power	210 W	360 W	750 W	1500 W	144 W		36 W
Max output current	35 A	60 A	150 A	300 A	10 A		2 A
Output voltages available*	2 - 60 V	2 - 60 V	2 - 60 V	2 - 60 V	8 - 15*, 24 - 28; 8 - 15*, 8 - 15*; 8 - 15*, 2 - 6; 2 - 6, 2 - 6; 24 - 28, 24 - 28; 24 - 28, 2 - 6		8 - 15, 8 - 15, 2 - 6; 8 - 15, 8 - 15, 8 - 15; 8 - 15, 8 - 15, 18 - 28; 8 - 15, 18 - 28, 2 - 6
Standard voltage increments	25	25	25	25	16		18
Remote sense	Yes	Yes	Yes	Yes	Yes	Yes	No
Remote margin	Yes	Yes	Yes	Yes	No	No	No
V-Program - I ² C Control	Yes	Yes	Yes	Yes	Yes	Yes	No
Active Current Share	Yes	Yes	Yes	Yes	Yes	No	No
Module Inhibit - I ² C Control	Yes	Yes	Yes	Yes	Yes	Yes	Yes
Module Inhibit - Analog	Yes	Yes	Yes	Yes	Yes	No	No
Overvoltage/Overcurrent protection	Yes	Yes	Yes	Yes	Yes	Yes	Yes
Minimum load required	No	No	No	No	No	No	No
Slots occupied in any iVS case	1	2	3	4	1		1

* Note: Contact Factory for extended range down to 6 V

Single

Dual

Triple



210 W

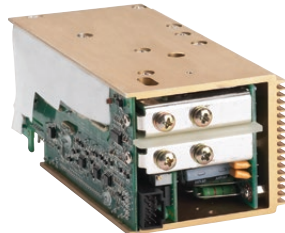

750 W



144 W



36 W



360 W



1500 W (2.0 - 8.0 V)



1500 W (10 - 60 V)



1500 W with Bus Bar Adaptor Option
(used with the 10 - 60 V module)

Output Module Voltage/Current*

Voltage	Voltage Code	Single Output Module Code				Dual Output***		Triple Output			I ² C Adjustment Ranges****
		1	2	3	5	4	4	-	-	-	
2 V	A	35 A	60 A	150 A	300 A	10 A	10 A	—	—	2 A	1.8 - 2.2
2.2 V	B	35 A	60 A	150 A	300 A	10 A	10 A	—	—	2 A	2.0 - 2.4
3 V	C	35 A	60 A	150 A	300 A	10 A	10 A	—	—	2 A	2.7 - 3.3
3.3 V	D	35 A	60 A	150 A	300 A	10 A	10 A	—	—	2 A	3.0 - 3.6
5 V	E	35 A	60 A	150 A	300 A	10 A	10 A	—	—	2 A	4.5 - 5.5
5.2 V	F	35 A	60 A	144 A	288 A	10 A	10 A	—	—	2 A	4.7 - 5.7
5.5 V	G	34 A	58 A	136 A	273 A	10 A	10 A	—	—	2 A	5.0 - 6.1
6.0 V	H	23 A	42 A	97.5 A	250 A	10 A*	10 A*	—	—	2 A	5.4 - 6.6
8.0 V	I	20 A	36 A	84.4 A	187.5 A	10 A	4 A	1 A	1 A	1 A	7.2 - 8.8
10 V	J	18 A	32 A	75 A	140 A	10 A	4 A	1 A	1 A	1 A	9.0 - 11.0
11 V	K	17 A	31 A	68 A	136.3 A	10 A	4 A	1 A	1 A	1 A	9.9 - 12.1
12 V	L	17 A	30 A	62.5 A	125 A	10 A	4 A	1 A	1 A	1 A	10.8 - 13.2
14 V	M	14 A	21 A	53.5 A	107 A	9 A	4 A	1 A	1 A	1 A	12.6 - 15.4
15 V	N	14 A	20 A	50 A	100 A	8 A	4 A	1 A	1 A	1 A	13.5 - 16.5
18 V	O	11 A	19 A	41.6 A	83.3 A	—	—	—	0.5 A	0.5 A	16.2 - 19.8
20 V	P	10.5 A	18 A	37.5 A	75 A	—	—	—	0.5 A	0.5 A	18.0 - 22.0
24 V	Q	8.5 A	15 A	30 A	62.5 A	4 A	2 A	—	0.5 A	0.5 A	21.6 - 26.4
28 V	R	6.7 A	11 A	26.8 A	53.5 A	3 A	2 A	—	0.5 A	0.5 A	25.2 - 30.8
30 V	S	6.5 A	11 A	25 A	50 A	—	—	—	—	—	27.0 - 33.0
33 V	T	6.2 A	10.9 A	22.7 A	35.8 A	—	—	—	—	—	29.7 - 36.3
36 V	U	5.8 A	10 A	20.8 A	35.8 A	—	—	—	—	—	32.4 - 39.6
42 V	V	4.2 A	7.5 A	16 A	35.7 A	—	—	—	—	—	37.8 - 46.2
48 V	W	4.0 A	7.5 A	15.6 A	31.2 A	—	—	—	—	—	43.2 - 52.8
54 V	X	3.7 A	6.0 A	13.9 A	27.7 A	—	—	—	—	—	48.6 - 59.4
60 V	Y	3.5 A	6.0 A	12.5 A	25 A	—	—	—	—	—	54.0 - 66.0
Contact Factory											
Special*	Z	35 A	60 A	150 A	300 A	—	10 A				2.3 - 2.6
Special*	Z	35 A	60 A	150 A	300 A	—	10 A				3.7 - 4.4
Special*	Z	20 A	36 A	80 A	140 A	—	8 A				6.7 - 7.1

* Note: Contact Factory for extended range down to 6 V.

** Increments of current not shown can be achieved by paralleling modules (add currents of each module selected).

*** Total output power on dual model must not exceed 144 W.

**** For single output modules only.

Green reference lines indicate physical module groupings

Ordering Information

Sample below is 3210 W case with 12 V @ 125 A; 24 V @ 8.5 A; 5 V @ 60 A; 12 V @ 10 A and 12 V @ 4 A; with no options.

Case Size	Module/Voltage/Option Codes	Case Option Codes	Software Code	Hardware Code
<p>iVS1</p> <p>Case Size (mm) 1-Phase Input 1 = 5" x 5" x 11"; 1500 W - 3210 W, 9 Slots (127 x 127 x 279.4 mm) 3 = 5" x 8" x 11"; 1800 W - 4500 W, 14 Slots (127 x 203.2 x 279.4 mm) 3-Phase Input 6 = 5" x 5" x 11"; 3120 W, 9 Slots (127 x 127 x 279.4 mm) 8, 8H = 5" x 8" x 11"; 4920 W, 14 Slots (127 x 203.2 x 279.4 mm)</p>	<p>Module/Voltage/Option Codes First - Module Code Second - Voltage Code Third - Option Code</p> <p>5L1 - 1Q1 - 2EO - 4LL0</p> <p>Module Codes: (None) = 36 W triple O/P (1 slot) 1 = 210 W single O/P (1 slot) 2 = 360 W single O/P (2 slot) 3 = 750 W single O/P (3 slot) 5 = 1500 W single O/P (slot 4) 4 = 144 W dual O/P (1 slot) HUP = Extra 30mS hold-up (1 slot) Voltage Codes: See Output Module Voltage/Current table Option Codes: 0 = Standard 1 = Module enable 2 = Constant current 3 = 1 & 2 combined 4 = Set for use in standard (non-intelligent case) 5 = Shutdown mode for 1500 W 6 = 1 & 5 combined 7-9 Future</p>	<p>00</p> <p>First Digit 0 - 9, A - Z Parallel code (See parallel codes table below) Second Digit 0 = No options 1 = Reverse air 2 = Not used 3 = Global enable 4 = Fan Idle w/inhibit 5 = Opt 1 + Opt 3 6 = Opt 1 + Opt 4 7 = Opt 3 + Opt 4 8 = Opt 1 + 3 + 4 9 = RS485 73-544-001 B = USB 73-546-001 C = 9 + 3 D = CANBUS 73-544-004 E = D + 3</p>	<p>A</p> <p>Software code used for configuration change. "A" is standard</p>	<p>###</p> <p>Factory assembled for hardware of firmware mods.</p>

Ordering Note:

1. USB to I²C module order code 73-769-001

Ordering Information

Parallel Code	Slot No.	iVS1, 6		iVS3, 8H	
		Diagram	Possible Configurations	Diagram	Possible Configurations
1	1 & 2		210 210; 210 144; 144 144		210 210; 210 144; 144 144
2	2 & 3		360 360; 360 210; 360 144; + above		360 360; 360 210; 360 144; + above
3	3 & 4		750 360; 750 210; 750 144; 210 210; 210 144; 144 144		750 750; 750 360; 750 210; 750 144; 210 210; 210 144; 144 144
4	4 & 5		1500 210; 1500 144; 210 210; 210 144; 144 144; 360 210; 360 144		1500 1500; 1500 750; 1500 360; 1500 210; 1500 144; 210 210; 210 144; 144 144; 360 360; 360 210; 360 144
5	3, 4, & 5		750 210 210; 750 210 144; 750 144 144		750 210 210; 750 210 144; 750 144 144
6	iVS1,6: 4 & 6		1500 1500; 1500 750		
7	4, 5, & 6		1500 210 210; 1500 210 144; 1500 144 144; 1500 210 1500		1500 210 210; 1500 210 144; 1500 144 144
8	iVS1,6: 3 & 6 iVS3,8: 4, 5, & 9		750 750		1500 1500 1500; 1500 1500 750; 1500 1500 360; 1500 1500 210; 1500 1500 144
9	iVS1,6: 1 & 6 iVS3, 8: 4, 5 & 9; 12 & 13		1500 1500; 1500 360; 1500 144		1500 1500 1500 360; 1500 1500 1500 210; 1500 1500 1500 144
A	iVS1,6: 3 & 4; 8 & 9 iVS3, 8: 4 & 5; 11 & 12		750 210 & 750 210		1500 1500 & 750 750
C	iVS1,6: 3, 4 & 6 iVS3, 8: 6 & 7; 3, 4, 11 & 12		750, 360, 750		750 750 360 750 750
E	iVS1,6: 3, 4, 6; 8 & 9 iVS3, 8: 3, 4, 11, & 12		750, 360, 750, 210		750 750 750 750
F	iVS1,6: 7-8 iVS3, 8: 3 & 4; 11 & 12		360, 360		750 360 & 750 210; 750 750 & 750 750
G	iVS3, 8: 3,4 & 9				750 750 750
H	iVS3, 8: 11 & 12				750 750
J	iVS3, 8: 4 & 5; 9 & 10				1500 210 & 210 1500
K	iVS3, 8: 1 & 9; 5 & 12				1500 750 & 1500 750
L	iVS3, 8: 3 & 4; 7 & 8; 9 & 10				750 210 & 750 210 & 210 1500
M	iVS3, 8: 3, 4 & 9; 6 & 7				750 750 360 750
N	iVS3, 8: 4, 5 & 9; 12,13 & 14				1500, 1500, 1500, 210, 210
P	iVS3, 8: 1 & 9				1500, 750

iVS Case Specifications

iVS1 and iVS6

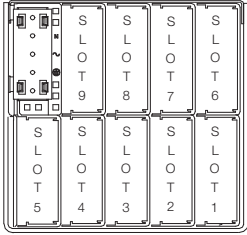

iVS1 = 5" x 5" x 11" (127 x 127 x 279.4 mm) 9 available slots	90 - 264 Vac 1500 W max.	Input 170 - 264 Vac 3210 W max.
iVS6 = 5" x 5" x 11" (127 x 127 x 279.4 mm) 9 available slots 3-phase only	N/A	170 - 264 Vac 3210 W max.

iVS3, iVS8 and iVS8H

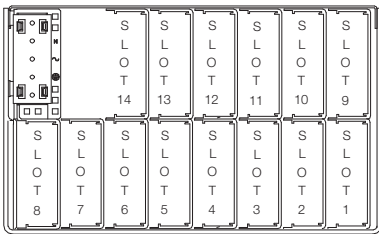

iVS3 = 5" x 8" x 11" (127 x 203.2 x 279.4 mm) 14 available slots	90 - 264 Vac 1800 W max.	Input 170 - 264 Vac 4500 W max.
iVS8 = 5" x 8" x 11" (127 x 203.2 x 279.4 mm) 14 available slots	90 - 264 Vac 1800 W max.	170 - 264 Vac 4500 W max.
iVS8H = 5" x 8" x 11" (127 x 203.2 x 279.4 mm) 14 available slots	90 - 264 Vac 1800 W max.	380 Vac 440 Vac 4920 W max.

Pin Connectors

Figure 1. AC Input

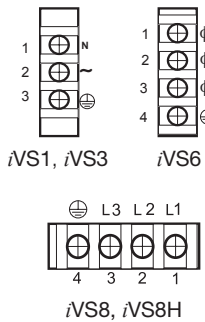

AC Input	Single Phase	3 Phase
<i>Pin</i>	<i>Function</i>	
1	AC neutral	Line 1
2	AC line (hot)	Line 2
3	Chassis (earth) ground	Line 3
4	Not used	Chassis (earth) ground

Figure 2. Connector J1

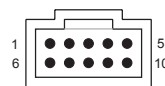

Mates with
Molex 90142-0010 Housing
90119-2110 Pin

Connector Kit Part No.:
70-841-004

PFC Input Connector (control & signals)	
<i>Pin</i>	<i>Function</i>
1	Input AC OK - "emitter"
2	Input AC OK - "collector"
3	Global DC OK - "emitter"
4	Global DC OK - "collector"
5	Spare
6	Global inhibit/optional enable logic "0"
7	Global inhibit/optional enable logic "1"
8	Global inhibit/optional enable return
9	+5 VSB housekeeping
10	+5 VSB housekeeping return

Figure 3. Connector J2



Mates with
Landwin 2050S1000 Housing
2053T011V Pin

or

JST PHDR-10VS Housing
JST SPHD-002T-P0.5 (28-24)
JST SPHD-001T-P0.5 (26-22)

Connector Kit Part No.:
70-841-023

I ² C Bus Output Connector	
<i>Pin</i>	<i>Function</i>
1	No connection
2	No connection
3	No connection
4	Serial clock signal (SCL)
5	Serial data signal (SDA)
6	Address bit 0 (A0)
7	Address bit 1 (A1)
8	Address bit 2 (A2)
9	Secondary return (GND)
10	5 VCC external bus (5 VCC bus)

Mechanical Drawings

iMP Modules

DC-DC Converter Output Modules

Control Signal Information, J1 Control Connector

Pin No.	Function	
1	+ Remote Sense	single or dual o/p main
2	Remote Margin / V. Program	single o/p
3	Margin High	single o/p
4	- Remote Sense / Margin Low	single or dual o/p main
5	Spare	
6	Module, Isolated Inhibit	single or dual o/p
7	Module Inhibit Return	single or dual o/p
8	Current Share (SWP)	single or dual o/p main
9	+ Remote Sense V2	dual o/p, single is spare
10	- Remote Sense V2	dual o/p, single is spare

* Note: All iMP modules have a green DCOK LED. (except for 36 W module)

Figure 4. Connector J1

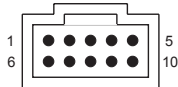

Mates with
Molex 90142-0010 Housing
90119-2110 Pin

Single 210 Watt

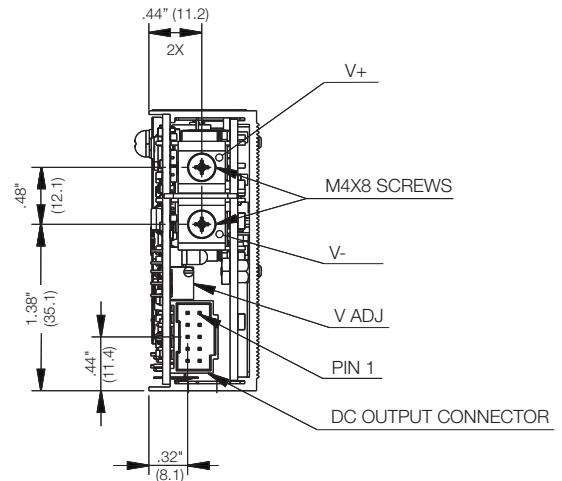

Single 360 Watt

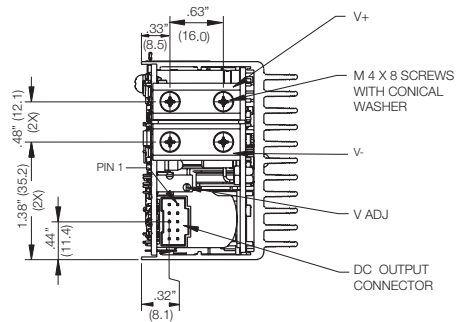

Single 750 Watt

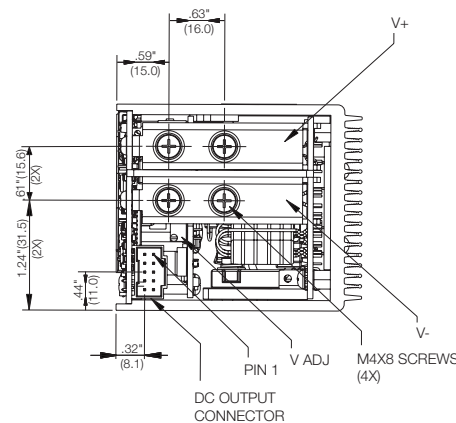

Single 1500 Watt 8 - 60 V

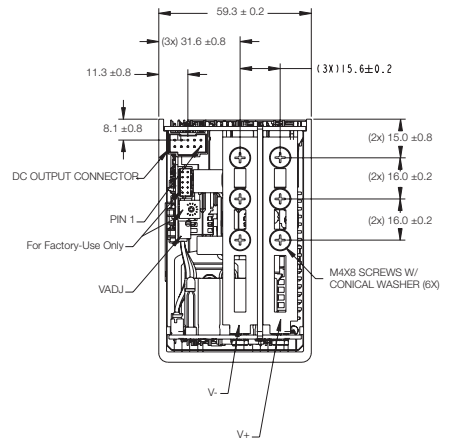

Dual 144 Watt

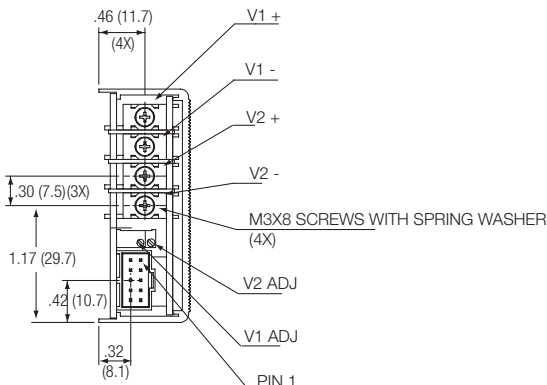

Triple 36 Watt

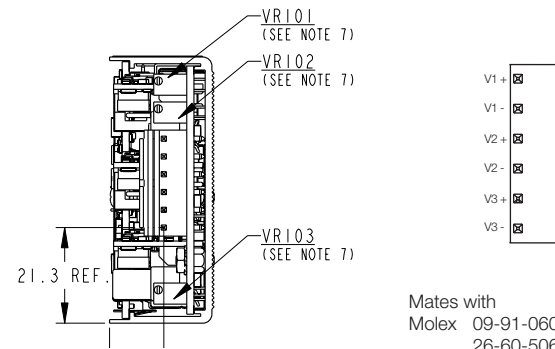

Mates with
Molex 09-91-0600 Housing
26-60-5060 Pin

iVS Series

iVS1 (1500/3210 Watts Max)

5-Inch Case Size: iVS1: 5" x 5" x 11" (127 mm x 127 mm x 279.4 mm)

Weight: iVS1 Case: 6.2 lbs. • 1500 W Single: 2.0 lbs. • 750 W Single: 1.6 lbs.
 • 360 W Single: 1.0 lb. • 210 W Single: 0.6 lb. • 144 W Dual: 0.6 lb.

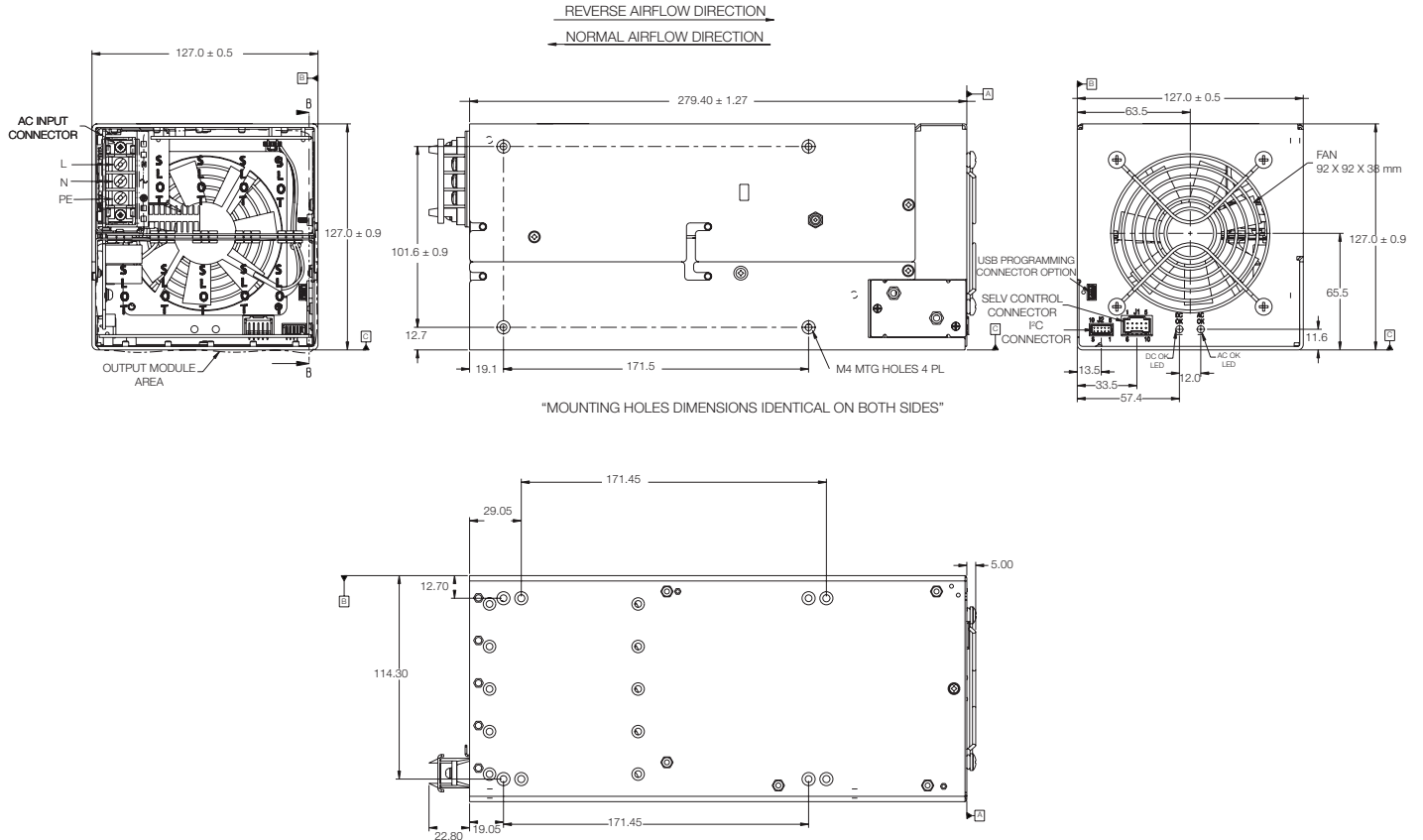

Notes:

1. Input: Barrier type. Three No. 6-32 B.H. screws (0.375" centers). Max torque: 6 in-lbs. (0.67 N-m).
2. Control connectors: (J1) 10 position housing, gold plated contacts. Mates with Molex 90142-0010 housing with 90119-2110 crimp contacts (Molex C - Grid III Series). Connector kit includes mating connector and 10 pins, Astec part #70-841-004. (J2) 10 position housing (Landwin 2051P1000T). Mates with housing 2050S1000 (Landwin) with 2053T011P (Landwin) pins.
3. Chassis material: aluminum with chemical film coating (conductive).
4. All dimensions are in millimeters and inches, and are typical.
5. Customer mounting -3 sides M4, bottom also includes 8-32 mounting holes. Max. penetration is 0.155" (4.0 mm). Max. torque: 5 in-lbs. (0.57 N-m).
6. Output module connections: All single O/P modules are M4 x 8 mm screws. Max. torque: 10 in-lbs. (1.13 N-m). Dual O/P module is M3 x 8 mm screws. Max. torque: 5 in-lbs. (0.57 N-m).

iVS Series

iVS3 (1800/4500 Watts Max)

8-Inch Case Size: iVS3: 5" x 8" x 11" (127 mm x 203.2 mm x 279.4 mm)

Weight: iVS3 Case: 9.0 lbs. • 1500 W Single 2.0 lbs. • 750 W Single: 1.6 lbs.
 • 360 W Single: 1.0 lb. • 210 W Single: 0.6 lb. • 144 W Dual: 0.6 lb.

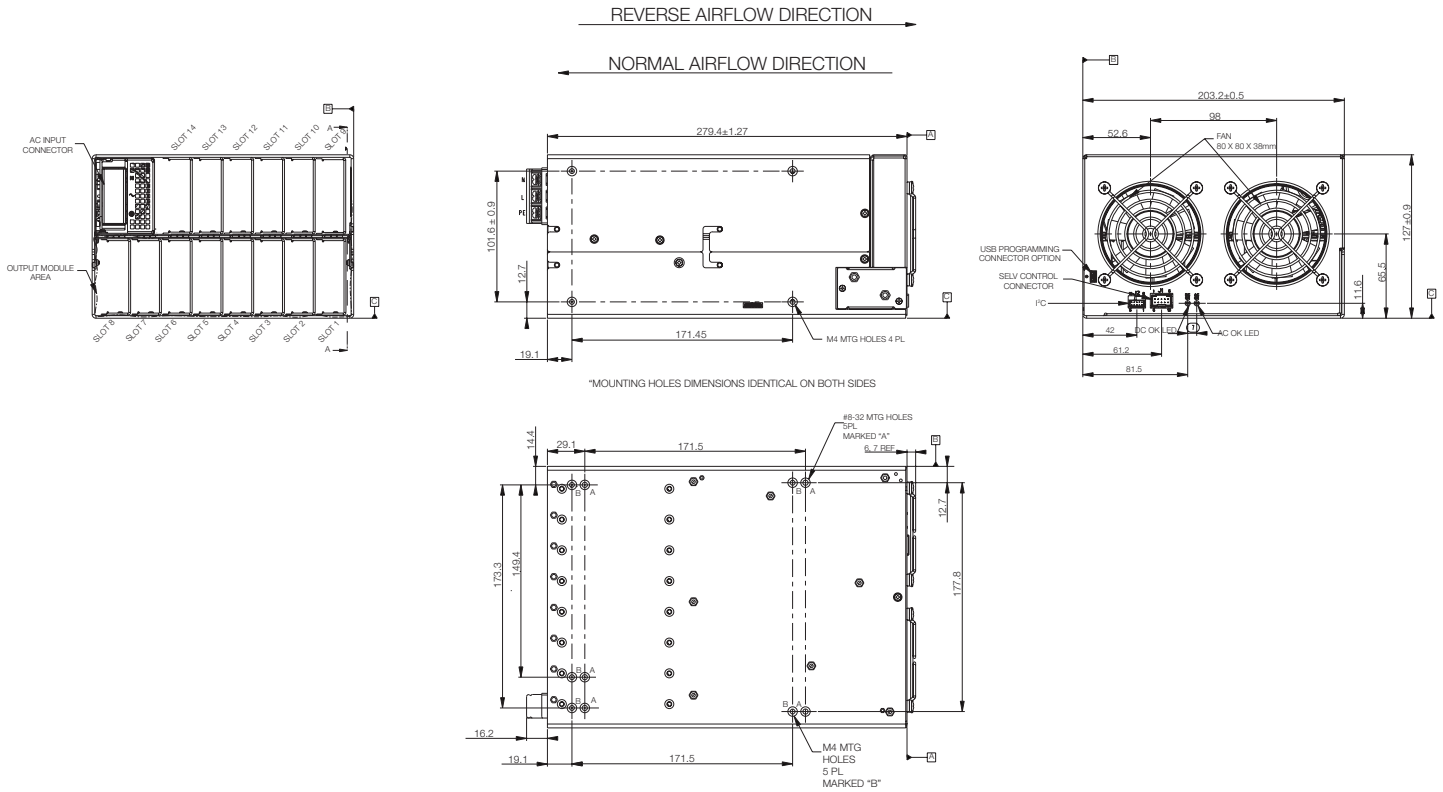

Notes:

1. Input: Barrier type. Three M4 screws (0.512" centers). Max torque: 7 in-lbs. (0.79 N-m).
2. Control connectors: (J1) 10 position housing, gold plated contacts. Mates with Molex 90142-0010 housing with 90119-2110 crimp contacts (Molex C - Grid III Series). Connector kit includes mating connector and 10 pins, Astec part #70-841-004. (J2) 10 position housing (Landwin 2051P1000T). Mates with housing 2050S1000 (Landwin) with 2053T011P (Landwin) pins.
3. Chassis material: aluminum with chemical film coating (conductive).
4. All dimensions are in millimeters and inches, and are typical.
5. Customer mounting -3 sides M4, bottom also includes 8-32 mounting holes. Max. penetration is 0.155" (4.0 mm). Max. torque: 5 in-lbs. (0.57 N-m).
6. Output module connections: All single O/P modules are M4 x 8 mm screws. Max. torque: 10 in-lbs. (1.13 N-m). Dual O/P module is M3 x 8 mm screws. Max. torque: 5 in-lbs. (0.57 N-m).

iVS Series

iVS6 (3210 Watts Max)

5-Inch Case Size: iVS6: 5" x 5" x 11" (127 mm x 127 mm x 279.4 mm)

Weight: iVS6 Case: 6.0 lbs. • 1500 W Single 2.0 lbs. • 750 W Single: 1.6 lbs.
 • 360 W Single: 1.0 lb. • 210 W Single: 0.6 lb. • 144 W Dual: 0.6 lb.

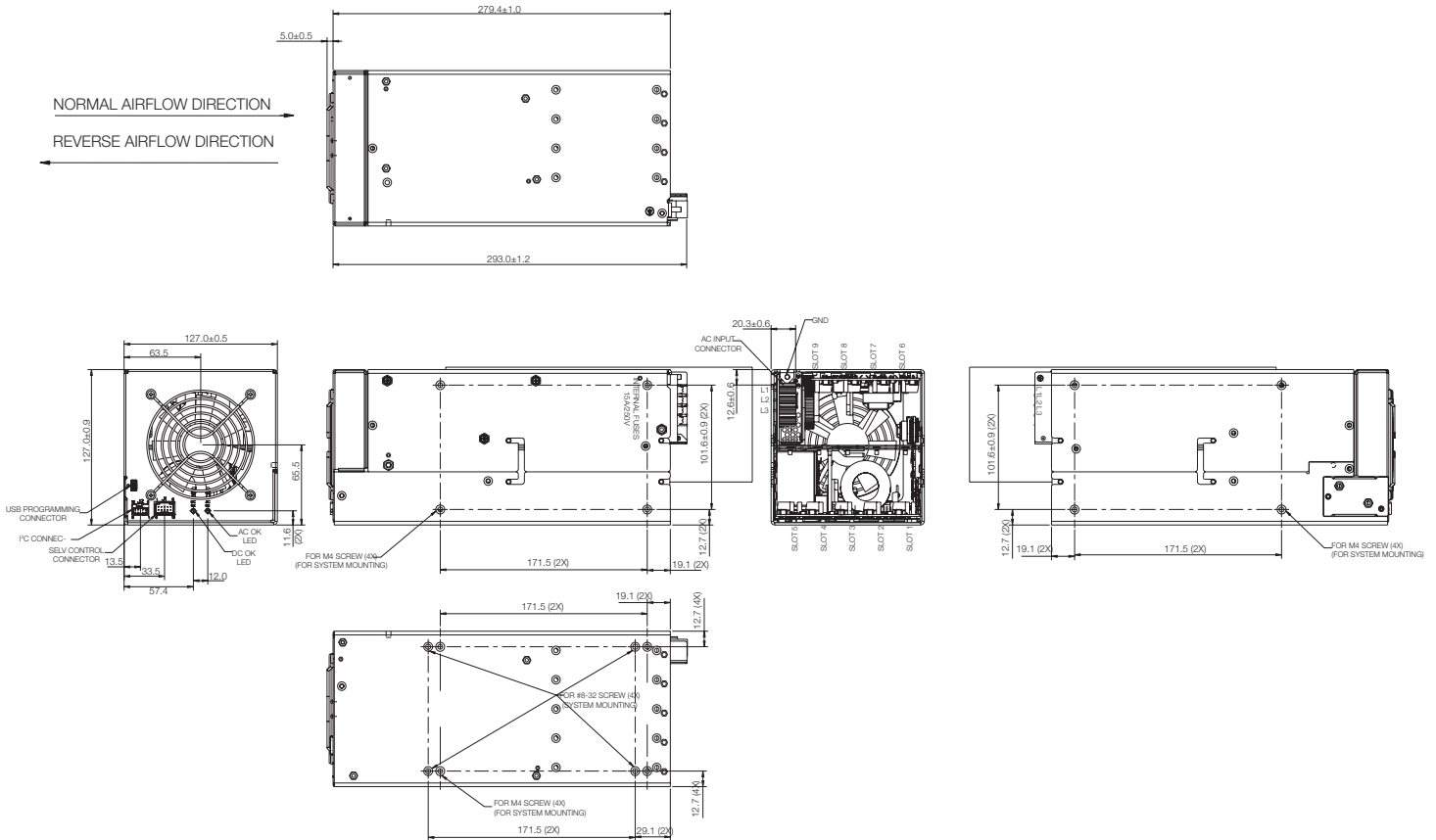

Notes:

1. Input: Barrier type. Four M3 screws (0.325" centers). Max torque: 6 in-lbs. (0.67 N-m).
2. Control connectors: (J1) 10 position housing, gold plated contacts. Mates with Molex 90142-0010 housing with 90119-2110 crimp contacts (Molex C - Grid III Series). Connector kit includes mating connector and 10 pins, Astec part #70-841-004. (J2) 10 position housing (Landwin 2051P1000T). Mates with housing 2050S1000 (Landwin) with 2053T011P (Landwin) pins.
3. Chassis material: aluminum with chemical film coating (conductive).
4. All dimensions are in millimeters and inches, and are typical.
5. Customer mounting -3 sides M4, bottom also includes 8-32 mounting holes. Max. penetration is 0.155" (4.0 mm). Max. torque: 5 in-lbs. (0.57 N-m).
6. Output module connections: All single O/P modules are M4 x 8 mm screws. Max. torque: 10 in-lbs. (1.13 N-m). Dual O/P module is M3 x 8 mm screws. Max. torque: 5 in-lbs. (0.57 N-m).

iVS Series

iVS8 (4920 Watts Max)
iVS8H (4920 Watts Max)

8-Inch Case Size: iVS8: 5" x 8" x 11" (127 mm x 203.2 mm x 279.4 mm)

Weight: iVS8 Case: 9.0 lbs. • 1500 W Single 2.0 lbs. • 750 W Single: 1.6 lbs.
• 360 W Single: 1.0 lb. • 210 W Single: 0.6 lb. • 144 W Dual: 0.6 lb.

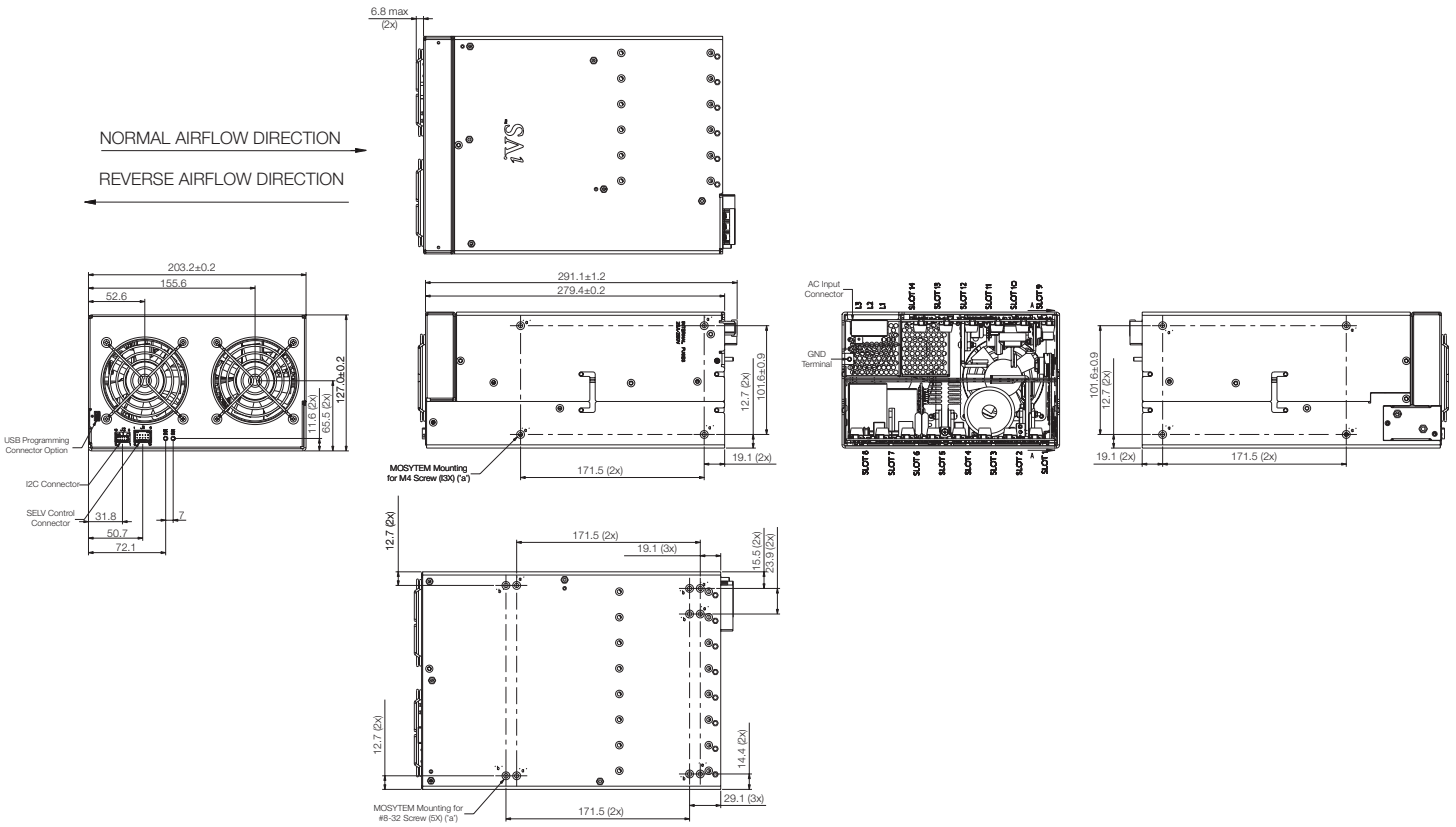

Notes:

1. Input: Barrier type. Three M3.5 screws (0.394" centers). Max torque: 6 in-lbs. (0.67 N-m).
2. Control connectors: (J1) 10 position housing, gold plated contacts. Mates with Molex 90142-0010 housing with 90119-2110 crimp contacts (Molex C - Grid III Series). Connector kit includes mating connector and 10 pins, Astec part #70-841-004. (J2) 10 position housing (Landwin 2051P1000T). Mates with housing 2050S1000 (Landwin) with 2053T011P (Landwin) pins.
3. Chassis material: aluminum with chemical film coating (conductive).
4. All dimensions are in millimeters and inches, and are typical.
5. Customer mounting -3 sides M4, bottom also includes 8-32 mounting holes. Max. penetration is 0.155" (4.0 mm). Max. torque: 5 in-lbs. (0.57 N-m).
6. Output module connections: All single O/P modules are M4 x 8 mm screws. Max. torque: 10 in-lbs. (1.13 N-m). Dual O/P module is M3 x 8 mm screws. Max. torque: 5 in-lbs. (0.57 N-m).

Optional CANBUS or RS485 Interface

The RS485/CAN-to-I²C uses 2 Input Protocols and 1 Output Protocol.

The Input Protocols used are RS485 using Modbus (Command Index: 0x01), and CAN using modified Modbus (Command Index: 0x02).

The Output Protocol use is: I²C with SMBus support (Command Index: 0x80).

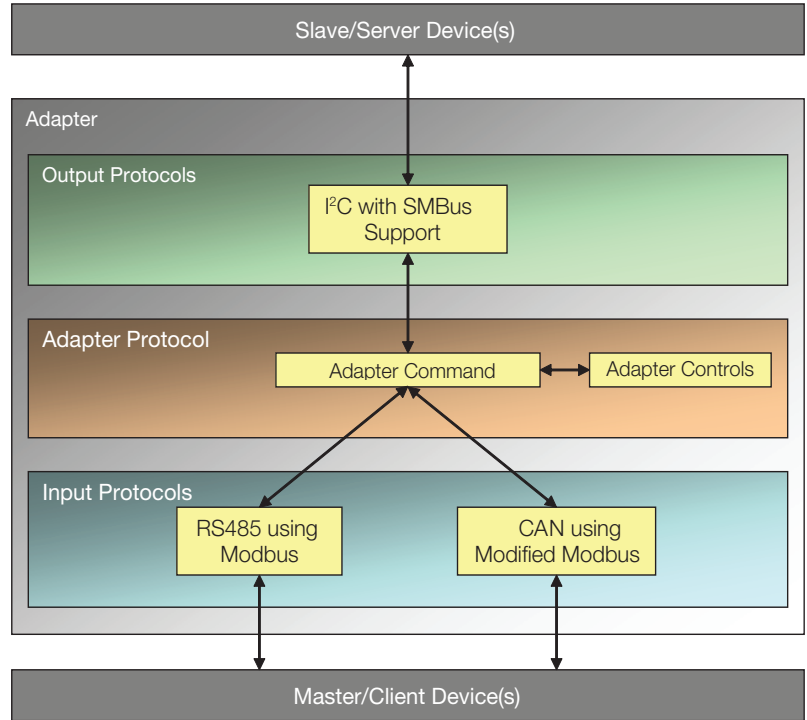

RS485/CAN - to - I²C

For detailed info, download the Software Requirements Specification (SRS) from <http://www.artesyn.com/power/power-supplies/category.php?catID=103>



iVS CAN RS485

iVS I²C USB

WORLDWIDE OFFICES

Americas

2900 S.Diablo Way
Tempe, AZ 85282
USA
+1 888 412 7832

Europe (UK)

Waterfront Business Park
Merry Hill, Dudley
West Midlands, DY5 1LX
United Kingdom
+44 (0) 1384 842 211

Asia (HK)

14/F, Lu Plaza
2 Wing Yip Street
Kwun Tong, Kowloon
Hong Kong
+852 2176 3333

ARTESYN[™]
EMBEDDED TECHNOLOGIES

www.artesyn.com

Artesyn Embedded Technologies, Artesyn and the Artesyn Embedded Technologies logo are trademarks and service marks of Artesyn Embedded Technologies, Inc. All other names and logos referred to are trade names, trademarks, or registered trademarks of their respective owners. Specifications are subject to change without notice. © 2017 Artesyn Embedded Technologies, Inc. All rights reserved. For full legal terms and conditions, please visit www.artesyn.com/legal.

For more information: www.artesyn.com/power
For support: productsupport.ep@artesyn.com