



Chipsmall Limited consists of a professional team with an average of over 10 year of expertise in the distribution of electronic components. Based in Hongkong, we have already established firm and mutual-benefit business relationships with customers from,Europe,America and south Asia,supplying obsolete and hard-to-find components to meet their specific needs.

With the principle of “Quality Parts,Customers Priority,Honest Operation,and Considerate Service”,our business mainly focus on the distribution of electronic components. Line cards we deal with include Microchip,ALPS,ROHM,Xilinx,Pulse,ON,Everlight and Freescale. Main products comprise IC,Modules,Potentiometer,IC Socket,Relay,Connector.Our parts cover such applications as commercial,industrial, and automotives areas.

We are looking forward to setting up business relationship with you and hope to provide you with the best service and solution. Let us make a better world for our industry!



Contact us

Tel: +86-755-8981 8866 Fax: +86-755-8427 6832

Email & Skype: info@chipsmall.com Web: www.chipsmall.com

Address: A1208, Overseas Decoration Building, #122 Zhenhua RD., Futian, Shenzhen, China



16V Input Voltage Step-Down DC/DC Controller

FEATURES

- Operating Input Voltage Range: 2.8V ~ 16.0V
- Output Voltage Range Externally Set: > 1.2V
- Output Current: up to 3A
- Reference Voltage: 0.9V ± 1.5%
- Oscillation Frequency: 300 kHz, 500 kHz and 1 MHz
- Operating Mode: PWM (IXD3220) or PWM/PFM automatically switching (IXD3221)
- Soft Start: 4 ms internal (IXD3220A/221A) or > 4 ms externally set (IXD3220B/221B)
- Protection: Integral and Short Circuit
- Small Package: SOT-25, USP-6C

APPLICATION

- Set top boxes
- Digital TVs
- DVD/HDD recorders
- Various portable equipment

DESCRIPTION

The IXD3220/221 series are multi-purpose step-down DC/DC controllers, which require only a transistor, a coil, a diode, and two capacitors connected externally to create a high efficiency stable power supply with output current up to 3A. Low ESR ceramic capacitors can be used as an output capacitor.

The IXD3220/221 series has a 0.9 V (±1.5%) reference voltage, which allows set output voltage in wide range using external resistive divider.

Switching frequency of 300 kHz, 500 kHz, and 1.0 MHz allows use of small external components.

TYPICAL APPLICATION CIRCUIT

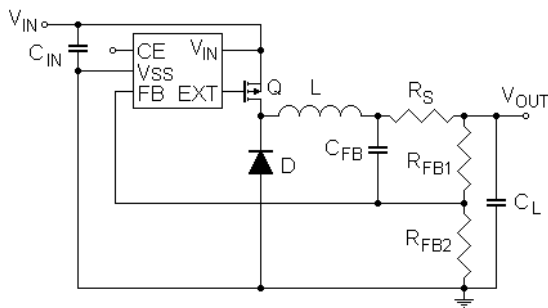

R_S requires with low ESR (ceramic) capacitors used as C_L. Neither tantalum or aluminum capacitors require R_S

The IXD3220 series utilize PWM mode, while the IXD3221 series utilize either PWM or PFM mode, automatically switching from PWM to PFM at light loads to achieve high efficiency over a wide range of load conditions.

The IXD3220/221 series A and C versions have soft start function internally set to 4 ms, and the IXD3220/221 series B and D versions allow set-up soft start externally.

The built-in UVLO (Under Voltage Lock Out) function forces the external P-channel transistor in OFF state when input voltage becomes 2.3V or lower.

If the FB pin is shorted to the Ground or the output voltage drops rapidly because of overload, resulting in V_{FB} < 0.7 V, the external P-channel transistor is forced OFF and latched in this state.

The latching state does not mean a complete shutdown, but a state in which pulse output is suspended; but the internal circuitry remains in operation. To restart circuit, either V_{IN} or CE pin should be triggered.

Integral Protection Circuit monitors the duty cycle at EXT pin. In case of high load, when duty cycle ratio exceed maximum allowed value a certain amount of time (t_{PRO}), the EXT pin latches at high level and keeps the external P-channel transistor in OFF state. To restart circuit, either V_{IN} or CE pin should be triggered.

For the applications with small dropout voltage, working close to maximum allowed duty cycle ratio, the IXD3220/221 series C or D versions without the integral protection are recommended.

TYPICAL PERFORMANCE CHARACTERISTIC

Efficiency vs. Output Current

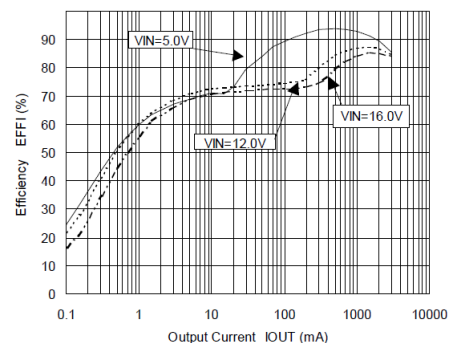

IXD3221A095MR - V_{OUT} = 3.3 V, f_{OSC} = 500 kHz, C_{IN} = C_L = 47 μF (OS-Con), L = 10 μH (CDRH8D43, (SUMIDA), Q - CPH3308, C_{FB} = 1.0 μF (ceramic), R_{FB} = 10Ω

ABSOLUTE MAXIMUM RATINGS

PARAMETER	SYMBOL	RATINGS	UNITS
V _{IN} Pin Voltage	V _{IN}	-0.3 ~ 18.0	V
FB Pin Voltage	V _{FB}	-0.3 ~ 18.0	V
CE/C _{SS} Pin Voltage	CE	-0.3 ~ 18.0	V
EXT Pin Voltage	V _{EXT}	V _{SS} - 0.3 ~ V _{OUT} + 0.3	V
EXT Pin Current	I _{EXT}	±100	mA
Power Dissipation	SOT-25	250	mW
	USP-6C	100	
Operating Temperature Range	T _{OPR}	-40 ~ +85	°C
Storage Temperature Range	T _{STG}	-55 ~ +125	°C

ELECTRICAL OPERATING CHARACTERISTICS

IXD3220/221 A and C versions

Unless otherwise specified, V_{IN} = 5 V, Ta = 25 °C

PARAMETER	SYMBOL	CONDITIONS	MIN.	TYP.	MAX.	UNIT	CIRCUIT
FB Voltage	V _{FB}		0.8865	0.9000	0.9135	V	②
Input Voltage Range	V _{IN}		2.8	-	16.0	V	
UVLO Voltage (Minimum Operating Voltage)	V _{UVLO}		1.9	2.3	2.7	V	③
Supply Current 2	I _{DD2}	V _{IN} = 5.0 V, V _{FB} = 1.0 V		**		μA	①
Standby Current	I _{STB}			0.1	1	μA	①
Oscillation Frequency	f _{OSC}	Connected to external components		**		kHz	③
Maximum Duty Cycle Ratio	D _{MAX}		100	-	-	%	②
PFM Duty Cycle Ratio	D _{PFM}	No load IXD3221 series only	15	25	35	%	③
EXT "H" ON Resistance	R _{EXTH}		6	10	16	Ω	④
EXT "L" ON Resistance	R _{EXTL}		6	12	20	Ω	④
Integral Protection Time (*2)	t _{PRO}	IXD3220/221 A series		**		ms	②
Short-Circuit Protection	V _{SHRT}				0.7	V	②
Soft-Start Time	t _{SS}			**		ms	②
Efficiency (*1)	EFF1			92		%	③
FB Voltage Temperature Characteristics	$\frac{\Delta V_{FB}}{V_{FB} * \Delta t_{OPR}}$			±100		ppm/°C	②
CE "High" Voltage	V _{CEH}		1.2			V	②
CE "Low" Voltage	V _{CEL}				0.3	V	③
CE "High" Current	I _{CEH}	V _{IN} = V _{CE} = 16 V	-0.1		0.1	μA	①
CE "Low" Current	I _{CEL}	V _{IN} = 16 V, V _{CE} = 0 V	-0.1		0.1	μA	①
FB "High" Current	I _{FBH}	V _{IN} = V _{CE} = 16 V	-0.1		0.1	μA	④
FB "Low" Current	I _{FBL}	V _{IN} = 16 V, V _{CE} = 0 V	-0.1		0.1	μA	④

NOTE:

*1: EFF1 = {(output voltage) x (output current)} / {(input voltage) x (input current)} x 100

*2: No Integral protection function is available with the IXD3220/221 C series.

** Refer to the CHARACTERISTICS CHART BY OSCILLATION FREQUENCY

ELECTRICAL OPERATING CHARACTERISTICS (Continued)

IXD3220/221 B and D versions

Unless otherwise specified, $V_{IN} = 5\text{ V}$, $T_a = 25\text{ }^\circ\text{C}$

PARAMETER	SYMBOL	CONDITIONS	MIN.	TYP.	MAX.	UNIT	CIRCUIT
FB Voltage	V_{FB}		0.8865	0.9000	0.9135	V	②
Input Voltage Range	V_{IN}		2.8	-	16.0	V	
UVLO Voltage (Minimum Operating Voltage)	V_{UVLO}		1.9	2.3	2.7	V	③
Supply Current 2	I_{DD2}	$V_{IN} = 5.0\text{ V}$, $V_{FB} = 1.0\text{ V}$		**		μA	①
Standby Current	I_{STB}			0.1	1	μA	①
Oscillation Frequency	f_{OSC}	Connected to external components		**		kHz	③
Maximum Duty Cycle Ratio	D_{MAX}		100	-	-	%	②
PFM Duty Cycle Ratio	D_{PFM}	No load IXD3221 series only	15	25	35	%	③
EXT "H" ON Resistance	R_{EXTH}		6	10	16	Ω	④
EXT "L" ON Resistance	R_{EXTL}		6	12	20	Ω	④
Integral Protection Time (*4)	t_{PRO}	IXD3220/221 B series		**		ms	②
Short-Circuit Protection	V_{SHRT}				0.7	V	②
Soft-Start Time	t_{SS}	Connected to R_{SS} and C_{SS}	5.0	10.0	20.0	ms	⑤
Internal Soft-Start Time (*1)	t_{SS_INT}			**		ms	②
Efficiency (*2)	EFF1			92		%	③
FB Voltage Temperature Characteristics	$\frac{\Delta V_{FB}}{V_{FB} * \Delta t_{OPR}}$			± 100		ppm/ $^\circ\text{C}$	②
CE "High" Voltage (*3)	V_{CEH}		2.6			V	②
CE "Low" Voltage	V_{CEL}				0.3	V	②
CE "High" Current	I_{CEH}	$V_{IN} = V_{CE} = 16\text{ V}$	-0.1		0.1	μA	①
CE "Low" Current	I_{CEL}	$V_{IN} = 16\text{ V}$, $V_{CE} = 0\text{ V}$	-0.1		0.1	μA	①
FB "High" Current	I_{FBH}	$V_{IN} = V_{CE} = 16\text{ V}$	-0.1		0.1	μA	④
FB "Low" Current	I_{FBL}	$V_{IN} = 16\text{ V}$, $V_{CE} = 0\text{ V}$	-0.1		0.1	μA	④

NOTE:

External Components: $C_{SS} = 0.1\text{ }\mu\text{F}$, $R_{SS} = 200\text{ k}\Omega$

*1 - In case where the UVLO function operates temporarily due to the power cutoff etc., when an external C_{SS} is charged ($V_{CE} > 2.6\text{ V}$), the IC restarts operation by the internal soft-start time. Minimum value of soft-start time set externally is equal to the internal soft-start time.

*2: $EFF1 = \{(\text{output voltage}) \times (\text{output current})\} / \{(\text{input voltage}) \times (\text{input current})\} \times 100$

*3: The integral latch and short-circuit protection do not function when the CE/ C_{SS} pin voltage is lower than 2.6 V during the soft-start time.

*4: No Integral protection function is available with the IXD3220/221 D series.

** Refer to the CHARACTERISTICS CHART BY OSCILLATION FREQUENCY.

CHARACTERISTICS CHART BY OSCILLATION FREQUENCY

PARAMETER	SYMBOL	300kHz			500kHz			1.0MHz			UNITS
		MIN.	TYP.	MAX.	MIN.	TYP.	MAX.	MIN.	TYP.	MAX.	
Supply Current 2	I_{DD2}	-	25	50	-	25	50	-	40	80	μA
Oscillation Frequency	f_{OSC}	255	300	345	425	500	575	850	1000	1150	kHz
Integral Protection Time	t_{PRO}	0.5	1.0	2.0	0.5	1.0	2.0	0.25	0.50	1.00	ms
Soft-Start Time	t_{SS}	2	3	8	2	4	8	1	2	4	ms

PIN CONFIGURATION

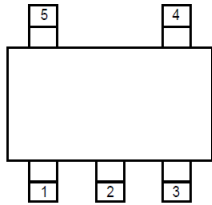

SOT-25
(TOP VIEW)

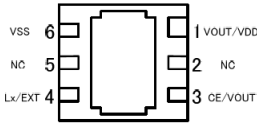

USP-6C (BOTTOM VIEW)

The dissipation pad for the USP-6C package should be solder-plated in recommended mount pattern and metal masking to enhance mounting strength and heat release. If the pad

PIN ASSIGNMENT

PIN NUMBER		PIN NAME	FUNCTIONS
SOT-25	USP-6C		
1	6	CE/C _{SS}	Chip Enable/Soft Start (Logic High – IC operating, Logic Low – IC in Off State)
2	5	V _{SS}	Ground
3	4	FB	Output Voltage Sense
4	3	EXT	External Transistor Drive
-	2	NC	No Connection
5	1	V _{IN}	Power Supply

BLOCK DIAGRAMS

IXD3220/221 A and C versions

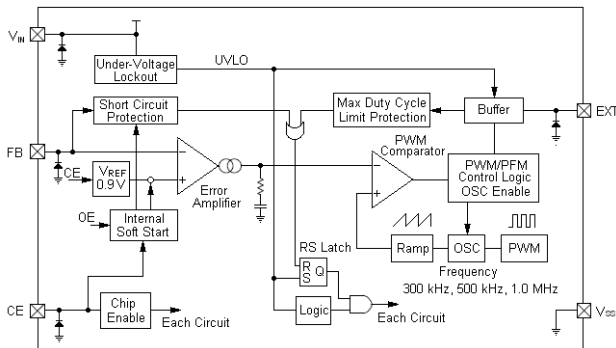

IXD3220/221 B and D versions

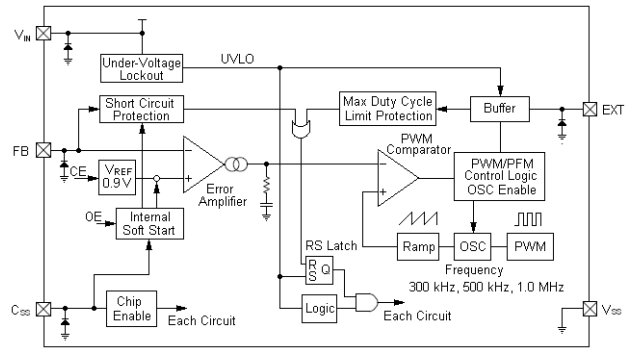

BASIC OPERATION

The IXD3220/221 series ICs contain a reference voltage source, ramp wave circuit, error amplifier, PWM comparator, phase compensation circuit, protection circuits, UVLO circuit, and others. IC's error amplifier compares the internal reference voltage with the feedback voltage from the V_{OUT} pin divided by external resistive divider. Phase compensated signal from error amplifier's output applies to the inverting PWM comparator's input, which non-inverting input is connected to the output of the ramp wave circuit. Resulting PWM modulated signal from comparator determines turn-on time. It applies to the buffer, which drives gate of the external MOSFET. This process performs continuously to ensure stable output voltage by changing duty cycle of PWM pulses in respect to error signal.

Reference Voltage Source

The reference voltage source provides the reference voltage to ensure stable output voltage of the DC/DC converter.

Oscillator

The oscillator determines fixed switching frequency, which can be selected from 300 kHz, 500 kHz, and 1.0 MHz. Clock pulses generated in this circuit are used to produce ramp waveforms needed for PWM operation, and to synchronize all internal circuits.

Error Amplifier

The error amplifier compares reference voltage with the FB pin voltage. When a feedback voltage is lower than the reference voltage, output voltage increases, resulting in longer ON time of the switching MOSFET.

The gain and frequency characteristics of the error amplifier are set internally to deliver an optimized signal to the PWM comparator.

Control Methods

The IXD3220 series ICs utilize PWM control, while the IXD3221 series ICs use either PWM or PFM control automatically changing mode.

The IXD3220 series ICs provide a constant switching frequency disregard to load. When a switching frequency noise is a concern, it is easy to filter it, since the frequency is fixed. However, the efficiency at light load may fall.

The IXD3221 series IC provide high efficiency at wide range of load, using PFM mode at light and PWM mode at heavy load, automatically changing mode.

If inductor current becomes discontinuous at light load and duty cycle intends to be less than 25%, the IXD3221 switches to PFM mode with duty cycle fixed at 25%. It increases efficiency at light load, but switching frequency at this mode depends on load. If noise at switching frequency is a concern, filtering circuitry should be designed for full specter of switching frequency.

UVLO (Under Voltage Lock Out)

When the input voltage falls to 2.3 V or lower, UVLO circuitry becomes active. It forces external P-channel MOSFET in OFF state and resets internal circuitry. When input voltage restores above UVLO value, IC resumes normal operation with internal soft start (disregard to the existence of the external soft start circuitry at IXD3220/221B and D versions)

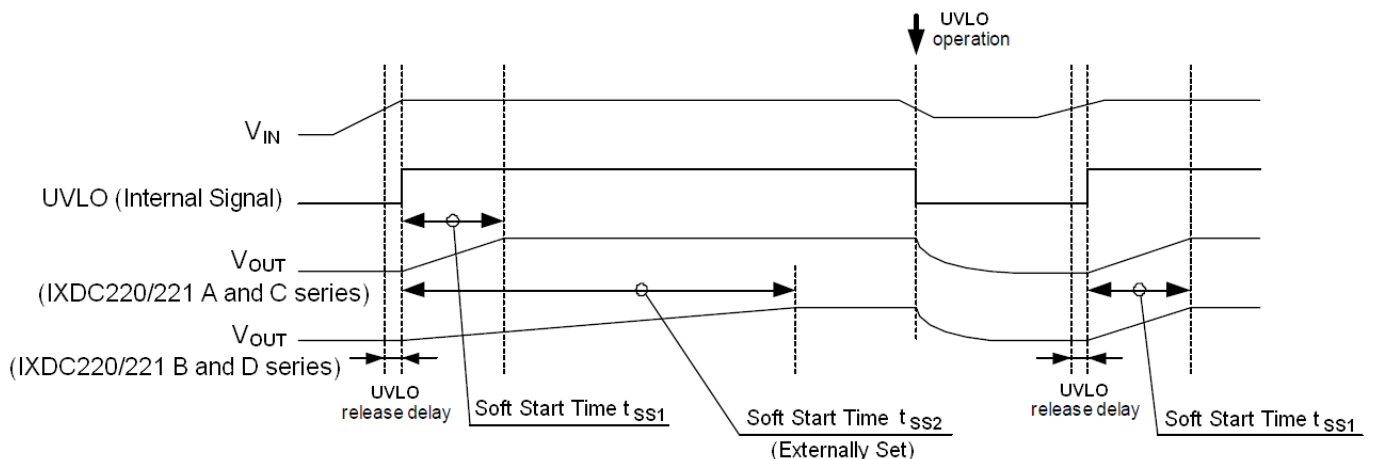

Soft-Start Time

The IXD3220/221B and D series can adjust the soft-start time externally via the CE pin. The soft-start function operates until the CE pin voltage rises above 2.6 V. Please refer to the following equation for calculating the soft-start time.

$$T_{SS} = -C_{SS} \times R_{SS} \times \ln \left\{ \frac{V_{CE} - 2.2}{V_{CE}} \right\}$$

Minimum soft-start time is equal to the time set internally.

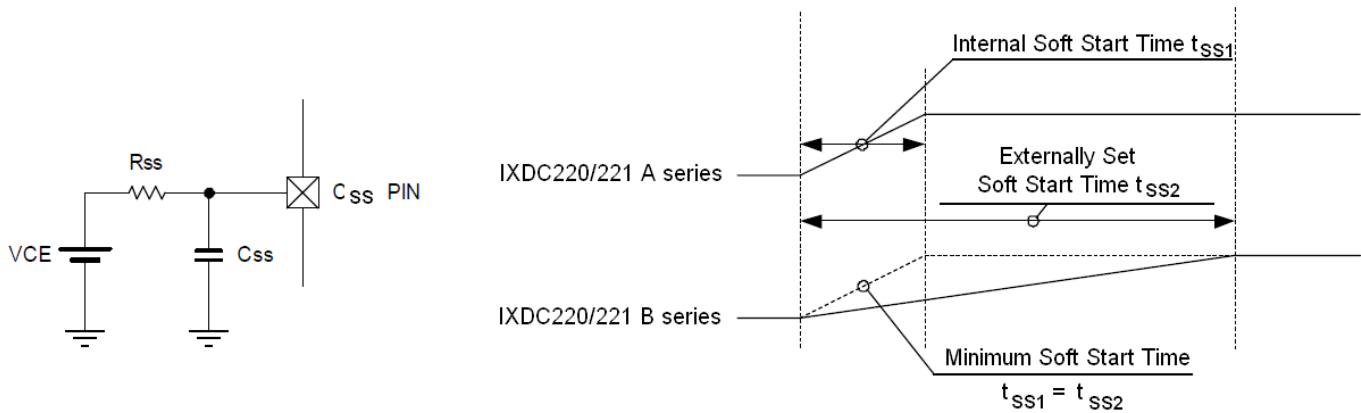

Circuit Example 1
N-channel Open Drain

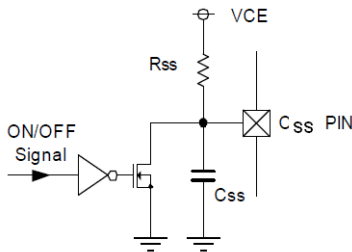

Circuit Example 2
CMOS logic (low current dissipation)

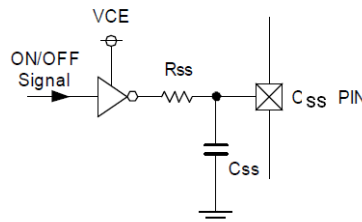

Circuit Example 3
CMOS logic (low current dissipation, quick off)

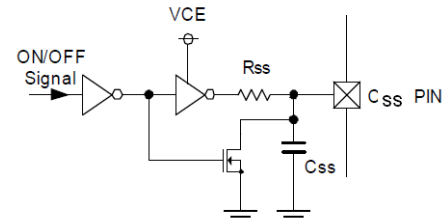

Protection Circuits

Integral Protection Circuit (Latching Type)

The IXD3220/221 A and B series utilize integral protection circuitry, which monitors maximum duty cycle. If at high load duty cycle exceeds D_{MAX} value longer than t_{PRO} time window, EXT pin latches in high state disabling external P-channel MOSFET.

To resume normal IC operation either V_{IN} or CE pins should be toggled to restart IC through soft start.

The latching state does not mean a complete shutdown, but a state in which pulse output is suspended; therefore, the internal circuitry remains in operation.

If duty cycle may exceed D_{MAX} value due normal variations in load, IXD3220/221 C and D versions without integral protection circuitry are recommended.

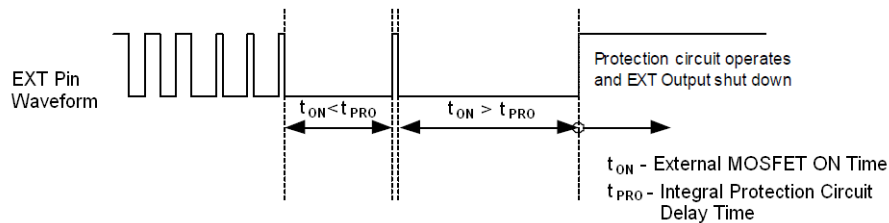

Short-Circuit Protection Circuit (Latching Type)

When the FB pin is shorted to the Ground or the output voltage drops rapidly because of overload, EXT pin latches in high state disabling external P-channel MOSFET, as in the case with the integral protection circuit. The protection circuit operates when FB voltage becomes 0.7 V or lower. To resume normal IC operation either V_{IN} or CE pins should be toggled to restart IC through soft start.

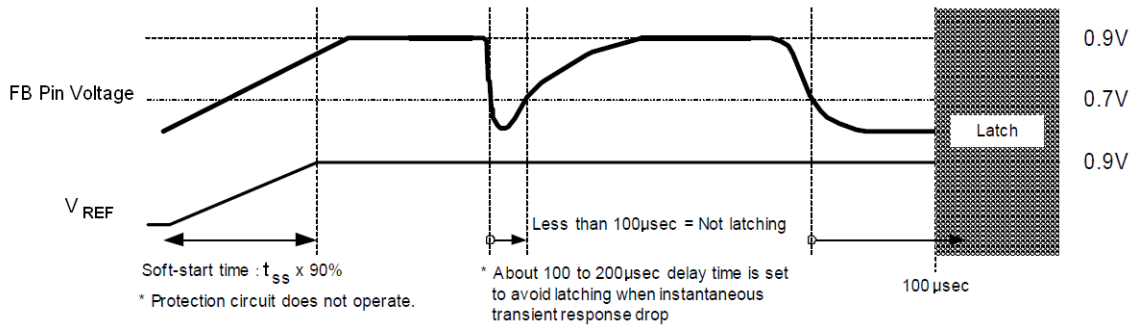

Output Voltage Setting

External resistive divider can set output voltage as $V_{OUT} = 0.9 \times (R_{FB1} + R_{FB2}) / R_{FB2}$, where R_{FB1} and R_{FB2} are values of divider resistors. The sum of R_{FB1} and R_{FB2} should be 1MΩ or less.

The value of C_{FB} , speed-up capacitor for phase compensation, is equal $C_{FB} = 1 / (2\pi \times R_{FB1} \times f_{ZFB})$, where f_{ZFB} is usually 5 kHz. However, some adjustments from 1 kHz to 20 kHz may require depending on the application, value of the inductance (L), and output capacitor (C_L).

Example: Setting 3.3 V V_{OUT}

$$R_{FB1} = 200 \text{ k}\Omega, R_{FB2} = 75 \text{ k}\Omega, V_{OUT} = 0.9 \times (200 \text{ k} + 75 \text{ k}) / 75 \text{ k} = 3.300 \text{ V}$$

$$C_{FB} = 1 / (2\pi \times 200 \text{ k} \times 5 \text{ k}) = 150 \text{ pF}$$

Typical examples

V_{OUT} , (V)	R_{FB1} , (kΩ)	R_{FB2} , (kΩ)	C_{FB} , (pF)	V_{OUT} , (V)	R_{FB1} , (kΩ)	R_{FB2} , (kΩ)	C_{FB} , (pF)
1.2	100	300	330	3.3	200	75	150
1.5	180	270	180	5.0	150	33	220
1.8	220	220	150	12.0	160	13	180

TYPICAL APPLICATION CIRCUIT

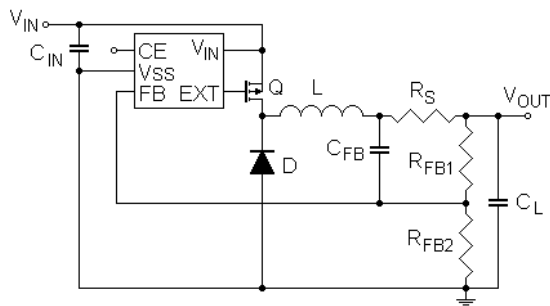

External Components

Q - P-channel MOSFET: 2SJ646 (SANYO)

D - DE5PC3 (SHINDENGEN)

L - CDRH8D28-4R7 (4.7µH, SUMIDA / fosc=1.0MHz)

CDRH8D43-100 (10µH, SUMIDA / fosc=500kHz)

CDRH127-220 (22µH, SUMIDA / fosc=300kHz)

C_{IN} - 22 µF (ceramic)

C_L - 22 µF (ceramic / fosc = 1.0 MHz, 500kHz)

47µF (ceramic / fosc = 300 kHz)

R_{SENSE} - 100 mΩ ($V_{OUT} < 2.5 \text{ V}$)

50 mΩ ($V_{OUT} > 2.5 \text{ V}$)

EXTERNAL COMPONENTS

Recommended MOSFETs and Diodes (Examples)

I_{OUT}	Up to 500 mA	Up to 1 A	Up to 2 A	Up to 3 A
P-channel MOSFET (*1)	CPH3308 (SANYO)		2SJ616 (SANYO)	2SJ646 (SANYO)
Schottky Barrier Diode (*2)	XB01SB04A2BR (TOREX)	D1FH3 (SHINDENGEN)	CMS02 (TOSHIBA)	DE5PC3 (SHINDENGEN)

*1: Recommended to use P-channel MOSFET with C_{iss} less than 1500 pF

*2: Diode should be used with high-toned reverse characteristics

Use of Ceramic Capacitors

With the IXD3220/221 series, a ceramic capacitor can be used as an output capacitor (C_L). R_{SENSE} resistor is required for using the ceramic capacitor. The value of R_{SENSE} resistor is determined depending on the setting output voltage shown in the table below.

OUTPUT VOLTAGE	R _{SENSE} (mΩ)
V _{OUT} < 2.5 V	100
V _{OUT} > 2.5 V	50

Selecting Inductor

Recommended inductance by oscillation frequency is shown in the chart below.

f _{OSC} , kHz	L, μH
300	22
500	10
1000	4.7

It is recommended to increase inductance at high load to reduce inductance peak current and improve system stability.

$I_{PK_AC} = (V_{IN} - V_{OUT}) \times V_{OUT} / (V_{IN} \times L \times f_{OSC})$, where L is an inductance value, and f_{OSC} is an oscillation frequency. Inductor peak current should not exceed the coil rating. Inductor peak current is equal

$$I_{PK} = I_{OUT} + I_{PK_AC} / 2$$

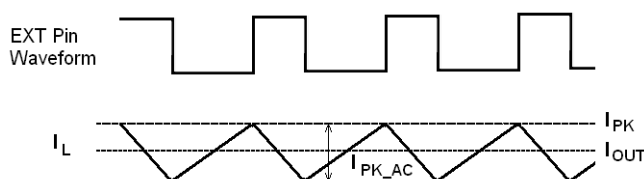

LAYOUT AND USE CONSIDERATIONS

1. Wire external components as close to the IC as possible and use thick, short connecting traces to reduce the circuit impedance.
2. Please, pay special attention to the strengthening of VIN and VSS wiring. Switching noise, which occurs from the GND, may cause the instability of the IC. For that matter, it is recommended to connect R_{IN} (about 10 Ω) and C_{DD} (about 1 μF) to the V_{IN} pin if V_{IN} voltage is high and noise is high.
3. The IXD3220/221 series are designed to work with ceramic output capacitors. However, the significant difference between input and output voltages may require capacitors with high capacitance unavailable in ceramic. We recommend use of tantalum or aluminum capacitors instead to avoid oscillation due low output capacitance.
4. EMI and output ripple voltage of switching regulators greatly influenced by external components, such as the inductors, capacitors, diodes, as well as board layout. Completed design with actual components should be verified, if it matches requirements.
5. At the significant difference between input and output voltages and light load, IC with PWM mode only, may generate very narrow pulses at EXT pin, and there is the possibility that some cycles will be skipped completely.
6. At the low difference between input and output voltages and heavy load, IC may generate very wide pulses, and there is the possibility that some cycles will be skipped completely.
7. If IXD3220/221 series are used with the CE pin pulled up to the V_{IN}, please, pay attention to the rising time of the V_{IN} voltage. If the rising time of the V_{IN} voltage is much slower than the internal soft-start time, the short circuit protection may start operate, disabling output, earlier than V_{IN} voltage stabilizes. If you are using the A or the C series, please, use a voltage detector or something similar to check that the input voltage rises fully. Then, start the IC via the CE pin. If you do not want to use an additional detector in this way, we recommend use of the B or D series, adjusting the soft-start period externally, so that the V_{IN} voltage rises fully before the soft-start is completed.
8. Use of the IC at voltages below the recommended minimum operating voltage may lead to instability.
9. Transitional voltage drop or voltage rising may create IC malfunction, sending AC in latch up mode, if ratings are exceeded,

TEST CIRCUITS

Circuit ①

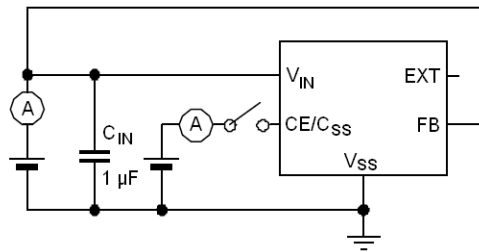

Circuit ②

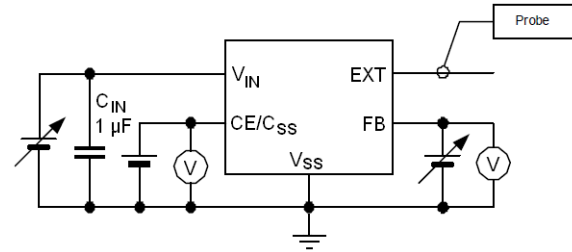

Circuit ③

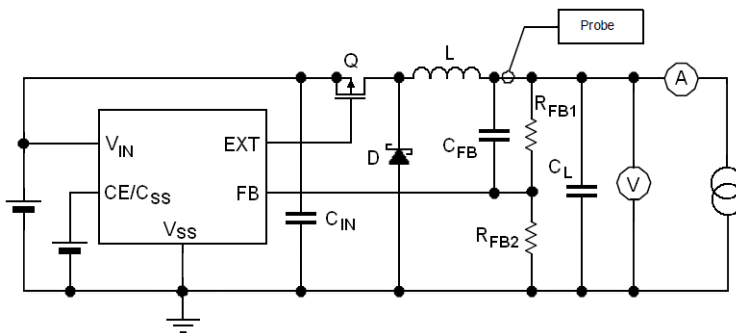

Circuit ④

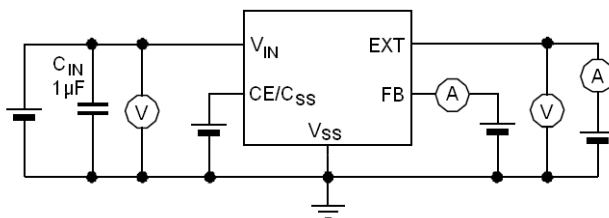

Circuit ⑤

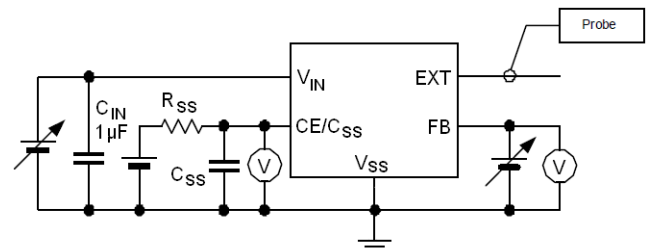

External Components

Circuit ①

$C_{IN} = 1 \mu\text{F}$, 16V (Ceramic)

Circuit ②

$C_{IN} = 1 \mu\text{F}$, 16V (Ceramic)

Circuit ③

$C_{IN} = 47 \mu\text{F}$, 16V (Tantalum)

$C_L = 47 \mu\text{F}$, 16V (Tantalum)

$L = 4.7 \mu\text{H}$ at $f_{OSC} = 1000 \text{ kHz}$

$L = 10 \mu\text{H}$ at $f_{OSC} = 500 \text{ kHz}$

$L = 22 \mu\text{H}$ at $f_{OSC} = 300 \text{ kHz}$

TYPICAL PERFORMANCE CHARACTERISTICS

(1) Efficiency vs. Output Current

$T_{opr} = 25^{\circ}C$

IXD3220/21x095xx

Q - 2SJ646, D - DE5PC3, L - CDRH127 - 10 μ H, $C_{IN} = 10 \mu F$ (ceramic), $C_L = 47 \mu F$ (ceramic), $R_{SENSE} = 50 m\Omega$, $V_{IN} = 12 V$, $V_{OUT} = 5 V$

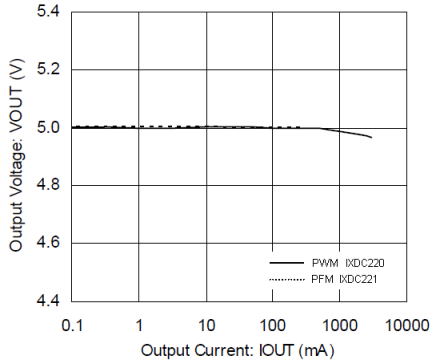

IXD3220/21x095xx

Q - 2SJ646, D - DE5PC3, L - CDRH127 - 10 μ H, $C_{IN} = 10 \mu F$ (ceramic), $C_L = 47 \mu F$ (ceramic), $R_{SENSE} = 50 m\Omega$, $V_{OUT} = 3.3 V$

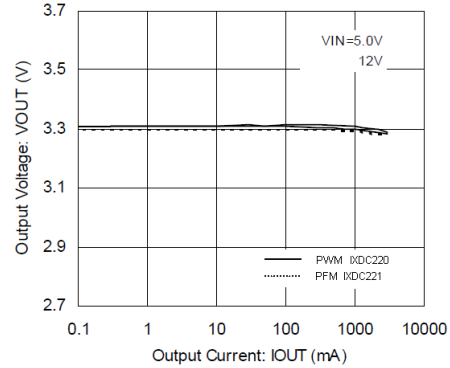

(2) Output Voltage vs. Output Current

IXD3220/21x095xx

Q - 2SJ646, D - DE5PC3, L - CDRH127 - 10 μ H, $C_{IN} = 10 \mu F$ (ceramic), $C_L = 47 \mu F$ (ceramic), $R_{SENSE} = 50 m\Omega$, $V_{IN} = 12 V$, $V_{OUT} = 5 V$

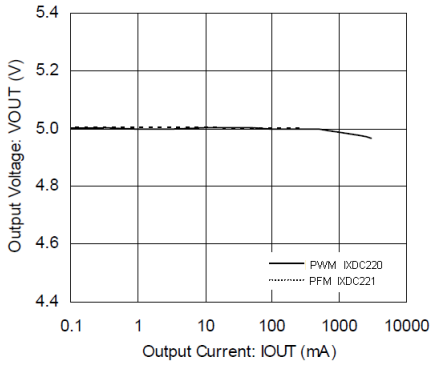

IXD3220/21x095xx

Q - 2SJ646, D - DE5PC3, L - CDRH127 - 10 μ H, $C_{IN} = 10 \mu F$ (ceramic), $C_L = 47 \mu F$ (ceramic), $R_{SENSE} = 50 m\Omega$, $V_{OUT} = 3.3 V$

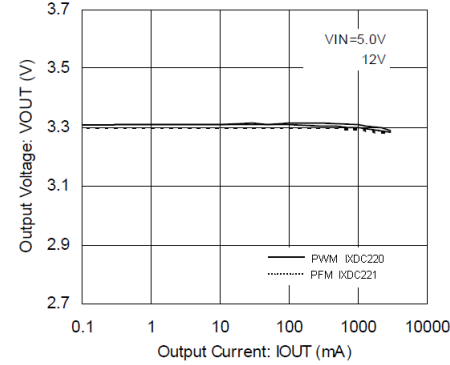

(3) Output Ripple Voltage vs. Output Current

IXD3220/21x095xx

Q - 2SJ646, D - DE5PC3, L - CDRH127 - 10 μ H, $C_{IN} = 10 \mu F$ (ceramic), $C_L = 47 \mu F$ (ceramic), $R_{SENSE} = 50 m\Omega$, $V_{IN} = 12 V$, $V_{OUT} = 5 V$

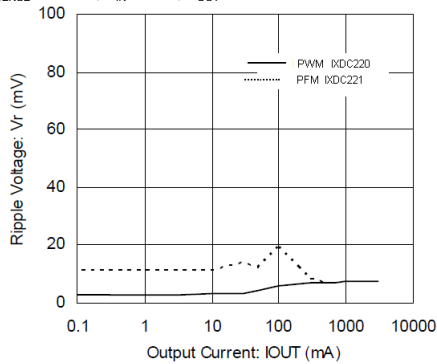

IXD3220/21x095xx

Q - 2SJ646, D - DE5PC3, L - CDRH127 - 10 μ H, $C_{IN} = 10 \mu F$ (ceramic), $C_L = 47 \mu F$ (ceramic), $R_{SENSE} = 50 m\Omega$, $V_{OUT} = 3.3 V$

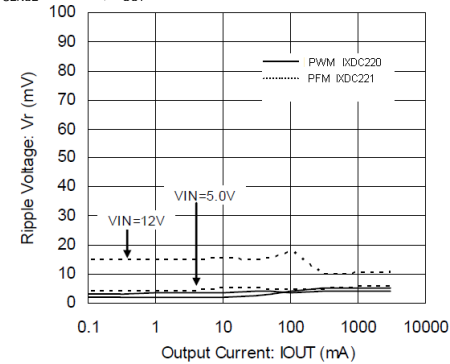

TYPICAL PERFORMANCE CHARACTERISTICS (Continued)

(4) FB Voltage Temperature Characteristics

IXD3220/221 Series

$V_{IN} = 5\text{ V}$

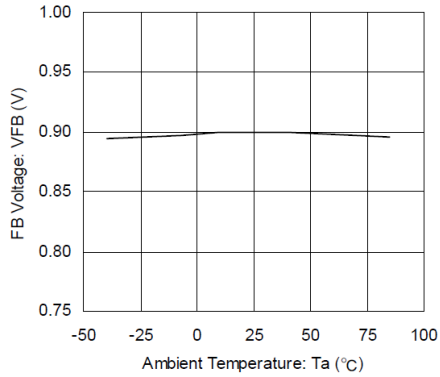

(5) FB Voltage vs. Input Voltage

IXD3220/221 Series

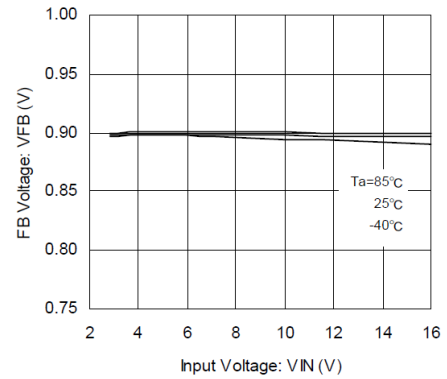

(6) Input Voltage Temperature Characteristics

IXD3220/221 Series

$V_{IN} = 5\text{ V}$, $f_{OSC} = 300\text{ kHz}$, 500 kHz

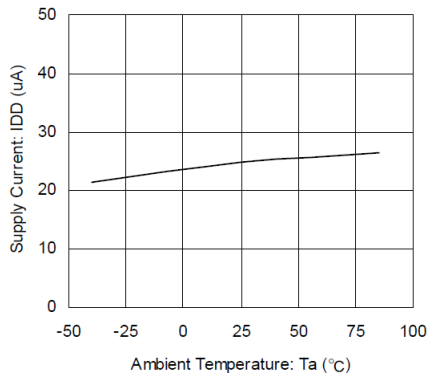

(7) Supply Current vs. Input Voltage

IXD3220/221 Series

$f_{OSC} = 300\text{ kHz}$, 500 kHz

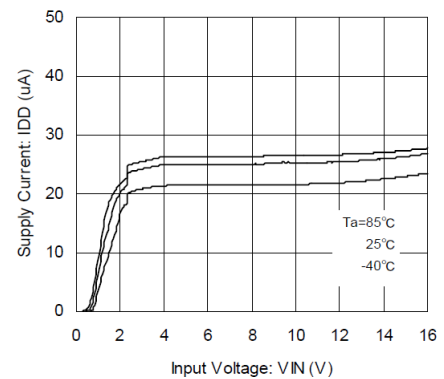

(8) Oscillation Frequency Temperature Characteristics

IXD3220/221x095xx

$V_{IN} = 5\text{ V}$

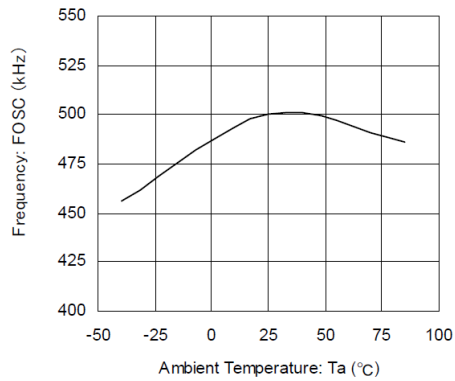

(9) UVLO Temperature Characteristics

IXD3220/221 Series

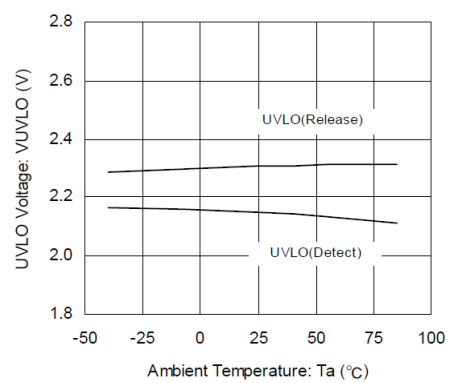

TYPICAL PERFORMANCE CHARACTERISTICS (Continued)

(10) EXT “H” ON Resistance Characteristics

IXD3220/221 Series

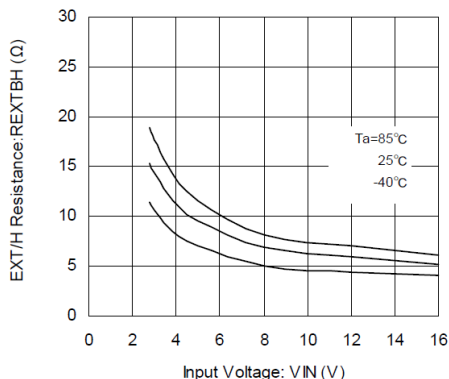

(11) EXT “L” ON Resistance Characteristics

IXD3220/221 Series

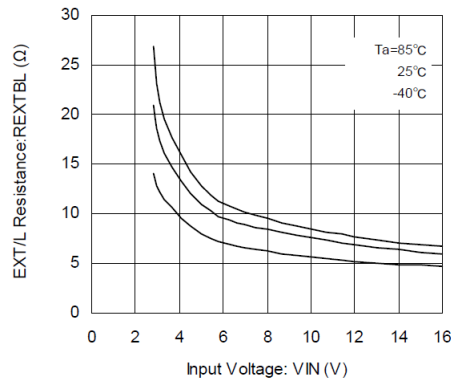

(12) Soft-Start Time Temperature Characteristics

IXD3220/221 Series

V_{IN} = 5 V, f_{OSC} = 300 kHz, 500 kHz

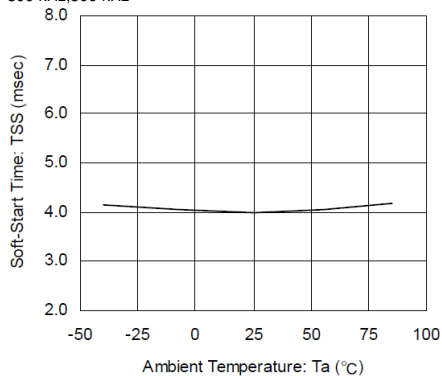

IXD3220/221 Series

V_{IN} = 5 V, f_{OSC} = 1.0 MHz

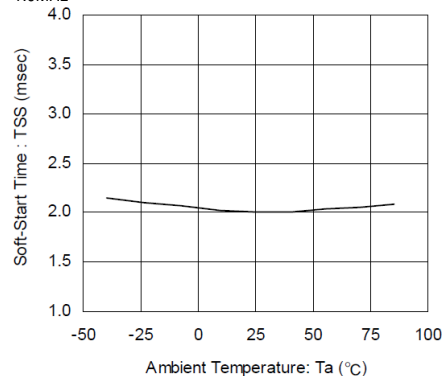

(13) Integral Protection Time Temperature Characteristics

IXD3220/21A, B Series

V_{IN} = 5 V, f_{OSC} = 300 kHz, 500 kHz

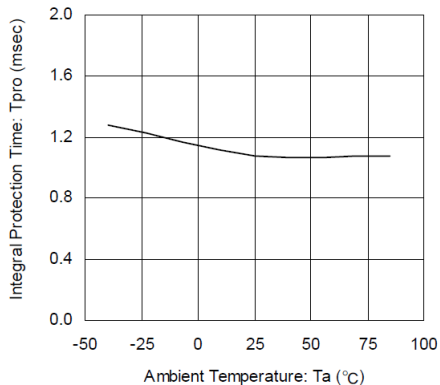

IXD3220/21A, B Series

V_{IN} = 5 V, f_{OSC} = 1.0 MHz

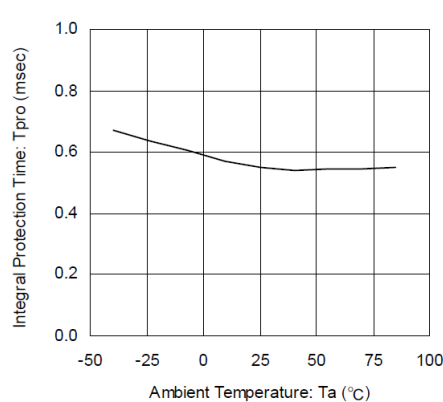

TYPICAL PERFORMANCE CHARACTERISTICS (Continued)

(14) Short-Circuit Protection Temperature Characteristics

IXD3220/221 Series
 $V_{IN} = 5\text{ V}$

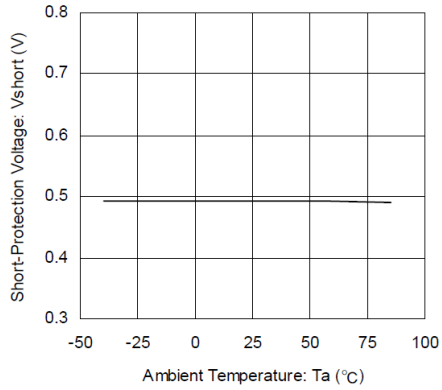

(15) Short-Circuit Protection Voltage vs. Input Voltage

IXD3220/221 Series

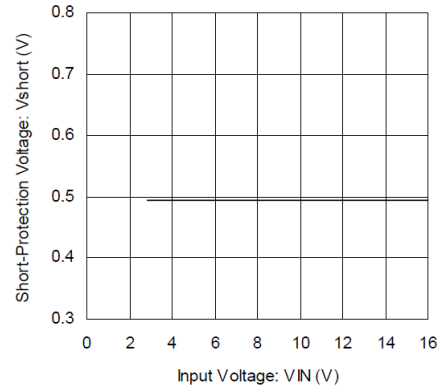

(16) CE Threshold Temperature Characteristics

IXD3220/221 Series
 $V_{IN} = 5\text{ V}$

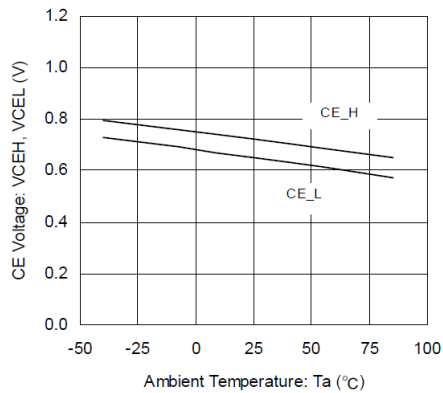

(17) CE Threshold vs. Input Voltage

IXD3220/221 Series

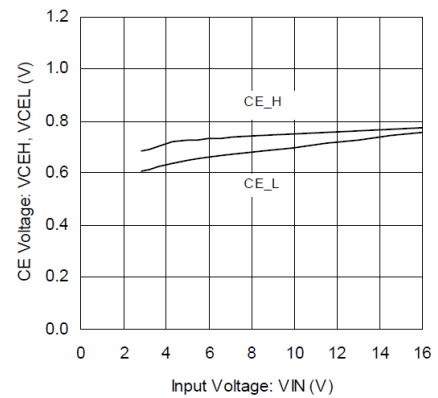

TYPICAL PERFORMANCE CHARACTERISTICS (Continued)

(18) Load Transient Response Characteristic

XC9220x095xx (500kHz, PWM Control)

Q - 2SJ616 (SANYO), D - D1FH3 (SHINDENGEN), L = 10 μ H CDRH8D43, (SUMIDA), C_{IN} = C_L = 47 μ F (OS-Con)

I_{OUT} = 0.1mA \rightarrow 1000 mA

V_{IN} = 5.0 V, V_{OUT} = 3.3 V, V_{OUT} = 100mV/div., Time = 50 μ s/div.



V_{IN} = 5.0 V, V_{OUT} = 3.3 V, V_{OUT} = 100mV/div., Time = 10 ms/div.

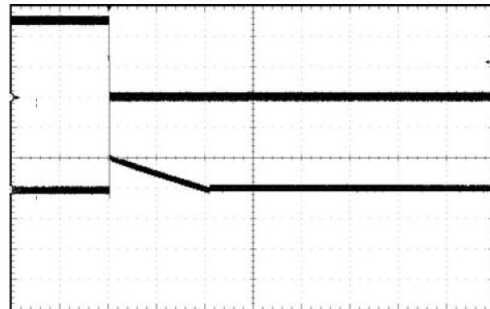

I_{OUT} = 0.1mA \rightarrow 1000 mA

V_{IN} = 10.0 V, V_{OUT} = 3.3 V, V_{OUT} = 100mV/div., Time = 50 μ s/div.

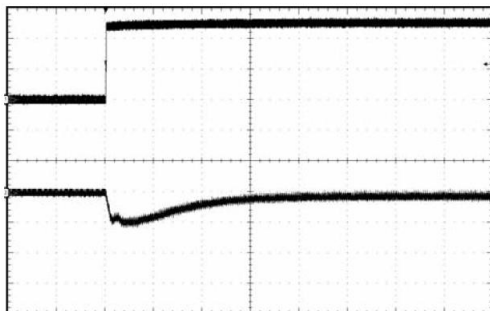

V_{IN} = 10.0 V, V_{OUT} = 3.3 V, V_{OUT} = 100mV/div., Time = 10 ms/div.

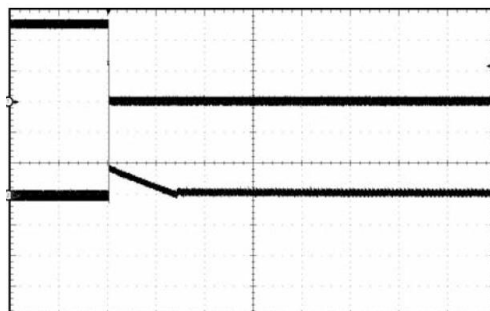

I_{OUT} = 100 mA \rightarrow 3000 mA

V_{IN} = 10.0 V, V_{OUT} = 3.3 V, V_{OUT} = 100mV/div., Time = 50 μ s/div.

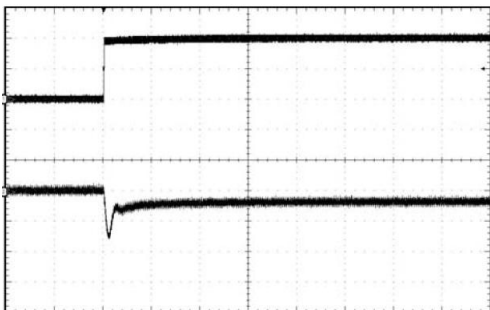

V_{IN} = 10.0 V, V_{OUT} = 3.3 V, V_{OUT} = 100mV/div., Time = 10 ms/div.

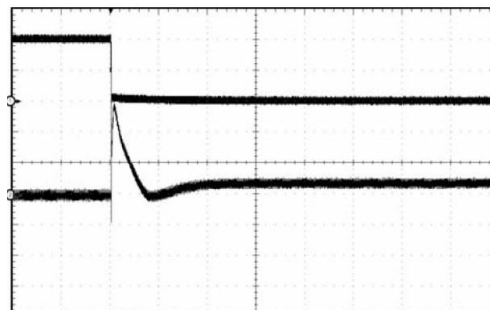

ORDERING INFORMATION

IXD3220①②③④⑤⑥-⑦ – PWM control

IXD3221①②③④⑤⑥-⑦ – PWM/PFM automatic switching control

DESIGNATOR	DESCRIPTION	SYMBOL	DESCRIPTION
①	Type of DC/DC Controller	A	Soft Start Internally Set With Integral Protection Function
		B	Soft Start Externally Set With Integral Protection Function
		C	Soft Start Internally Set Without Integral Protection Function
		D	Soft Start Externally Set Without Integral Protection Function
②③	Output Voltage	09	Feedback Voltage (Fixed)
④	Oscillation Frequency	3	300kHz
		5	500 kHz
		A	1.0 MHz
⑤⑥-⑦*	Packages (Order Limit)	MR	SOT-25 (3,000/Reel)
		MR-G	SOT-25 (3,000/Reel)
		ER	USP-6C (3,000/Reel)
		ER-G	USP-6C (3,000/Reel)

(*) The “-G” suffix denotes halogen and antimony free, as well as being fully ROHS compliant.

PRODUCT CLASSIFICATION

Product Version	A	B	C	D
Soft Start Externally Set	No	Yes	No	Yes
Integral Protection Function	Yes	Yes	No	No

PACKAGE DRAWING AND DIMENSIONS

SOT- 25

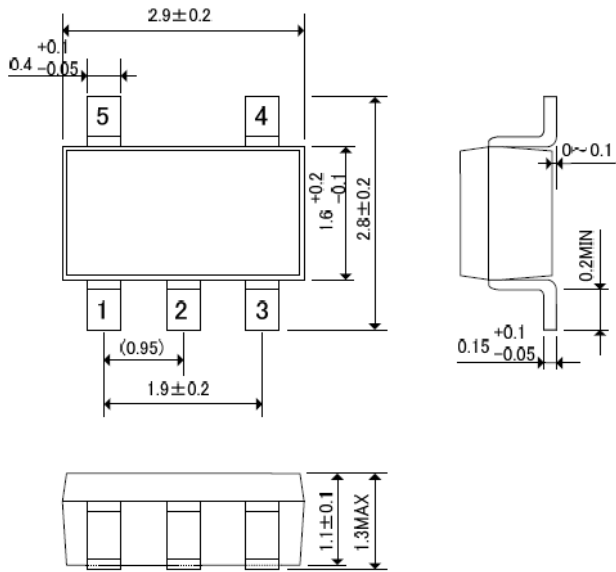

USP-6C

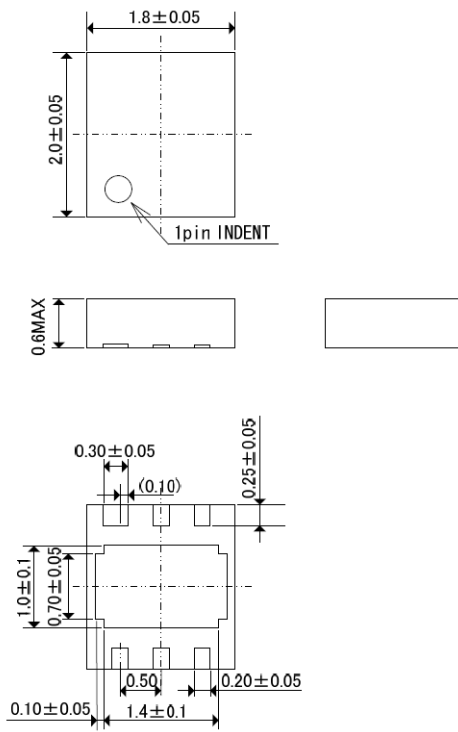

USP-6C Reference Pattern Layout

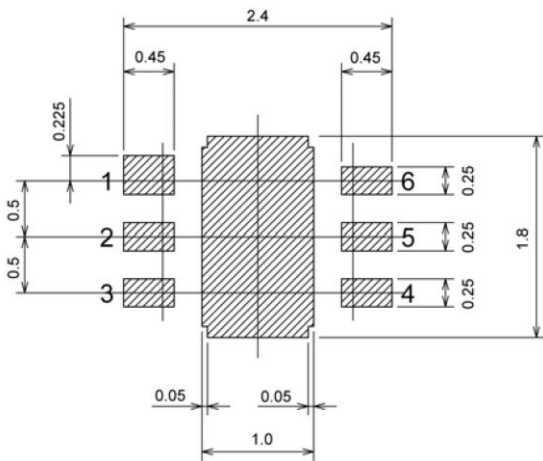

USP-6C Reference Metal Mask Design

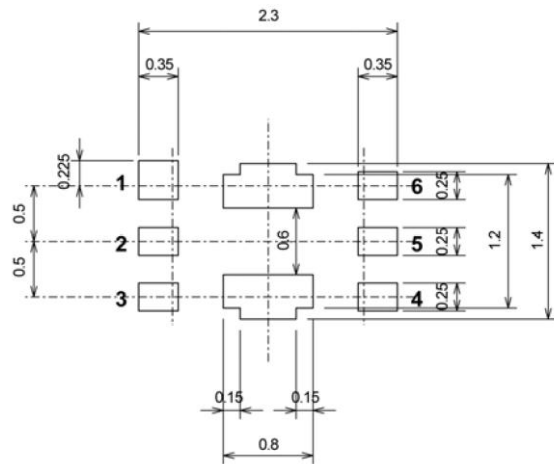

MARKING
SOT-25

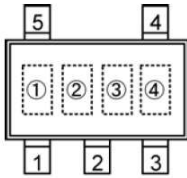

SOT-25 (TOP VIEW)

① represents product series

MARK	PRODUCT SERIES
M	IXD3220xxxxxx
N	IXD3221xxxxxx

② represents product types

MARK	FUNCTION	PRODUCT SERIES
A	Soft Start Internally Set With Integral Protection Function	IXD322xAxxxxx
B	Soft Start Externally Set With Integral Protection Function	IXD322xBxxxxx
C	Soft Start Internally Set Without Integral Protection Function	IXD322xCxxxxx
D	Soft Start Externally Set Without Integral Protection Function	IXD322xDxxxxx

③ represents oscillation frequency

MARK	OSCILLATION FREQUENCY	PRODUCT SERIES
3	300 kHz	IXD322xxx3xx
5	500 kHz	IXD322xxx5xx
A	1.0 MHz	IXD322xxxAxx

④ represents production lot number 0 to 9, A to Z repeated (G, I, J, O, Q, W excluded)

USP-6C

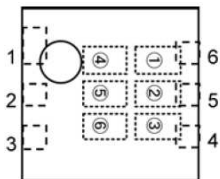

USP-6C (TOP VIEW)

① represents product series

MARK	PRODUCT SERIES
1	IXD3220xxxxxx
D	IXD3221xxxxxx

② represents product type

MARK	FUNCTION	PRODUCT SERIES
A	Soft Start Internally Set With Integral Protection Function	IXD322xAxxxxx
B	Soft Start Externally Set With Integral Protection Function	IXD322xBxxxxx
C	Soft Start Internally Set Without Integral Protection Function	IXD322xCxxxxx
D	Soft Start Externally Set Without Integral Protection Function	IXD322xDxxxxx

③④ represent FB voltage

MARK		FB VOLTAGE	PRODUCT SERIES
③	④		
0	9	0.9 V	IXD322xx09xxx

⑤ represents oscillation frequency

MARK	OSCILLATION FREQUENCY	PRODUCT SERIES
3	300 kHz	IXD322xxx3xx
5	500 kHz	IXD322xxx5xx
A	1.0 MHz	IXD322xxxAxx

⑥ represents production lot number 0 to 9, A to Z repeated (G, I, J, O, Q, W excluded)

Customer Support

To share comments, get your technical questions answered, or report issues you may be experiencing with our products, please visit Zilog's Technical Support page at <http://support.zilog.com>. To learn more about this product, find additional documentation, or to discover other facets about Zilog product offerings, please visit the Zilog Knowledge Base at <http://zillog.com/kb> or consider participating in the Zilog Forum at <http://zillog.com/forum>. This publication is subject to replacement by a later edition. To determine whether a later edition exists, please visit the Zilog website at <http://www.zilog.com>.

Warning: DO NOT USE THIS PRODUCT IN LIFE SUPPORT SYSTEMS.

LIFE SUPPORT POLICY ZILOG'S PRODUCTS ARE NOT AUTHORIZED FOR USE AS CRITICAL COMPONENTS IN LIFE SUPPORT DEVICES OR SYSTEMS WITHOUT THE EXPRESS PRIOR WRITTEN APPROVAL OF THE PRESIDENT AND GENERAL COUNSEL OF ZILOG CORPORATION.

As used herein Life support devices or systems are devices which (a) are intended for surgical implant into the body, or (b) support or sustain life and whose failure to perform when properly used in accordance with instructions for use provided in the labeling can be reasonably expected to result in a significant injury to the user. A critical component is any component in a life support device or system whose failure to perform can be reasonably expected to cause the failure of the life support device or system or to affect its safety or effectiveness.

Document Disclaimer ©2015 Zilog, Inc. All rights reserved. Information in this publication concerning the devices, applications, or technology described is intended to suggest possible uses and may be superseded. ZILOG, INC. DOES NOT ASSUME LIABILITY FOR OR PROVIDE A REPRESENTATION OF ACCURACY OF THE INFORMATION, DEVICES, OR TECHNOLOGY DESCRIBED IN THIS DOCUMENT. ZILOG ALSO DOES NOT ASSUME LIABILITY FOR INTELLECTUAL PROPERTY INFRINGEMENT RELATED IN ANY MANNER TO USE OF INFORMATION, DEVICES, OR TECHNOLOGY DESCRIBED HEREIN OR OTHERWISE. The information contained within this document has been verified according to the general principles of electrical and mechanical engineering.