



Chipsmall Limited consists of a professional team with an average of over 10 year of expertise in the distribution of electronic components. Based in Hongkong, we have already established firm and mutual-benefit business relationships with customers from,Europe,America and south Asia,supplying obsolete and hard-to-find components to meet their specific needs.

With the principle of “Quality Parts,Customers Priority,Honest Operation,and Considerate Service”,our business mainly focus on the distribution of electronic components. Line cards we deal with include Microchip,ALPS,ROHM,Xilinx,Pulse,ON,Everlight and Freescale. Main products comprise IC,Modules,Potentiometer,IC Socket,Relay,Connector.Our parts cover such applications as commercial,industrial, and automotives areas.

We are looking forward to setting up business relationship with you and hope to provide you with the best service and solution. Let us make a better world for our industry!



Contact us

Tel: +86-755-8981 8866 Fax: +86-755-8427 6832

Email & Skype: info@chipsmall.com Web: www.chipsmall.com

Address: A1208, Overseas Decoration Building, #122 Zhenhua RD., Futian, Shenzhen, China



Ultra Small, Low Power Consumption Voltage Detector

FEATURES

- Accuracy $\pm 2\%$ at $V_{DF} \geq 1.5\text{ V}$ or $\pm 0.03\text{ V}$
- Low Power Consumption at $0.6\ \mu\text{A}$ typical at $V_{DF} = 2.7\text{ V}$, $V_{IN} = 2.97\text{ V}$
- Detect Voltage Range $0.7\text{ V} - 5.0\text{ V}$ in 0.1 V increments
- Operating Voltage Range $0.7\text{ V} - 6.0\text{ V}$
- Detect Voltage Temperature Drift $\pm 100\text{ ppm}/^\circ\text{C}$
- Output Configuration CMOS (Version C) or N-channel Open Drain (N Version)
- Operating Ambient Temperature $-40 + 85^\circ\text{C}$
- Packages : USP-3 and SSOT-24
- EU RoHS Compliant, Pb Free

APPLICATIONS

- Microprocessor reset circuitry
- Memory battery back-up circuits
- Power-on reset circuits
- Power failure detection
- System battery life and charge voltage monitors

DESCRIPTION

The IXD5120 are highly precise, low power consumption, CMOS voltage detectors, manufactured using laser trimming technology.

With low power consumption and high accuracy, the series is suitable for precision mobile equipment.

The IXD5120 in ultra small packages are ideally suited for high-density PC boards.

The IXD5120 is available in both CMOS and N-channel open drain output configurations

Detector is available in USP-3 and SSOT-24 packages.

TYPICAL APPLICATION CIRCUIT

Pull-up Resistor R_{PL} used with N-channel output configuration only

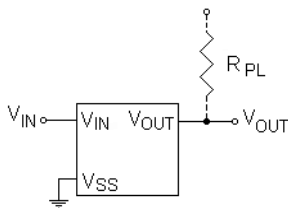

TYPICAL PERFORMANCE CHARACTERISTIC

Supply Current vs. Input Voltage
IXD5120x272xx

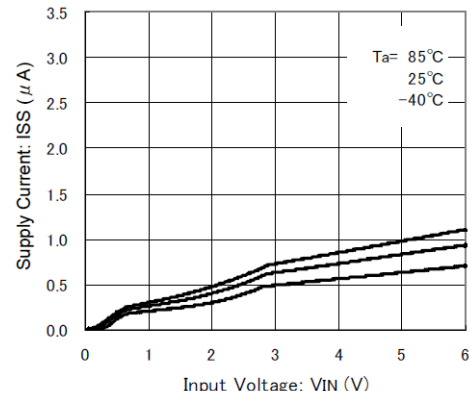

ABSOLUTE MAXIMUM RATINGS

PARAMETER		SYMBOL	RATINGS	UNITS
Input Voltage		V_{IN}	-0.3 ~ +7.0	V
Output Current		I_{OUT}	10	mA
Output Voltage	CMOS Output	V_{OUT}	-0.3 ~ $V_{IN} + 0.3$	V
	N-channel Open Drain		-0.3 ~ +7.0	V
Power Dissipation ²⁾	USP-3	P_D	120	mW
	SSOT-24		150	
Operating Temperature Range		T_{OPR}	-40 ~ +85	°C
Storage Temperature Range		T_{STG}	-55 ~ +125	°C

All voltages are in respect to V_{SS}

ELECTRICAL OPERATING CHARACTERISTICS

$T_a = 25\text{ }^\circ\text{C}$

PARAMETER	SYMBOL	CONDITIONS	MIN.	TYP.	MAX.	UNIT	CIRCUIT	
Operating Voltage	V_{IN}	$V_{DF(T)} = 1.0 - 5.0\text{ V}^{1)}$	0.7		6.0	V		
Detect Voltage	V_{DF}	$V_{DF(T)} = 1.0 - 5.0\text{ V}$		$E^{-1^{2)}$		V	①	
Hysteresis Width	V_{HYS}	$V_{DF(T)} = 1.0 - 5.0\text{ V}$	$V_{DF} \times 0.03$	$V_{DF} \times 0.05$	$V_{DF} \times 0.07$	V	①	
Supply Current1	I_{SS1}	$V_{IN} = V_{DF(T)} \times 1.1$		$E^{-2^{2)}$		μA	②	
Supply Current2	I_{SS2}	$V_{IN} = V_{DF(T)} \times 0.9$		$E^{-3^{2)}$		μA	①	
Output Current	I_{OUTN}	$V_{IN} = 0.7\text{ V}$	$V_{OUT} = 0.5\text{ V}$	0.09	0.57		mA	③
			$V_{OUT} = 0.3\text{ V}$	0.08	0.56			
			$V_{OUT} = 0.1\text{ V}$	0.05	0.30			
	$V_{IN} = 1.0\text{ V}$	$V_{OUT} = 0.1\text{ V}, 1.0\text{ V} < V_{DF(T)} \leq 2.0\text{ V}$	0.46	0.71				
	$V_{IN} = 2.0\text{ V}$	$V_{OUT} = 0.1\text{ V}, 2.0\text{ V} < V_{DF(T)} \leq 3.0\text{ V}$	1.15	1.41				
	$V_{IN} = 3.0\text{ V}$	$V_{OUT} = 0.1\text{ V}, 3.0\text{ V} < V_{DF(T)} \leq 4.0\text{ V}$	1.44	1.77				
	$I_{OUTP}^{3)}$	$V_{IN} = 6.0\text{ V}$	$V_{OUT} = 5.5\text{ V}$		-0.96	-0.60		
Leakage Current	I_{LEAK}	Version C	$V_{IN} = V_{DF(T)} \times 0.9, V_{OUT} = 0\text{ V}$		-0.001		μA	③
		Version N	$V_{IN} = 6.0\text{ V}, V_{OUT} = 6.0\text{ V}$		0.001	0.10		
Detect Voltage Temperature Characteristics	$\frac{\Delta V_{DF}}{V_{DF} * \Delta T_{OPR}}$	$-40\text{ }^\circ\text{C} \leq T_{OPR} \leq 85\text{ }^\circ\text{C}$		± 100		ppm/°C	①	
Detect Delay Time ⁴⁾	t_{DF}	$V_{IN} = 6.0\text{ V} \rightarrow 0.7\text{ V}$, from $V_{IN} = V_{DF}$ to $V_{OUT} = 0.5\text{ V}$		30	100	μs	④	
Release Delay Time ⁵⁾	t_{DR}	$V_{IN} = 0.7\text{ V} \rightarrow 6.0\text{ V}$, from $V_{IN} = V_{DR}$ to $V_{OUT} = V_{DR}^{6)}$		20	100	μs	④	

NOTE:

- $V_{DF(T)}$ is a nominal detect voltage
- Please refer to the table named Detect Voltage Accuracy and Supply Current Specifications
- IXD5120C version only
- Delay time from the moment, when $V_{IN} = V_{DF}$ to the moment, when $V_{OUT} = 0.5\text{ V}$, at V_{IN} falling from 6.0 V to 0.7 V
- Delay time from the moment, when $V_{IN} = V_{DR}$ to the moment, when $V_{OUT} = V_{DR}$
- Release voltage ($V_{DR} = V_{DF} + V_{HYS}$)

ELECTRICAL OPERATING CHARACTERISTICS (CONTINUED)

Detect Voltage Accuracy and Supply Current Specification

SYMBOL NOMINAL DETECT VOLTAGE $V_{DF(T)}$	E-1 DETECT VOLTAGE V_{DF} (V)		E-2 SUPPLY CURRENT1 I_{SS1} (μ A)		E-3 SUPPLY CURRENT2 I_{SS2} (μ A)	
	MIN.	MAX.	TYP.	MAX.	TYP.	MAX.
	1.0	0.970	1.030	0.5	1.4	0.4
1.1	1.070	1.130				
1.2	1.170	1.230				
1.3	1.270	1.330				
1.4	1.370	1.430				
1.5	1.470	1.530				
1.6	1.568	1.632				
1.7	1.666	1.734				
1.8	1.764	1.836				
1.9	1.862	1.938				
2.0	1.960	2.040	0.6	1.7	0.5	1.60
2.1	2.058	2.142				
2.2	2.156	2.244				
2.3	2.254	2.346				
2.4	2.352	2.448				
2.5	2.450	2.550				
2.6	2.548	2.652				
2.7	2.646	2.754				
2.8	2.744	2.856	0.7	1.9	0.6	1.80
2.9	2.842	2.958				
3.0	2.940	3.060				
3.1	3.038	3.162				
3.2	3.136	3.264				
3.3	3.234	3.366				
3.4	3.332	3.468				
3.5	3.430	3.570				
3.6	3.528	3.672				
3.7	3.626	3.774				
3.8	3.724	3.876				
3.9	3.822	3.978				
4.0	3.920	4.080				
4.1	4.018	4.182				
4.2	4.116	4.284				
4.3	4.214	4.386				
4.4	4.312	4.488				
4.5	4.410	4.590				
4.6	4.508	4.692				
4.7	4.606	4.794				
4.8	4.704	4.896				
4.9	4.802	4.998				
5.0	4.900	5.100				

PIN CONFIGURATION

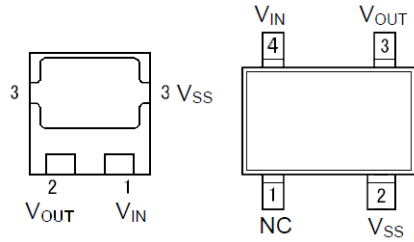

USP-3
(BOTTOM VIEW)

SSOT-24
(TOP VIEW)

PIN ASSIGNMENT

PIN NUMBER		PIN NAME	FUNCTIONS
USP-3	SSOT-24		
1	4	V_{IN}	Power Input
2	3	V_{OUT}	Output Voltage (Detect "LOW")
3	2	V_{SS}	Ground
	1	NC	No Connection

BLOCK DIAGRAM

IXD5120C

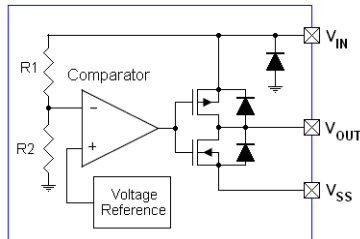

IXD5120N

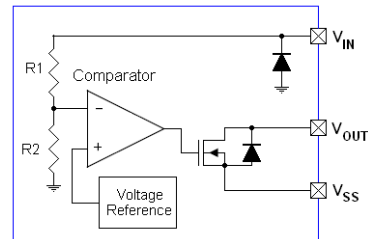

Diodes inside the circuits are ESD protection diodes and parasitic diodes.

BASIC OPERATION

Operation of the IXD5120 in a typical application circuit is explained by the timing diagram shown below.

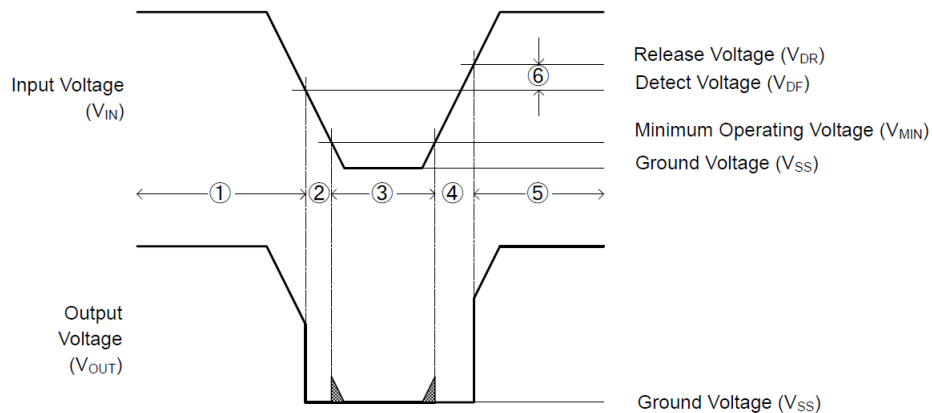

Note: To simplify explanation, an operation time of the circuit is not included.

- ① When input voltage V_{IN} is higher than detect voltage V_{DF} , output voltage V_{OUT} is equal input voltage V_{IN} . (Output of the IXD5120N version with N-channel open drain is in high impedance state.)
- ② When input voltage V_{IN} falls below detect voltage V_{DF} , output voltage V_{OUT} becomes equal to the ground voltage V_{SS} level.
- ③ When input voltage V_{IN} falls below minimum operating voltage V_{MIN} , output becomes unstable. In this condition, V_{OUT} is equal pull-up voltage, which is V_{IN} in typical application.
- ④ When input voltage V_{IN} rises above the minimum operating voltage V_{MIN} , output keeps the ground voltage level V_{SS} , until V_{IN} becomes equal or higher than a release voltage V_{DR} .
- ⑤ When the input voltage V_{IN} rises above the release voltage V_{DR} , output voltage V_{OUT} becomes equal to the input voltage V_{IN} . (Output of the IXD5120N version with N-channel open drain is in high impedance state.)
- ⑥ The difference between V_{DR} and V_{DF} represents the hysteresis width.

TYPICAL APPLICATION CIRCUIT

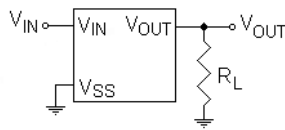

IXD5120C

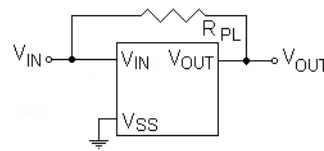

IXD5120N

LAYOUT AND USE CONSIDERATIONS

1. The IC may malfunction if absolute maximum ratings are exceeded.
2. To stabilize the IC's operations, please, ensure that V_{IN} rise and fall times are more than several $\mu\text{s}/\text{V}$.
3. IXD5120N version with N-channel open drain configuration is recommended, when a resistive divider is used to set V_{IN} voltage (see figure below). Voltage drop at resistor R_{IN} caused by supply and load currents, changes level of detect and release voltages. Those errors are not constant because of the fluctuation of currents. In addition, oscillation may occur if voltage drop caused by load or transient current exceeds hysteresis $V_{HYS} = V_{DR} - V_{DF}$. In such cases, please ensure that R_{IN} is less than 10 k Ω and that C is more than 0.1 μF .

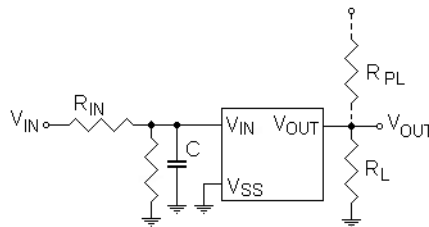

IXD5120N Recommended Pull-up Resistors Value

INPUT VOLTAGE RANGE	PULL-UP RESISTANCE
0.7V~6.0V	$\geq 220\text{k}\Omega$
0.8V~6.0V	$\geq 100\text{k}\Omega$
1.0V~6.0V	$\geq 33\text{k}\Omega$

TEST CIRCUITS

Circuit ①

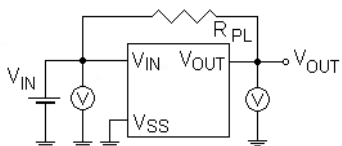

Circuit ②

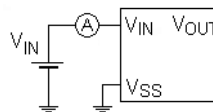

Circuit ③

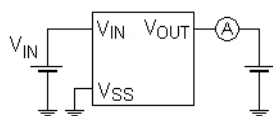

Circuit

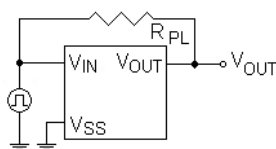

Pull-up Resistor $R_{PL} = 100\text{ k}\Omega$ is used for IXD5120N version only

TYPICAL PERFORMANCE CHARACTERISTICS

(1) Supply Current vs. Input Voltage

IXD5120x102xx

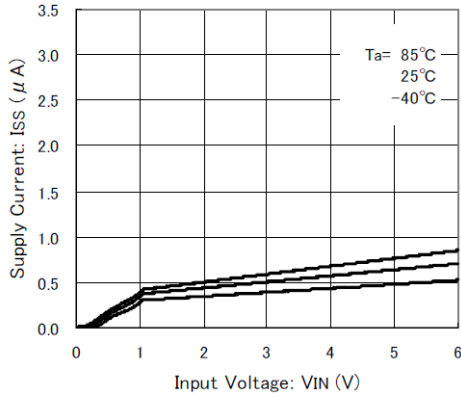

IXD5120x502xx

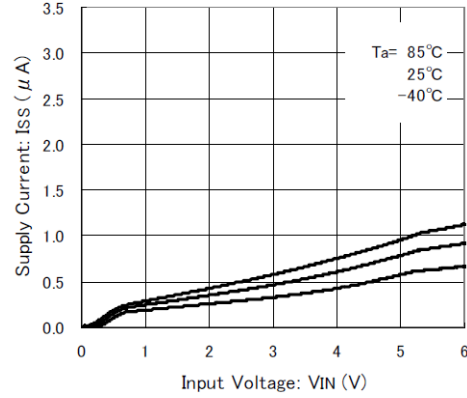

(2) Output Voltage vs. Input Voltage

IXD5120C202xx

Ta = 25°C

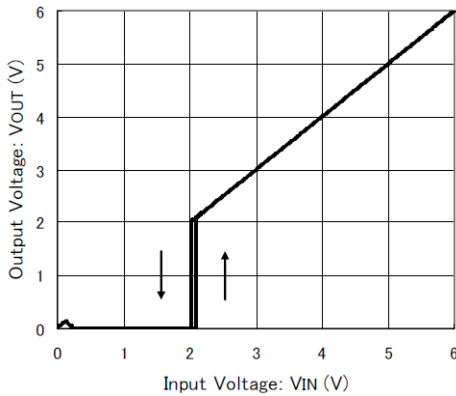

IXD5120N202xx

V_{PULL_UP} = 6.0 V, R_{PULL_UP} = 100 k Ω

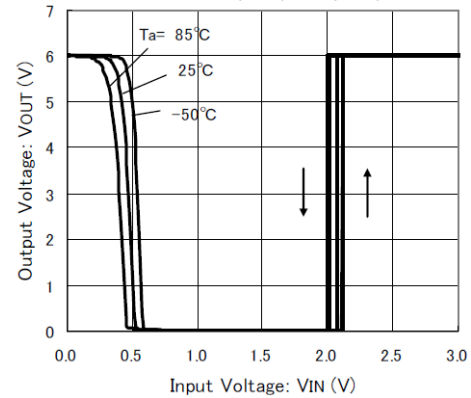

(3) Detect Voltage, Release Voltage vs. Ambient Temperature

IXD5120x102xx

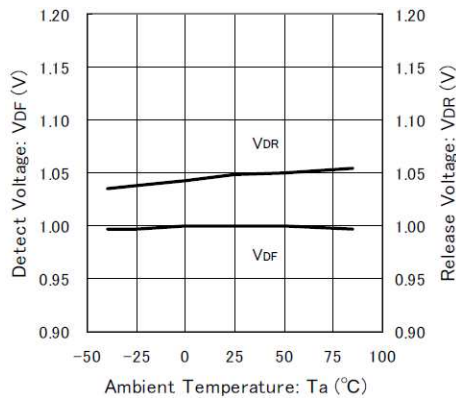

IXD5120x202xx

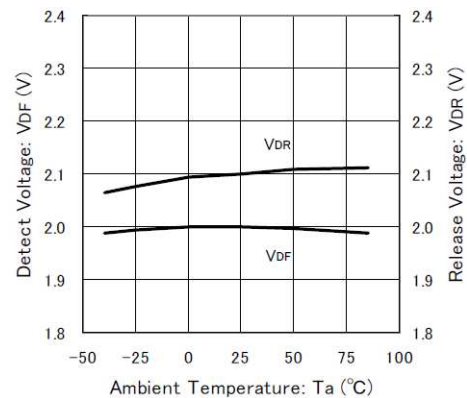

TYPICAL PERFORMANCE CHARACTERISTICS (Continued)

(4) Output Current (N-channel transistor) vs Input Voltage

IXD5120x502xx
 $V_{OUT} = 0.5\text{ V}$

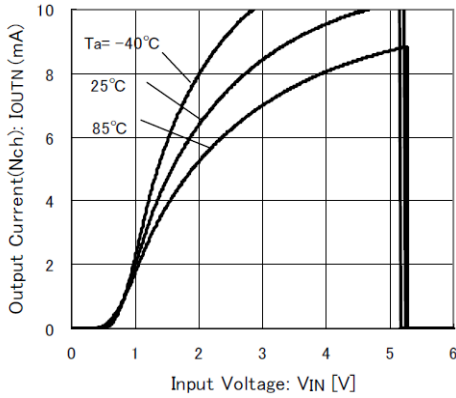

IXD5120x502xx
 $V_{OUT} = 0.3\text{ V}$

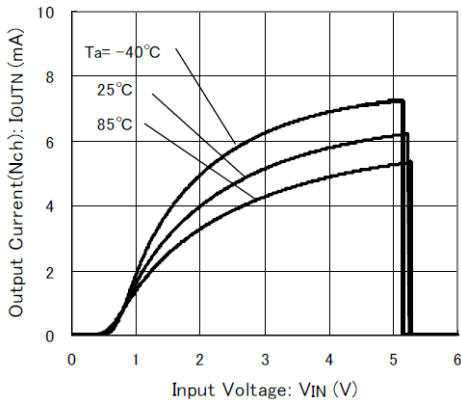

IXD5120x502xx
 $V_{OUT} = 0.1\text{ V}$

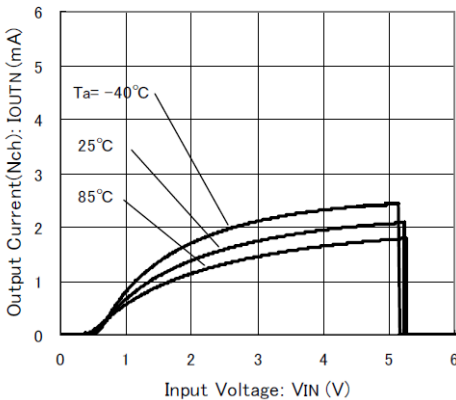

(5) Output Current (P-channel transistor) vs. Input Voltage

IXD512C102xx
 $V_{OUT} = V_{IN} - 0.5\text{ V}$

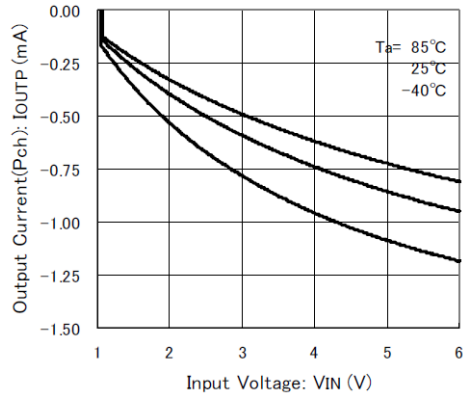

IXD512C102xx
 $V_{OUT} = V_{IN} - 0.3\text{ V}$

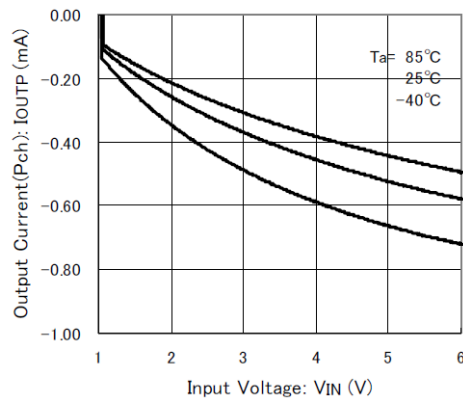

IXD512C102xx
 $V_{OUT} = V_{IN} - 0.1\text{ V}$

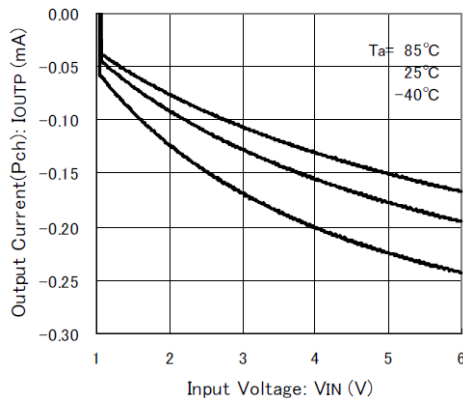

ORDERING INFORMATION

IXD5120①②③④⑤⑥-⑦

DESIGNATOR	DESCRIPTION	SYMBOL	DESCRIPTION
①	Output Configuration	C	CMOS output
		N	N-channel open drain output
②③	Detect Voltage (V_{DF})	10 - 50	Detect Voltage Range: 1.0 V ~ 5.0 V, e.g. 1.2 V - ② = 1, ③ = 2
④	Detect Threshold Accuracy	2	±2%
⑤⑥-⑦(*)	Packages (Order Unit)	HR	USP-3 (3000/Reel)
		HR-G	USP-3 (1000/Reel)
		NR	SSOT-24 (3000/Reel)
		NR-G	SSOT-24 (3000/Reel)

NOTE:

The “-G” suffix denotes Halogen and Antimony free as well as being fully RoHS compliant.

PACKAGE DRAWING AND DIMENSIONS

USP-3, Units: mm

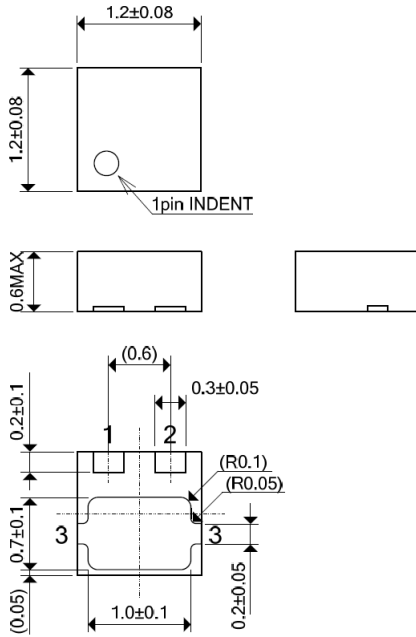

SSOT-24, Units: mm

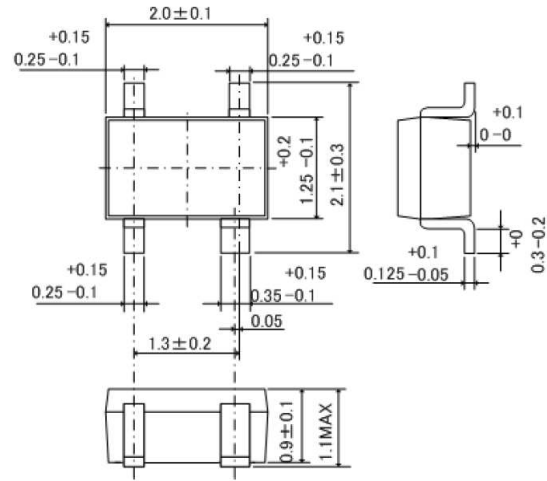

USP-3 Reference Pattern Layout, Units: mm

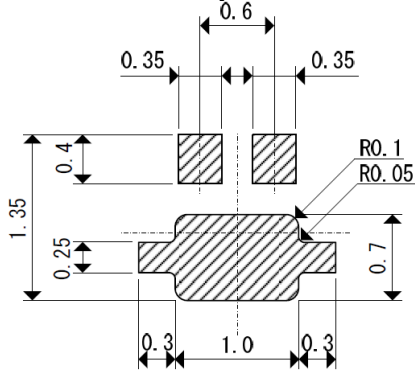

USP-3 Reference Metal Mask Design

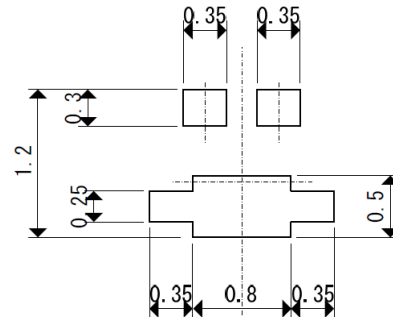

MARKING

SSOT-24

① Represents output configuration and detect voltage range

MARK	OUTPUT CONFIGURATION	OUTPUT VOLTAGE	PRODUCT SERIES
K	CMOS	1.0V~2.9V	IXD5120C
L		3.0V~5.0V	
M	N-channel open drain	1.0V~2.9V	IXD5120N
N		3.0V~5.0V	

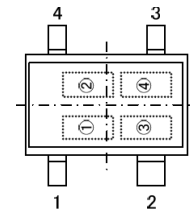

SSOT-24 (Top View)

② Represents detect voltage

MARK	DETECT VOLTAGE (V)		MARK	DETECT VOLTAGE (V)	
0	-	3.0	F	1.5	4.5
1	-	3.1	H	1.6	4.6
2	-	3.2	K	1.7	4.7
3	-	3.3	L	1.8	4.8
4	-	3.4	M	1.9	4.9
5	-	3.5	N	2.0	5.0
6	-	3.6	P	2.1	-
7	-	3.7	R	2.2	-
8	-	3.8	S	2.3	-
9	-	3.9	T	2.4	-
A	1.0	4.0	U	2.5	-
B	1.1	4.1	V	2.6	-
C	1.2	4.2	X	2.7	-
D	1.3	4.3	Y	2.8	-
E	1.4	4.4	Z	2.9	-

③④ Represents production lot number

01 to 09, 10, 11, ..., 99, 0A, ..., 0Z, 1A, ...repeated.(G, I, J, O, Q, W excluded)

USP-3

① Represents product series

MARK	PRODUCT SERIES
0	IXD5120xxxxxx

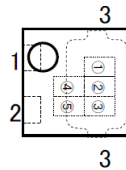

USP-3 (Top View)

② Represents output configuration and integer number of the detect voltage

MARK	DETECT VOLTAGE (V)	OUTPUT CONFIGURATION	MARK	DETECT VOLTAGE (V)	OUTPUT CONFIGURATION
A	1.x	CMOS Output	F	1.x	N-channel open drain
B	2.x		H	2.x	
C	3.x		K	3.x	
D	4.4		L	4.4	
E	5.x		M	5.x	

③ Represents decimal point of the detect voltage

MARK	DETECT VOLTAGE (V)	PRODUCT SERIES
3	x.3	IXD5120xx3xxx
0	x.0	IXD5120xx0xxx

④⑤ Represents production lot number

01 to 09, 10, 11, ..., 99, 0A, ..., 0Z, 1A, ...repeated.(G, I, J, O, Q, W excluded)

Customer Support

To share comments, get your technical questions answered, or report issues you may be experiencing with our products, please visit Zilog's Technical Support page at <http://support.zilog.com>. To learn more about this product, find additional documentation, or to discover other facets about Zilog product offerings, please visit the Zilog Knowledge Base at <http://zillog.com/kb> or consider participating in the Zilog Forum at <http://zillog.com/forum>. This publication is subject to replacement by a later edition. To determine whether a later edition exists, please visit the Zilog website at <http://www.zilog.com>.

Warning: DO NOT USE THIS PRODUCT IN LIFE SUPPORT SYSTEMS.

LIFE SUPPORT POLICY ZILOG'S PRODUCTS ARE NOT AUTHORIZED FOR USE AS CRITICAL COMPONENTS IN LIFE SUPPORT DEVICES OR SYSTEMS WITHOUT THE EXPRESS PRIOR WRITTEN APPROVAL OF THE PRESIDENT AND GENERAL COUNSEL OF ZILOG CORPORATION.

As used herein Life support devices or systems are devices which (a) are intended for surgical implant into the body, or (b) support or sustain life and whose failure to perform when properly used in accordance with instructions for use provided in the labeling can be reasonably expected to result in a significant injury to the user. A critical component is any component in a life support device or system whose failure to perform can be reasonably expected to cause the failure of the life support device or system or to affect its safety or effectiveness.

Document Disclaimer ©2015 Zilog, Inc. All rights reserved. Information in this publication concerning the devices, applications, or technology described is intended to suggest possible uses and may be superseded. ZILOG, INC. DOES NOT ASSUME LIABILITY FOR OR PROVIDE A REPRESENTATION OF ACCURACY OF THE INFORMATION, DEVICES, OR TECHNOLOGY DESCRIBED IN THIS DOCUMENT. ZILOG ALSO DOES NOT ASSUME LIABILITY FOR INTELLECTUAL PROPERTY INFRINGEMENT RELATED IN ANY MANNER TO USE OF INFORMATION, DEVICES, OR TECHNOLOGY DESCRIBED HEREIN OR OTHERWISE. The information contained within this document has been verified according to the general principles of electrical and mechanical engineering.