



Chipsmall Limited consists of a professional team with an average of over 10 year of expertise in the distribution of electronic components. Based in Hongkong, we have already established firm and mutual-benefit business relationships with customers from,Europe,America and south Asia,supplying obsolete and hard-to-find components to meet their specific needs.

With the principle of “Quality Parts,Customers Priority,Honest Operation,and Considerate Service”,our business mainly focus on the distribution of electronic components. Line cards we deal with include Microchip,ALPS,ROHM,Xilinx,Pulse,ON,Everlight and Freescale. Main products comprise IC,Modules,Potentiometer,IC Socket,Relay,Connector.Our parts cover such applications as commercial,industrial, and automotives areas.

We are looking forward to setting up business relationship with you and hope to provide you with the best service and solution. Let us make a better world for our industry!



Contact us

Tel: +86-755-8981 8866 Fax: +86-755-8427 6832

Email & Skype: info@chipsmall.com Web: www.chipsmall.com

Address: A1208, Overseas Decoration Building, #122 Zhenhua RD., Futian, Shenzhen, China



IXDD514 / IXDE514

14 Ampere Low-Side Ultrafast MOSFET Drivers with Enable for fast, controlled shutdown

Features

- Built using the advantages and compatibility of CMOS and IXYS HDMOS™ processes
- Latch-Up Protected over entire Operating Range
- High Peak Output Current: 14A Peak
- Wide Operating Range: 4.5V to 30V
- -55°C to +125°C Extended Operating Temperature
- Ability to Disable Output under Faults
- High Capacitive Load Drive Capability: 15nF in <30ns
- Matched Rise And Fall Times
- Low Propagation Delay Time
- Low Output Impedance
- Low Supply Current
- Two Drivers in Single Chip

Applications

- Driving MOSFETs and IGBTs
- Limiting di/dt under Short Circuit
- Motor Controls
- Line Drivers
- Pulse Generators
- Local Power ON/OFF Switch
- Switch Mode Power Supplies (SMPS)
- DC to DC Converters
- Pulse Transformer Driver
- Class D Switching Amplifiers
- Power Charge Pumps

General Description

The IXDD514 and IXDE514 are high speed high current gate drivers specifically designed to drive the largest IXYS MOSFETs & IGBTs to their minimum switching time and maximum practical frequency limits. The IXDD514 and IXDE514 can source and sink 14 Amps of Peak Current while producing voltage rise and fall times of less than 30ns. The inputs of the Drivers are compatible with TTL or CMOS and are virtually immune to latch up over the entire operating range! Patented* design innovations eliminate cross conduction and current "shoot-through". Improved speed and drive capabilities are further enhanced by very quick & matched rise and fall times.

The IXDD514 and IXDE514 incorporate a unique ability to disable the output under fault conditions. When a logical low is forced into the Enable input, both final output stage MOSFETs, (NMOS and PMOS) are turned off. As a result, the output of the IXDD514 or IXDE514 enters a tristate mode and achieves a Soft Turn-Off of the MOSFET/IGBT when a short circuit is detected. This helps prevent damage that could occur to the MOSFET/IGBT if it were to be switched off abruptly due to a dv/dt over-voltage transient.

The IXDD514 and IXDE514 are each available in the 8-Pin P-DIP (PI) package, the 8-Pin SOIC (SIA) package, and the 6-Lead DFN (D1) package, (which occupies less than 65% of the board area of the 8-Pin SOIC).

*United States Patent 6,917,227

Ordering Information

| Part Number | Description | Package Type | Packing Style | Pack Qty | Configuration |
|---------------|-------------------------------|--------------|---------------------|----------|---------------------------|
| IXDD514PI | 14A Low Side Gate Driver I.C. | 8-Pin PDIP | Tube | 50 | Non-Inverting with Enable |
| IXDD514SIA | 14A Low Side Gate Driver I.C. | 8-Pin SOIC | Tube | 94 | |
| IXDD514SIAT/R | 14A Low Side Gate Driver I.C. | 8-Pin SOIC | 13" Tape and Reel | 2500 | |
| IXDD514D1 | 14A Low Side Gate Driver I.C. | 6-Lead DFN | 2" x 2" Waffle Pack | 56 | |
| IXDD514D1T/R | 14A Low Side Gate Driver I.C. | 6-Lead DFN | 13" Tape and Reel | 2500 | |
| IXDE514PI | 14A Low Side Gate Driver I.C. | 8-Pin PDIP | Tube | 50 | Inverting with Enable |
| IXDE514SIA | 14A Low Side Gate Driver I.C. | 8-Pin SOIC | Tube | 94 | |
| IXDE514SIAT/R | 14A Low Side Gate Driver I.C. | 8-Pin SOIC | 13" Tape and Reel | 2500 | |
| IXDE514D1 | 14A Low Side Gate Driver I.C. | 6-Lead DFN | 2" x 2" Waffle Pack | 56 | |
| IXDE514D1T/R | 14A Low Side Gate Driver I.C. | 6-Lead DFN | 13" Tape and Reel | 2500 | |

NOTE: All parts are lead-free and RoHS Compliant

Figure 1 - IXDD514 14A Non-Inverting Gate Driver Functional Block Diagram

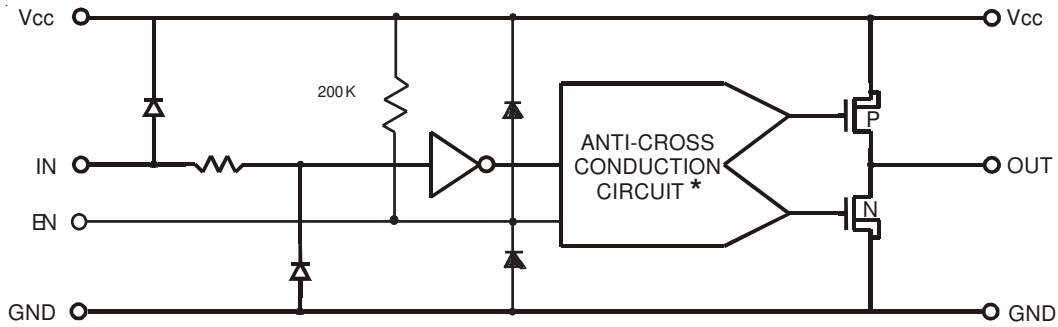
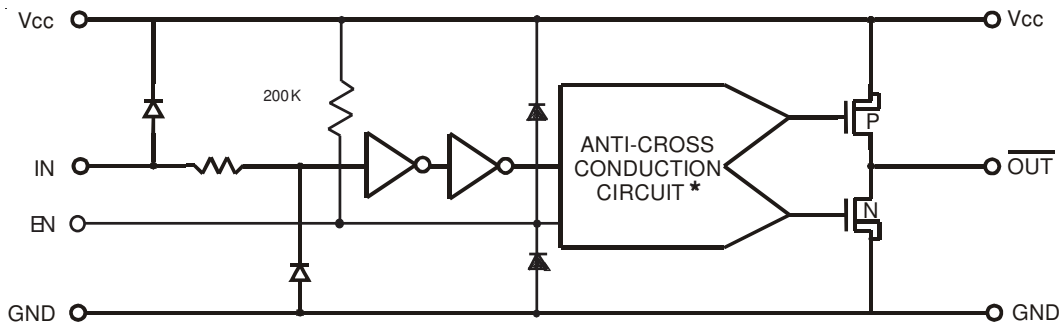
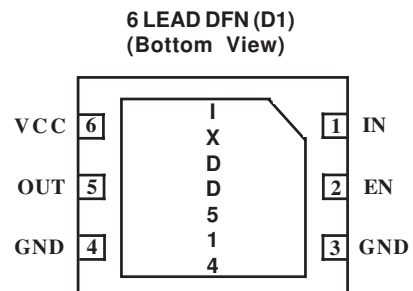
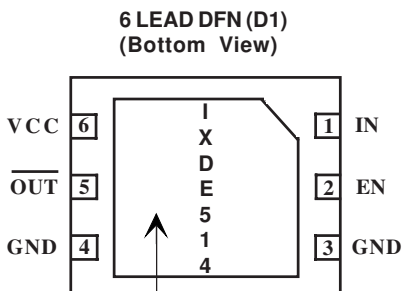
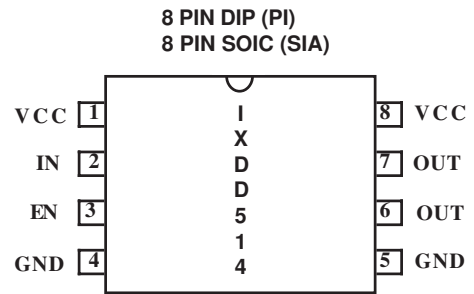
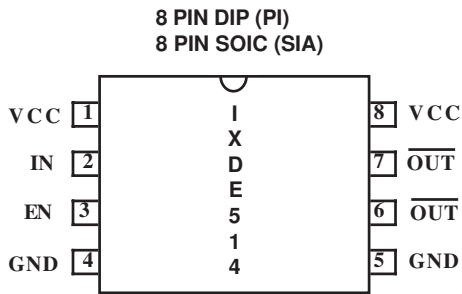

Figure 2 - IXDE514 Inverting 14A Gate Driver Functional Block Diagram



* United States Patent 6,917,227

PIN CONFIGURATIONS



NOTE: Solder tabs on bottoms of DFN packages are grounded

Absolute Maximum Ratings ⁽¹⁾

| Parameter | Value |
|---|---------------------------|
| Supply Voltage | 35 V |
| All Other Pins (unless specified otherwise) | -0.3 V to $V_{CC} + 0.3V$ |
| Junction Temperature | 150 °C |
| Storage Temperature | -65 °C to 150 °C |
| Lead Temperature (10 Sec) | 300 °C |

Operating Ratings ⁽²⁾

| Parameter | Value |
|-----------------------------|-----------------------------------|
| Operating Supply Voltage | 4.5V to 30V |
| Operating Temperature Range | -55 °C to 125 °C |
| Package Thermal Resistance* | |
| 8-PinPDIP (PI) | θ_{J-A} (typ) 125 °C/W |
| 8-PinSOIC (SIA) | θ_{J-A} (typ) 200 °C/W |
| 6-LeadDFN (D1) | θ_{J-A} (typ) 125-200 °C/W |
| 6-LeadDFN (D1) | θ_{J-C} (max) 1.5 °C/W |
| 6-LeadDFN (D1) | θ_{J-S} (typ) 5.8 °C/W |

Electrical Characteristics @ $T_A = 25\text{ °C}$ ⁽³⁾

Unless otherwise noted, $4.5V \leq V_{CC} \leq 30V$.

All voltage measurements with respect to GND. IXD_514 configured as described in *Test Conditions*.

| Symbol | Parameter | Test Conditions | Min | Typ ⁽⁴⁾ | Max | Units |
|-------------------|--|--------------------------------------|------------------|--------------------|----------------|-----------|
| V_{IH}, V_{ENH} | High input & EN voltage | $4.5V \leq V_{CC} \leq 18V$ | 2.5 | | | V |
| V_{IL}, V_{ENL} | Low input & EN voltage | $4.5V \leq V_{CC} \leq 18V$ | | | 1.0 | V |
| V_{IN} | Input voltage range | | -5 | | $V_{CC} + 0.3$ | V |
| V_{EN} | Enable voltage range | | -3 | | $V_{CC} + 0.3$ | V |
| I_{IN} | Input current | $0V \leq V_{IN} \leq V_{CC}$ | -10 | | 10 | μA |
| V_{OH} | High output voltage | | $V_{CC} - 0.025$ | | | V |
| V_{OL} | Low output voltage | | | | 0.025 | V |
| R_{OH} | Output resistance @ Output high | $I_{OUT} = 10mA, V_{CC} = 18V$ | | 600 | 1000 | $m\Omega$ |
| R_{OL} | Output resistance @ Output Low | $I_{OUT} = 10mA, V_{CC} = 18V$ | | 600 | 1000 | $m\Omega$ |
| I_{PEAK} | Peak output current | V_{CC} is 18V | | 14 | | A |
| I_{DC} | Continuous output current | Limited by package power dissipation | | | 4 | A |
| t_R | Rise time | $C_L = 15nF, V_{CC} = 18V$ | 23 | 25 | 40 | ns |
| t_F | Fall time | $C_L = 15nF, V_{CC} = 18V$ | 21 | 22 | 50 | ns |
| t_{ONDLY} | On-time propagation delay | $C_L = 15nF, V_{CC} = 18V$ | 29 | 30 | 30 | ns |
| t_{OFFDLY} | Off-time propagation delay | $C_L = 15nF, V_{CC} = 18V$ | 29 | 31 | 50 | ns |
| t_{ENOH} | Enable to output high delay time | $V_{CC} = 18V$ | | | 40 | ns |
| t_{DOLD} | Disable to output low Disable delay time | $V_{CC} = 18V$ | | | 30 | ns |
| V_{CC} | Power supply voltage | | 4.5 | 18 | 30 | V |
| I_{CC} | Power supply current | $V_{IN} = 3.5V$ | | 1 | 3 | mA |
| | | $V_{IN} = 0V$ | | 0 | 10 | μA |
| | | $V_{IN} = + V_{CC}$ | | | 10 | μA |

Electrical Characteristics @ temperatures over -55 °C to 125 °C ⁽³⁾

Unless otherwise noted, $4.5V \leq V_{CC} \leq 30V$, $T_j < 150^\circ C$

All voltage measurements with respect to GND. IXD_502 configured as described in *Test Conditions*. All specifications are for one channel.

| Symbol | Parameter | Test Conditions | Min | Typ ⁽⁴⁾ | Max | Units |
|--------------|------------------------------------|--------------------------------|------------------|--------------------|----------------|----------|
| V_{IH} | High input voltage | $4.5V \leq V_{CC} \leq 18V$ | 2.7 | | | V |
| V_{IL} | Low input voltage | $4.5V \leq V_{CC} \leq 18V$ | | | 0.8 | V |
| V_{IN} | Input voltage range | | -5 | | $V_{CC} + 0.3$ | V |
| I_{IN} | Input current | $0V \leq V_{IN} \leq V_{CC}$ | -10 | | 10 | μA |
| V_{OH} | High output voltage | | $V_{CC} - 0.025$ | | | V |
| V_{OL} | Low output voltage | | | | 0.025 | V |
| R_{OH} | Output resistance @ Output high | $V_{CC} = 18V$ | | | 1.25 | Ω |
| R_{OL} | Output resistance @ Output Low | $V_{CC} = 18V$ | | | 1.25 | Ω |
| I_{DC} | Continuous output current | | | | 1 | A |
| t_R | Rise time | $C_L=15\text{ nF } V_{CC}=18V$ | | 23 | 100 | ns |
| t_F | Fall time | $C_L=15\text{ nF } V_{CC}=18V$ | | 30 | 100 | ns |
| t_{ONDLY} | On-time propagation delay | $C_L=15\text{ nF } V_{CC}=18V$ | | 20 | 60 | ns |
| t_{OFFDLY} | Off-time propagation delay | $C_L=15\text{ nF } V_{CC}=18V$ | | 40 | 60 | ns |
| V_{CC} | Power supply voltage | | 4.5 | 18 | 30 | V |
| I_{CC} | Power supply current | $V_{IN} = 3.5V$ | | 1 | 3 | mA |
| | | $V_{IN} = 0V$ | | 0 | 10 | μA |
| | | $V_{IN} = + V_{CC}$ | | | 10 | μA |

Notes:

1. Operating the device beyond the parameters listed as "Absolute Maximum Ratings" may cause permanent damage to the device. Exposure to absolute maximum rated conditions for extended periods may affect device reliability.
2. The device is not intended to be operated outside of the Operating Ratings.
3. Electrical Characteristics provided are associated with the stated Test Conditions.
4. Typical values are presented in order to communicate how the device is expected to perform, but not necessarily to highlight any specific performance limits within which the device is guaranteed to function.

* The following notes are meant to define the conditions for the θ_{J-A} , θ_{J-C} and θ_{J-S} values:

- 1) The θ_{J-A} (typ) is defined as junction to ambient. The θ_{J-A} of the standard single die 8-Lead PDIP and 8-Lead SOIC are dominated by the resistance of the package, and the IXD_5XX are typical. The values for these packages are natural convection values with vertical boards and the values would be lower with natural convection. For the 6-Lead DFN package, the θ_{J-A} value supposes the DFN package is soldered on a PCB. The θ_{J-A} (typ) is 200 °C/W with no special provisions on the PCB, but because the center pad provides a low thermal resistance to the die, it is easy to reduce the θ_{J-A} by adding connected copper pads or traces on the PCB. These can reduce the θ_{J-A} (typ) to 125 °C/W easily, and potentially even lower. The θ_{J-A} for DFN on PCB without heatsink or thermal management will vary significantly with size, construction, layout, materials, etc. This typical range tells the user what he is likely to get if he does no thermal management.
- 2) θ_{J-C} (max) is defined as junction to case, where case is the large pad on the back of the DFN package. The θ_{J-C} values are generally not published for the PDIP and SOIC packages. The θ_{J-C} for the DFN packages are important to show the low thermal resistance from junction to the die attach pad on the back of the DFN, -- and a guardband has been added to be safe.
- 3) The θ_{J-S} (typ) is defined as junction to heatsink, where the DFN package is soldered to a thermal substrate that is mounted on a heatsink. The value must be typical because there are a variety of thermal substrates. This value was calculated based on easily available IMS in the U.S. or Europe, and not a premium Japanese IMS. A 4 mil dielectric with a thermal conductivity of 2.2W/mC was assumed. The result was given as typical, and indicates what a user would expect on a typical IMS substrate, and shows the potential low thermal resistance for the DFN package.

Pin Description

| SYMBOL | FUNCTION | DESCRIPTION |
|--------|----------------|--|
| VCC | Supply Voltage | Positive power-supply voltage input. This pin provides power to the entire chip. The range for this voltage is from 4.5V to 30V. |
| IN | Input | Input signal-TTL or CMOS compatible. |
| EN | Enable | The system Enable pin. This pin, when driven low, disables the chip, forcing a high impedance state to the output. EN pulled high by a resistor. |
| OUT | Output | Driver Output. For application purposes, this pin is connected, through a resistor, to Gate of a MOSFET/IGBT. |
| GND | Ground | The system ground pin. Internally connected to all circuitry, this pin provides ground reference for the entire chip. This pin should be connected to a low noise analog ground plane for optimum performance. |

CAUTION: Follow proper ESD procedures when handling and assembling this component.

Figure 3 - Characteristics Test Diagram

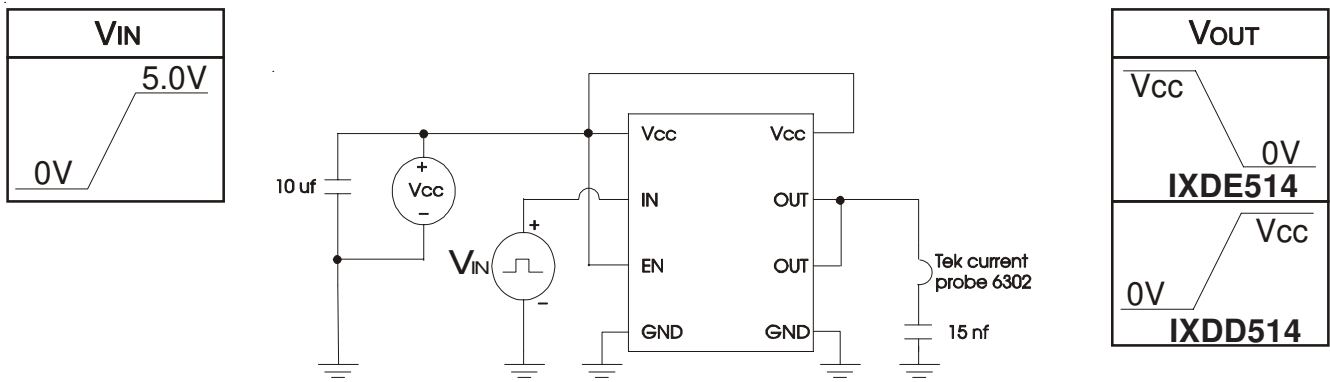
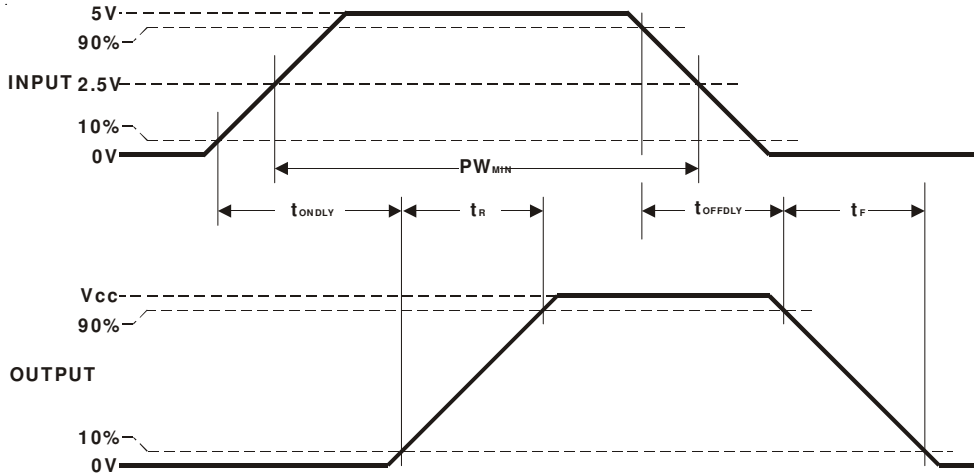
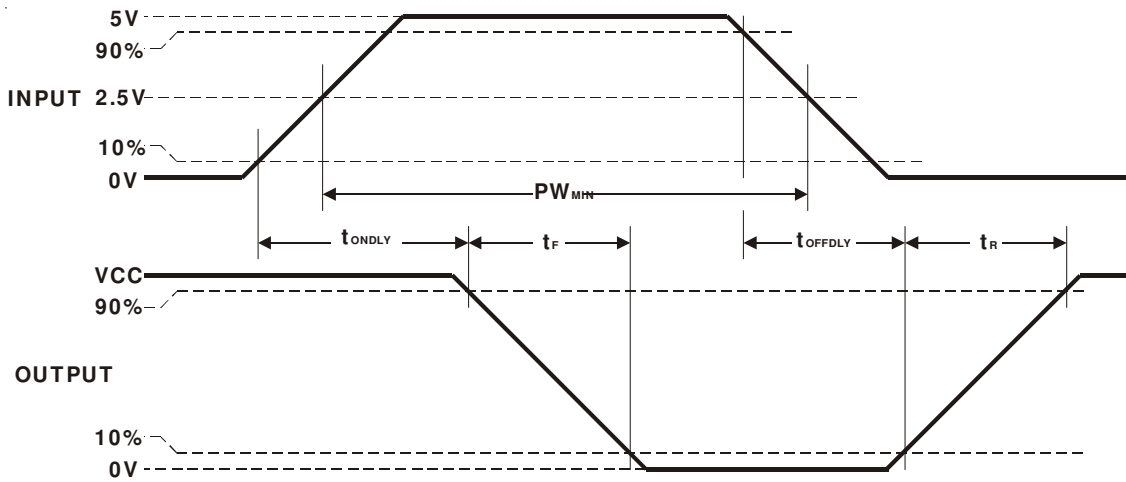

Figure 4 - Timing Diagrams

Non-Inverting (IXDD514) Timing Diagram



Inverting (IXDE514) Timing Diagram



IXYS reserves the right to change limits, test conditions, and dimensions.

Typical Performance Characteristics

Fig. 5 Rise Time vs. Supply Voltage

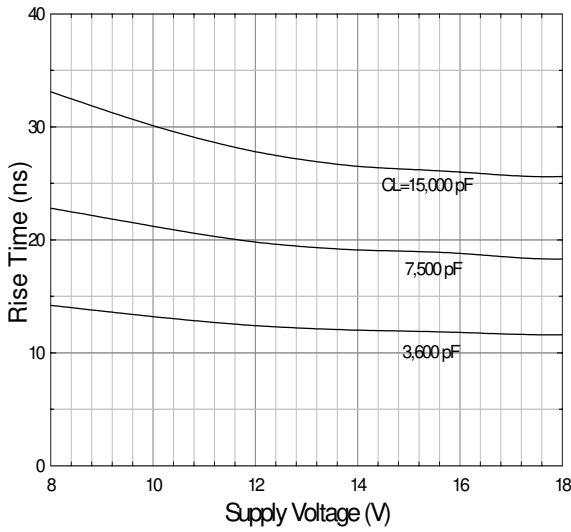

Fig. 6 Fall Time vs. Supply Voltage

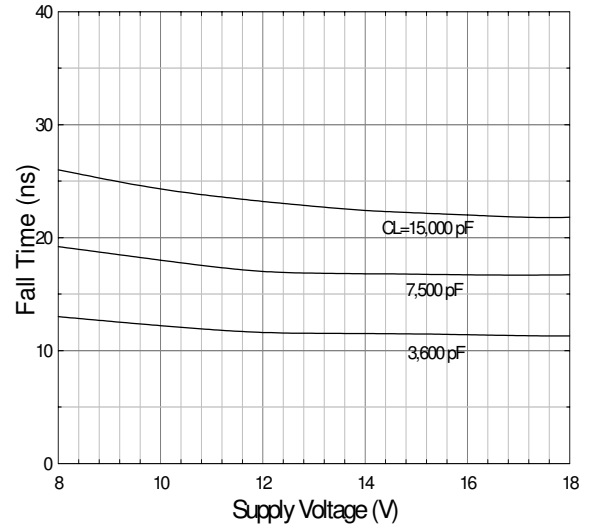

Fig. 7 Rise And Fall Times vs. Case Temperature
 $C_L = 15 \text{ nF}$, $V_{CC} = 18\text{V}$

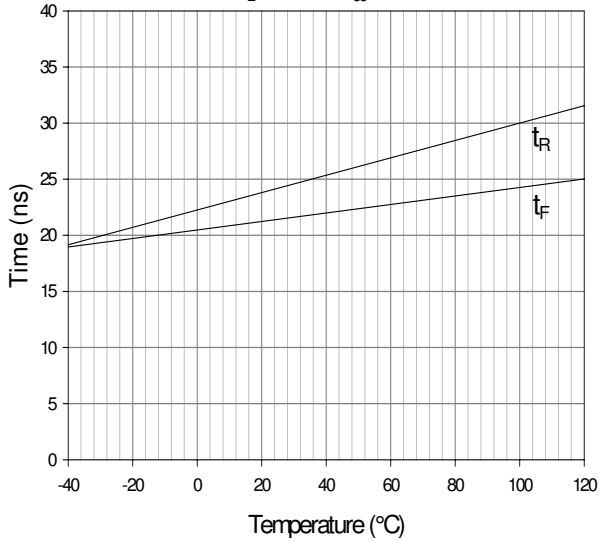

Fig. 8 Rise Time vs. Load Capacitance

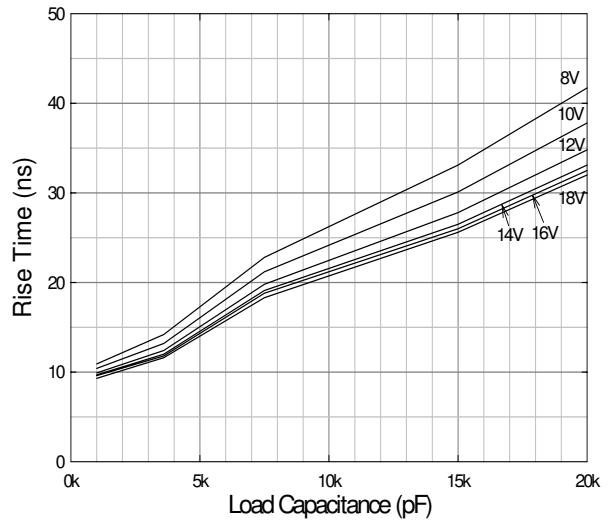

Fig. 9 Fall Time vs. Load Capacitance

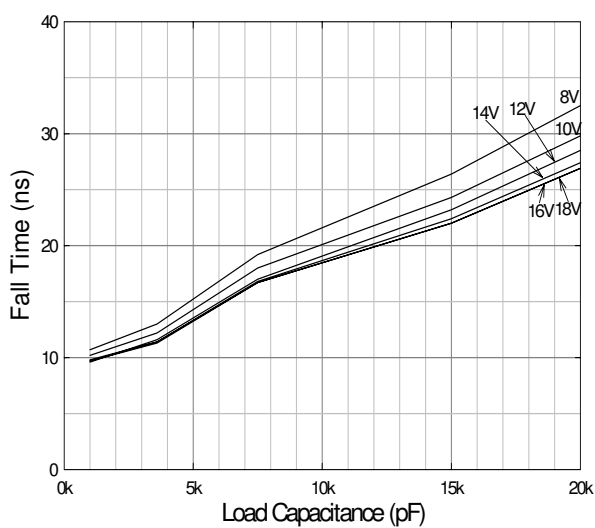

Fig. 10 Max / Min Input vs. Case Temperature
 $V_{CC} = 18\text{V}$, $C_L = 15\text{nF}$

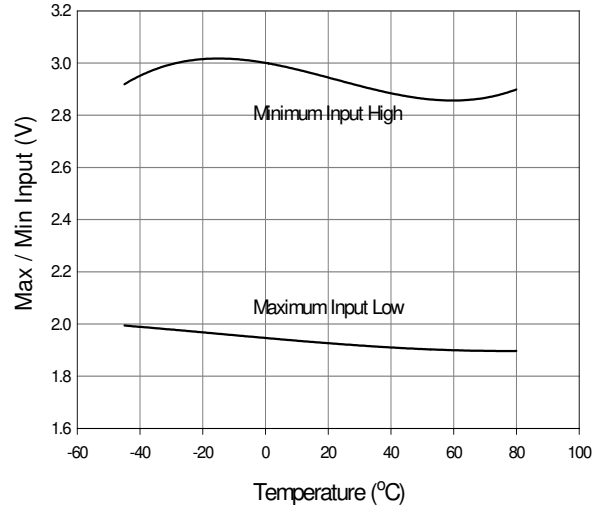

Fig. 11 Supply Current vs. Load Capacitance
V_{CC}=18V

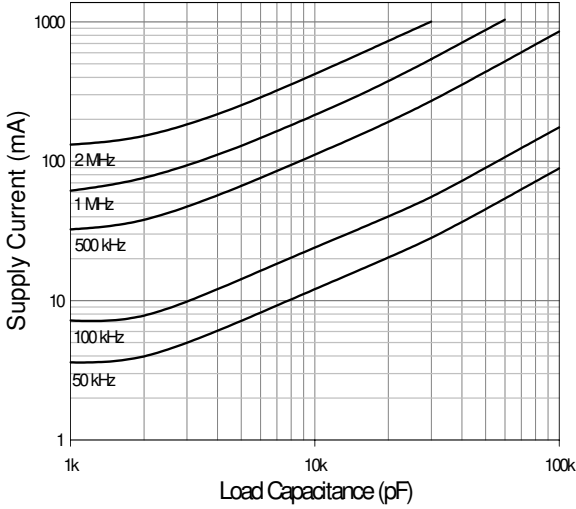

Fig. 12 Supply Current vs. Frequency
V_{CC}=18V

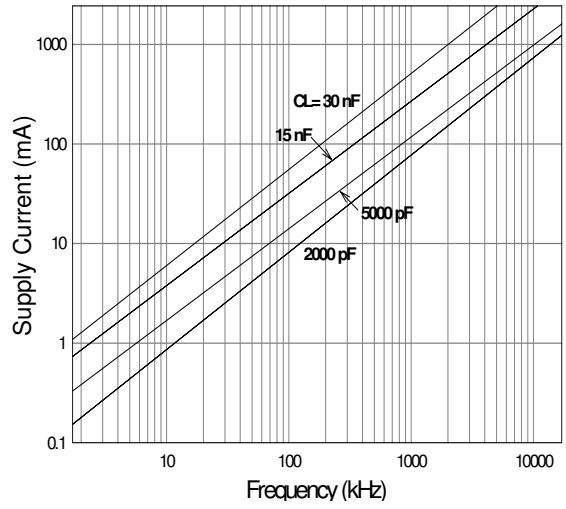

Fig. 13 Supply Current vs. Load Capacitance
V_{CC}=12V

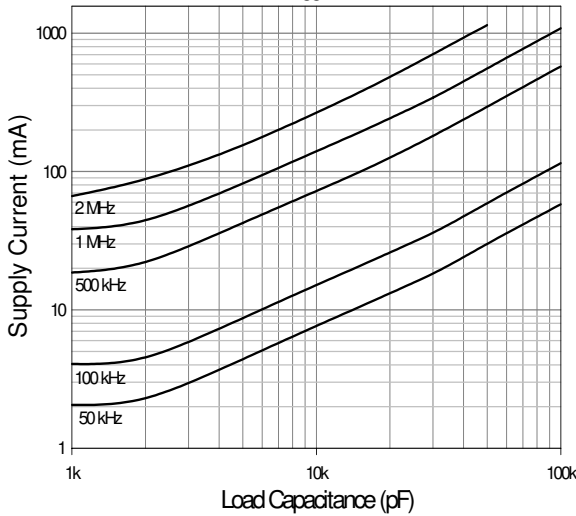

Fig. 14 Supply Current vs. Frequency
V_{CC}=12V

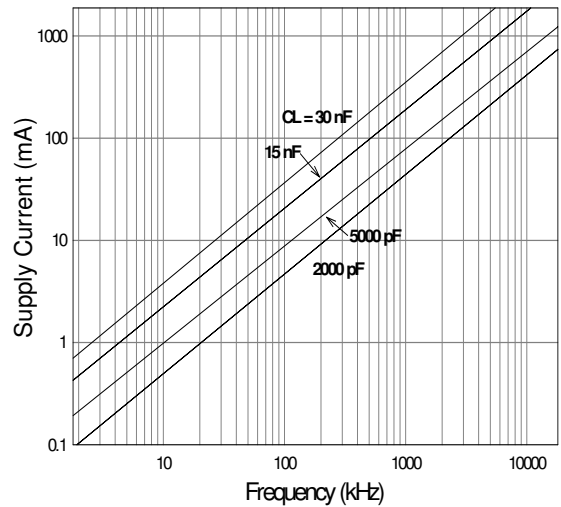

Fig. 15 Supply Current vs. Load Capacitance
V_{CC}=8V

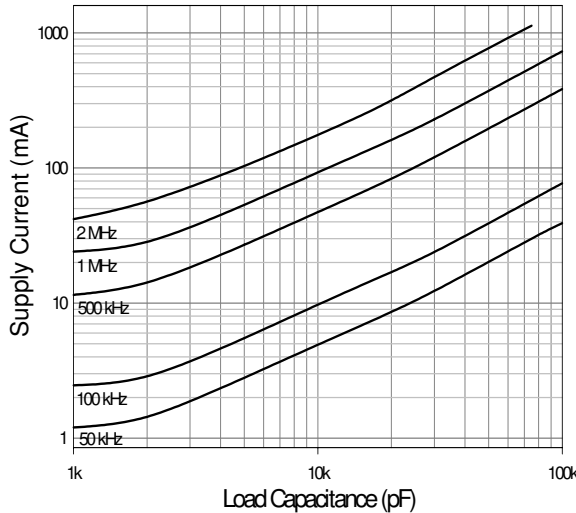

Fig. 16 Supply Current vs. Frequency
V_{CC}=8V

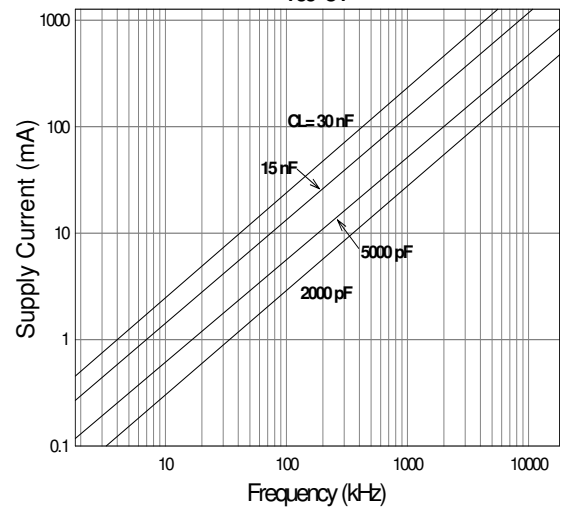

Fig. 17 Propagation Delay vs. Supply Voltage
 $C_L = 15\text{nF}$ $V_{IN} = 5\text{V}@1\text{kHz}$

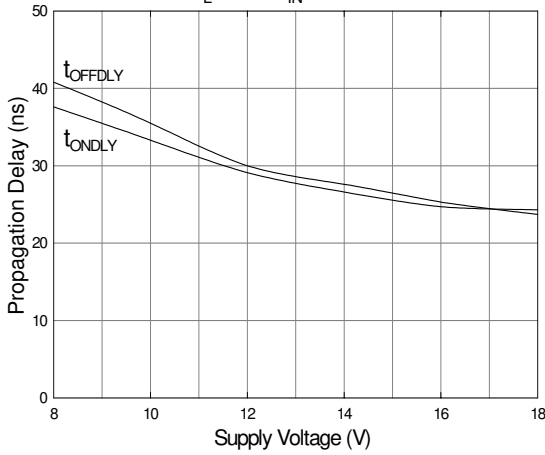

Fig. 18 Propagation Delay vs. Input Voltage
 $C_L = 15\text{nF}$ $V_{CC} = 15\text{V}$

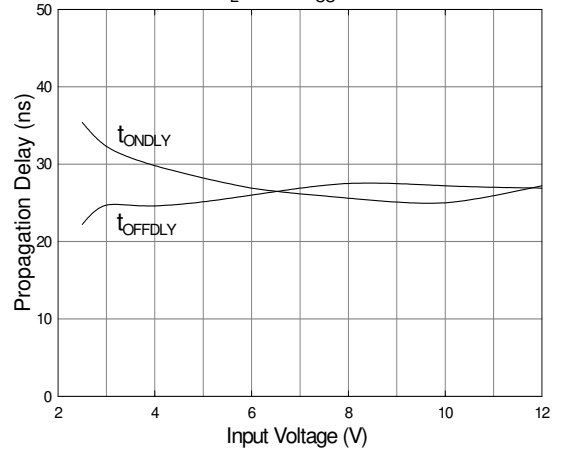

Fig. 19 Propagation Delay vs. Case Temperature
 $C_L = 2500\text{pF}$, $V_{CC} = 18\text{V}$

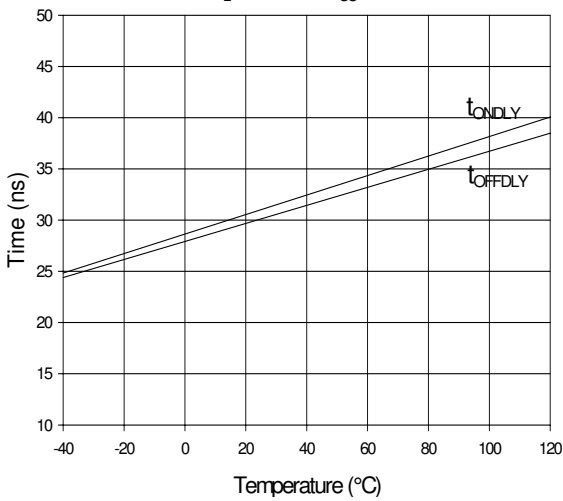

Fig. 20 Quiescent Supply Current vs. Case Temperature
 $V_{CC} = 18\text{V}$ $V_{IN} = 5\text{V}@1\text{kHz}$

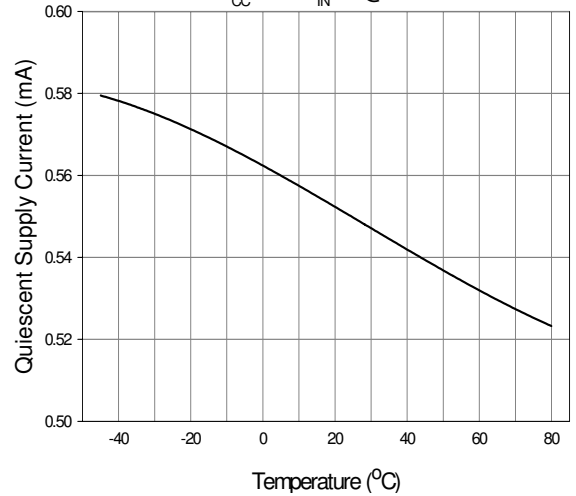

Fig. 21 P Channel Output Current vs. Case Temperature
 $V_{CC} = 18\text{V}$ $C_L = 1\mu\text{F}$

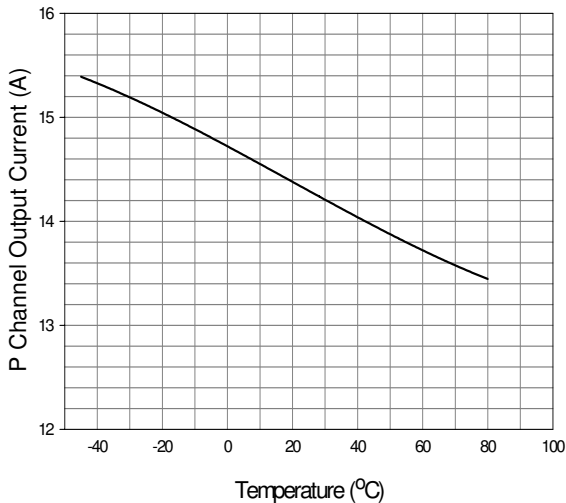

Fig. 22 N Channel Output Current vs. Case Temperature
 $V_{CC} = 18\text{V}$ $C_L = 1\mu\text{F}$

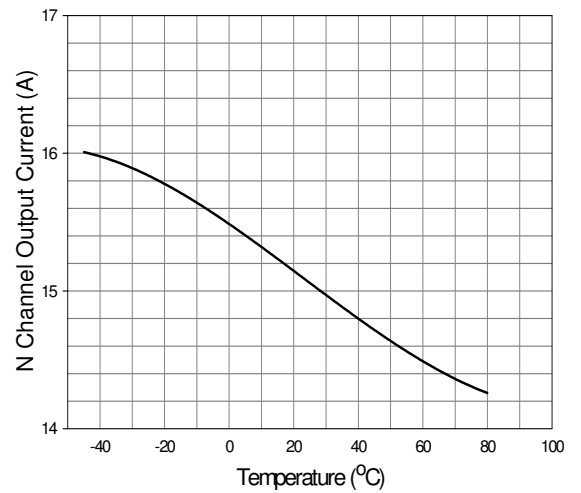

Fig. 23 Enable Threshold vs. Supply Voltage

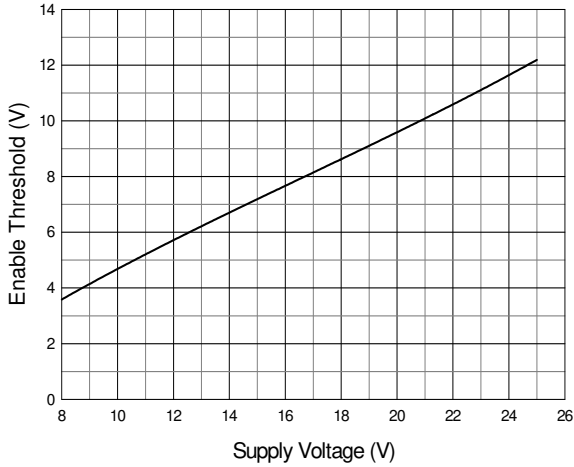

Fig. 24 High State Output Resistance vs. Supply Voltage

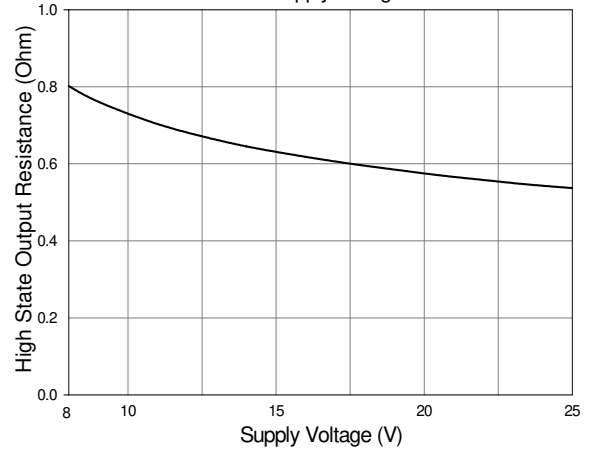

Fig. 25 Low-State Output Resistance vs. Supply Voltage

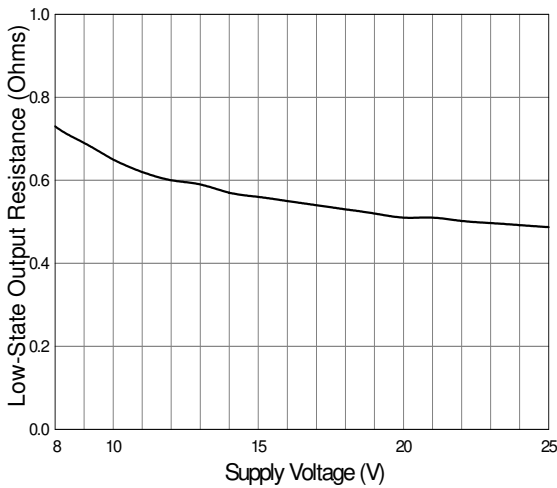

Fig. 26 V_{OC} vs. P Channel Output Current
 $C_L = 1\mu F$ $V_{IN} = 0-5V @ 1kHz$

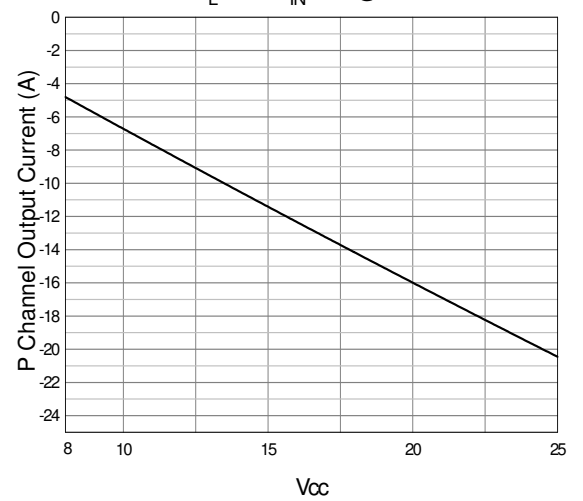

Fig. 27 V_{CC} vs. N Channel Output Current
 $C_L = 1\mu F$ $V_{IN} = 0-5V @ 1kHz$

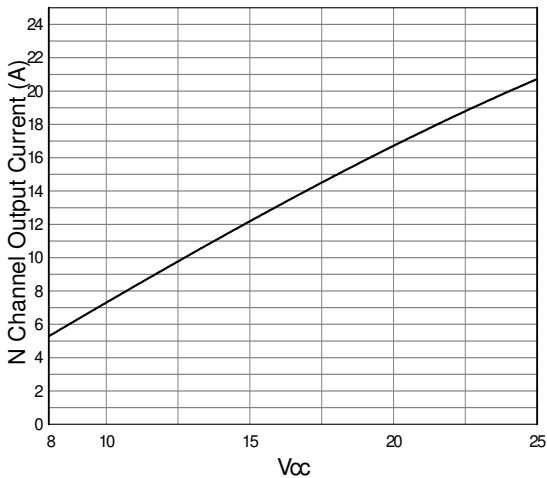
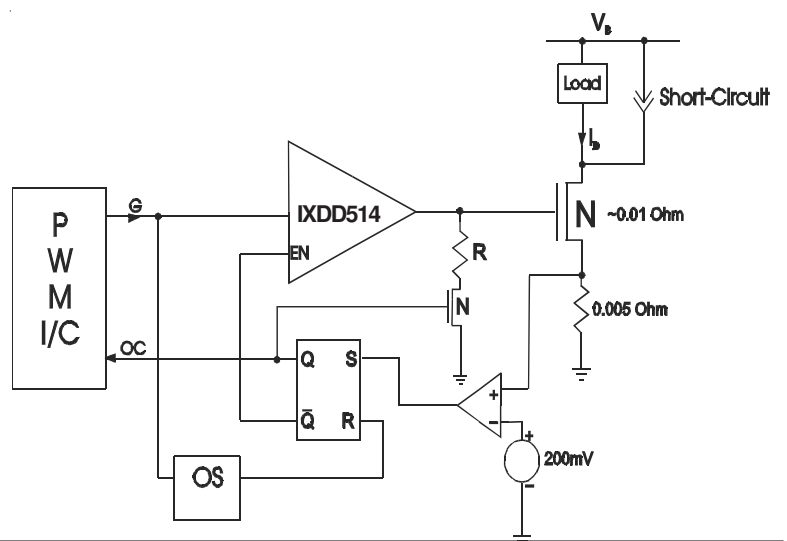

Figure 28 - Typical Application Short Circuit di/dt Limit



Short Circuit di/dt Limit

A short circuit in a high-power MOSFET module such as the VM0580-02F, (580A, 200V), as shown in Figure 28, can cause the current through the module to flow in excess of 1500A for 10 μ s or more prior to self-destruction due to thermal runaway. For this reason, some protection circuitry is needed to turn off the MOSFET module. However, if the module is switched off too fast, there is a danger of voltage transients occurring on the drain due to Ldi/dt, (where L represents total inductance in series with drain). If these voltage transients exceed the MOSFET's voltage rating, this can cause an avalanche breakdown.

The IXDD514 and IXDE514 have the unique capability to softly switch off the high-power MOSFET module, significantly reducing these Ldi/dt transients.

Thus, the IXDD514/IXDE514 help to prevent device destruction from *both* dangers; over-current, and avalanche breakdown due to di/dt induced over-voltage transients.

The IXDD514/IXDE514 are designed to not only provide $\pm 14A$ under normal conditions, but also to allow their outputs to go into a high impedance state. This permits the IXDD514/IXDE514 output to control a separate weak pull-down circuit during detected overcurrent shutdown conditions to limit and separately control d_{VGS}/dt gate turnoff. This circuit is shown in Figure 29.

Referring to Figure 29, the protection circuitry should include a comparator, whose positive input is connected to the source of the VM0580-02. A low pass filter should be added to the input of the comparator to eliminate any glitches in voltage caused

APPLICATIONS INFORMATION

by the inductance of the wire connecting the source resistor to ground. (Those glitches might cause false triggering of the comparator).

The comparator's output should be connected to a SRFF (Set Reset Flip Flop). The flip-flop controls both the Enable signal, and the low power MOSFET gate. Please note that CMOS 4000-series devices operate with a V_{CC} range from 3 to 15 VDC, (with 18 VDC being the maximum allowable limit).

A low power MOSFET, such as the 2N7000, in series with a resistor, will enable the VM0580-02F gate voltage to drop gradually. The resistor should be chosen so that the RC time constant will be 100 μ s, where "C" is the Miller capacitance of the VM0580-02F.

For resuming normal operation, a Reset signal is needed at the SRFF's input to enable the IXDD514/IXDE514 again. This Reset can be generated by connecting a One Shot circuit between the IXDD514/IXDE514 Input signal and the SRFF restart input. The One Shot will create a pulse on the rise of the IXDD514/IXDE514 input, and this pulse will reset the SRFF outputs to normal operation.

When a short circuit occurs, the voltage drop across the low-value, current-sensing resistor, ($R_s=0.005$ Ohm), connected between the MOSFET Source and ground, increases. This triggers the comparator at a preset level. The SRFF drives a low input into the Enable pin disabling the IXDD514/IXDE514 output. The SRFF also turns on the low power MOSFET, (2N7000).

In this way, the high-power MOSFET module is softly turned off by the IXDD514/IXDE514, preventing its destruction.

Figure 29 - Application Test Diagram

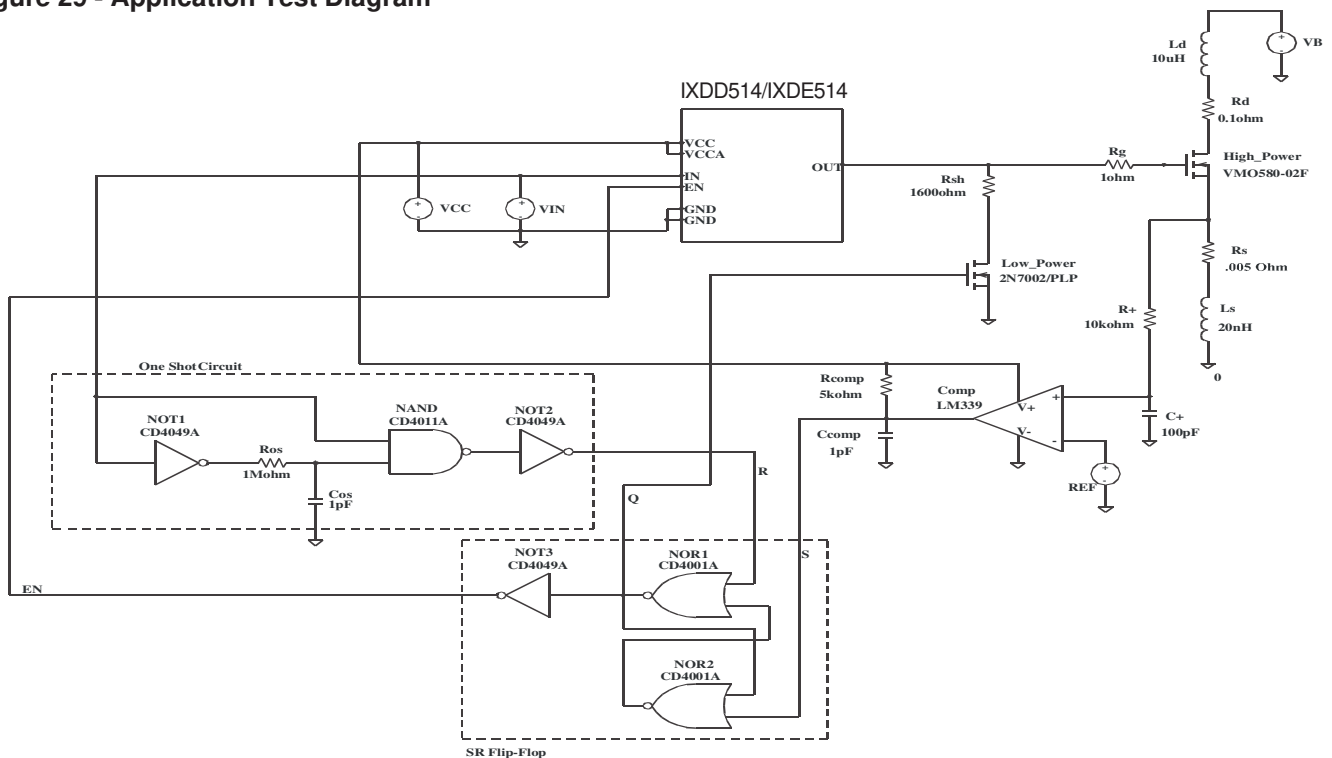

Supply Bypassing and Grounding Practices, Output Lead inductance

When designing a circuit to drive a high speed MOSFET utilizing the IXDD514/IXDE514, it is very important to keep certain design criteria in mind, in order to optimize performance of the driver. Particular attention needs to be paid to **Supply Bypassing, Grounding,** and minimizing the **Output Lead Inductance.**

Say, for example, we are using the IXDD514 to charge a 5000pF capacitive load from 0 to 25 volts in 25ns...

Using the formula: $I = \Delta V C / \Delta t$, where $\Delta V = 25V$ $C = 5000pF$ & $\Delta t = 25ns$ we can determine that to charge 5000pF to 25 volts in 25ns will take a constant current of 5A. (In reality, the charging current won't be constant, and will peak somewhere around 8A).

SUPPLY BYPASSING

In order for our design to turn the load on properly, the IXDD514 must be able to draw this 5A of current from the power supply in the 25ns. This means that there must be very low impedance between the driver and the power supply. The most common method of achieving this low impedance is to bypass the power supply at the driver with a capacitance value that is a magnitude larger than the load capacitance. Usually, this would be achieved by placing two different types of bypassing capacitors, with complementary impedance curves, very close to the driver itself. (These capacitors should be carefully selected, low inductance, low resistance, high-pulse current-service capacitors). Lead lengths may radiate at high frequency due to inductance, so care should be taken to keep the lengths of the leads between these bypass capacitors and the IXDD514 to an absolute minimum.

GROUNDING

In order for the design to turn the load off properly, the IXDD514 must be able to drain this 5A of current into an adequate grounding system. There are three paths for returning current that need to be considered: Path #1 is between the IXDD514 and it's load. Path #2 is between the IXDD514 and it's power supply. Path #3 is between the IXDD514 and whatever logic is driving it. All three of these paths should be as low in resistance and inductance as possible, and thus as short as practical. In addition, every effort should be made to keep these three ground paths distinctly separate. Otherwise, (for instance), the returning ground current from the load may develop a voltage that would have a detrimental effect on the logic line driving the IXDD514.

OUTPUT LEAD INDUCTANCE

Of equal importance to Supply Bypassing and Grounding are issues related to the Output Lead Inductance. Every effort should be made to keep the leads between the driver and it's load as short and wide as possible. If the driver must be placed farther than 2" from the load, then the output leads should be treated as transmission lines. In this case, a twisted-pair should be considered, and the return line of each twisted pair should be placed as close as possible to the ground pin of the driver, and connect directly to the ground terminal of the load.

PRELIMINARY TECHNICAL INFORMATION

The product presented herein is under development. The Technical Specifications offered are derived from data gathered during objective characterizations of preliminary engineering lots; but also may yet contain some information supplied during a pre-production design evaluation. IXYS reserves the right to change limits, test conditions, and dimensions without notice.

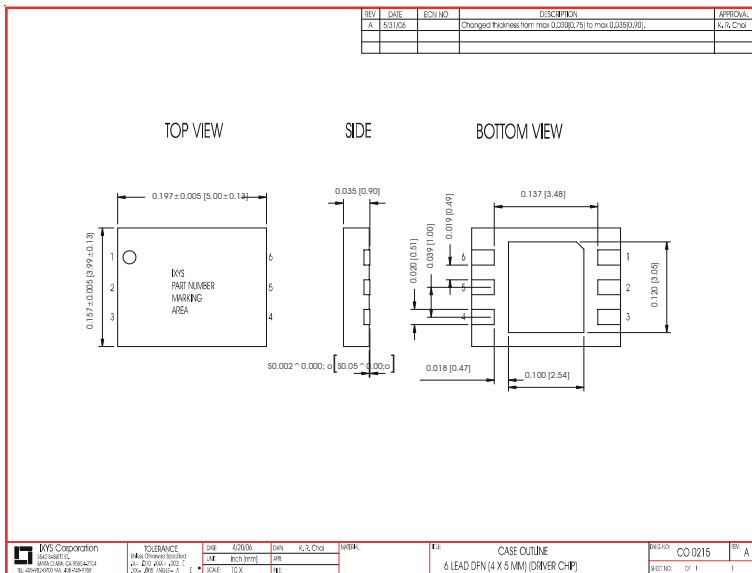
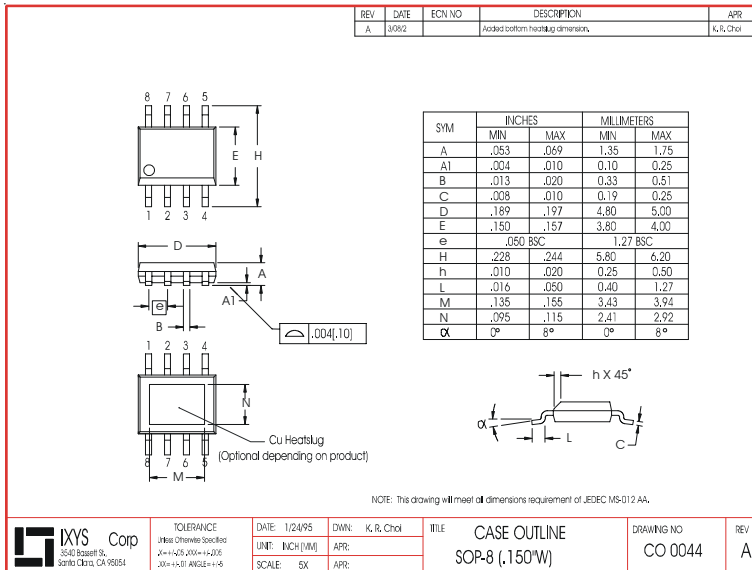
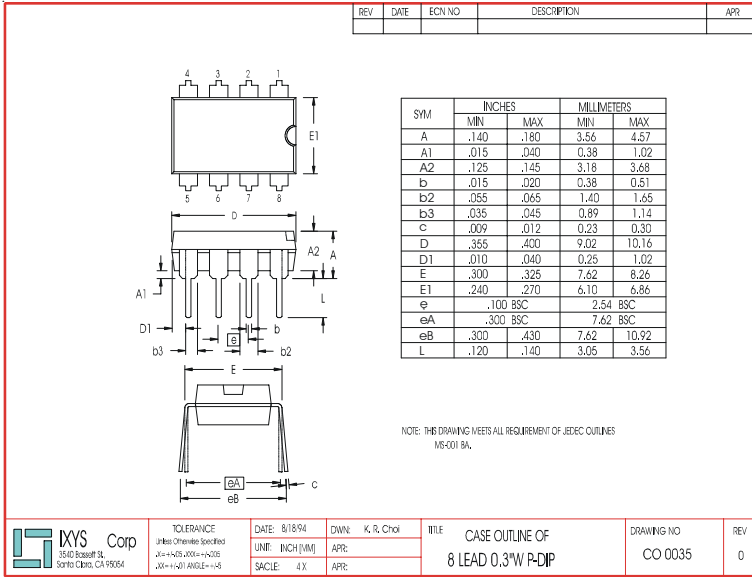

IXYS Corporation
3540 Bassett St; Santa Clara, CA 95054
Tel: 408-982-0700; Fax: 408-496-0670
e-mail: sales@ixys.net
www.ixys.com

IXYS Semiconductor GmbH
Edisonstrasse 15 ; D-68623; Lampertheim
Tel: +49-6206-503-0; Fax: +49-6206-503627
e-mail: marcom@ixys.de