



Chipsmall Limited consists of a professional team with an average of over 10 year of expertise in the distribution of electronic components. Based in Hongkong, we have already established firm and mutual-benefit business relationships with customers from,Europe,America and south Asia,supplying obsolete and hard-to-find components to meet their specific needs.

With the principle of “Quality Parts,Customers Priority,Honest Operation,and Considerate Service”,our business mainly focus on the distribution of electronic components. Line cards we deal with include Microchip,ALPS,ROHM,Xilinx,Pulse,ON,Everlight and Freescale. Main products comprise IC,Modules,Potentiometer,IC Socket,Relay,Connector.Our parts cover such applications as commercial,industrial, and automotives areas.

We are looking forward to setting up business relationship with you and hope to provide you with the best service and solution. Let us make a better world for our industry!



Contact us

Tel: +86-755-8981 8866 Fax: +86-755-8427 6832

Email & Skype: info@chipsmall.com Web: www.chipsmall.com

Address: A1208, Overseas Decoration Building, #122 Zhenhua RD., Futian, Shenzhen, China



IXDI514 / IXDN514

14 Ampere Low-Side Ultrafast MOSFET Drivers

Features

- Built using the advantages and compatibility of CMOS and IXYS HDMOS™ processes
- Latch-Up Protected over entire Operating Range
- High Peak Output Current: 14A Peak
- Wide Operating Range: 4.5V to 30V
- -55°C to +125°C Extended Operating Temperature
- High Capacitive Load Drive Capability: 15nF in <30ns
- Matched Rise And Fall Times
- Low Propagation Delay Time
- Low Output Impedance
- Low Supply Current
- Two Drivers in Single Chip

Applications

- Driving MOSFETs and IGBTs
- Motor Controls
- Line Drivers
- Pulse Generators
- Local Power ON/OFF Switch
- Switch Mode Power Supplies (SMPS)
- DC to DC Converters
- Pulse Transformer Driver
- Class D Switching Amplifiers
- Power Charge Pumps

General Description

The IXDI514 and IXDN514 are high speed high current gate drivers specifically designed to drive the largest IXYS MOSFETs & IGBTs to their minimum switching time and maximum practical frequency limits. The IXDI514 and IXDN514 can source and sink 14 Amps of Peak Current while producing voltage rise and fall times of less than 30ns. The inputs of the Drivers are compatible with TTL or CMOS and are virtually immune to latch up over the entire operating range! Patented* design innovations eliminate cross conduction and current "shoot-through". Improved speed and drive capabilities are further enhanced by very quick & matched rise and fall times.

The IXDI514 is configured as a Inverting Gate Driver, and the IXDN514 is configured as a Non-Inverting Gate Driver.

The IXDI514 and IXDN514 are each available in the 8-Pin P-DIP (PI) package, the 8-Pin SOIC (SIA) package, and the 6-Lead DFN (D1) package, (which occupies less than 65% of the board area of the 8-Pin SOIC).

*United States Patent 6,917,227

Ordering Information

Part Number	Description	Package Type	Packing Style	Pack Qty	Configuration
IXDI514PI	14A Low Side Gate Driver I.C.	8-Pin PDIP	Tube	50	Inverting
IXDI514SIA	14A Low Side Gate Driver I.C.	8-Pin SOIC	Tube	94	
IXDI514SIAT/R	14A Low Side Gate Driver I.C.	8-Pin SOIC	13" Tape and Reel	2500	
IXDI514D1	14A Low Side Gate Driver I.C.	6-Lead DFN	2" x 2" Waffle Pack	56	
IXDI514D1T/R	14A Low Side Gate Driver I.C.	6-Lead DFN	13" Tape and Reel	2500	
IXDN514PI	14A Low Side Gate Driver I.C.	8-Pin PDIP	Tube	50	Non-Inverting
IXDN514SIA	14A Low Side Gate Driver I.C.	8-Pin SOIC	Tube	94	
IXDN514SIAT/R	14A Low Side Gate Driver I.C.	8-Pin SOIC	13" Tape and Reel	2500	
IXDN514D1	14A Low Side Gate Driver I.C.	6-Lead DFN	2" x 2" Waffle Pack	56	
IXDN514D1T/R	14A Low Side Gate Driver I.C.	6-Lead DFN	13" Tape and Reel	2500	

NOTE: All parts are lead-free and RoHS Compliant

Figure 1 - IXDI514 Inverting 14A Gate Driver Functional Block Diagram

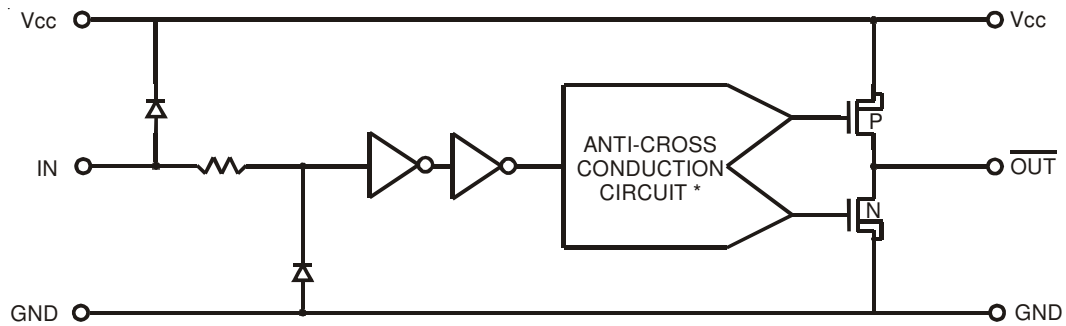
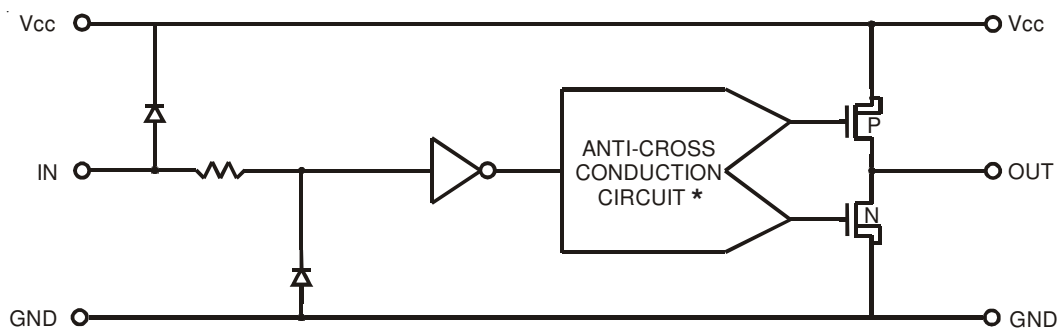

Figure 2 - IXDN514 14A Non-Inverting Gate Driver Functional Block Diagram



* United States Patent 6,917,227

Absolute Maximum Ratings ⁽¹⁾

Parameter	Value
Supply Voltage	35 V
All Other Pins	-0.3 V to $V_{CC} + 0.3V$
Junction Temperature	150 °C
Storage Temperature	-65 °C to 150 °C
Lead Temperature (10 Sec)	300 °C

Operating Ratings ⁽²⁾

Parameter	Value
Operating Supply Voltage	4.5V to 30V
Operating Temperature Range	-55 °C to 125 °C
Package Thermal Resistance*	
8-PinPDIP (PI)	θ_{J-A} (typ) 125 °C/W
8-PinSOIC (SIA)	θ_{J-A} (typ) 200 °C/W
6-LeadDFN (D1)	θ_{J-A} (typ) 125-200 °C/W
6-LeadDFN (D1)	θ_{J-C} (max) 1.5 °C/W
6-LeadDFN (D1)	θ_{J-S} (typ) 5.8 °C/W

Electrical Characteristics @ $T_A = 25\text{ °C}$ ⁽³⁾

Unless otherwise noted, $4.5V \leq V_{CC} \leq 30V$.

All voltage measurements with respect to GND. IXD_514 configured as described in *Test Conditions*.

Symbol	Parameter	Test Conditions	Min	Typ ⁽⁴⁾	Max	Units
V_{IH}	High input voltage	$4.5V \leq V_{CC} \leq 18V$	2.5			V
V_{IL}	Low input voltage	$4.5V \leq V_{CC} \leq 18V$			1.0	V
V_{IN}	Input voltage range		-5		$V_{CC} + 0.3$	V
I_{IN}	Input current	$0V \leq V_{IN} \leq V_{CC}$	-10		10	μA
V_{OH}	High output voltage		$V_{CC} - 0.025$			V
V_{OL}	Low output voltage				0.025	V
R_{OH}	Output resistance @ Output high	$I_{OUT} = 10mA, V_{CC} = 18V$		600	1000	$m\Omega$
R_{OL}	Output resistance @ Output Low	$I_{OUT} = 10mA, V_{CC} = 18V$		600	1000	$m\Omega$
I_{PEAK}	Peak output current	V_{CC} is 18V		14		A
I_{DC}	Continuous output current	Limited by package power dissipation			4	A
t_R	Rise time	$C_L = 15nF, V_{CC} = 18V$	23	25	40	ns
t_F	Fall time	$C_L = 15nF, V_{CC} = 18V$	21	22	50	ns
t_{ONDLY}	On-time propagation delay	$C_L = 15nF, V_{CC} = 18V$	29	30	30	ns
t_{OFFDLY}	Off-time propagation delay	$C_L = 15nF, V_{CC} = 18V$	29	31	50	ns
V_{CC}	Power supply voltage		4.5	18	30	V
I_{CC}	Power supply current	$V_{IN} = 3.5V$		1	3	mA
		$V_{IN} = 0V$		0	10	μA
		$V_{IN} = + V_{CC}$			10	μA

Electrical Characteristics @ temperatures over -55 °C to 125 °C ⁽³⁾

Unless otherwise noted, $4.5V \leq V_{CC} \leq 30V$, $T_j < 150^\circ C$

All voltage measurements with respect to GND. IXD_502 configured as described in *Test Conditions*. All specifications are for one channel.

Symbol	Parameter	Test Conditions	Min	Typ ⁽⁴⁾	Max	Units
V_{IH}	High input voltage	$4.5V \leq V_{CC} \leq 18V$	2.7			V
V_{IL}	Low input voltage	$4.5V \leq V_{CC} \leq 18V$			0.8	V
V_{IN}	Input voltage range		-5		$V_{CC} + 0.3$	V
I_{IN}	Input current	$0V \leq V_{IN} \leq V_{CC}$	-10		10	μA
V_{OH}	High output voltage		$V_{CC} - 0.025$			V
V_{OL}	Low output voltage				0.025	V
R_{OH}	Output resistance @ Output high	$V_{CC} = 18V$			1.25	Ω
R_{OL}	Output resistance @ Output Low	$V_{CC} = 18V$			1.25	Ω
I_{DC}	Continuous output current				1	A
t_R	Rise time	$C_L=10,000pF$ $V_{CC}=18V$		23	100	ns
t_F	Fall time	$C_L=10,000pF$ $V_{CC}=18V$		30	100	ns
t_{ONDLY}	On-time propagation delay	$C_L=10,000pF$ $V_{CC}=18V$		20	60	ns
t_{OFFDLY}	Off-time propagation delay	$C_L=10,000pF$ $V_{CC}=18V$		40	60	ns
V_{CC}	Power supply voltage		4.5	18	30	V
I_{CC}	Power supply current	$V_{IN} = 3.5V$		1	3	mA
		$V_{IN} = 0V$		0	10	μA
		$V_{IN} = + V_{CC}$			10	μA

Notes:

1. Operating the device beyond the parameters listed as "Absolute Maximum Ratings" may cause permanent damage to the device. Exposure to absolute maximum rated conditions for extended periods may affect device reliability.
2. The device is not intended to be operated outside of the Operating Ratings.
3. Electrical Characteristics provided are associated with the stated Test Conditions.
4. Typical values are presented in order to communicate how the device is expected to perform, but not necessarily to highlight any specific performance limits within which the device is guaranteed to function.

* The following notes are meant to define the conditions for the θ_{J-A} , θ_{J-C} and θ_{J-S} values:

- 1) The θ_{J-A} (typ) is defined as junction to ambient. The θ_{J-A} of the standard single die 8-Lead PDIP and 8-Lead SOIC are dominated by the resistance of the package, and the IXD_5XX are typical. The values for these packages are natural convection values with vertical boards and the values would be lower with natural convection. For the 6-Lead DFN package, the θ_{J-A} value supposes the DFN package is soldered on a PCB. The θ_{J-A} (typ) is 200 °C/W with no special provisions on the PCB, but because the center pad provides a low thermal resistance to the die, it is easy to reduce the θ_{J-A} by adding connected copper pads or traces on the PCB. These can reduce the θ_{J-A} (typ) to 125 °C/W easily, and potentially even lower. The θ_{J-A} for DFN on PCB without heatsink or thermal management will vary significantly with size, construction, layout, materials, etc. This typical range tells the user what he is likely to get if he does no thermal management.
- 2) θ_{J-C} (max) is defined as junction to case, where case is the large pad on the back of the DFN package. The θ_{J-C} values are generally not published for the PDIP and SOIC packages. The θ_{J-C} for the DFN packages are important to show the low thermal resistance from junction to the die attach pad on the back of the DFN, -- and a guardband has been added to be safe.
- 3) The θ_{J-S} (typ) is defined as junction to heatsink, where the DFN package is soldered to a thermal substrate that is mounted on a heatsink. The value must be typical because there are a variety of thermal substrates. This value was calculated based on easily available IMS in the U.S. or Europe, and not a premium Japanese IMS. A 4 mil dielectric with a thermal conductivity of 2.2W/mC was assumed. The result was given as typical, and indicates what a user would expect on a typical IMS substrate, and shows the potential low thermal resistance for the DFN package.

Pin Description

SYMBOL	FUNCTION	DESCRIPTION
VCC	Supply Voltage	Positive power-supply voltage input. This pin provides power to the entire chip. The range for this voltage is from 4.5V to 30V.
IN	Input	Input signal-TTL or CMOS compatible.
OUT	Output	Driver Output. For application purposes, this pin is connected, through a resistor, to Gate of a MOSFET/IGBT.
GND	Ground	The system ground pin. Internally connected to all circuitry, this pin provides ground reference for the entire chip. This pin should be connected to a low noise analog ground plane for optimum performance.

CAUTION: Follow proper ESD procedures when handling and assembling this component.

Figure 3 - Characteristics Test Diagram

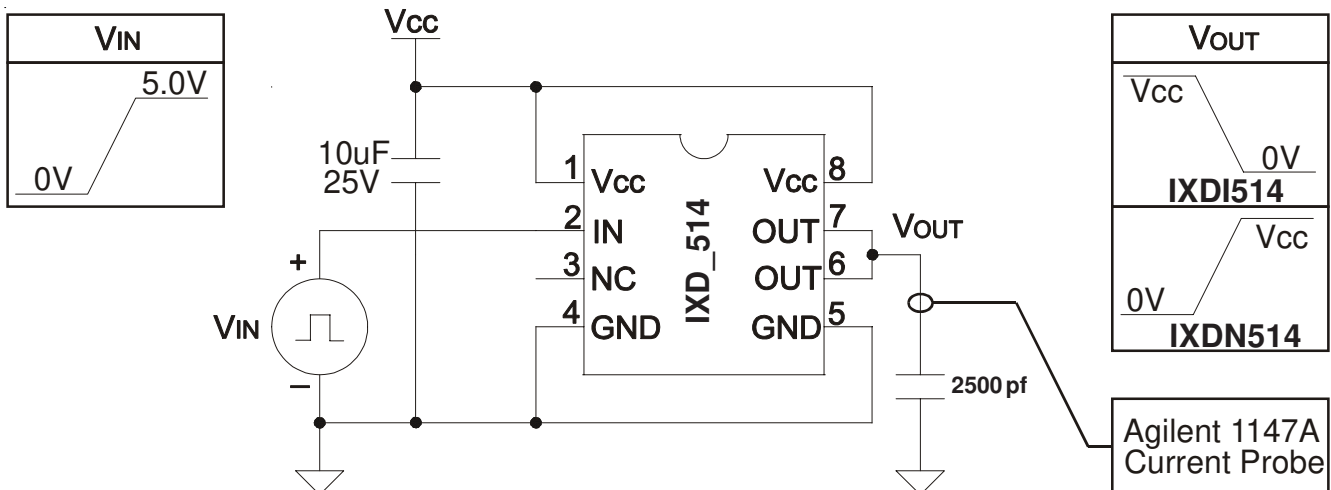
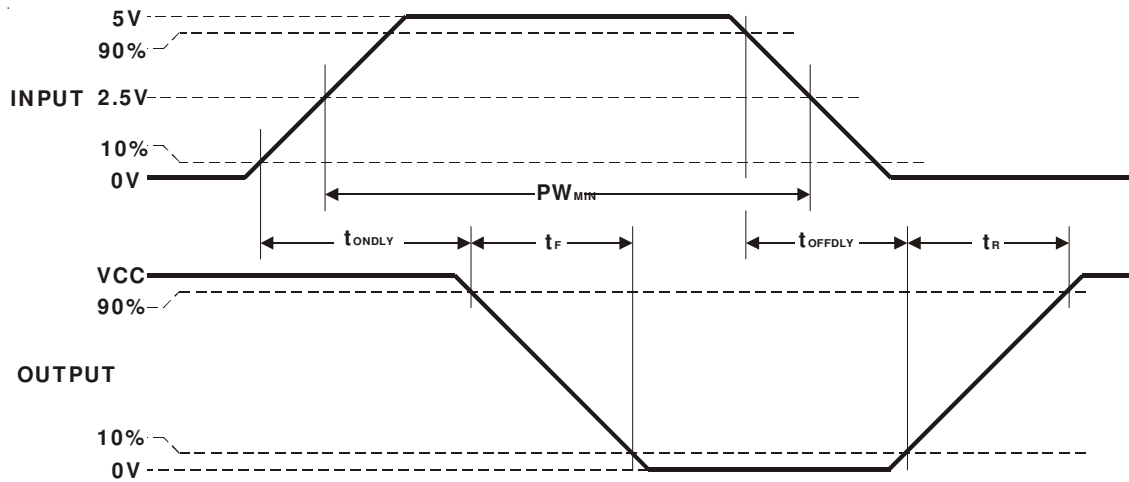
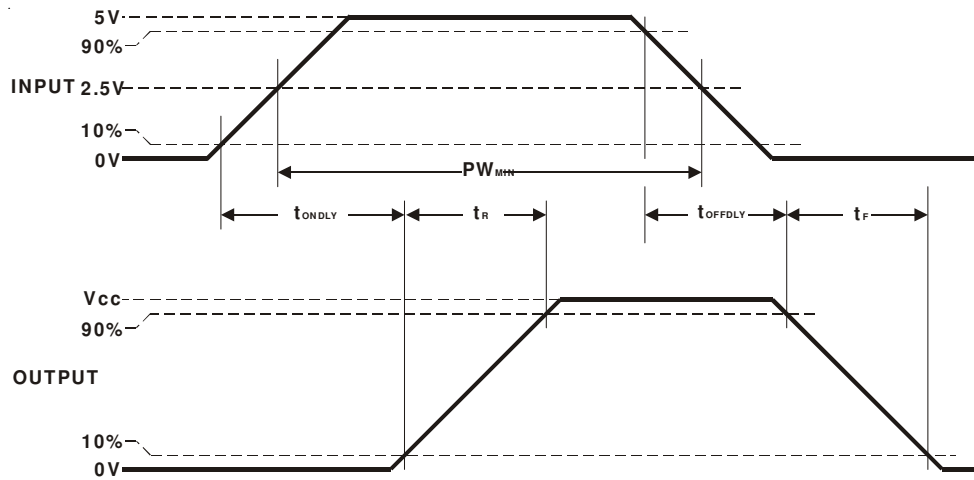

Figure 4 - Timing Diagrams
Inverting (IXDI514) Timing Diagram

Non-Inverting (IXDN514) Timing Diagram

Typical Performance Characteristics

Fig. 11 Supply Current vs. Load Capacitance
 $V_{CC}=18V$

Fig. 12 Supply Current vs. Frequency
 $V_{CC}=18V$

Fig. 13 Supply Current vs. Load Capacitance
 $V_{CC}=12V$

Fig. 14 Supply Current vs. Frequency
 $V_{CC}=12V$

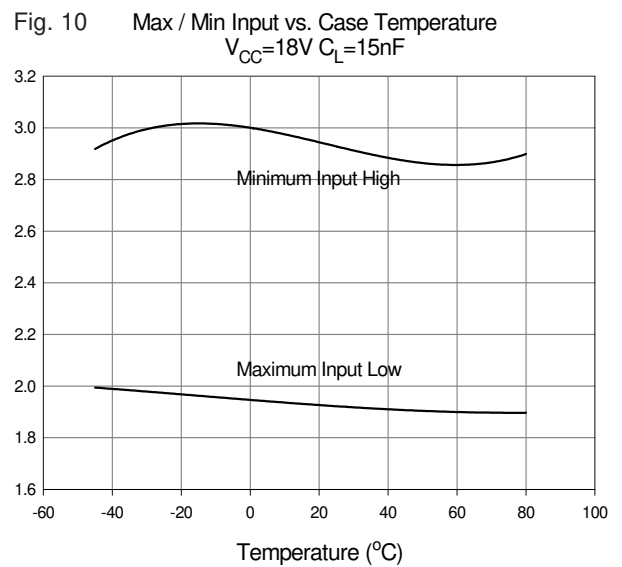
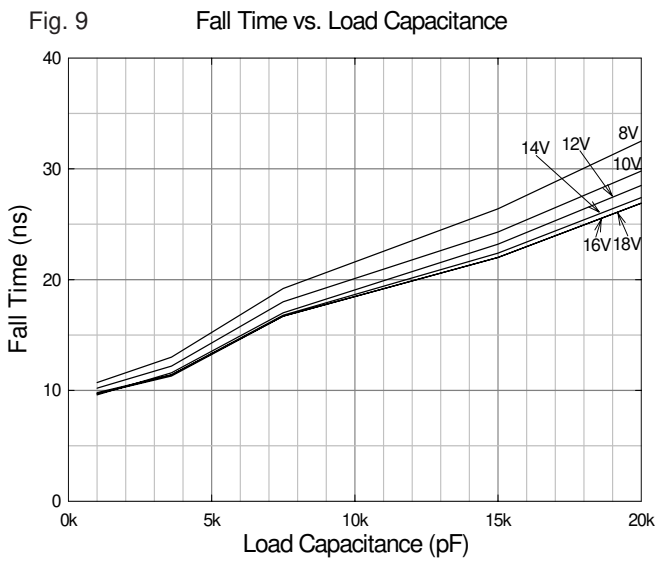
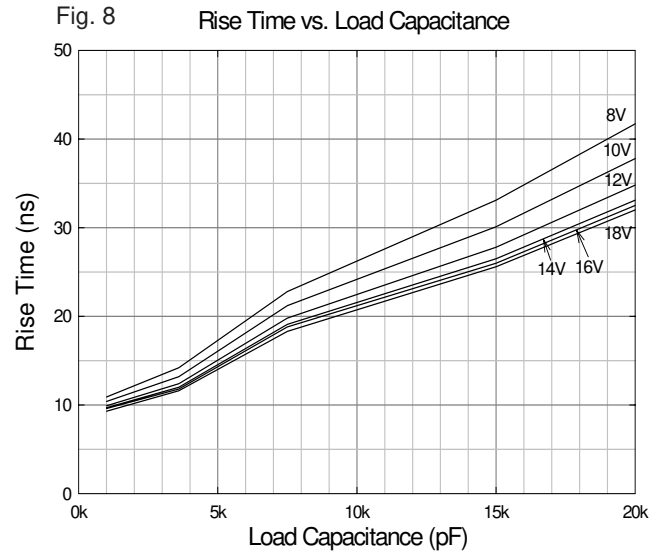
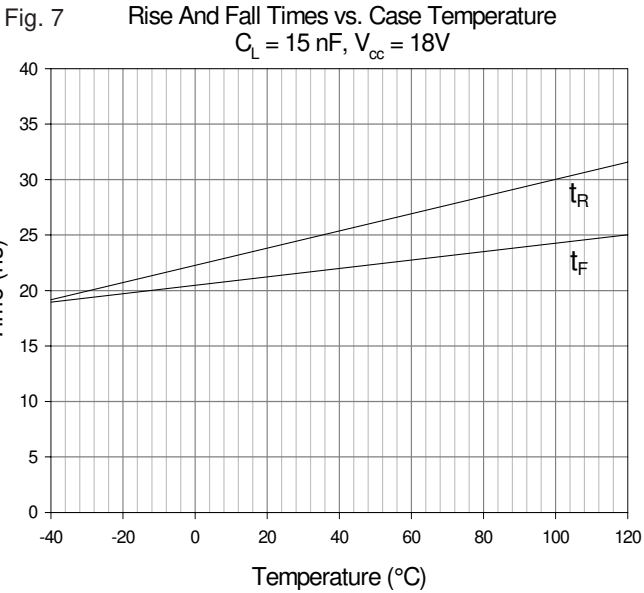
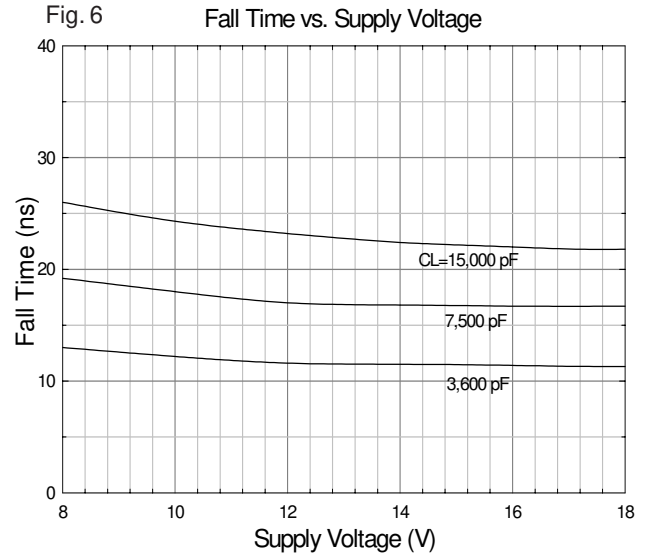
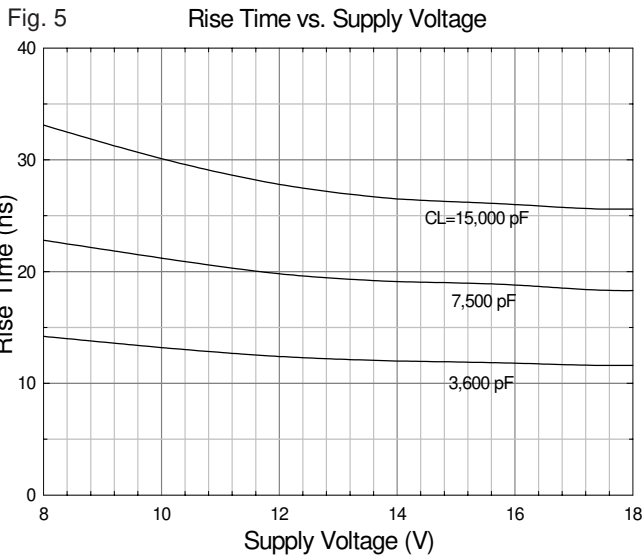
Fig. 15 Supply Current vs. Load Capacitance
 $V_{CC}=8V$

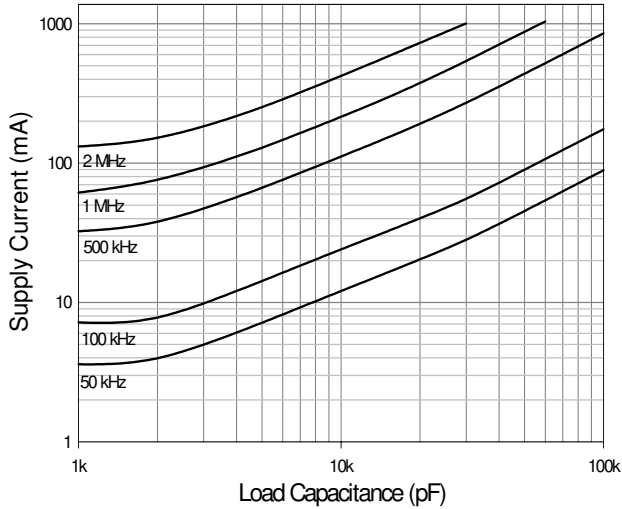
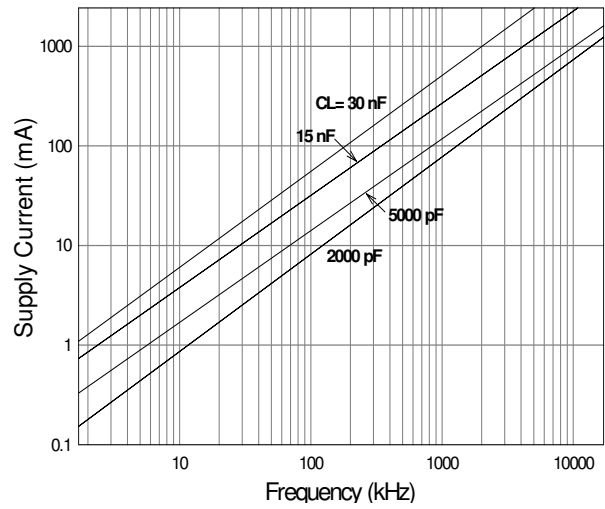
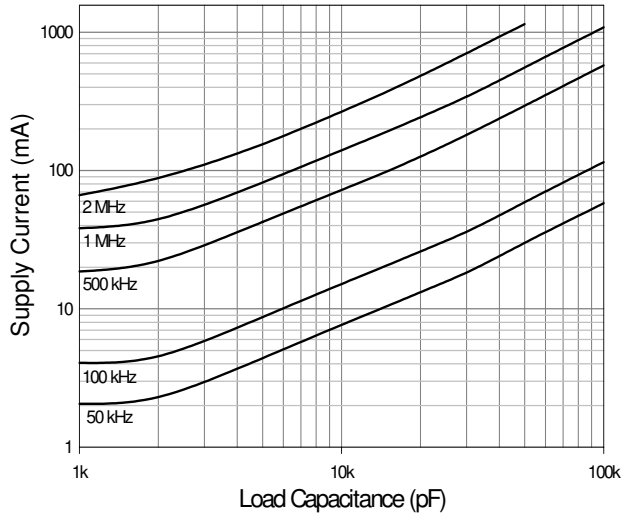
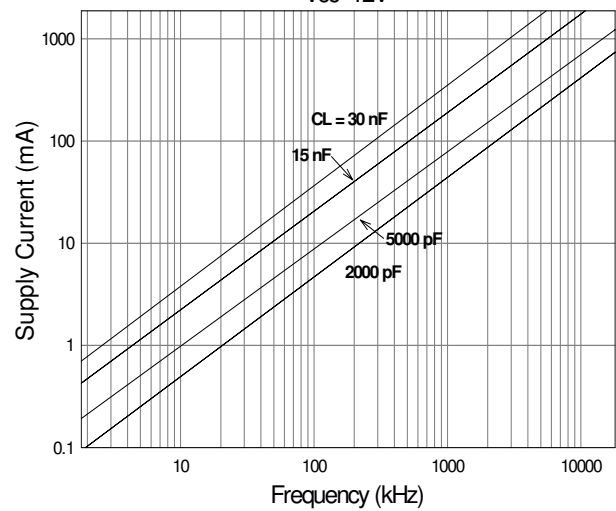
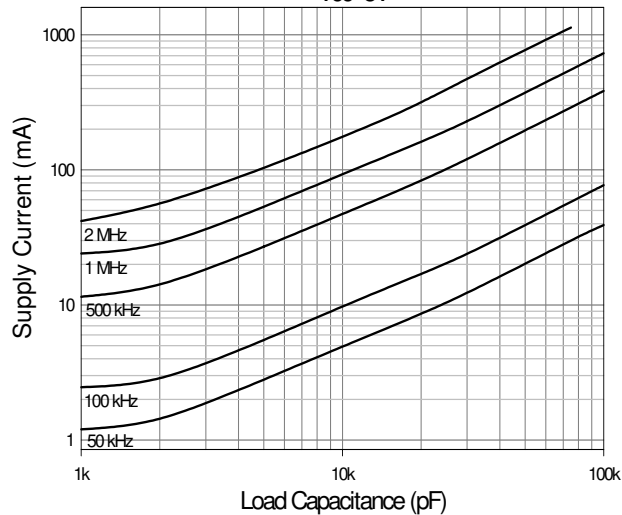
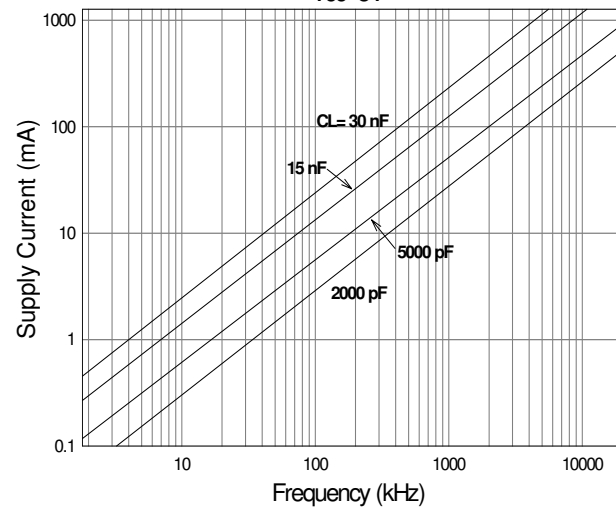
Fig. 16 Supply Current vs. Frequency
 $V_{CC}=8V$

Fig. 17 Propagation Delay vs. Supply Voltage
 $C_L = 15\text{nF}$ $V_{IN} = 5\text{V}@1\text{kHz}$

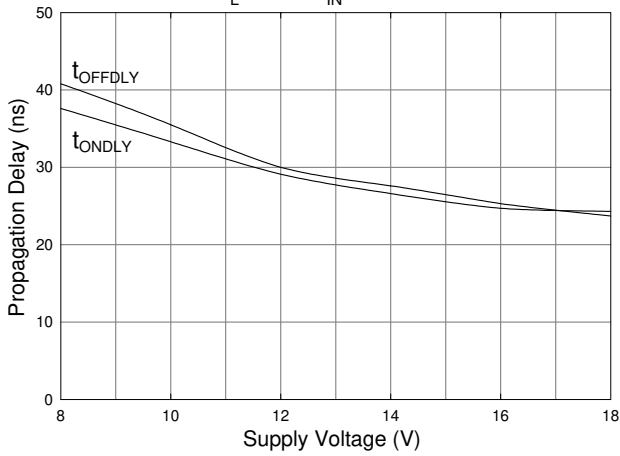

Fig. 18 Propagation Delay vs. Input Voltage
 $C_L = 15\text{nF}$ $V_{CC} = 15\text{V}$

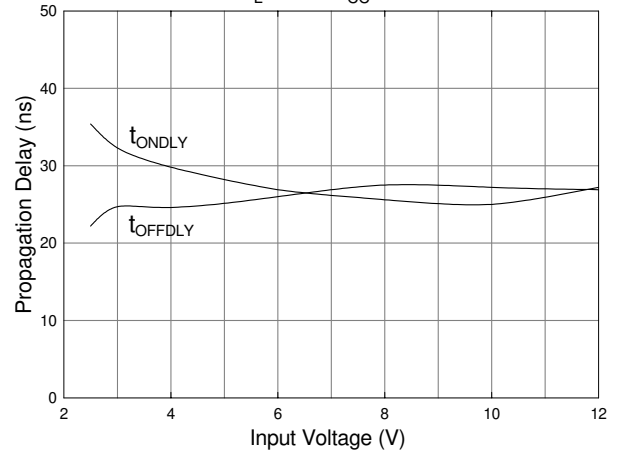

Fig. 19 Propagation Delay vs. Case Temperature
 $C_L = 2500\text{pF}$, $V_{CC} = 18\text{V}$

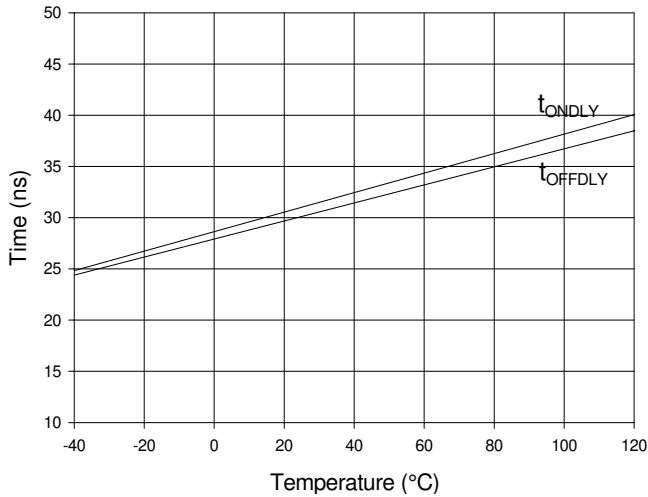

Fig. 20 Quiescent Supply Current vs. Case Temperature
 $V_{CC} = 18\text{V}$ $V_{IN} = 5\text{V}@1\text{kHz}$

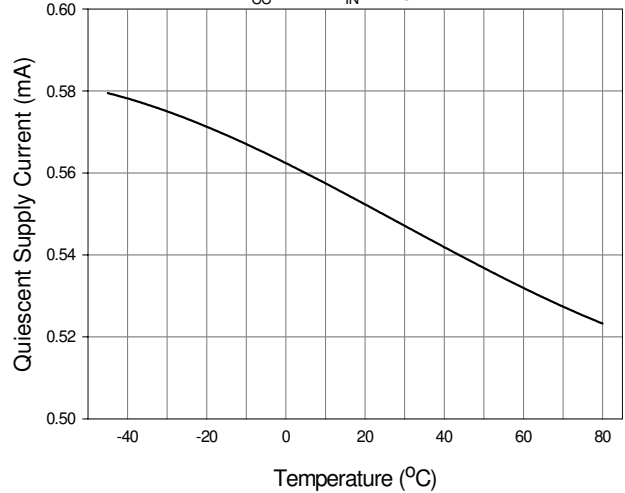

Fig. 21 P Channel Output Current vs. Case Temperature
 $V_{CC} = 18\text{V}$ $C_L = 1\mu\text{F}$

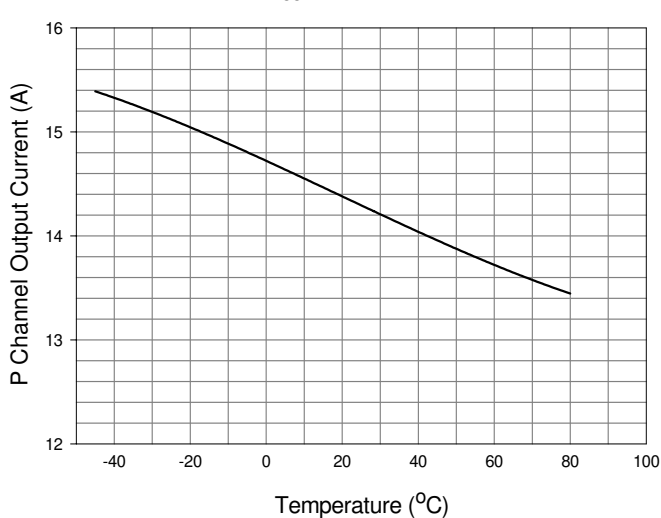

Fig. 22 N Channel Output Current vs. Case Temperature
 $V_{CC} = 18\text{V}$ $C_L = 1\mu\text{F}$

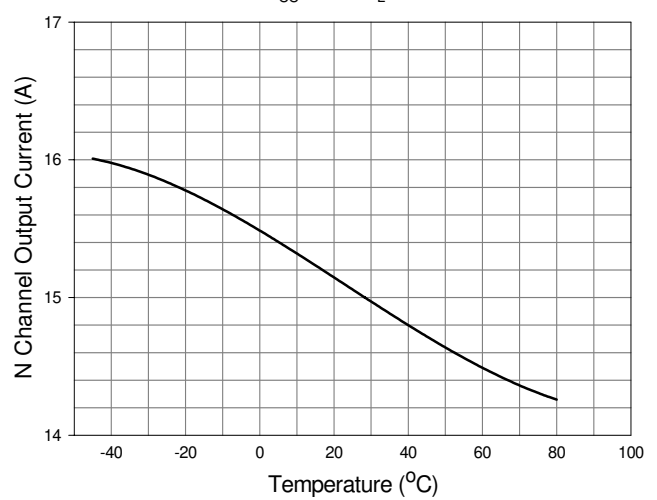
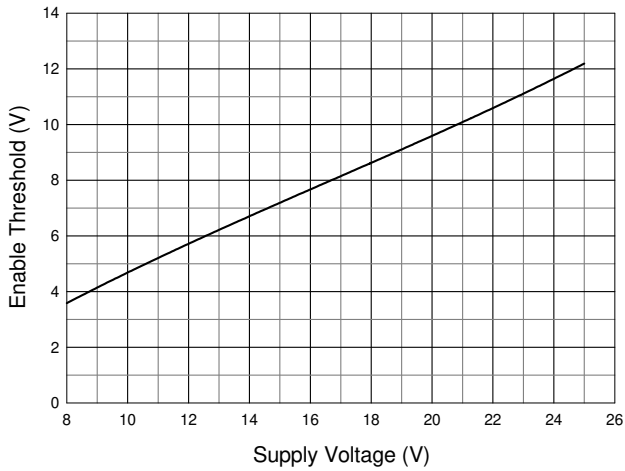
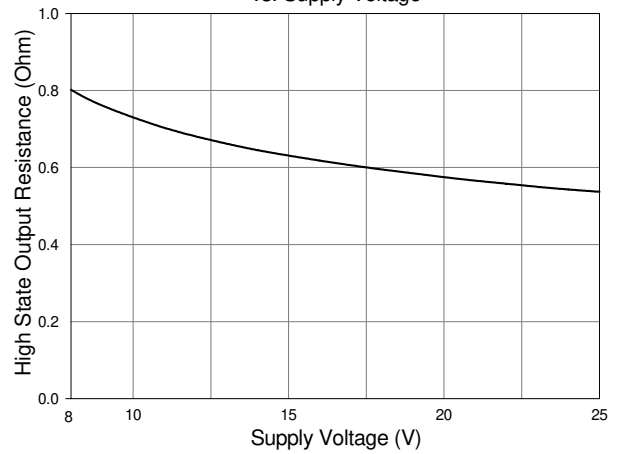
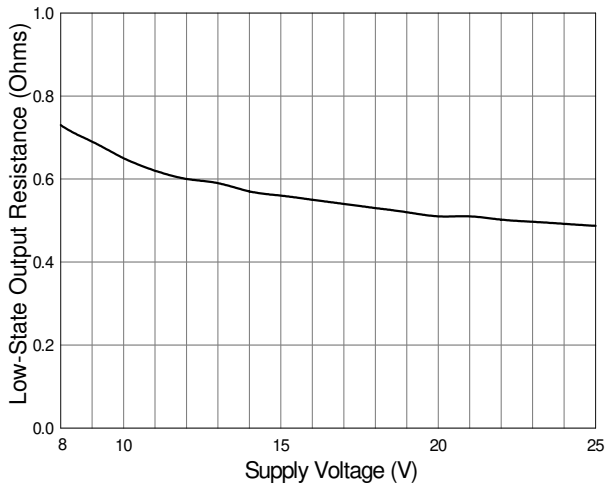
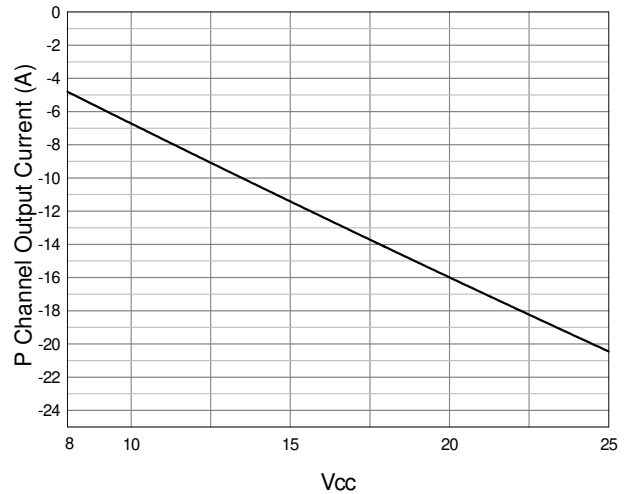
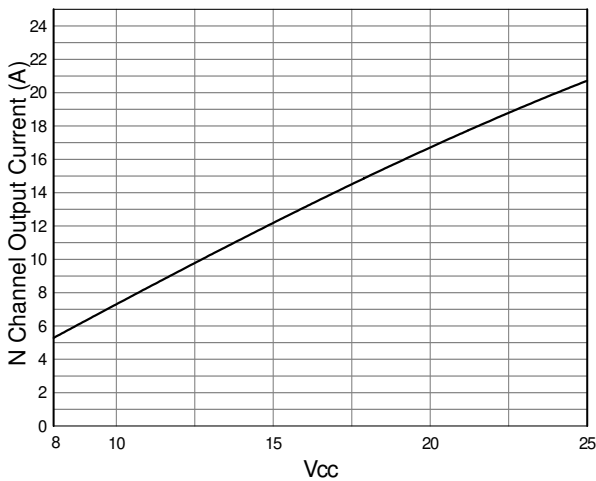
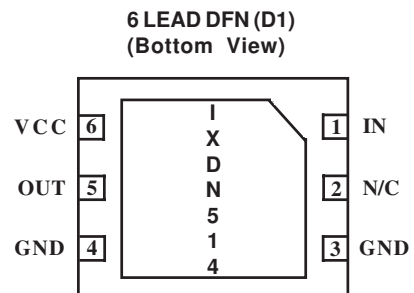
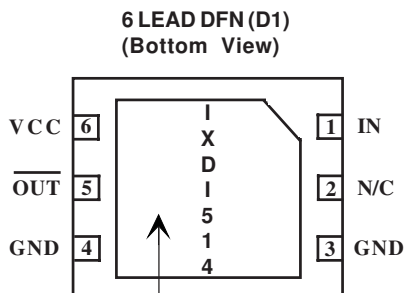
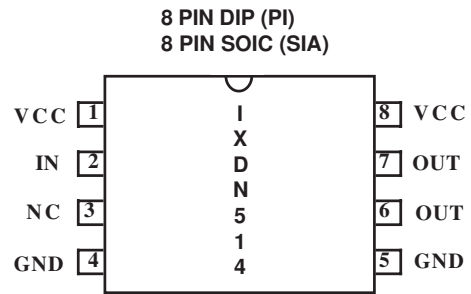
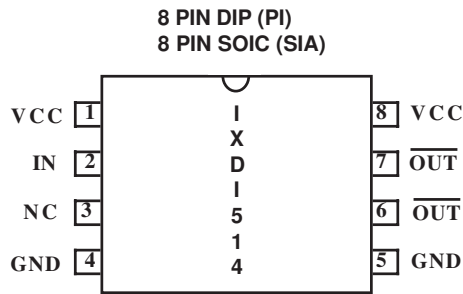

Fig. 23 Enable Threshold vs. Supply Voltage

Fig. 24 High State Output Resistance vs. Supply Voltage

Fig. 25 Low-State Output Resistance vs. Supply Voltage

Fig. 26 V_{CC} vs. P Channel Output Current
 $C_L = .1\mu F$ $V_{IN} = 0-5V@1kHz$

Fig. 27 Vcc vs. N Channel Output Current
 $C_L = .1\mu F$ $V_{IN} = 0-5V@1kHz$

PIN CONFIGURATIONS

NOTE: Solder tabs on bottoms of DFN packages are grounded

Supply Bypassing, Grounding Practices And Output Lead inductance

When designing a circuit to drive a high speed MOSFET utilizing the IXD_514, it is very important to observe certain design criteria in order to optimize performance of the driver. Particular attention needs to be paid to **Supply Bypassing**, **Grounding**, and minimizing the **Output Lead Inductance**.

Say, for example, we are using the IXD_514 to charge a 5000pF capacitive load from 0 to 25 volts in 25ns.

Using the formula: $I = \Delta V C / \Delta t$, where $\Delta V = 25V$, $C = 5000pF$ & $\Delta t = 25ns$, we can determine that to charge 5000pF to 25 volts in 25ns will take a constant current of 5A. (In reality, the charging current won't be constant, and will peak somewhere around 8A).

SUPPLY BYPASSING

In order for our design to turn the load on properly, the IXD_514 must be able to draw this 5A of current from the power supply in the 25ns. This means that there must be very low impedance between the driver and the power supply. The most common method of achieving this low impedance is to bypass the power supply at the driver with a capacitance value that is an order of magnitude larger than the load capacitance. Usually, this would be achieved by placing two different types of bypassing capacitors, with complementary impedance curves, very close to the driver itself. (These capacitors should be carefully selected and should have low inductance, low resistance and high-pulse current-service ratings). Lead lengths may radiate at high frequency due to inductance, so care should be taken to keep the lengths of the leads between these bypass capacitors and the IXD_514 to an absolute minimum.

GROUNDING

In order for the design to turn the load off properly, the IXD_514 must be able to drain this 5A of current into an adequate grounding system. There are three paths for returning current that need to be considered: Path #1 is between the IXD_514 and its load. Path #2 is between the IXD_514 and its power supply. Path #3 is between the IXD_514 and whatever logic is driving it. All three of these paths should be as low in resistance and inductance as possible, and thus as short as practical. In addition, every effort should be made to keep these three ground paths distinctly separate. Otherwise, the returning ground current from the load may develop a voltage that would have a detrimental effect on the logic line driving the IXD_514.

OUTPUT LEAD INDUCTANCE

Of equal importance to Supply Bypassing and Grounding are issues related to the Output Lead Inductance. Every effort should be made to keep the leads between the driver and its load as short and wide as possible. If the driver must be placed farther than 2" (5mm) from the load, then the output leads should be treated as transmission lines. In this case, a twisted-pair should be considered, and the return line of each twisted pair should be placed as close as possible to the ground pin of the driver, and connected directly to the ground terminal of the load.

PRELIMINARY TECHNICAL INFORMATION

The product presented herein is under development. The Technical Specifications offered are derived from data gathered during objective characterizations of preliminary engineering lots; but also may yet contain some information supplied during a pre-production design evaluation. IXYS reserves the right to change limits, test conditions, and dimensions without notice.

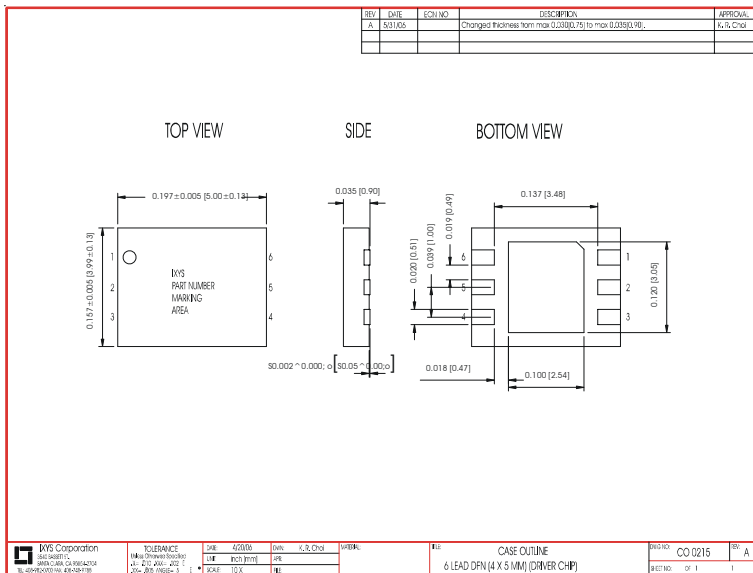
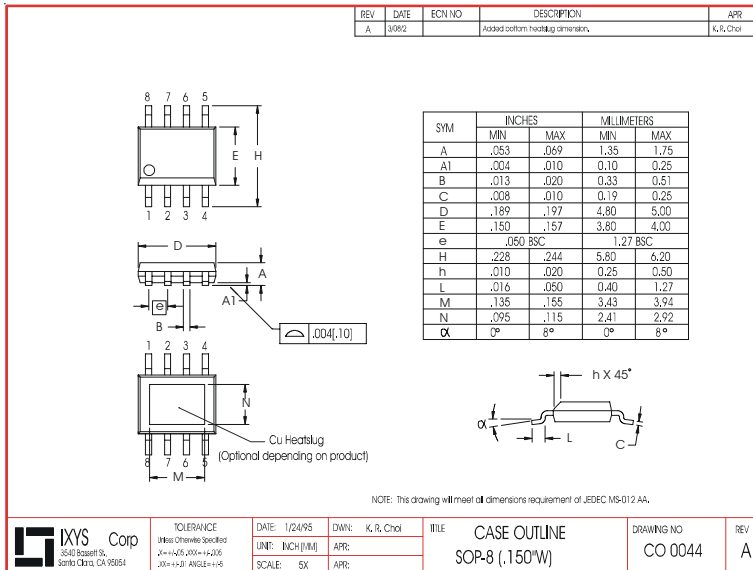
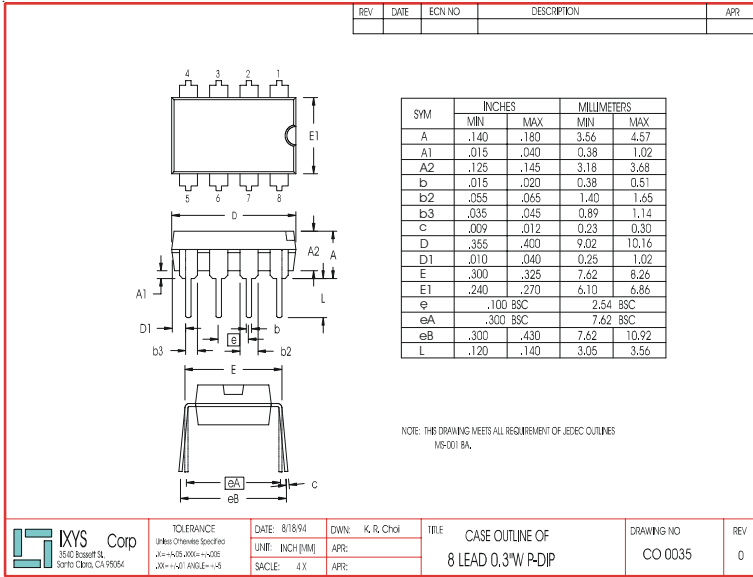

IXYS Corporation
3540 Bassett St; Santa Clara, CA 95054
Tel: 408-982-0700; Fax: 408-496-0670
e-mail: sales@ixys.net
www.ixys.com

IXYS Semiconductor GmbH
Edisonstrasse 15 ; D-68623; Lampertheim
Tel: +49-6206-503-0; Fax: +49-6206-503627
e-mail: marcom@ixys.de