



Chipsmall Limited consists of a professional team with an average of over 10 year of expertise in the distribution of electronic components. Based in Hongkong, we have already established firm and mutual-benefit business relationships with customers from,Europe,America and south Asia,supplying obsolete and hard-to-find components to meet their specific needs.

With the principle of “Quality Parts,Customers Priority,Honest Operation,and Considerate Service”,our business mainly focus on the distribution of electronic components. Line cards we deal with include Microchip,ALPS,ROHM,Xilinx,Pulse,ON,Everlight and Freescale. Main products comprise IC,Modules,Potentiometer,IC Socket,Relay,Connector.Our parts cover such applications as commercial,industrial, and automotives areas.

We are looking forward to setting up business relationship with you and hope to provide you with the best service and solution. Let us make a better world for our industry!



Contact us

Tel: +86-755-8981 8866 Fax: +86-755-8427 6832

Email & Skype: info@chipsmall.com Web: www.chipsmall.com

Address: A1208, Overseas Decoration Building, #122 Zhenhua RD., Futian, Shenzhen, China



High Voltage IGBT with optional Diode ISOPLUS™ package

(Electrically Isolated Back Side)

$V_{CES} = 1200\text{ V}$
 $I_{C25} = 50\text{ A}$
 $V_{CE(sat) typ} = 2.4\text{ V}$

Short Circuit SOA Capability
Square RBSOA

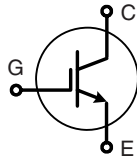

IXDR 30N120

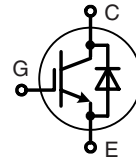

IXDR 30N120 D1

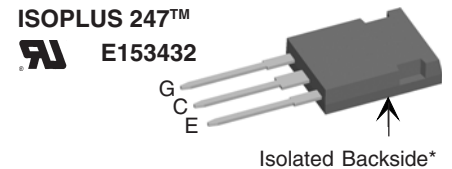

G = Gate C = Collector E = Emitter

Symbol	Conditions	Maximum Ratings
V_{CES}	$T_J = 25^\circ\text{C}$ to 150°C	1200 V
V_{CGR}	$T_J = 25^\circ\text{C}$ to 150°C ; $R_{GE} = 20\text{ k}\Omega$	1200 V
V_{GES}	Continuous	± 20 V
V_{GEM}	Transient	± 30 V
I_{C25}	$T_C = 25^\circ\text{C}$	50 A
I_{C90}	$T_C = 90^\circ\text{C}$	30 A
I_{CM}	$T_C = 90^\circ\text{C}$, $t_p = 1\text{ ms}$	60 A
RBSOA	$V_{GE} = \pm 15\text{ V}$, $T_J = 125^\circ\text{C}$, $R_G = 47\ \Omega$ Clamped inductive load, $L = 30\text{ mH}$	$I_{CM} = 50\text{ A}$ $V_{CEK} < V_{CES}$
t_{SC} (SCSOA)	$V_{GE} = \pm 15\text{ V}$, $V_{CE} = V_{CES}$, $T_J = 125^\circ\text{C}$ $R_G = 47\ \Omega$, non repetitive	10 μs
P_C	$T_C = 25^\circ\text{C}$	IGBT: 200 W Diode: 95 W
T_J		-55 ... +150 $^\circ\text{C}$
T_{stg}		-55 ... +150 $^\circ\text{C}$
V_{ISOL}	50/60 Hz, RMS $I_{ISOL} \leq 1\text{ mA}$	2500 V~
Weight		6 g

Features

- NPT IGBT technology
- high switching speed
- low switching losses
- square RBSOA, no latch up
- high short circuit capability
- positive temperature coefficient for easy paralleling
- MOS input, voltage controlled
- fast recovery epitaxial diode
- Epoxy meets UL 94V-0
- Isolated and UL registered E153432

Advantages

- DCB Isolated mounting tab
- Meets TO-247AD package Outline
- Package for clip or spring mounting
- Space savings
- High power density

Typical Applications

- AC motor speed control
- DC servo and robot drives
- DC choppers
- Uninterruptible power supplies (UPS)
- Switch-mode and resonant-mode power supplies

Symbol	Conditions	Characteristic Values ($T_J = 25^\circ\text{C}$, unless otherwise specified)		
		min.	typ.	max.
$V_{(BR)CES}$	$V_{GE} = 0\text{ V}$	1200		V
$V_{GE(th)}$	$I_C = 1\text{ mA}$, $V_{CE} = V_{GE}$	4.5		V
I_{CES}	$V_{CE} = V_{CES}$, $T_J = 25^\circ\text{C}$ $T_J = 125^\circ\text{C}$		2.5	1.5 mA mA
I_{GES}	$V_{CE} = 0\text{ V}$, $V_{GE} = \pm 20\text{ V}$			$\pm 500\text{ nA}$
$V_{CE(sat)}$	$I_C = 30\text{ A}$, $V_{GE} = 15\text{ V}$	2.4	2.9	V

Symbol	Conditions	Characteristic Values		
		(T _J = 25°C, unless otherwise specified)		
		min.	typ.	max.
C _{ies}	V _{CE} = 25 V, V _{GE} = 0 V, f = 1 MHz		1650	pF
C _{oes}			250	pF
C _{res}			110	pF
Q _g	I _C = 30 A, V _{GE} = 15 V, V _{CE} = 0.5 V _{CES}		120	nC
t _{d(on)}	Inductive load, T _J = 125°C I _C = 30 A, V _{GE} = ±15 V, V _{CE} = 600 V, R _G = 47 Ω		100	ns
t _r			70	ns
t _{d(off)}			500	ns
t _f			70	ns
E _{on}			4.6	mJ
E _{off}		3.4	mJ	
R _{thJC}				0.6 K/W
R _{thCH}	Package with heatsink compound		0.25	K/W

Symbol	Conditions	Characteristic Values		
		(T _J = 25°C, unless otherwise specified)		
		min.	typ.	max.
V _F	I _F = 30 A, V _{GE} = 0 V		2.5	2.75 V
	I _F = 30 A, V _{GE} = 0 V, T _J = 125°C		2.0	V
I _F	T _C = 25°C			50 A
	T _C = 90°C			27 A
I _{RM}	I _F = 30 A, -di _F /dt = 400 A/μs, V _R = 600 V		20	A
t _{rr}	V _{GE} = 0 V, T _J = 125°C		200	ns
t _{rr}	I _F = 1 A, -di _F /dt = 100 A/μs, V _R = 30 V, V _{GE} = 0 V		40	ns
R _{thJC}				1.3 K/W

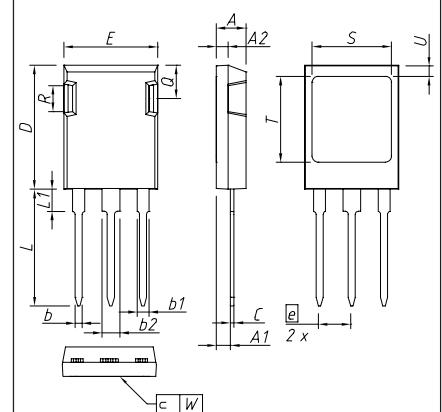
ISOPLUS247™ OUTLINE

DIM.	MILLIMETER		INCHES	
	MIN	MAX	MIN	MAX
A	4,83	5,21	0,190	0,205
A1	2,29	2,54	0,090	0,100
A2	1,91	2,16	0,075	0,085
b	1,14	1,40	0,045	0,055
b1	1,91	2,15	0,075	0,085
b2	2,92	3,20	0,115	0,126
c	0,61	0,83	0,024	0,033
D	20,80	21,34	0,819	0,840
E	15,75	16,13	0,620	0,635
e	5,45 BSC		0,215 BSC	
L	19,81	20,60	0,780	0,811
L1	3,81	4,38	0,150	0,172
Q	5,59	6,20	0,220	0,244
R	4,32	4,85	0,170	0,191
S	13,21	13,72	0,520	0,540
T	15,75	16,26	0,620	0,640
U	1,65	2,03	0,065	0,080
W	-	0,10	-	0,004

The convex bow of substrate is typ. < 0.04 mm over plastic surface level of device bottom side
 This drawing will meet all dimensions requirement of JEDEC outline TO-247 AD except screw hole and except Lmax.

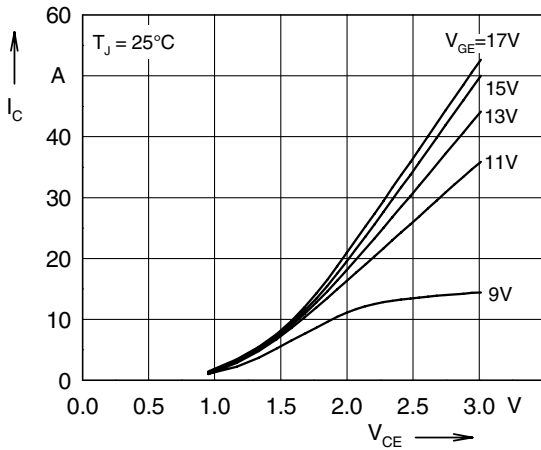

Fig. 1 Typ. output characteristics

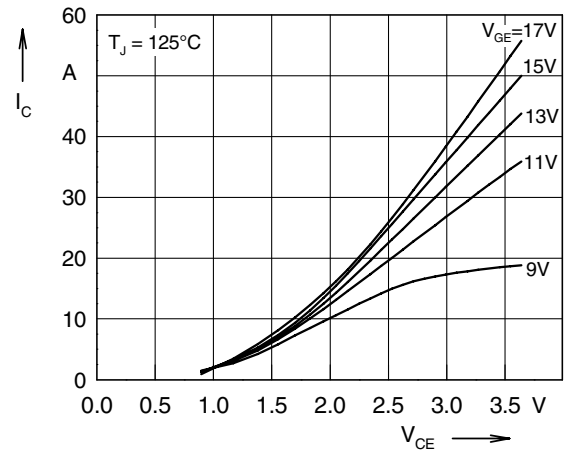

Fig. 2 Typ. output characteristics

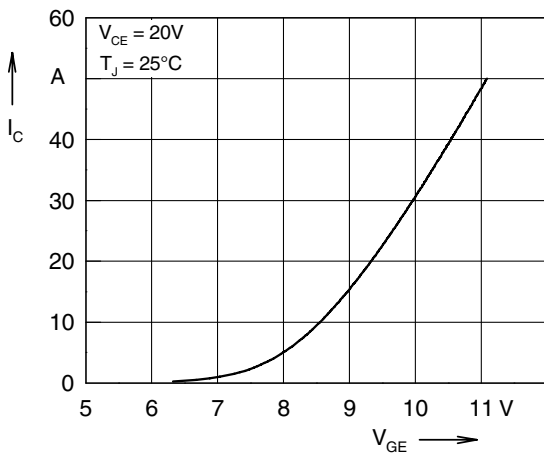

Fig. 3 Typ. transfer characteristics

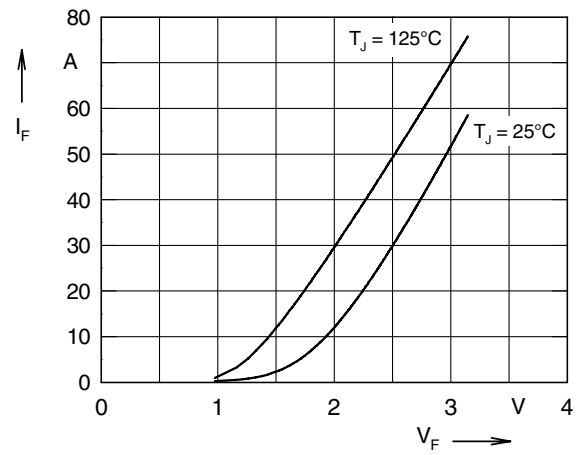

Fig. 4 Typ. forward characteristics of free wheeling diode

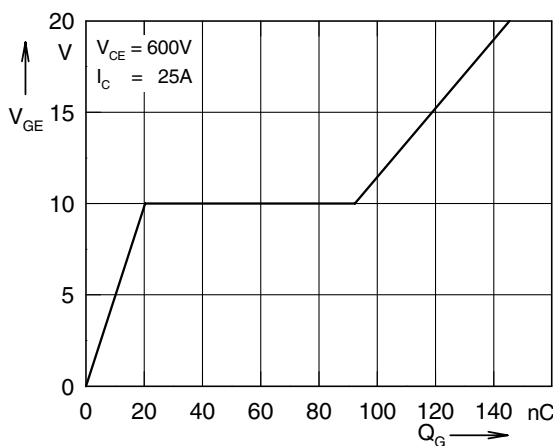

Fig. 5 Typ. turn on gate charge

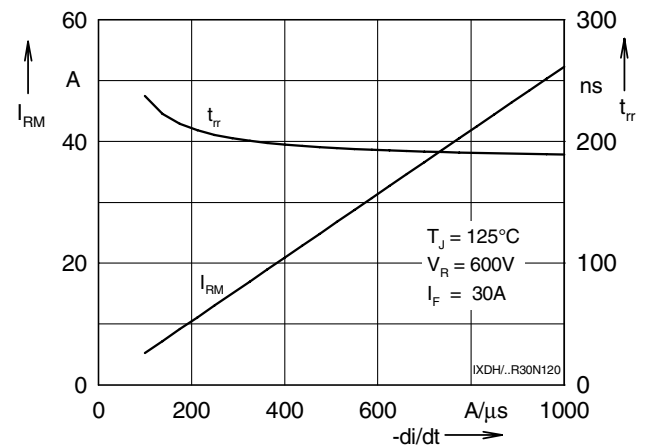

Fig. 6 Typ. turn off characteristics of free wheeling diode

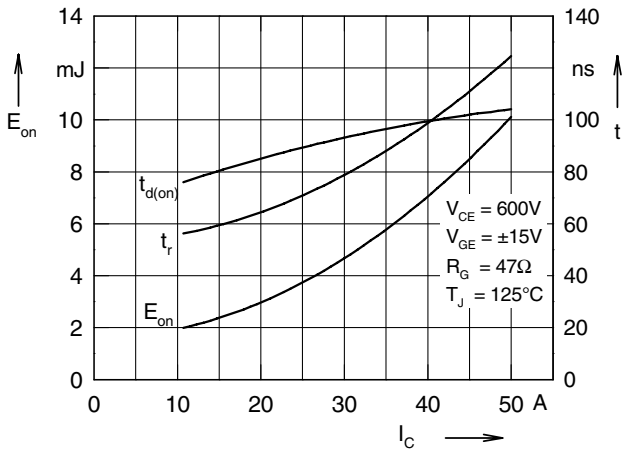

Fig. 7 Typ. turn on energy and switching times versus collector current

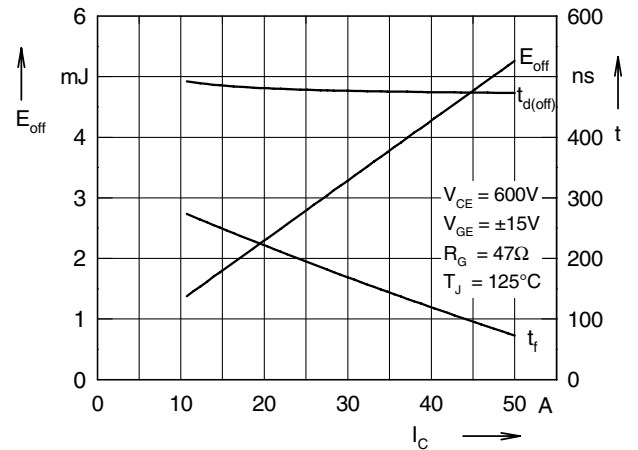

Fig. 8 Typ. turn off energy and switching times versus collector current

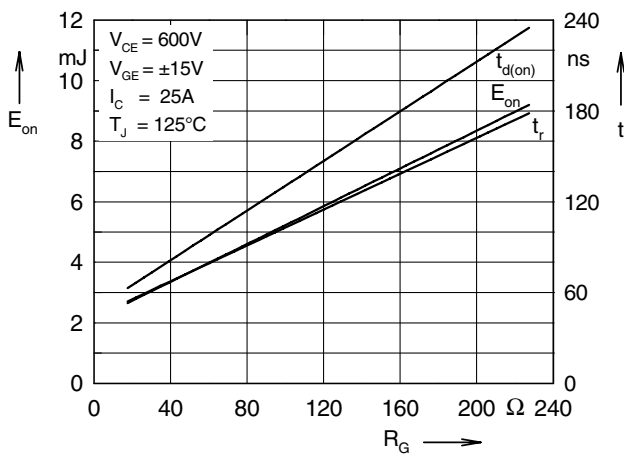

Fig. 9 Typ. turn on energy and switching times versus gate resistor

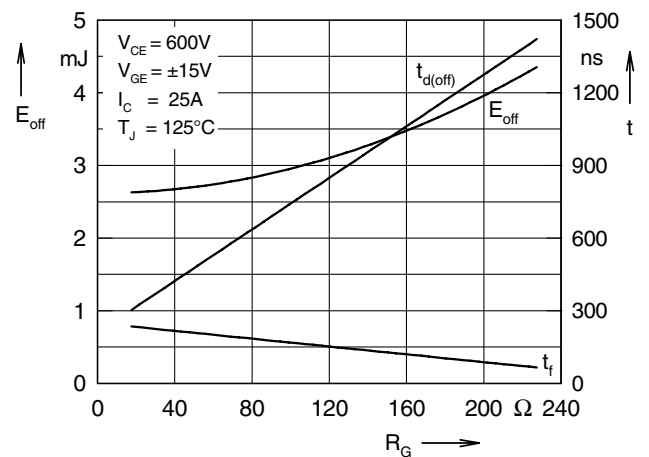

Fig. 10 Typ. turn off energy and switching times versus gate resistor

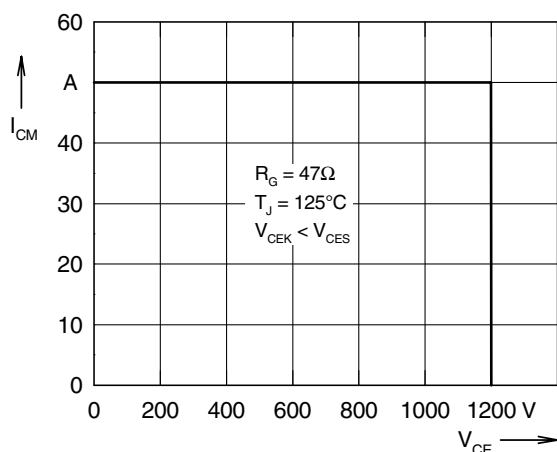

Fig. 11 Reverse biased safe operating area RBSOA

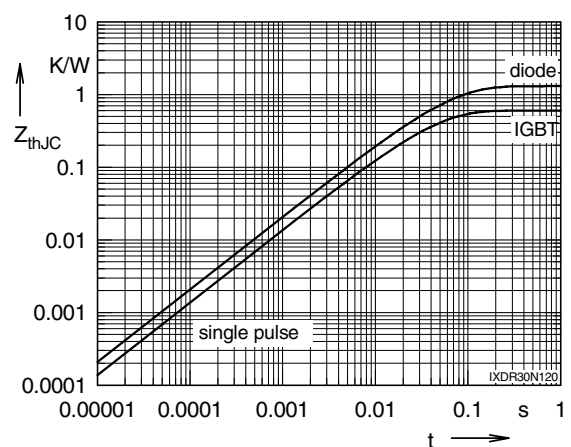

Fig. 12 Typ. transient thermal impedance